

SONY®

2-663-957-11 (1)

D-NE331CK/NE336CK

Operating Instructions

ATRAC CD Walkman

Portable CD Player



ATRAC



WARNING

To reduce the risk of fire or electric shock, do not expose this apparatus to rain or moisture.

Do not install the appliance in a confined space, such as a bookcase or built-in cabinet.

To reduce the risk of fire, do not cover the ventilation of the apparatus with newspapers, table-cloths, curtains, etc. And do not place lighted candles on the apparatus.

To reduce the risk of fire or electric shock, do not place objects filled with liquids, such as vases, on the apparatus.

CAUTION

The use of optical instruments with this product will increase eye hazard.

Certain countries may regulate disposal of the battery used to power this product. Please consult with your local authority.

CAUTION

- INVISIBLE LASER RADIATION WHEN OPEN
- DO NOT STARE INTO BEAM OR VIEW DIRECTLY WITH OPTICAL INSTRUMENTS
- CLASS 1M INVISIBLE LASER RADIATION WHEN OPEN
- DO NOT VIEW DIRECTLY WITH OPTICAL INSTRUMENTS

The validity of the CE marking is restricted to only those countries where it is legally enforced, mainly in the countries EEA (European Economic Area).

Owner's Record

The model number and the serial number are located at the rear of the CD player. Record these numbers in the spaces provided below. Refer to them whenever you call upon your Sony dealer regarding this product.

Model No. _____

Serial No. _____

For customers who purchased this product in the USA

Product registration

Please register this product on line at www.sony.com/walkmanreg
<<http://www.sony.com/walkmanreg>>

Proper registration will enable us to send you periodic mailings about software upgrades, new products, services and other important announcements. Thank you.

If you have any questions about this product, contact:

www.sony.com/walkmansupport

**Sony Network Portable Audio Support Line
1-(866)-456-7669**

**Sony Customer Information Services Center
12451 Gateway Blvd., Ft. Myers, FL 33913**

Note:

This equipment has been tested and found to comply with the limits for a Class B digital device, pursuant to Part 15 of the FCC Rules. These limits are designed to provide reasonable protection against harmful interference in a residential installation. This equipment generates, uses, and can radiate radio frequency energy and, if not installed and used in accordance with the instructions, may cause harmful interference to radio communications. However, there is no guarantee that interference will not occur in a particular installation. If this equipment does cause harmful interference to radio or television reception, which can be determined by turning the equipment off and on, the user is encouraged to try to correct the interference by one or more of the following measures:

- Reorient or relocate the receiving antenna.
- Increase the separation between the equipment and receiver.
- Connect the equipment into an outlet on a circuit different from that to which the receiver is connected.
- Consult the dealer or an experienced radio/TV technician for help.

You are cautioned that any changes or modifications not expressly approved in this manual could void your authority to operate this equipment.

Table of Contents

Create Your Own ATRAC CDs	4
Which discs can you play on this CD player?	5
Precautions	7
On safety	7
On the CD player	7
On handling CDs	7
On headphones/earphones	7

Getting Started

Checking the Supplied Accessories	8
Guide to Parts and Controls	9
Installing in a Car	10
Where to place your CD player	10
Mounting your CD player	10
Replacing the fuse of the car battery cord.....	11
Mounting the rotary commander.....	12
Preparing a Power Source (Dry Battery)	13
Checking the remaining power of the battery.....	13
When using the AC power adaptor.....	14

Playback

Playing a CD	15
Basic playback operations (Play, stop, search).....	16
Locking the controls (HOLD)	17
Searching for Your Favorite Track/File	17
Searching by viewing groups (File View).....	17
Searching by viewing a list of groups/files (List View)	18
Checking CD information on the display	18

Changing Playback Options (PLAY MODE)	20
Playback options (PLAY MODE)	21
Playing groups.....	22
Playing your favorite tracks (Bookmark play).....	22
Playing your favorite play lists (m3u play list play).....	22
Playing tracks in your favorite order (PGM play).....	23
Playing tracks repeatedly (Repeat play)	23
Changing Sound Quality	24
Selecting the sound quality	24
Customizing sound quality	24
SOUND items	25
Changing Optional Settings	26
Setting various functions	26
OPTION items	27

Additional Information

Troubleshooting	29
Maintenance	32
Specifications	32
Optional Accessories	33
SonicStage Download Website	33
Index	34

About trademarks

“WALKMAN” is a registered trademark of Sony Corporation to represent Headphone Stereo products.  is a trademark of Sony Corporation.

SonicStage is a trademark of Sony Corporation.

ATRAC, ATRAC3, ATRAC3plus and ATRAC Advanced Lossless are trademarks of Sony Corporation.

Create Your Own ATRAC CDs

In addition to the regular music CDs, you can play original CDs (“ATRAC” CDs) that you created with the SonicStage software. Using SonicStage, about 30 audio CDs* can be recorded on one CD-R or CD-RW. SonicStage can be downloaded free of charge.

The following is a quick overview of how you listen to music on your ATRAC CD.

Install SonicStage on your computer.

SonicStage is a software product that takes music from audio CDs or downloaded from the Internet onto your computer to create your own original CDs. SonicStage can be downloaded from the specified site (☞ page 33) and installed on your computer.

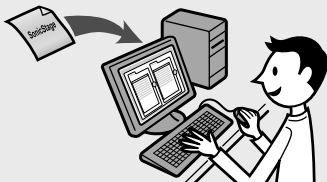

Create an ATRAC CD.

After selecting your favorite songs from music stored on your computer, record them on a CD-R/CD-RW using SonicStage.

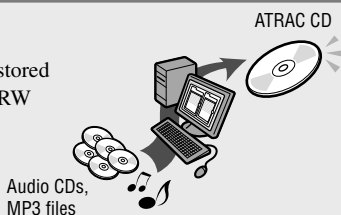

Listen to them with this CD player.

You can take lots of songs wherever you go on your original CD.



- The appropriate system environment to access the Internet is required. For details, refer to the instruction manual of your computer.
- For how to install SonicStage and how to create an ATRAC CD, visit and get information from the specified site for downloading SonicStage. You can also check the SonicStage help section.

* When the total playing time of one CD (album) is estimated at 60 minutes and you are recording on a 700 MB CD-R/CD-RW at 48 kbps in ATRAC format.

Which discs can you play on this CD player?



Audio CDs:

CD-DA format CDs

CD-DA (Compact Disc Digital Audio) is a recording standard used for Audio CDs.



ATRAC CDs:

CD-R/CD-RW on which audio data compressed in the ATRAC format has been recorded*

ATRAC is the general term used to refer to Sony Corporation audio codec technologies ATRAC3, ATRAC3plus, and ATRAC Advanced Lossless**. ATRAC3 and ATRAC3plus, with their high quality compression ratio, and ATRAC Advanced Lossless**, with its no-data-loss compression, combine to provide a vast array of possibilities.

** This player is not compatible with ATRAC Advanced Lossless.

Bit rates and sampling frequencies this CD player can play are:

	Bit rates	Sampling frequencies
ATRAC3	66/105/132 kbps	44.1 kHz
ATRAC3plus	48/64/256 kbps	44.1 kHz

Information (track name, album name, artist name, etc.) of up to 62-characters can be displayed on this CD player.



MP3 CDs:

CD-R/CD-RW on which audio data compressed in the MP3 format has been recorded*

Bit rates and sampling frequencies this CD player can play are shown below. Variable Bit Rate (VBR) files can also be played.

	Bit rates	Sampling frequencies
MPEG-1 Layer3	32 - 320 kbps	32/44.1/48 kHz
MPEG-2 Layer3	8 - 160 kbps	16/22.05/24 kHz
MPEG-2.5 Layer3	8 - 160 kbps	8/11.025/12 kHz

This CD player conforms to Version 1.0/1.1/2.2/3/2.4 of the ID3 tag format. ID3 tag is a format for adding certain information (track name, album name, artist name, etc.) to MP3 files. Up to 64 characters of ID3 tag information can be displayed on this CD player.



CD-Extra and Mix-Mode CDs:

CD-R/CD-RW on which CD-DA format data and CD-ROM format data are recorded together.*

If you cannot play your CD, change the “CD-EXTRA” setting (Ⓢ page 28). Then you may play your CD.

An ATRAC CD on which audio data compressed in the MP3 format has been recorded using software other than SonicStage can also be played.

With SonicStage, you cannot create a CD on which mixed format audio data is recorded.

* Only ISO 9660 Level 1/2 and Joliet extension format discs can be played.

Music discs encoded with copyright protection technologies

This product is designed to play back discs that conform to the Compact Disc (CD) standard. Recently, various music discs encoded with copyright protection technologies are marketed by some record companies. Please be aware that among those discs, there are some that do not conform to the CD standard and may not be playable by this product.

Note on DualDiscs

A DualDisc is a two sided disc product which mates DVD recorded material on one side with digital audio material on the other side. However, since the audio material side does not conform to the Compact Disc (CD) standard, playback on this product is not guaranteed.

Difference in File structures of ATRAC CDs and MP3 CDs

ATRAC CDs and MP3 CDs consist of “files” and “groups.” A “file” is equivalent to a “track” of an audio CD. A “group” is a bundle of files and is equivalent to an “album.”

For MP3 CDs, this CD player recognizes an MP3 folder as a “group” so that ATRAC CDs and MP3 CDs can be operated in the same way.

The usable number of groups and files

- Maximum number of groups: 256
- Maximum number of files: 999

Playing order of ATRAC CDs and MP3 CDs

For ATRAC CDs, files are played in the order selected in SonicStage.

For MP3 CDs, the playing order may differ depending on the method used to record MP3 files on the disc. A “play list” which contains an MP3 file playing order can also be played. In the following example, files are played in order of ① to ⑦.

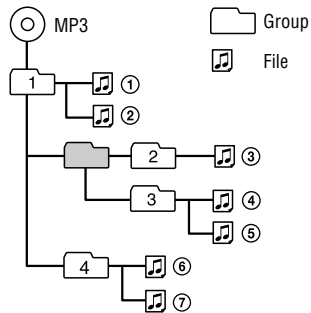

(Maximum directory levels: 8)

Notes

- If **ATRAC** files and MP3 files are recorded on the same CD, this CD player plays the **ATRAC** files first.
- The playback capability of this CD player may vary depending on the quality of the disc and the condition of the recording device.
- Acceptable characters are A to Z, a to z, 0 to 9, and _ (underscore).
- On a disc that has **ATRAC/MP3** files, do not save files in other formats and do not make unnecessary folders.

About ATRAC CDs

- CD-Rs/CD-RWs recorded in the **ATRAC** format cannot be played on your computer.

About MP3 CDs

- Be sure to add the file extension “mp3” to the file name. However, if you add the extension “mp3” to a file other than an MP3 file, the player will not be able to recognize the file properly.
- To compress a source in an MP3 file, we recommend setting the compression parameters to “44.1 kHz,” “128 kbps,” and “Constant Bit Rate.”
- To record up to the maximum capacity, set the writing software to “halting of writing.”
- To record up to the maximum capacity at one time on media that has nothing recorded on it, set the writing software to “Disc at Once.”

Precautions

On safety

- Should any solid objects or liquid fall into the CD player, unplug it and have it checked by qualified personnel before operating it any further.
- Do not put any foreign objects in the DC IN 3 V (external power input) jack.

On the CD player

- Keep the lens on the CD player clean and do not touch it. If you do so, the lens may be damaged and the CD player will not operate properly.
- Do not put any heavy object on top of the CD player. The CD player and the CD may be damaged.
- Do not leave the CD player in a location near heat sources, or in a place subject to direct sunlight, excessive dust or sand, moisture, rain, mechanical shock, unlevelled surface, or in a car with its windows closed.
- If the CD player causes interference to the radio or television reception, turn off the CD player or move it away from the radio or television.
- Discs with non-standard shapes (e.g., heart, square, star) cannot be played on this CD player. Attempting to do so may damage the CD player. Do not use such discs.

On handling CDs

- To keep the CD clean, handle it by its edge. Do not touch the surface.
- Do not stick paper or tape onto the CD.
- Do not expose the CD to direct sunlight or heat sources such as hot air ducts. Do not leave the CD in a car parked under direct sunlight.

On headphones/earphones

Road safety

Do not use headphones/earphones while driving, cycling, or operating any motorized vehicle. It may create a traffic hazard and is illegal in some areas. It can also be potentially dangerous to play your headsets at high volume while walking, especially at pedestrian crossings. You should exercise extreme caution or discontinue use in potentially hazardous situations.

Preventing hearing damage

Avoid using headphones/earphones at high volume. Hearing experts advise against continuous, loud and extended play. If you experience a ringing in your ears, reduce volume or discontinue use.

Consideration for others

Keep the volume at a moderate level. This will allow you to hear outside sounds and to be considerate to the people around you.

Checking the Supplied Accessories

- AC power adaptor (1) • Earphones (1)
(AC-ES3010K2)
(not supplied with USA model)

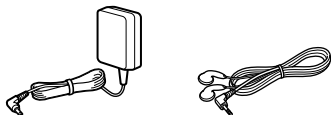

- Rotary commander (1) • Car battery cord (1)



- Car connecting pack (1)

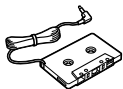

- Velcro tapes for the CD player (2)
- Velcro tape for the rotary commander (1)
- Operating instructions (1)
- AC plug adaptor (1) (for E33 model only*)

* For the area code of the model you purchased, check the upper left side of the bar code on the package.

Note

The supplied rotary commander should be used with this player only.

Guide to Parts and Controls

CD player

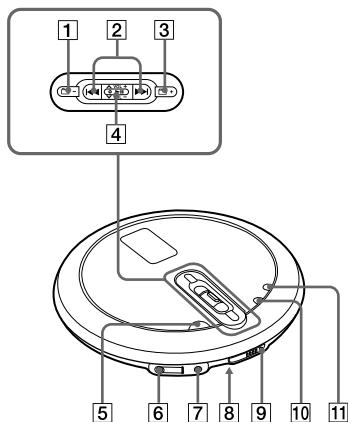

Rotary commander

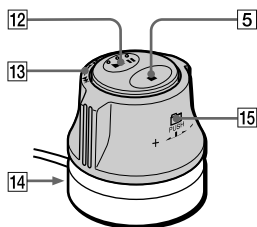

Display

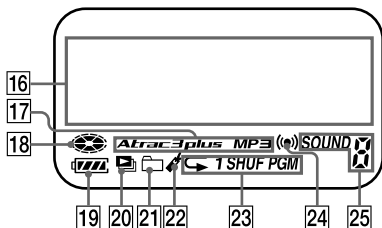

- 1 (group) – button (☞ page 16-18, 23)
- 2 buttons (☞ page 16, 18, 22, 24)
- 3 (group) + button (☞ page 16, 17, 23)
- 4 Jog lever
VOL (volume) +/- (☞ page 15)
^/v (☞ page 17, 18, 20, 22-24, 26)
▶|| (play/pause)* (☞ page 15-18, 20, 22-24, 26)
- 5 CD player:
 - STOP button (☞ page 16-18, 24, 25, 27)
 - Rotary commander:
 - (stop) button (☞ page 16)
- 6 (headphones) jack (☞ page 15)
- 7 DC IN 3 V jack (☞ page 14)
- 8 HOLD switch (on the back of the CD player) (☞ page 17)
- 9 OPEN switch (☞ page 13, 15)
- 10 SEARCH button (☞ page 17, 18)
- 11 DISPLAY/MENU button (☞ page 19, 20, 22, 24, 26)
- 12 ▶|| (play/pause) button (☞ page 16)
- 13 control (☞ page 16)
- 14 Jack for connecting a car connecting pack (☞ page 10)
- 15 (group) +/- control (☞ page 16)
Push down and turn.
- 16 Character information display (☞ page 19)
- 17 Atrac3plus/MP3 indicator (☞ page 5)
- 18 Disc indicator (☞ page 15)
- 19 Battery indicator (☞ page 13)
- 20 Play list indicator
- 21 Group indicator
- 22 Bookmark indicator (☞ page 22)
- 23 Play mode indicator
- 24 Timer indicator (☞ page 27)
- 25 Sound indicator

* This button has a tactile dot.

Installing in a Car

1 Connect your CD player as shown below.

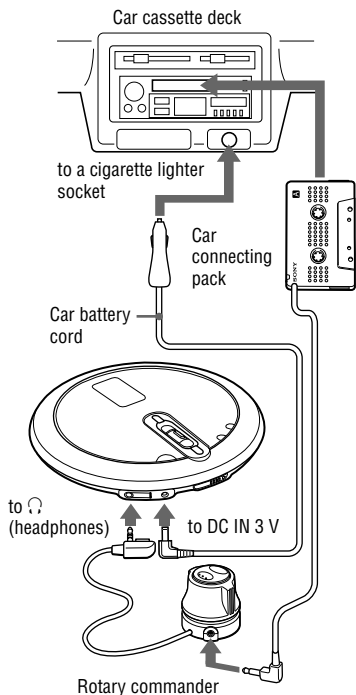

Note

Turn down the volume of the car cassette deck before inserting the car connecting pack.

Where to place your CD player

- Install the CD player in a location which:
 - does not interfere with your driving.
 - is not dangerous for passengers.
 - does not interfere with the glove box lid or ashtray.
 - is stable, and where nothing around it may interfere with installation.
- Do not install the CD player near heat sources or where subject to direct sunlight, excessive dust, or moisture (especially on a dashboard).

Please understand that we will not incur any obligations for troubles caused by incorrect installation.

If you have any questions or problems concerning your CD player, please contact your nearest Sony dealer.

Mounting your CD player

Attach the CD player to the console box with the supplied Velcro tapes.

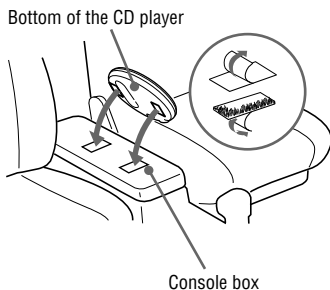

Notes

- Do not affix Velcro tapes to the name plate or any control.
- When you are going to park your car for a long period of time, remove the CD player from the console box and place it where it will not be exposed to direct sunlight.

Note on the car battery cord

The 3 V DC plug supplied with car battery cord conforms to the proposed standards of the Japan Electronics and Information Technology Industries Association (JEITA). Do not connect it to other players.

Polarity of the plug
(JEITA standards)



Replacing the fuse of the car battery cord

If the CD player does not operate, check the fuse. If it is blown, replace it as follows:

- 1 Turn off the CD player and remove the cigarette lighter plug from the cigarette lighter socket.**

- 2 Remove the plug end by turning it counterclockwise.**

- 3 Remove the defective fuse from the plug.**

- 4 Insert a new fuse into the plug.**

- 5 Replace the plug end by turning it clockwise.**

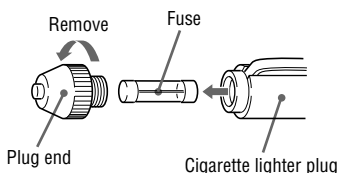

Notes

- Be sure to use a fuse of the same amperage and length as the one to be replaced. Never use a piece of wire as a substitute for the fuse.
- If the fuse is blown again after replacing it, contact your nearest Sony dealer. In such a case, bring the defective fuse to the dealer with you.

Notes on the car connecting pack

- If no sound is heard or the car connecting pack is ejected, change the direction of playback on the car cassette deck.
- Never insert the cord end of the car connecting pack into the cassette insertion door. Otherwise, the cord may break or the car cassette deck may be damaged.
- You cannot use the car connecting pack with some car cassette deck.
- The cord should be placed so that it does not hinder driving.
- To disconnect the cord from the CD player, pull it out by grasping the plug. Never pull the plug out by the cord.
- With some car cassette decks, you may hear some rattling noise from the car connecting pack. However, this is not a sign of malfunction.

Continued ➞

Mounting the rotary commander

If you use the supplied rotary commander, you can control your CD player as easily as you would control the headlight or the wiper switch of your car while driving.

Attach the rotary commander to a flat place as illustrated below.

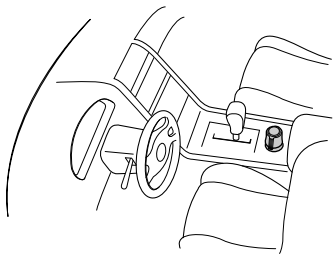

- 2 Secure the rotary commander to the flat place by pressing the Velcro tapes firmly together.

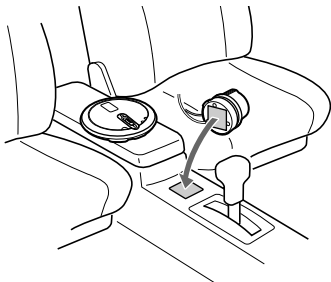

- 1 Attach the supplied Velcro tapes to the bottom of the rotary commander and to a flat place.

Bottom of the rotary commander

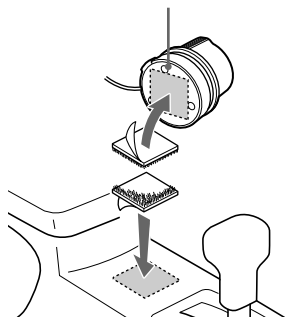

Preparing a Power Source (Dry Battery)

Be sure to remove the AC power adaptor when using the dry battery. Replace the battery with new one when the battery is depleted.

- LR6 (size AA) alkaline battery

- 1 Slide the **OPEN** switch to open the lid of your player.

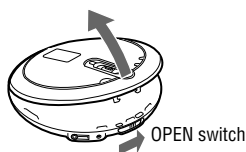

- 2 Open the **battery compartment lid** inside the player.

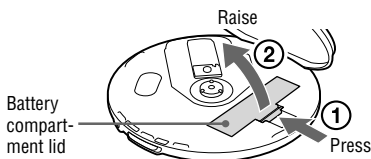

- 3 Insert the LR6 (size AA) battery (not supplied) by matching the **+** end of the battery to the **+** diagram in the battery compartment and close the lids of the battery compartment and the player until they click into place.

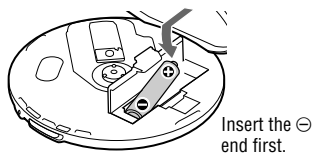

To remove the battery

Remove the battery as illustrated below.

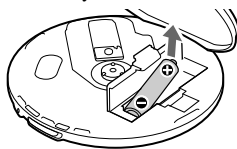

Checking the remaining power of the battery

The remaining power of the battery is indicated in the display as shown below. As the black indicator section decreases, the remaining power is depleted further.

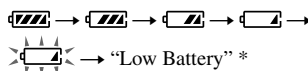

* Beep sounds.

When the battery is depleted, replace it with a new one.

Notes

- The display shows the approximate battery power remaining. For example, one section does not always indicate one-fourth of the battery power.
- Depending on the operating conditions, the display may increase or decrease relative to the actual power remaining.

Continued 

Battery life ¹⁾

When using a Sony alkaline battery LR6 (SG) (produced in Japan)

	G-PROTECTION	
	"1"	"2"
Audio CD	22	20
ATRAC CD ²⁾	41	41
MP3 CD ³⁾	31	31

- 1) Measured value using the JEITA (Japan Electronics and Information Technology Industries Association) Playing time shown is approximate hours, when you use the player on a flat and stable surface and "POWER SAVE" is set to "ON" (Ⓞ page 28). This value varies depending on how the player is used.
- 2) Recorded at 48 kbps
- 3) Recorded at 128 kbps

Notes on dry batteries

- Do not throw the batteries into a fire.
- Do not carry batteries in a pocket, etc. with coins or other metallic objects. The battery can generate heat if its positive and negative terminals are accidentally allowed to come into contact with a metallic object.
- Do not mix new batteries with old ones.
- Do not use different types of batteries together.
- When the batteries are not to be used for a long time, remove them.
- If battery leakage occurs, wipe off any deposit left in the battery compartment, and install new batteries. If the deposit adheres to your skin, wash it off thoroughly.

When using the AC power adaptor

You can use the player powered by the AC power adaptor without the battery.

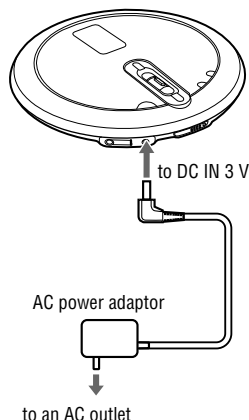

- 1 Connect the AC power adaptor to the DC IN 3 V jack of your CD player and an AC outlet.

Notes on the AC power adaptor

- Disconnect all power sources when the player is not to be used for a long time.
- Use only the AC power adaptor supplied. If your player is not supplied with an AC power adaptor, use an AC-E30HG AC power adaptor*. Do not use any other AC power adaptor. It may cause a malfunction.

*Not available in Australia and some other regions. Ask your dealer for detailed information.

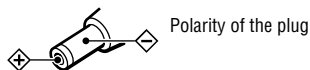

- Do not touch the AC power adaptor with wet hands.
- Connect the AC power adaptor to an easily accessible AC outlet. Should you notice an abnormality in the AC power adaptor, disconnect it from the AC outlet immediately.

Playing a CD

1 Slide the OPEN switch to open the player lid.

Connect the headphones/earphones to the player beforehand.

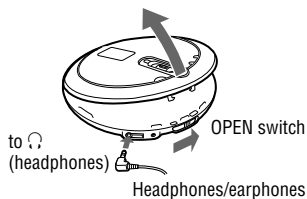

2 Place the CD on the tray and close the lid.

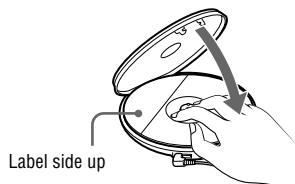

3 Press ►|| on the jog lever.

(disc) moves, and the player starts playback.

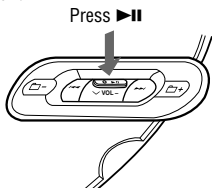

4 Adjust the volume by flicking the jog lever toward VOL + or -.

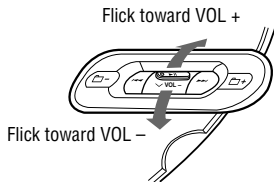

To remove the CD

Remove the CD while pressing the pivot in the center of the tray.



Continued →

Basic playback operations (Play, stop, search)

CD player

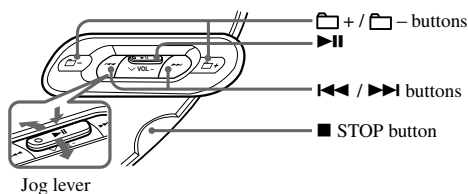

To	Operation on the player (Operation on the rotary commander is in parentheses)	
Play	Play from the first track	From stop, press and hold ►► on the jog lever until playback starts. (From stop, press and hold ►► until playback starts.)
Stop	Pause/Resume play after pausing	Press ►► on the jog lever. (Press ►►.)
	Stop playback	Press ■ STOP. (Press ■ (stop).)
Search	Find the beginning of the current track ¹⁾	Press ◀◀ once. (Turn the control toward ◀◀ once.)
	Find the beginning of previous tracks ¹⁾	Press ◀◀ repeatedly. (Turn the control toward ◀◀ repeatedly.)
	Find the beginning of the next track ¹⁾	Press ▶▶ once. (Turn the control toward ▶▶ once.)
	Find the beginning of succeeding tracks ¹⁾	Press ▶▶ repeatedly. (Turn the control toward ▶▶ repeatedly.)
	Go backwards quickly ¹⁾	Press and hold ◀◀. (Turn and hold the control toward ◀◀.)
	Go forward quickly ¹⁾	Press and hold ▶▶. (Turn and hold the control toward ▶▶.)
	Jump to succeeding groups ²⁾	Press ◻ (group) + repeatedly. (Push down and turn the control toward ◻ (group) + repeatedly.)
	Jump to previous groups ²⁾	Press ◻ (group) - repeatedly. (Push down and turn the control toward ◻ (group) - repeatedly.)

1) You can operate during both play and pause.

2) You can operate during play of a CD other than audio CDs.

Locking the controls (HOLD)

You can prevent accidental button presses while carrying the player by locking the controls.

- 1 Slide the HOLD switch on the back of the player in the direction of the arrow.

“HOLD” flashes if you press any button when the HOLD function is activated.

To unlock the controls

Slide the HOLD switch in the direction opposite to that of arrow.

Searching for Your Favorite Track/File

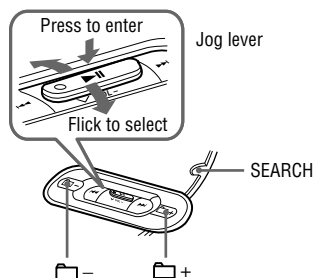

Searching by viewing groups (File View)

On a CD such as an ATRAC CD or an MP3 CD on which a number of files are recorded, you can search for a file by checking the names of groups (except on an audio CD) or files around the file being played.

- 1 Press SEARCH repeatedly.

The names of groups and files around the current file appear on the display.

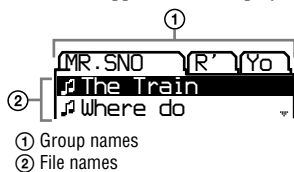

- 2 Press or to select a group.

- 3 Flick the jog lever toward \wedge/\vee to select a file.

- 4 Press on the jog lever.

The file you have selected starts playing.

To cancel searching

Press STOP on the CD player.

Continued

Searching by viewing a list of groups/files (List View)

You can search for a track/file by checking the format type of the music source and the names of groups and files.

1 Press SEARCH repeatedly.



If you play a CD on which mixed audio data has been recorded:

The screen for selecting the format type such as “ATRAC ROOT” and “MP3 ROOT” appears first.

Press **▶II** on the jog lever.

2 Flick the jog lever toward \wedge/\vee to select a group and press **▶II**.

3 Flick the jog lever toward \wedge/\vee to select a file.

4 Press **▶II** on the jog lever.

The file you have selected starts playing.

To return to the previous screen

Press **◀◀** or **□-** on the CD player.

To cancel searching

Press **■ STOP** on the CD player.

Checking CD information on the display

You can check CD information on the display. Depending on the region in which you purchased your CD player, the default language may not be “ENGLISH.” Change the LANGUAGE setting, if necessary (☞ page 27).

When you are playing an MP3 CD containing files with an ID3 tag, ID3 tag information is displayed. (When there is no ID3 tag information, file name or group name is displayed.) (☞ page 5)

Notes

- The characters A-Z, a-z, 0-9, and _ can be displayed on this player.
- Before playing a file, the player reads all file and group (or folder) information on the CD. “Reading” is displayed. Depending on the content of the CD, it may take some time to accomplish this reading.
- If the file does not belong to any group, “MP3 ROOT” appears on the display.

To check information on the display

Press DISPLAY/MENU repeatedly.

Audio CD

Track number, elapsed playing time
(Artist name, track name)¹⁾

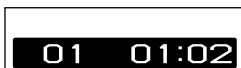

Total number of tracks on the CD, total remaining time of the CD, remaining time of the current track²⁾

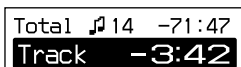

File view screen



ATRAC CD/MP3 CD

File name, artist name³⁾, file number, elapsed playing time



Group name³⁾, CODEC information⁴⁾, total number of files



File view screen

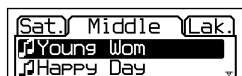

- 1) When you are playing an audio CD containing text information such as CD-TEXT, information in parentheses is displayed.
- 2) The displays appear only during normal play.
- 3) During play, "artist name" is not displayed if the disc does not have ID3 tag information. When the list of group names/file names appears on the display, "artist name" and "group name" are not displayed.
- 4) Bit rate and sampling frequencies are displayed. While an MP3 file made at VBR (variable bit rate) is being played, "VBR" appears on the display instead of a bit rate. In some cases, "VBR" appears halfway through playback, rather than from the beginning.

Changing Playback Options (PLAY MODE)



You can use various playback options such as selecting songs you want to listen to, and playing songs in your favorite order.

For details about playback options, see  page 21.

You can also play songs repeatedly using the playback options you choose (repeat play,  page 23).

- 1 Press **DISPLAY/MENU** until the menu screen appears.



 : PLAY MODE
 : SOUND
 : OPTION

- 2 Flick the jog lever toward \wedge/V to select “ PLAY MODE” and press **▶II**.

- 3 Flick the jog lever toward \wedge/V to select the playback option.

The default setting is “ALL” (normal play).



- 4 Press **▶II** on the jog lever.

- 5 When “REPEAT” appears, select “ON” or “OFF” and press **▶II** on the jog lever.



To return to normal play

Select “ALL” in the PLAY MODE menu.

Playback options (PLAY MODE)

Display on the CD player	Explanation
ALL	All tracks on the CD are played in a track number order. For the ATRAC CD/MP3 CD, a playing order is different according to the setting of the "PLAY ORDER."
GROUP	All files in the selected group or all groups are played (ATRAC CD/MP3 CD only) (☞ page 22).
1	The current track is played once.
SHUFFLE	All tracks on the CD are played once in random order.
GROUP SHUFFLE	All files in the selected group are played once in random order (ATRAC CD/MP3 CD only) (☞ page 22).
BOOKMARK	Tracks to which Bookmarks have been added are played. The play of tracks with Bookmarks starts in track number order, not in the order you added the Bookmarks (☞ page 22).
PLAYLIST	Tracks in the selected m3u play list* are played (MP3 CD only) (☞ page 22).
AUTO RANKING	The tracks you have played most frequently from the CD are played from the 10th to the first.
RANKING SHUF	Up to 32 tracks, which the player has automatically memorized as the most frequently played ones, are played in random order.
PROGRAM	Up to 64 tracks are played in your favorite order (☞ page 23).
INTRO	About the first 10 seconds of all tracks which follow the current track are played once.

*An m3u play list is a file in which an MP3 file playing order has been encoded. To use the play list function, record MP3 files on a CD-R/CD-RW using encoding software that supports the m3u format.
You can play the top 8 lists (listed by file name) on your screen on the CD player.

Continued 

Playing groups

1 Perform steps 1 and 2 of “Changing Playback Options (PLAY MODE)” (Ⓞ page 20). In step 3, select “GROUP” or “GROUP SHUFFLE” and press ►II on the jog lever.

2 Flick the jog lever toward \wedge/V to select a group.

If you select a group on an MP3 CD, etc. by searching through all the directories, press ◀◀ or ▶▶.

If you select a group within the same directory, flick the jog lever toward \wedge/V .

3 Press ►II on the jog lever for 2 seconds or more.

The player starts playback of all files in the group you have selected.

4 When “REPEAT” appears, select “ON” or “OFF” and press ►II on the jog lever.

Note

If the group has no tracks, or the group is located in the lowest directory level, “Invalid” appears on the display.

Playing your favorite tracks (Bookmark play)

1 During play of the track to which you want to add a Bookmark, press ►II on the jog lever until ✎ flashes slowly.

2 If you want to add a Bookmark to two or more tracks, repeat step 1.

You can add Bookmarks to up to 10 CDs for audio CDs (up to 99 tracks for each CD) and up to 5 CDs* for ATRAC CDs/MP3 CDs (up to 999 tracks for each CD).

3 Press DISPLAY/MENU until the menu screen appears.

4 Flick the jog lever toward \wedge/V to select “PLAY MODE,” and press ►II.

5 Flick the jog lever toward \wedge/V to select “BOOKMARK,” and then press ►II.

6 When “REPEAT” appears, select “ON” or “OFF” and press ►II.

To remove Bookmarks

During play of a track with a Bookmark, press and hold ►II on the jog lever until ✎ disappears.

Notes

- If you try to add Bookmarks to tracks on an 11th CD (on a 6th CD* when playing ATRAC CDs/MP3 CDs), the Bookmarks of the CD you played first will be erased.
 - All Bookmarks stored in memory will be erased if you remove all power sources.
 - * When each CD has 513 tracks or more.
-

Playing your favorite play lists (m3u play list play)

1 In step 3 of “Changing Playback Options (PLAY MODE)” (Ⓞ page 20), select “PLAYLIST.”

2 Flick the jog lever toward \wedge/V to select a play list.

3 Press ►II on the jog lever.

Playing tracks in your favorite order (PGM play)

- 1 While the player is stopped, select “PROGRAM” in step 3 of “Changing Playback Options (PLAY MODE)” (☞ page 20), and then press ►II on the jog lever.



- 2 Flick the jog lever toward ^/V to select a track, and press and hold ►II until display changes.

When playing an ATRAC CD/MP3 CD:
You can also select a file in another group by pressing + or -.

- 3 Repeat step 2 to select tracks in your favorite order.

You can select up to 64 tracks.

When you finish entering the 64th track, the track number selected first (audio CD)/file name (ATRAC CD/MP3 CD) appears on the display.

If you select 65 tracks or more, the tracks selected first are erased one by one.

- 4 Press ►II on the jog lever.

Playback starts in the selected order.

To check the program

- 1 While the player is stopped, select “PROGRAM” in step 3 of “Changing Playback Options (PLAY MODE)” (☞ page 20), and then press and hold ►II on the jog lever until the display changes.
- 2 On the player, whenever you press and hold ►II, the tracks are displayed in playing order.

Playing tracks repeatedly (Repeat play)

- 1 Select “ON” in step 5 of “Changing Playback Options (PLAY MODE)” (☞ page 20).

The playback option you have selected repeats.

To return to normal play

Select “OFF.”

Changing Sound Quality

For details about the setting of SOUND items, see  page 25.

Selecting the sound quality

You can set up the “EQUALIZER” setting and/or “CLEARBASS” setting. If you set both at the same time, you can enjoy more bass sound along with the sound quality you want.

-
- 1 Press **DISPLAY/MENU** until the menu screen appears.
 - 2 Flick the jog lever toward \wedge/\vee to select “**SOUND**” and press **▶II**.



-
- 3 Flick the jog lever toward \wedge/\vee to select the item you want to set up and press **▶II**.
 - 4 Flick the jog lever toward \wedge/\vee to select an option and press **▶II**.

Customizing sound quality

You can adjust sound quality for each frequency range individually, checking the shape of the wave on the display.

-
- 1 Select “EQUALIZER” in step 3 and “CUSTOM” in step 4 of “Selecting the sound quality.”

-
- 2 Press **◀◀** or **▶▶** for 2 seconds or more to select the frequency range.



“Low” is displayed first. There are 3 frequency ranges; “Low” (low range audio), “Mid” (middle range audio), and “High” (high range audio).

-
- 3 Press **◀◀** or **▶▶** repeatedly to select the shape of the wave. There are 3 shapes stored in memory for each frequency range.



Frequency range

-
- 4 Flick the jog lever toward \wedge/\vee to select the sound volume.

The sound volume can be adjusted in 7 levels.

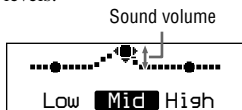

-
- 5 Repeat steps 2 to 4 to make adjustments for the remaining 2 frequency ranges, and then press **▶II** on the jog lever.

To return to the previous screen

Press **■ STOP** on the CD player.

To cancel the adjustment operation

Press **■ STOP** on the CD player for 2 seconds or more.

Notes

- If the sound is distorted by your sound settings when you turn up the volume, turn the volume down.
- If you feel a difference in sound volume between the “CUSTOM” sound setting and other sound settings, adjust the volume to your preference.

SOUND items

To return to the previous screen, press **■ STOP** on the CD player. To cancel the setting operation, press **■ STOP** on the CD player for 2 seconds or more.

Item	Options (●: Default setting)	
EQUALIZER (Equalizer setting)	● OFF	Normal sound quality
	SOFT	For vocal, stressing middle range audio
	ACTIVE	Lively sounds, emphasizing high and low range audio
	HEAVY	Powerful sounds, further emphasizing high and low ranges compared with ACTIVE sound
	CUSTOM	Customized sound (see  page 24 for details)
CLEARBASS (Bass sound setting)	● OFF	Normal sound quality.
	1	Emphasizing bass sound.
	2	Emphasizing bass sound more than 1.
	3	Emphasizing bass sound more than 2.

Note

If you change the setting of the EQUALIZER item after you have set the CLEARBASS item, the setting of the EQUALIZER item gets priority.

When you set both the EQUALIZER item and the CLEARBASS item, set the EQUALIZER item first.

Changing Optional Settings

For details about the setting of OPTION items, see  page 27.

Setting various functions

You can set the various functions such as the language for the menu and the playback order of the groups/files.

-
- 1 Press DISPLAY/MENU until the menu screen appears.**
 - 2 Flick the jog lever toward \wedge/\vee to select “ OPTION” and press \blacktriangleright II.**



-
- 3 Flick the jog lever toward \wedge/\vee to select the item you want to set up and press \blacktriangleright II.**
 - 4 Flick the jog lever toward \wedge/\vee to select an option and press \blacktriangleright II.**

When you are setting the “LANGUAGE” or “PLAY ORDER,” repeat step 4.

OPTION items

To return to the previous screen, press **■ STOP** on the CD player. To cancel the setting operation, press **■ STOP** on the CD player for 2 seconds or more.

Items	Options (●: Default settings)	
LANGUAGE (Language for menu, etc.)	MENU	<ul style="list-style-type: none"> ● ENGLISH Select the language for menu text, warning message, etc. FRANÇAIS DEUTSCH ITALIANO PORTUGUÊS РУССКИЙ ESPAÑOL
	TEXT ¹⁾²⁾	<ul style="list-style-type: none"> ● AUTO ³⁾ Select the language for CD-TEXT, ID3 tag, etc. ENGLISH FRANÇAIS DEUTSCH ITALIANO PORTUGUÊS РУССКИЙ ESPAÑOL
G-PROTECTION ¹⁾ (To prevent sound skipping)	● 1	Protection against sound skipping is provided with high quality CD sound.
	2	Enhanced protection against sound skipping is provided.
AVLS ⁴⁾ (Limiting volume)	● OFF	The volume changes without limiting the volume level.
	ON	The maximum volume is limited to protect your hearing.
TIMER (Off timer)	● OFF	The timer does not work.
	ON	1-99 min (●) is displayed on the player. You can check the remaining playback time by selecting this option during play. Flick the jog lever toward \wedge/\vee repeatedly to increase or decrease the length of time by 5 minutes, or keep flicking the jog lever toward \wedge/\vee to increase or decrease by 1 minute. The default setting is "10 min."
BEEP (Sound of operation)	● ON	The beep sounds when you operate the player.
	OFF	The beep is turned off.

Continued 

Items	Options (●: Default settings)		
SEAMLESS ¹⁾⁵⁾ (Playing tracks continuously)	● OFF	The CD is played as recorded on the disc, including spaces between tracks.	
	ON	The CD is played without space between tracks.	
POWER SAVE ¹⁾ (Saving power)	● OFF	The POWER SAVE function does not work.	
	ON	Setting of the SOUND items is not effective.	
PLAY ORDER ¹⁾⁶⁾ (Playback order)	TRACK	● NORMAL	Play back the music source in the order of recording.
		ID3TAG TNO	Play back in the order of ID3 tag number.
		FILE NAME	Play back in the alphabetical order of the file names.
	GROUP	● OFF	Play back the music source in the order of recording.
		ON	Play back the music source in the order of group names.
CD-EXTRA ¹⁾⁷⁾ (Playback by disc format)	● OFF	Set to "OFF" as long as you can play your CD normally.	
	ON	If you cannot play your CD-Extra, set to "ON." You may play it.	

- 1) You can set this up only while the player is stopped.
- 2) The TEXT option cannot be set for Audio CDs. For CD-Extra CDs, you can select the TEXT option when "CD-EXTRA" is set to "ON."
- 3) The item "AUTO" is displayed in the same language that you selected for the "LANGUAGE" - "MENU" options.
- 4) AVLS is an abbreviation of the Automatic Volume Limiter System.
- 5) This function works only for ATRAC CDs.
- 6) This function does not work for Audio CDs.
- 7) This function works only for Audio CDs and CD-Extra CDs.

Notes

- Even if "G-PROTECTION" is set to "2," sound may skip:
 - when the CD player receives stronger continuous shock than expected,
 - when a dirty or scratched CD is played, or
 - for CD-Rs/CD-RWs, when a poor-quality disc is played or there is a problem with the original recording device or application software.
- Even if "SEAMLESS" is set to "ON," the tracks may not play continuously depending on how the source music was recorded.

Troubleshooting

Should any problem persist after you have checked these symptoms, consult your nearest Sony dealer.



Sound

Symptom	Cause and/or corrective action
The volume does not increase even if you flick the jog lever toward VOL + repeatedly.	→ "AVLS" is set to "ON." Set it to "OFF" (☞ page 27).
No sound, or noise is heard.	→ Connect the headphones/earphones plugs firmly. → The plugs are dirty. Clean the headphones/earphones plugs with a dry soft cloth periodically.
A rustling noise is heard from the CD.	→ Close the lid of the battery compartment firmly (☞ page 13).
SOUND items cannot be set up.	→ "POWER SAVE" is set to "ON." Set it to "OFF" (☞ page 28).

Operation/Playback

Symptom	Cause and/or corrective action
The playing time is too short. The CD does not play.	→ Check that you are using an alkaline battery and not a manganese battery. → Replace the dry battery with a new LR6 (size AA) alkaline battery (☞ page 13).
Certain tracks cannot be played.	→ You tried to play files saved in a format that is not compatible with this player (☞ page 5). → Change the setting of "CD-EXTRA." You may play your CD (☞ page 28).
"Low Battery" appears on the display, and the CD does not play.	→ Replace the dry battery with a new LR6 (size AA) alkaline battery (☞ page 13).
"Hi DC in" appears on the display.	→ An AC power adaptor which is rated higher than the one supplied or recommended is being used. Use only the supplied AC power adaptor or the car battery cord recommended in "Optional Accessories" (☞ page 33).

Continued ⇐

Symptom	Cause and/or corrective action
The CD does not play, or “No Disc” appears on the display when a CD is placed in the player.	<ul style="list-style-type: none"> → The CD is dirty or defective. Clean it or change it. → Check that the CD is inserted with the label side up (☞ page 15). → Moisture condensation* has occurred. Leave the CD player aside for several hours until the moisture evaporates. <ul style="list-style-type: none"> * Moisture is likely to condense on the lense inside the CD player when you bring the player from the cold outdoors into the warm indoors. → Close the lid of the battery compartment firmly (☞ page 13). → Make sure the battery is inserted correctly (☞ page 13). → Connect the AC power adaptor to an AC outlet securely (☞ page 14). → Press ► after one second or more has passed since the AC power adaptor was connected. → The CD-R/CD-RW in the player is blank. → There is a problem with the quality of the CD-R/CD-RW, recording device, or application software.
“HOLD” flashes on the display when you press a button, and the CD does not play.	<ul style="list-style-type: none"> → The buttons are locked. Slide the HOLD switch back (☞ page 17).
Playback starts from the point you stopped (resume function).	<ul style="list-style-type: none"> → The resume function is working. To start play from the first track, press and hold ► while the player is stopped until the first track starts playing, or open the lid of the player (☞ page 16). Or, remove all power sources, and then insert the battery or connect the AC power adaptor again.
During playback of an ATRAC CD or MP3 CD, the CD does not rotate but you can hear the sound normally.	<ul style="list-style-type: none"> → This player is designed to stop the rotation of an ATRAC CD or MP3 CD during playback to reduce the power consumption. The player is not malfunctioning.
“No File” appears on the display after you press ► or when the lid of the player is closed.	<ul style="list-style-type: none"> → There are no ATRAC/MP3 files on the CD-R/CD-RW. → A CD-R/CD-RW from which the data has been erased is being used. → The CD is dirty.
The LCD display becomes hard to see or slows down.	<ul style="list-style-type: none"> → You are using your CD player at high temperatures (above 40°C/104°F) or at low temperatures (below 0°C/32°F). At room temperature, the display will return to its normal operating condition.
Even though you have not selected “BOOKMARK,”  (Bookmark) flashes.	<ul style="list-style-type: none"> → If you have selected a playback option other than “BOOKMARK,”  (Bookmark) flashes.

Symptom	Cause and/or corrective action
Play stopped abruptly.	<ul style="list-style-type: none"> → The off timer has been set. Change the setting of "TIMER" to "OFF" (☞ page 27). → The dry battery is used up completely. Replace the dry battery with a new LR6 (size AA) alkaline battery (☞ page 13).

Others

Symptom	Cause and/or corrective action
When closing the lid of the CD player, the CD starts to rotate.	→ The player is reading the information on the CD, not malfunctioning.

Maintenance

To clean the casing

Use a soft cloth slightly moistened in water or a mild detergent solution. Do not use alcohol, benzine or thinner.

Specifications

System

Compact disc digital audio system

Laser diode properties

Emission duration: Continuous

Laser output: Less than 44.6 μ W

(This output is the value measured at a distance of 200 mm from the objective lens surface on the optical pick-up block with 7 mm aperture.)

D-A conversion

1-bit quartz time-axis control

Frequency response

20 - 20 000 Hz ± 1 dB (measured by JEITA)

Output

Headphones (stereo minijack)

Approx. 15 mW + Approx. 15 mW at 16 Ω

Power requirements

- LR6 (size AA) battery: 1.5 V DC \times 1
- AC power adaptor (DC IN 3 V jack):
220 V, 50 Hz (Model for China)
120 V, 60 Hz (Model for Mexico)

Operating temperature

5°C - 35°C (41°F - 95°F)

Dimensions (w/h/d) (excluding projecting parts and controls)

Approx. 137.8 \times 31.1 \times 137.8 mm
(5 $\frac{1}{2}$ \times 1 $\frac{1}{4}$ \times 5 $\frac{1}{2}$ in.)

Mass (excluding accessories)

Approx. 191 g (6.8 oz.)

US and foreign patents licensed from Dolby Laboratories.

MPEG Layer-3 audio coding technology and patents licensed from Fraunhofer IIS and Thomson.

Design and specifications are subject to change without notice.

Optional Accessories

AC power adaptor	AC-E30HG *
Active speaker system	SRS-Z30/Z31 SRS-Z510
Car battery cord	DCC-E345
Car battery cord with car connecting pack	DCC-E34CP
Car connecting pack	CPA-9C
Connecting cord	RK-G129 RK-G136
Earphones	MDR-EX51LP MDR-EX71SL MDR-G74SL

* Specifications for AC power adaptors vary for each area. Check your local voltage and the shape of the plug before purchasing.

Your dealer may not handle some of the accessories listed above. Please ask the dealer for detailed information about the accessories in your country/region.

SonicStage Download Website

You can install SonicStage by the following;

- 1 Select from below your region website.
 - 2 Access the SonicStage free download website and download following the instructions provided.
(Before downloading please read carefully the information provided on the site.)
 - 3 Download the file, and execute according to the instructions.
- For customers in Asia, the Middle East, Africa and Oceania:
<http://www.css.ap.sony.com>
(TOP page → Downloads → Personal Audio → SonicStage)
 - For customers in Latin:
<http://www.sony-latin.com/soporte/>
 - For customers in US:
<http://www.sony.com/walkmansupport>

Index

Symbols

 (Battery) 13

 (disc) 15

1 21

 (Timer) 27

A

ACTIVE 25

AC power adaptor 8

ALL 21

ATRAC 5

ATRAC3plus 5

ATRAC CD 5

AUTO RANKING 21

AVLS 27

B

Battery compartment lid 13

Battery life 14

BEEP 27

BOOKMARK 21, 22

C

Car battery cord 8, 10

Car cassette deck 10

Car connecting pack 8, 10

CD-DA format 5

CD-Extra 5

CD-EXTRA 28

CD-TEXT 19

CD player 9

CLEARBASS 24, 25

CUSTOM 25

D

Display 9

Dry battery 13

E

Earphones 8

EQUALIZER 24, 25

F

File View 17

Fuse of the car battery cord 11

G

G-PROTECTION 27

GROUP 21, 22, 28

Group 6

GROUP SHUFFLE 21, 22

H

HEAVY 25

HOLD function 17

I

ID3 tag 18

INTRO 21

L

LANGUAGE 27

List View 18

M

m3u play list play 22

MENU 27

Mix-Mode CD 5

MP3 CD 5

O

OPTION 27

Optional Accessories 33

P

Pause 16

Play 16

PLAYLIST 21

PLAY MODE 20

PLAY ORDER 28

POWER SAVE 28

PROGRAM 21, 23

R

RANKING SHUF 21

Repeat play 23

Rotary commander 8, 10, 12

S

SEAMLESS 28

Search 16

SHUFFLE 21

SOFT 25

SonicStage 4

SOUND 25

Stop 16

T

TEXT 27

TIMER 27

TRACK 28

This warranty is valid only in the United States.

SONY®

Portable Memory Stick Audio Player/
Portable MiniDisc Recorder/
Portable CD Player/
Portable IC Audio Player/
Portable Hard Disk Audio Player

Portable Audio

LIMITED WARRANTY

Sony Electronics Inc. ("Sony") warrants this Product (including any accessories) against defects in material or workmanship as follows:

1. **LABOR:** For a period of 90 days from the date of purchase, if this Product is determined to be defective, Sony will repair or replace the Product, at its option, at no charge, or pay the labor charges to any Sony authorized service facility. After the Warranty Period, you must pay for all labor charges.

2. **PARTS:** In addition, Sony will supply, at no charge, new or rebuilt replacements in exchange for defective parts for a period of one (1) year. After 90 days from the date of purchase, labor for removal and installation is available from Sony authorized service facilities or a Sony Service Center at your expense.

To obtain warranty service, you must take the Product, or deliver the Product freight prepaid, in either its original packaging or packaging affording an equal degree of protection, to any authorized Sony service facility.

This warranty does not cover customer instruction, installation, set up adjustments or signal reception problems.

This warranty does not cover cosmetic damage or damage due to acts of God, accident, misuse, abuse, negligence, commercial use, or modification of, or to any part of the Product, including the antenna. This warranty does not cover damage due to improper operation or maintenance, connection to improper voltage supply, or attempted repair by anyone other than a facility authorized by Sony to service the Product. This warranty does not cover Products sold AS IS or WITH ALL FAULTS, or consumables (such as fuses or batteries). This warranty is valid only in the United States.

Proof of purchase in the form of a bill of sale or receipted invoice which is evidence that the unit is within the Warranty period must be presented to obtain warranty service.

This warranty is invalid if the factory applied serial number has been altered or removed from the Product.

REPAIR OR REPLACEMENT AS PROVIDED UNDER THIS WARRANTY IS THE EXCLUSIVE REMEDY OF THE CONSUMER. SONY SHALL NOT BE LIABLE FOR ANY INCIDENTAL OR CONSEQUENTIAL DAMAGES FOR BREACH OF ANY EXPRESS OR IMPLIED WARRANTY ON THIS PRODUCT. EXCEPT TO THE EXTENT PROHIBITED BY APPLICABLE LAW, ANY IMPLIED WARRANTY OF MERCHANTABILITY OR FITNESS FOR A PARTICULAR PURPOSE ON THIS PRODUCT IS LIMITED IN DURATION TO THE DURATION OF THIS WARRANTY.

Some states do not allow the exclusion or limitation of incidental or consequential damages, or allow limitations on how long an implied warranty lasts, so the above limitations or exclusions may not apply to you. In addition, if you enter into a service contract with the Sony Partnership within 90 days of the date of sale, the limitation on how long an implied warranty lasts does not apply to you. This warranty gives you specific legal rights, and you may have other rights which vary from state to state.

For your convenience, Sony Electronics Inc. has established telephone numbers for frequently asked questions:

To locate the servicer or dealer nearest you, or for service assistance or resolution of a service problem, or for product information or operation, contact:

www.sony.com/walkmansupport

Sony Network Portable Audio Support Line
1-866-456-7669

For an accessory or part not available from your authorized dealer, call:

1-800-488-SONY (7669)

D 324343304



Printed on 100 % recycled paper.

<http://www.sony.net/>

Sony Corporation Printed in Malaysia



* 2 6 6 3 9 5 7 1 1 *

(1)