

# PRIMUS<sup>®</sup> 660

## Digital Weather Radar System

### *Pilot's Manual*

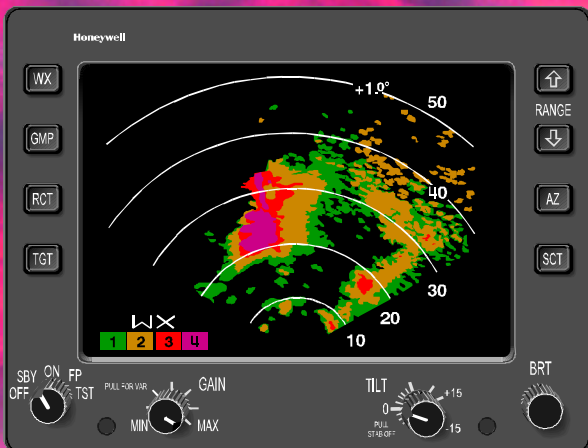

Honeywell  
Aerospace Electronic Systems  
CES-Phoenix  
P.O. Box 21111  
Phoenix, Arizona 85036-1111  
U.S.A.

TO: HOLDERS OF THE PRIMUS® 660 DIGITAL WEATHER  
RADAR SYSTEM PILOT'S MANUAL, HONEYWELL PUB.  
NO. A28-1146-111

REVISION NO. 3 DATED AUGUST 2003

HIGHLIGHTS

Pages that have been revised are outlined below. Remove and insert the affected pages listed. The revision number has been added to the bottom of the revised pages and revision bars have been used to indicate the revised or added text. Insert this highlights letter in the manual in your possession ahead of page RR-1/RR-2, Record of Revisions. The List of Effective Pages shows the order in which to insert the attached new pages of front material into your manual.

<b>Page No.</b>	<b>Description of Change</b>
Title Page	Revised to reflect revision 3. Update Proprietary Notice. Changed S99 to S2003 and changed copyright from 1999 to 2003.
RR-1/RR-1	Revised to reflect revision 3.
LEP-1 thru LEP-3/LEP-4	Revised to reflect revision 3.
6-1/6-2	Removed Inc. in Honeywell in paragraph above figure. Replaced art in Figure 6-1.

# Honeywell

---

Honeywell  
Aerospace Electronic Systems  
CES-Phoenix  
P.O. Box 21111  
Phoenix, Arizona 85036-1111  
U.S.A.

# PRIMUS<sup>®</sup> 660 Digital Weather Radar System

## Pilot's Manual

## PROPRIETARY NOTICE

This document and the information disclosed herein are proprietary data of Honeywell. Neither this document nor the information contained herein shall be used, reproduced, or disclosed to others without the written authorization of Honeywell, except to the extent required for installation or maintenance of recipient's equipment.

NOTICE – FREEDOM OF INFORMATION ACT (5 USC 552) AND DISCLOSURE OF CONFIDENTIAL INFORMATION GENERALLY (18 USC 1905)

This document is being furnished in confidence by Honeywell. The information disclosed herein falls within exemption (b) (4) of 5 USC 552 and the prohibitions of 18 USC 1905.

All rights reserved. No part of this book, CD, or PDF may be reproduced or transmitted in any form or by any means, electronic or mechanical, including photocopying, recording, or by any information storage and retrieval system, without the written permission of Honeywell International, except where a contractual arrangement exists between the customer and Honeywell.

S2003



Member of GAMA



General Aviation  
Manufacturer's Association

*PRIMUS and LASEREF are U.S. registered trademarks of Honeywell*

*DATA NAV is a U.S. trademarks of Honeywell*

## Record of Revisions

Upon receipt of a revision, insert the latest revised pages and dispose of superseded pages. Enter revision number and date, insertion date, and the incorporator's initials on the Record of Revisions. The typed initials H are used when Honeywell is the incorporator.

Revision Number	Revision Date	Insertion Date	By
1	Aug 1999	Aug 1999	HI
2	Dec 1999	Dec 1999	HI
3	Aug 2003	Aug 2003	H

## Record of Temporary Revisions

Upon receipt of a temporary revision, insert the yellow temporary revision pages according to the filing instructions on each page. Then, enter the temporary revision number, issue date, and insertion date on this page.

Temporary Revision No.	Issue Date	Date the Temporary Revision Was Incorporated by a Regular Revision	Insertion of Temporary Revision, Date/By	Removal of Temporary Revision, Date/By

## List of Effective Pages

Original .. 0 .. Feb 1998  
 Revision .. 1 .. Aug 1999  
 Revision .. 2 .. Dec 1999  
 Revision .. 3 .. Aug 2003

<u>Subheading and Page</u>	<u>Revision</u>	<u>Subheading and Page</u>	<u>Revision</u>
Title Page	■ 3	3-4	0
		3-5	0
Record of Revisions		3-6	0
RR-1/RR-2	■ 3	3-7	0
		3-8	0
Record of Temporary Revisions		3-9	0
RTR-1/RTR-2	0	3-10	0
		3-11	0
List of Effective Pages		3-12	0
LEP-1	■ 3	3-13	0
LEP-2	■ 3	3-14	0
LEP-3/LEP-4	■ 3	3-15	0
		3-16	0
Table of Contents		3-17/3-18	0
TC-1	0		
TC-2	1	Normal Operation	
TC-3	1	4-1	0
TC-4	1	4-2	0
TC-5	1	4-3	0
TC-6	1	4-4	0
TC-7/TC-8	1	4-5	0
		4-6	0
Introduction			
1-1	0	Radar Facts	
1-2	0	5-1	0
		5-2	0
System Configurations		5-3	0
2-1	0	5-4	0
2-2	0	5-5	0
2-3	0	5-6	0
2-4	0	5-7	0
2-5/2-6	0	5-8	0
		5-9	0
Operating Controls		5-10	0
3-1	0	5-11	0
3-2	0	5-12	0
3-3	0		

■ indicates changed, added or deleted pages.  
 F indicates right foldout page with a blank back.

<u>Subheading and Page</u>	<u>Revision</u>	<u>Subheading and Page</u>	<u>Revision</u>
Radar Facts (cont)		Maximum Permissible Exposure Level (MPEL)	
5-13	0		
5-14	0	6-1/6-2	■ 3
5-15	0		
5-16	0	In-Flight Adjustments	
5-17	0	7-1	0
5-18	0	7-2	0
5-19	0	7-3	0
5-20	0	7-4	0
5-21	0	7-5	0
5-22	0	7-6	0
5-23	0	7-7	0
5-24	0	7-8	0
5-25	0	7-9	0
5-26	0	7-10	0
5-27	0	7-11	0
5-28	0	7-12	0
5-29	0	7-13	0
5-30	0	7-14	0
5-31	0	7-15/7-16	0
5-32	0		
5-33	0	In-Flight Troubelshooting	
5-34	0	8-1	0
5-35	0	8-2	0
5-36	0	8-3	0
5-37	0	8-4	0
5-38	0	8-5	0
5-39	0	8-6	0
5-40	0	8-7	0
5-41	0	8-8	0
5-42	0		
5-43	0	Honeywell Product Support	
5-44	0	9-1	1
5-45	0	9-2	1
5-46	0	9-3	1
5-47	0	9-4	1
5-48	0		
5-49	0	Abbreviations	
5-50	0	10-1	1
5-51	0	10-2	1
5-52	0	10-3/10-4	1
5-53	0		
5-54	0	Appendix A	
5-55	0	A-1	0
5-56	0	A-2	0
5-57	0	A-3	0
5-58	0	A-4	0
		A-5	0



<u>Subheading and Page</u>	<u>Revision</u>	<u>Subheading and Page</u>	<u>Revision</u>
Appendix A (cont)			
A-6	0		
A-7	0		
A-8	0		
A-9	0		
A-10	0		
A-11	0		
A-12	0		
A-13/A-14	0		
Appendix B			
B-1	1		
B-2	1		
B-3	1		
B-4	1		
B-5	1		
B-6	1		
Index			
Index-1	1		
Index-2	1		
Index-3	1		
Index-4	1		
Index-5	1		
Index-6	1		
Index-7	1		
Index-8	1		

# Table of Contents

<u>Section</u>	<u>Page</u>
<b>1. INTRODUCTION</b> .....	1-1
<b>2. SYSTEM CONFIGURATIONS</b> .....	2-1
<b>3. OPERATING CONTROLS</b> .....	3-1
WI-650/660 Weather Radar Indicator Operation ...	3-1
WC-660 Weather Radar Controller Operation .....	3-10
<b>4. NORMAL OPERATION</b> .....	4-1
Preliminary Control Settings .....	4-1
Standby .....	4-4
Radar Mode – Weather .....	4-4
Radar Mode – Ground Mapping .....	4-5
Test Mode .....	4-6
<b>5. RADAR FACTS</b> .....	5-1
Radar Operation .....	5-1
Tilt Management .....	5-5
Stabilization .....	5-15
Dynamic Error .....	5-15
Accelerative Error .....	5-15
Antenna Mounting Error .....	5-16
Wallowing (Wing Walk and Yaw) Error .....	5-19
Roll Gain Error .....	5-19
Pitch Gain Error .....	5-22
Interpreting Weather Radar Images .....	5-24
Weather Display Calibration .....	5-28
Variable Gain Control .....	5-30
Rain Echo Attenuation Compensation Technique (React) .....	5-31
Shadowing .....	5-34
Turbulence Probability .....	5-34
Hail Size Probability .....	5-36
Spotting Hail .....	5-37
Azimuth Resolution .....	5-41
Radome .....	5-42
Weather Avoidance .....	5-43
Configurations of Individual Echoes (Northern Hemisphere) .....	5-47
Line Configurations .....	5-52

# Table of Contents (cont)

<u>Section</u>	<u>Page</u>
<b>5. RADAR FACTS (CONT)</b>	
Additional Hazards .....	5-55
Ground Mapping .....	5-56
<b>6. MAXIMUM PERMISSIBLE EXPOSURE LEVEL (MPEL) .....</b>	<b>6-1</b>
<b>7. IN-FLIGHT ADJUSTMENTS .....</b>	<b>7-1</b>
Pitch and Roll Trim Adjustments .....	7-1
Level Flight Stabilization Check .....	7-3
Roll Offset Adjustment .....	7-5
Pitch Offset Adjustment .....	7-8
Roll Stabilization Check .....	7-9
Roll Gain Adjustment .....	7-11
Pitch Stabilization Check .....	7-12
Pitch Gain Adjustment .....	7-15
<b>8. IN-FLIGHT TROUBLESHOOTING .....</b>	<b>8-1</b>
Test Mode With Text Faults Enabled .....	8-2
Pilot Event Marker .....	8-4
Fault Code and Text Fault Relationships .....	8-5
<b>9. HONEYWELL PRODUCT SUPPORT .....</b>	<b>9-1</b>
Publication Ordering Information .....	9-4
<b>10. ABBREVIATIONS .....</b>	<b>10-1</b>

## ■ APPENDICES

<b>A FEDERAL AVIATION ADMINISTRATION (FAA) ADVISORY CIRCULARS .....</b>	<b>A-1</b>
Subject: Recommended Radiation Safety Precautions For Ground Operation Of Airborne Weather Radar	
Purpose .....	A-1
Cancellation .....	A-1
Related Reading Material .....	A-1
Background .....	A-1
Precautions .....	A-2

# Table of Contents (cont)

<b>A</b>	<b>FEDERAL AVIATION ADMINISTRATION (FAA) ADVISORY CIRCULARS (CONT)</b>	
	Subject: Thunderstorms .....	A-3
	Purpose .....	A-3
	Cancellation .....	A-3
	Related Reading Material .....	A-3
	General .....	A-3
	Hazards .....	A-4
	National Severe Storms Laboratory (NSSL) Thunderstorm Research .....	A-10
<b>B</b>	<b>ENHANCED GROUND-PROXIMITY WARNING SYSTEM (EGPWS) .....</b>	<b>B-1</b>
	System Operation .....	B-1
	EGPWS Controls .....	B-1
	Related EGPWS System Operation .....	B-3
	EGPWS Operation .....	B-3
	EGPWS Display .....	B-4
	EGPWS Test .....	B-6
<b>INDEX</b> .....		<b>Index-1</b>

## List of Illustrations

<b>Figure</b>		<b>Page</b>
2-1	PRIMUS® 660 Configurations .....	2-2
2-2	Typical PRIMUS® 660 Weather Radar Components  .....	2-5
3-1	Typical PRIMUS® 660 Digital Weather Radar Display .....	3-1
3-2	WI-650/660 Weather Radar Indicator Front Panel View .....	3-2
3-3	WI-650/660 Weather Radar Indicator Display Screen Features .....	3-5
3-4	WC-660 Weather Radar Controller Configurations .....	3-10
4-1	EFIS Test Pattern (Typical) 120° Scan Shown ....	4-3
4-2	Indicator Test Pattern 120° Scan (WX), With TEXT FAULT Enabled .....	4-3

# Table of Contents (cont)

## List of Illustrations (cont)

<b>Figure</b>		<b>Page</b>
5-1	Positional Relationship of an Airplane and Storm Cells Ahead as Displayed on Indicator . . . . .	5-2
5-2	Antenna Beam Slicing Out Cross Section of Storm During Horizontal Scan . . . . .	5-3
5-3	Sea Returns . . . . .	5-4
5-4	Radar Beam Illumination High Altitude 12-Inch Radiator . . . . .	5-5
5-5	Radar Beam Illumination High Altitude 18-Inch Radiator . . . . .	5-5
5-6	Radar Beam Illumination Low Altitude 12-Inch Radiator . . . . .	5-6
5-7	Radar Beam Illumination Low Altitude 18-Inch Radiator . . . . .	5-6
5-8	Ideal Tilt Angle . . . . .	5-10
5-9	Earth's Curvature . . . . .	5-10
5-10	Convective Thunderstorms . . . . .	5-11
5-11	Unaltered Tilt . . . . .	5-11
5-12	Proper Tilt Technique . . . . .	5-12
5-13	Tilt Management With Heading Changes . . . . .	5-12
5-14	Fast Developing Thunderstorm . . . . .	5-13
5-15	Low Altitude Tilt Management . . . . .	5-13
5-16	Antenna Size and Impact on Tilt Management . . . . .	5-14
5-17	Rules of Thumb . . . . .	5-14
5-18	Symmetrical Ground Returns . . . . .	5-17
5-19	Ground Return Indicating Misalignment (Upper Right) . . . . .	5-18
5-20	Ground Return Indicating Misalignment (Upper Left) . . . . .	5-18
5-21	Symmetrical Ground Returns – Good Roll Stabilization . . . . .	5-20
5-22	Understabilization in a Right Turn . . . . .	5-20
5-23	Overstabilization in a Right Turn . . . . .	5-21
5-24	Roll Stabilization Inoperative in a Turn . . . . .	5-21
5-25	Symmetrical Ground Returns – Good Pitch Stabilization . . . . .	5-22
5-26	Understabilized in Pitch-Up . . . . .	5-23
5-27	Overstabilized in Pitch-Up . . . . .	5-23
5-28	Weather Radar Images . . . . .	5-24
5-29	Radar and Visual Cloud Mass . . . . .	5-26
5-30	Squall Line . . . . .	5-27
5-31	REACT ON and OFF Indications . . . . .	5-33

# Table of Contents (cont)

## List of Illustrations (cont)

<b>Figure</b>	<b>Page</b>
5-32 Probability of Turbulence Presence in a Weather Target .....	5-35
5-33 Hail Size Probability .....	5-37
5-34 Rain Coming From Unseen Dry Hail .....	5-38
5-35 Familiar Hailstorm Patterns .....	5-38
5-36 Overshooting a Storm .....	5-39
5-37 Short- and Long-Blind Alley .....	5-40
5-38 Azimuth Resolution in Weather Modes .....	5-41
5-39 Weather Display .....	5-43
5-40 Typical Hook Pattern .....	5-48
5-41 V-Notch Echo, Pendant Shape .....	5-49
5-42 The Classic Pendant Shape .....	5-50
5-43 Rain Gradients .....	5-51
5-44 Crescent Shape .....	5-52
5-45 Line Echo Wave Pattern (LEWP) .....	5-53
5-46 Bow-Shaped Line of Thunderstorms .....	5-54
5-47 Ground Mapping Display .....	5-56
6-1 MPEL Boundary .....	6-1
7-1 Symmetrical Ground Returns .....	7-4
7-2 Ground Return Indicating Misalignment (Right) ...	7-4
7-3 Ground Return Indicating Misalignment (Left) ...	7-5
7-4 Roll Offset Adjustment Display – Initial .....	7-7
7-5 Roll Offset Adjustment Display – Final .....	7-7
7-6 Symmetrical Ground Returns, Level Flight and Good Roll Stabilization .....	7-10
7-7 Understabilization in a Right Roll .....	7-10
7-8 Overstabilization in a Right Roll .....	7-11
7-9 Level Flight and Good Pitch Stabilization .....	7-13
7-10 Understabilized in Pitch Up .....	7-14
7-11 Overstabilized in Pitch Up .....	7-14
8-1 Fault Annunciation on Weather Indicator With TEXT FAULT Fields .....	8-3
8-2 Fault Code on EFIS Weather Display With TEXT FAULTS Disabled .....	8-3
8-3 Radar Indication With Text Fault Enabled (On Ground) .....	8-4
A-1 Schematic Cross Section of a Thunderstorm .....	A-6

# Table of Contents (cont)

## List of Illustrations (cont)

<b>Figure</b>	<b>Page</b>
B-1 EHSI Display Over KPHX Airport With the EGPWS Display .....	B-5
B-2 EGPWS Test Display .....	B-6

## List of Tables

<b>Table</b>	<b>Page</b>
2-1 Dual Control Mode Truth Table .....	2-3
2-2 PRIMUS® 660 Weather Radar Equipment List .....	2-4
3-1 Target Alert Characteristics .....	3-4
3-2 Rainfall Rate Color Coding .....	3-6
3-3 WC-660 Controller Target Alert Characteristics ...	3-12
3-4 Rainfall Rate Color Coding .....	3-14
4-1 PRIMUS® 660 Power-Up Procedure .....	4-1
5-1 Approximate Tilt Setting for Minimal Ground Target Display 12-Inch Radiator .....	5-8
5-2 Approximate Tilt Setting for Minimal Ground Target Display 18-Inch Radiator .....	5-9
5-3 Stabilization in Straight and Level Flight Check Procedure .....	5-17
5-4 Stabilization in Turns Check Procedure .....	5-19
5-5 Pitch Stabilization In-Flight Check Procedure ....	5-22
5-6 Display Levels Related to dBZ Levels (Typical) ....	5-29
5-7 VIP Levels Related to dBZ .....	5-30
5-8 Turbulence Levels (From Airman's Information Manual) .....	5-36
5-9 Severe Weather Avoidance Procedures .....	5-43
5-10 TILT Setting for Maximal Ground Target Display 12-Inch Radiator .....	5-57
5-11 TILT Setting for Maximal Ground Target Display 18-Inch Radiator .....	5-58
7-1 Pitch and Roll Trim Adjustments Criteria .....	7-1
7-2 Stabilization in Straight and Level Flight Check Procedure .....	7-3
7-3 In-Flight Roll Offset Adjustment Procedure .....	7-5

# Table of Contents (cont)

## List of Tables (cont)

<b><u>Table</u></b>	<b><u>Page</u></b>
7-4 Pitch Offset Adjustment Procedure .....	7-8
7-5 Roll Stabilization (While Turning) Check Procedure .....	7-9
7-6 Roll Gain Adjustment Procedure .....	7-11
7-7 Pitch Stabilization Check Procedure .....	7-12
7-8 Pitch Gain Adjustment Procedure .....	7-15
8-1 Fault Data Fields .....	8-2
8-2 Text Faults .....	8-5
8-3 Pilot Messages .....	8-8
■ B-1 EGPWS Obstacle Display Color Definitions .....	B-4



# 1. Introduction

The PRIMUS® 660 Digital Weather Radar System is a lightweight, X-band digital radar with alphanumeric display designed for weather detection (WX) and ground mapping (GMAP).

The primary purpose of the system is to detect storms along the flightpath and give the pilot a visual indication in color of their rainfall intensity. After proper evaluation, the pilot can chart a course to avoid these storm areas.

## WARNING

**THE SYSTEM PERFORMS THE FUNCTIONS OF WEATHER DETECTION OR GROUND MAPPING. IT SHOULD NOT BE USED NOR RELIED UPON FOR PROXIMITY WARNING OR ANTICOLLISION PROTECTION.**

In weather detection mode, storm intensity levels are displayed in four bright colors contrasted against a deep black background. Areas of very heavy rainfall appear in magenta, heavy rainfall in red, less severe rainfall in yellow, moderate rainfall in green, and little or no rainfall in black (background). If selected at installation, the antenna sweep position indicator is a yellow band at the top of the display.

Range marks and identifying numerics, displayed in contrasting colors, are provided to facilitate evaluation of storm cells.

Selection of the GMAP function causes the system parameters to be optimized to improve resolution and enhance identification of small targets at short ranges. The reflected signal from ground surfaces is displayed as magenta, yellow, or cyan (most to least reflective).

**NOTE:** Section 5, Radar Facts, describes a variety of radar operating topics. It is recommended that you read Section 5, Radar Facts, before learning the specific operational details of the PRIMUS® 660 Digital Weather Radar System.

The radar indicator is equipped with the universal digital interface (UDI). This feature expands the use of the radar indicator to display information such as checklists, short and long range navigation displays (when used with a Honeywell DATA NAV™ system) and electrical discharge data from Honeywell's LSZ-850 Lightning Sensor System (LSS).

**NOTE:** Refer to Honeywell Pub. 28-1146-54, LSZ-850 Lightning Sensor System Pilot's Handbook, for more information.

## 2. System Configurations

The PRIMUS® 660 Digital Weather Radar System can be operated in many configurations to display weather or ground mapping information on a radar indicator, electronic flight instrument system (EFIS) display, multifunction display (MFD), or on a combination of these displays. The various system configurations are summarized in the following paragraphs and shown in figure 2-1.

**NOTE:** Other configurations are possible but not illustrated.

The stand-alone configuration consists of two units: receiver transmitter antenna (RTA), and a dedicated radar indicator. In this configuration, the radar indicator contains all the controls to operate the PRIMUS® 660 Digital Weather Radar System. A single or dual Honeywell EFIS can be added to the stand-alone configuration. In such a case the electronic horizontal situation indicator (EHSI) repeats the data displayed on the radar indicator. System control remains with the radar indicator.

The second system configuration uses an RTA, and single or dual controllers. The single or dual EFIS is the radar display. Since there is no radar indicator in this configuration, the radar system operating controls are located on the controller. With a single controller, all cockpit radar displays are identical.

The dual configuration gives the appearance of having two radar systems on the aircraft. In the dual configuration, the pilot and copilot each select independent radar mode, range, tilt, and gain settings for display on their respective display. The dual configuration time shares the RTA. On the right-to-left antenna scan, the system switches to the mode, range, tilt, and gain selected by the left controller and updates the left display. On the reverse antenna scan, the system switches to the mode, range, tilt, and gain setting selected by the right controller and updates the right display. Either controller can be slaved to the other controller to show identical images on both sides of the cockpit.

- NOTES:**
1. When WAIT, SECTOR SCAN, or FORCED STANDBY are activated, the radar operates as if in single controller configuration. This is an exception to the ability of each pilot to independently select modes.
  2. In the dual configuration, the pilots can use the slave feature to optimize the update rate of each side's weather radar display to meet the needs of the situation. With one controller turned off, both cockpit displays are updated on every sweep of the radar, but control of the radar is only on one side. With each controller operating, each side has control but each side is updated with new radar information on every other sweep of the antenna.

**STAND-ALONE CONFIGURATION**

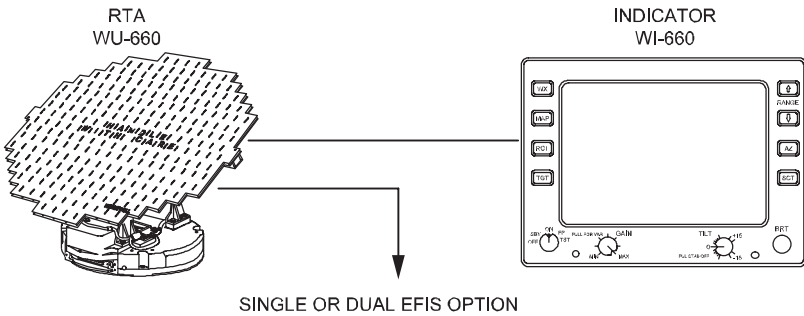

**EFIS OR EFIS / MFD CONFIGURATION**

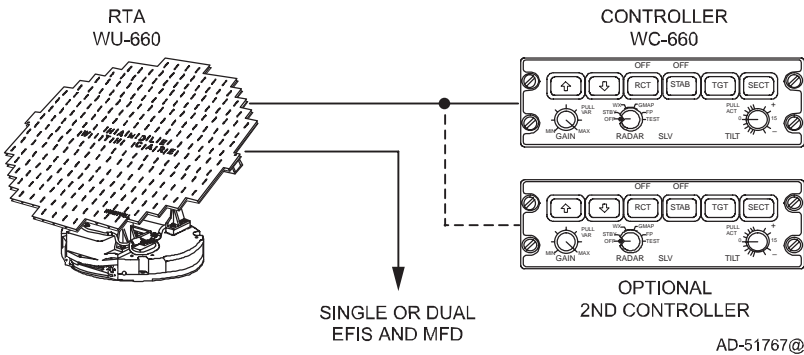

AD-51767@

**PRIMUS® 660 Configurations  
Figure 2-1**

The third system configuration is similar to the second except that a Honeywell multifunction display (MFD) system is added. As before, single or dual controllers can be used. When a single controller is used, all displays show the same radar data. Dual controllers are used to operate in the dual mode. The MFD can be slaved to either controller to duplicate the data displayed on the selected side. Table 2–1 is a truth table for dual control modes.

<b>Left Controller Mode</b>	<b>Right Controller Mode</b>	<b>Left Side (NOTE 1)</b>	<b>Right Side (NOTE 1)</b>	<b>RTA Mode</b>
OFF	OFF	OFF	OFF	OFF
OFF	Standby	"SLV" Standby	Standby	Standby
Standby	OFF	Standby	"SLV" Standby	Standby
OFF	ON	"SLV" ON	ON	ON
ON	OFF	ON	"SLV" ON	ON
Standby	ON	Standby/ 2	ON/2	ON
ON	Standby	ON/2	Standby/2	ON
ON	ON	ON/2	ON/2	ON
Standby	Standby	Standby	Standby	Standby

### **Dual Control Mode Truth Table**

**Table 2–1**

- NOTES:**
1. ON is used to indicate any selected radar mode.
  2. "SLV" means that displayed data is controlled by opposite side controller. That is, the one controller that is operating is controlling both sweeps of the antenna.
  3. XXX/2 means that display is controlled by appropriate on–side control for the antenna sweep direction associated with that control. (/2 implies two controllers are ON.)
  4. In standby, the RTA is centered in azimuth with 15° upward tilt. Video data is suppressed. The transmitter is inhibited.
  5. The MFD, if used, can repeat either left– or right–side data, depending upon external switch selection.

Equipment covered in this manual is listed in table 2-2 and shown in figure 2-2.

<b>Model</b>	<b>Unit</b>	<b>Part No.</b>
<b>Cockpit Mounted Options</b>		
WI-650/660	Weather Radar Indicator	7007700-VAR
WC-660	Weather Radar Controller	7008471-VAR
<b>Remote Mounted Equipment</b>		
WU-660	Receiver Transmitter Antenna	7021450-601
<b>NOTES:</b> 1. Typically, either the indicator or one of the remote controllers (one or two) is installed. 2. Typical installed antenna sizes range from 12 to 18 inches in diameter.		

**PRIMUS® 660 Weather Radar Equipment List**  
**Table 2-2**

**NOTE:** A WC-650 Weather Radar Controller can be installed. Except as noted, its operation is identical to the WC-660 Weather Radar Controller.

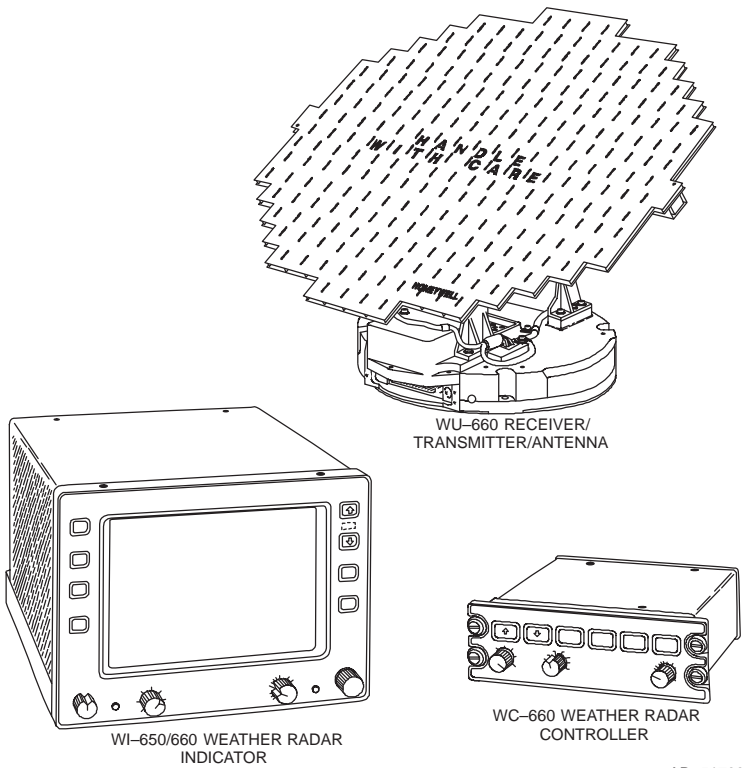

AD-51768@

**Typical PRIMUS® 660 Weather Radar Components**  
**Figure 2-2**

### 3. Operating Controls

There are two basic controllers that are described in this section. They are (in order of description):

- WI-650/660 Weather Radar Indicator
- WC-660 Weather Radar Controller.

#### WI-650/660 WEATHER RADAR INDICATOR OPERATION

All controls used to operate the system display shown in figure 3-1, are located on the WI-650/660 Weather Radar Indicator front panel.

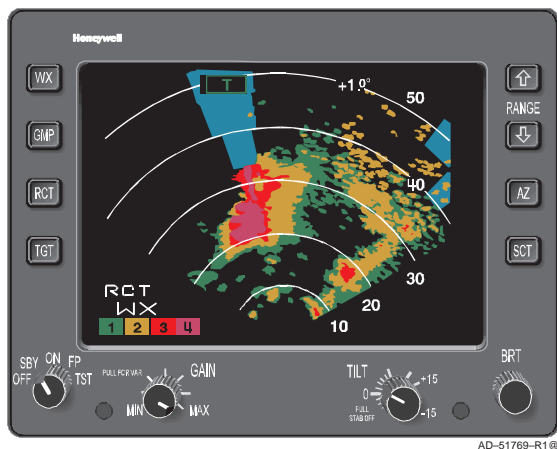

**Typical PRIMUS® 660 Digital  
Weather Radar Display  
Figure 3-1**

The controls and display features of the WI-650/660 Weather Radar Indicator are indexed and identified in figure 3-2. Brightness levels for all legends and controls on the indicator are controlled by the dimming bus for the aircraft panel.



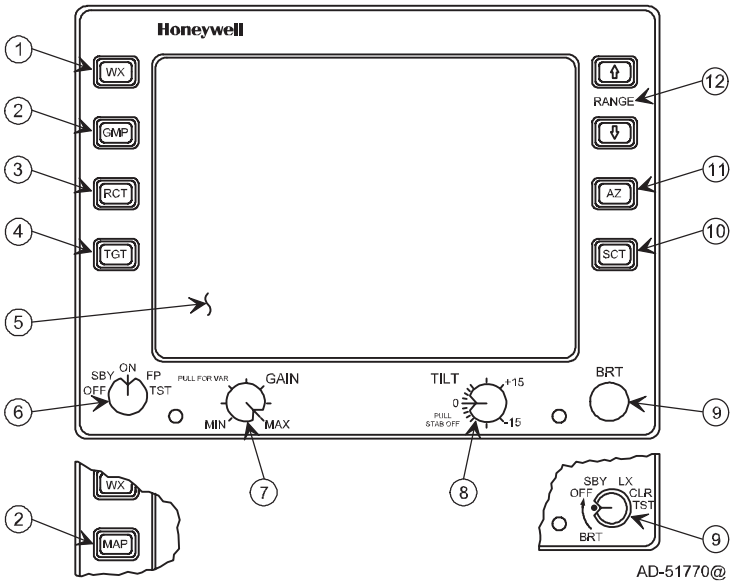

**WI-650/660 Weather Radar Indicator Front Panel View  
Figure 3-2**

**1 WX (WEATHER)**

The WX button is used to select the weather mode of operation. When WX is pushed, the system is fully operational and all internal parameters are set for enroute weather detection.

Alphanumerics are white, and WX is displayed in the mode field.

If WX is selected prior to the expiration of the initial RTA warm up period, the white WAIT legend is displayed in the mode field. In wait mode, the transmitter and antenna scan is inhibited and the memory is erased. Upon completion of the warmup period, the system automatically switches to WX mode.

WX can only be selected when the function switch is in the ON position.

**2 GMP (GROUND MAPPING) OR MAP**

GMP button selects the ground mapping mode. The system is fully operational and all parameters are set to enhance returns from ground targets.

**NOTE:** REACT or TGT modes are not selectable in GMP.

## WARNING

**WEATHER TYPE TARGETS ARE NOT CALIBRATED WHEN THE RADAR IS IN THE GMAP MODE. BECAUSE OF THIS, DO NOT USE THE GMAP MODE FOR WEATHER DETECTION.**

As a constant reminder the GMP is selected, the alphanumeric are changed to green, the GMP legend is shown in the mode field, and the color scheme is changed to cyan, yellow, and magenta. Cyan represents the least reflective return, yellow is a moderated return, and magenta is a strong return.

If GMP is selected before the initial RTA warmup period is complete, the white WAIT legend is shown in the mode field. In wait mode, the transmitter and antenna scan are inhibited and the memory is erased. When the warmup period is complete, the system automatically switches to the GMP mode.

GMP can only be selected when the function switch is in the ON position.

### **3 RCT (RAIN ECHO ATTENUATION COMPENSATION TECHNIQUE (REACT))**

The RCT switch is an alternate-action switch that enables and disables REACT.

The REACT circuitry compensates for attenuation of the radar signal as it passes through rainfall. The cyan field indicates areas where further compensation is not possible. Any target detected within the cyan field cannot be calibrated and should be considered dangerous. All targets in the cyan field are displayed as fourth level precipitation, magenta.

REACT is available in the WX mode only, and selecting REACT forces the system to preset gain. When engaged, the white RCT legend is displayed in the REACT field.

- NOTES:**
1. REACT'S three main functions (attenuation compensation, cyan field, and forcing targets to magenta) are switched on and off with the RCT switch.
  2. Refer to Section 5, Radar Facts, for a description of REACT.

## 4 TGT (TARGET)

The TGT button is an alternate-action switch that enables and disables the radar target alert feature. Target alert is selectable in all but the 300-mile range. When selected, target alert monitors beyond the selected range and 7.5° on each side of the aircraft heading. If a return with target alert characteristics is detected in the monitored area, the target alert legend changes from the green **T** armed condition to the yellow TGT warning condition. (See the target alert characteristics in table 3-1 for a target description.) These annunciations advise the pilot of potentially hazardous targets directly in front of the aircraft that are outside the selected range. When a yellow warning is received, the pilot should select longer ranges to view the questionable target. (Note that target alert is inactive within the selected range.)

Selecting target alert forces the system to preset gain. Target alert can be selected only in the WX or FP (flight plan) modes.

**NOTE:** In order to activate the target alert warning, the target must have the depth and range characteristics described in table 3-1.

Selected Range (NM)	Minimum Target Depth (NM)	Target Range (NM)
5	5	5-55
10	5	10-60
25	5	25-75
50	5	50-100
100	5	100-150
200	5	200-250
300	N/A	N/A
FP (Flight Plan)	5	5-55

**Target Alert Characteristics**  
**Table 3-1**

## 5 DISPLAY AREA

See figure 3–3 and the associated text that explains the alphanumeric display.

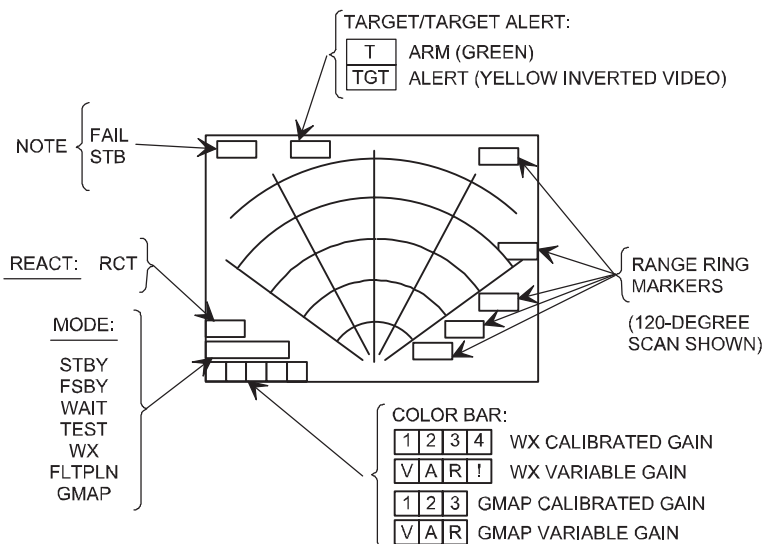

NOTE: MESSAGES ARE LISTED IN PRIORITY ORDER.

AD-51771@

**WI-650/660 Weather Radar Indicator Display Screen Features**  
**Figure 3–3**

## 6 FUNCTION SWITCH

A rotary switch is used to select the following functions:

- **OFF**– This position turns off the radar system.
- **SBY (Standby)** – This position places the radar system in standby, a ready state, with the antenna scan stopped, the transmitter inhibited, and the display memory erased. STBY, in white, is shown in the mode field.

If SBY is selected before the initial RTA warmup period is complete (approximately 90 seconds), the white WAIT legend is shown in the mode field. When warmup is complete, the system changes the mode field to SBY.

- **ON** – Places the system in the operational mode selected by the WX or MAP (GMP) button. When WX is selected, the system is fully operational and all internal parameters are set for enroute weather detection. The alphanumeric are white and WX is shown in the mode field.

If ON is selected before the initial RTA warmup period is over (approximately 90 seconds), the white WAIT legend is displayed in the mode field. In wait mode, the transmitter and antenna scan are inhibited and the display memory is erased. When the warmup is complete, the system automatically switches to the WX (or MAP) mode, as selected.

The system, in preset gain, with WX selected, is calibrated as listed in table 3–2.

Rainfall Rate		Color
in/hr	mm/hr	
.04–.16	1–4	Green
.16–.47	4–12	Yellow
.47–2	12–50	Red
> 2	>5 0	Magenta

**Rainfall Rate Color Coding**  
**Table 3–2**

- **FP (Flight Plan)** – The FP position puts the radar system in the flight plan mode, that clears the screen of radar data so ancillary data can be displayed. Examples of this data are:
  - Electronic checklists
  - Navigation displays
  - Electrical discharge (lightning) data.

**NOTE:** In the FP mode, the radar RTA is put in standby, the alphanumeric are changed to cyan, and the FLTPLN (flight plan) legend is shown in the mode field.

The TGT alert mode can be used in the FP mode. With target alert on and the FP mode selected, the target alert armed annunciation (green TGT) is displayed. The RTA searches for a hazardous target from 5 to 55 miles and  $\pm 7.5^\circ$  of the aircraft heading. No radar targets are displayed. If a hazardous target is detected, the target alert armed annunciation switches to the alert annunciation (yellow TGT). This advises the pilot that a hazardous target is in his flightpath and the WX mode should be selected to view it.

**NOTE:** The TGT function is inoperative when a checklist is displayed.

- **TST (Test)** – The TST position selects the radar test mode. A special test pattern is displayed to verify system operation. The TEST legend is shown in the mode field. Refer to Section 4, Normal Operations, for a description of the test pattern.

## WARNING

**IN THE TEST MODE THE TRANSMITTER IS ON AND RADIATING X-BAND MICROWAVE ENERGY. REFER TO SECTION 6, MAXIMUM PERMISSIBLE EXPOSURE LEVEL (MPEL), AND THE APPENDIX, FEDERAL AVIATION ADMINISTRATION (FAA) ADVISORY CIRCULARS, TO PREVENT POSSIBLE HUMAN BODY DAMAGE.**

### FSBY (FORCED STANDBY)

FSBY is an automatic, nonselectable radar mode. As an installation option, the indicator can be wired to the weight-on-wheels (WOW) squat switch. When wired, the RTA is in the FSBY mode when the aircraft is on the ground. In FSBY mode, the transmitter and antenna scan are both inhibited, and the forced standby legend is displayed in the mode field.

The FSBY mode is a safety feature that inhibits the transmitter on the ground to eliminate the X-band microwave radiation hazard. Refer to Section 6, Maximum Permissible Exposure Level (MPEL).

When in FSBY mode, you can restore normal operation by pulling the tilt control out, pushing it in, pulling it out, and pushing it in within three seconds.

## WARNING

**STANDBY OR FORCED STANDBY MODE MUST BE VERIFIED FOR GROUND OPERATION BY THE OPERATOR TO ENSURE SAFETY FOR GROUND PERSONNEL.**

## 7 GAIN

The GAIN knob is a single-turn rotary control and push/pull switch that is used to control the receiver gain. Push in on the GAIN switch to enter the system into the preset calibrated gain mode. Calibrated gain is the normal mode and is used for weather avoidance. In calibrated gain, the rotary portion of the GAIN control does nothing. In calibrated gain, the color bar legend is labeled 1,2,3,4 in WX mode or 1,2,3 in GMAP mode.

Pull out on the GAIN switch to enter the system into the variable gain mode with VAR (variance) displayed in the color bar. Variable gain is useful for additional weather analysis and for ground mapping. In WX mode, variable gain can increase receiver sensitivity over the calibrated level to show very weak targets or it can be reduced below the calibrated level to eliminate weak returns.

### WARNING

#### **HAZARDOUS TARGETS CAN BE ELIMINATED FROM THE DISPLAY WITH LOW SETTINGS OF VARIABLE GAIN.**

In the GMAP mode, variable gain is used to reduce the level of the typically very strong returns from ground targets to allow details to be seen.

Minimum gain is with the control at its full counterclockwise (ccw) position. Gain increases as the control is rotated cw from full ccw . At full clockwise (cw) position, the gain is at maximum.

In variable gain, the color bar legend contains the variable gain (VAR) annunciation. Selecting RCT or TGT forces the system into calibrated gain.

## 8 TILT

The TILT knob is a rotary control that is used to select the tilt angle of the antenna beam with relation to the horizon. CW rotation tilts beam upward to +15°; ccw rotation tilts beam downward to -15°.

### WARNING

#### **TO AVOID FLYING UNDER OR OVER STORMS, FREQUENTLY ADJUST THE TILT TO SCAN BOTH ABOVE AND BELOW YOUR FLIGHT LEVEL.**

Stabilization is normally ON. It can be turned OFF by pulling out the TILT knob. The knob is also used to operate the hidden modes. Refer to Section 8, In-Flight Troubleshooting

The radar antenna is normally attitude stabilized. It automatically compensates for roll and pitch maneuvers (refer to Section 5, Radar Facts, for a description of stabilization). The STAB OFF annunciator is displayed on the screen.

## 9 BRT (Brightness) or BRT/LSS (Lightning Sensor System)

The BRT knob is a single–turn control that adjusts the brightness of the display. CW rotation increases display brightness and ccw rotation decreases brightness.

An optional BRT/LSS four–position rotary switch selects the separate LSZ–850 Lightning Sensor System (LSS) operating modes and the brightness control on some models. Its LSS control switch positions are as follows:

- **OFF** – This position removes all power from the LSS.
- **SBY (Standby)** – This position inhibits the display of LSS data, but the system accumulates data in this mode.
- **LX (Lightning Sensor System)** – In this position the LSS is fully operational and data is being displayed on the indicator.
- **CLR/TST (Clear/Test)** – In this position accumulated data is cleared from the memory of the LSS. After 3 seconds the test mode is initiated in the LSS. Refer to the LSZ–850 Lightning Sensor System Pilot’s Handbook, for a detailed description of LSS operation.

## 10 SCT (SCAN SECTOR)

The SCT button is an alternate–action switch that is used to select either the normal 12 looks/minute 120° scan or the faster update 24 looks/minute 60° sector scan.

## 11 AZ (AZIMUTH)

The AZ button is an alternate–action switch that enables and disables the electronic azimuth marks. When enabled, azimuth marks at 30° intervals are displayed. The azimuth marks are the same color as the other alphanumeric.

## 12 RANGE

The RANGE buttons are two momentary–contact buttons used to select the operating range of the radar. The range selections are from 5 to 300 NM full scale. In FP mode, additional ranges of 500 and 1000 NM are available. The up arrow selects increasing ranges, and the down arrow selects decreasing ranges. Each of the five range rings on the display has an associated marker that annunciates its range.



## WC-660 WEATHER RADAR CONTROLLER OPERATION

The controls and display features of the WC-660 Weather Radar Controller are indexed and identified in figure 3-4. Brightness levels for all legends and controls on the indicator are controlled by the dimming bus for the aircraft panel.

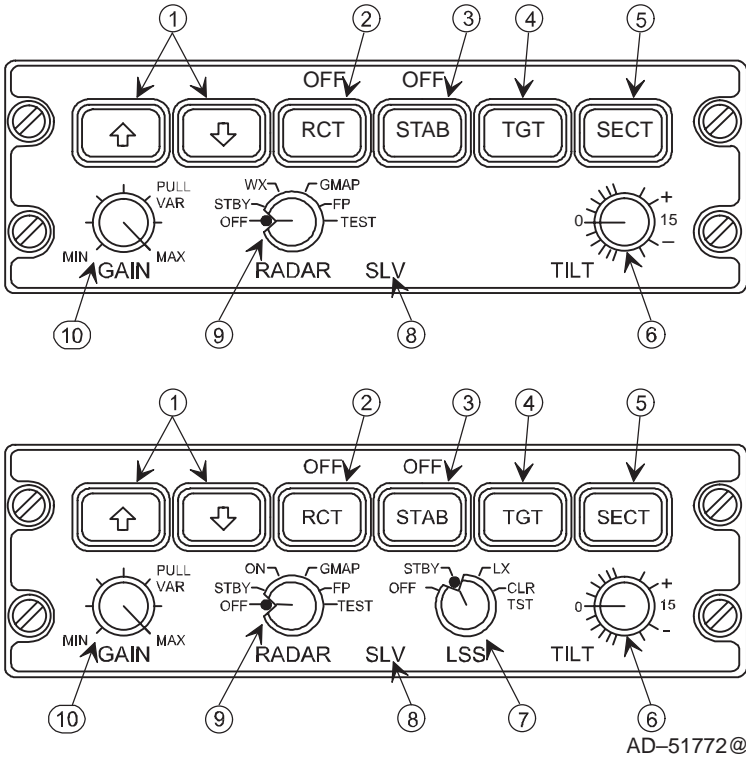

**WC-660 Weather Radar Controller Configurations**  
**Figure 3-4**

- NOTES:**
1. A WC-650 Weather Radar Controller can be installed in the aircraft. Consult the aircraft installed equipment configuration listing for details. Except as noted, operation of the WC-650 Weather Radar Controller is identical to the WC-660 Weather Radar Controller.
  2. Controllers are available with and without the LSS function.
  3. When single or dual radar controllers are used, the radar data is displayed on the EFIS, and/or an MFD or navigation display (ND).

## 1 RANGE

The RANGE switches are two momentary contact buttons that are used to select the operating range of the radar (and LSS if installed). The system permits selection of ranges in WX mode from 5 to 300 NM full scale. In the flight plan (FPLN) mode, additional ranges of 500 and 1000 miles are permitted. The up arrow selects increasing ranges, while the down arrow selects decreasing ranges. One-half the selected range is annunciated at the one-half scale range mark on the EHSI.

**NOTE:** Some integrated avionics systems incorporate radar range with the map display range control on a MFD/ND display.

## 2 RCT (RAIN ECHO ATTENUATION COMPENSATION TECHNIQUE REACT)

This switch position turns on RCT.

The REACT circuitry compensates for attenuation of the radar signal as it passes through rainfall. The cyan field indicates areas where further compensation is not possible. Any target detected within the cyan field cannot be calibrated and should be considered dangerous. All targets in the cyan field are displayed as fourth level precipitation, magenta.

RCT is a submode of the WX mode and selecting RCT forces the system to preset gain. When RCT is selected, the RCT legend is displayed on the EFIS/MFD.

- NOTES:**
1. REACT'S three functions (attenuation compensation, cyan field, and forcing targets to magenta) are switched on and off with the RCT switch.
  2. Refer to Section 5, Radar Facts, for a description of REACT.

## 3 STAB (STABILIZATION)

The STAB button turns the pitch and roll stability ON and OFF. It is also used with the hidden modes.

**NOTE:** Some controllers annunciate OFF when stabilization is OFF.

**4 TGT (TARGET)**

The TGT switch is an alternate-action, button that enables and disables the radar target alert feature. Target alert is selectable in all but the 300-mile range. When selected, target alert monitors beyond the selected range and 7.5° on each side of the aircraft heading. If a return with certain characteristics is detected in the monitored area, the target alert changes from the green armed condition to the yellow TGT warning condition. This annunciation advises the pilot that a potentially hazardous target lies directly in front and outside of the selected range. When this warning is received, the pilot should select longer ranges to view the questionable target. Note that target alert is inactive within the selected range.

Selecting target alert forces the system to preset gain. Target alert can only be selected in the WX and FP modes.

In order to activate target alert, the target must have the depth and range characteristics described in table 3-3.

Selected Range (NM)	Minimum Target Depth (NM)	Target Range (NM)
5	5	5-55
10	5	10-60
25	5	25-75
50	5	50-100
100	5	100-150
200	5	200-250
300	N/A	N/A
FP (Flight Plan)	5	5-55

**WC-660 Controller Target Alert Characteristics**  
**Table 3-3**

**NOTE:** When on the ground, in FSBY mode, pushing STAB four times in three seconds, overrides forced standby.

**5 SECT (SCAN SECTOR)**

The SECT switch is an alternate-action button that is used to select either the normal 12 looks/minute 120° scan or the faster update 24 looks/minute 60° sector scan.

## 6 TILT

The TILT knob is a rotary control that is used to select the tilt angle of antenna beam with relation to the horizon. CW rotation tilts beam upward 0° to 15°; ccw rotation tilts beam downward 0° to -15°. The range between +5° and -5° is expanded for ease of setting. A digital readout of the antenna tilt angle is displayed on the EFIS.

### WARNING

**TO AVOID FLYING UNDER OR OVER STORMS, FREQUENTLY ADJUST THE TILT TO SCAN BOTH ABOVE AND BELOW YOUR FLIGHT LEVEL.**

## 7 LSS (LIGHTNING SENSOR SYSTEM) (OPTIONAL)

The LSS switch is an optional four-position rotary switch that selects the LSS operating modes described below:

- **OFF** – In this position all power is removed from the LSS.
- **SBY (Standby)** –In this position the display of LSS data is inhibited, but the LSS still accumulates data.
- **LX (Lightning Sensor System)** –In this position the LSS is fully operational and it displays LSS data on the indicator.
- **CLR/TST (Clear/Test)** –In this position, accumulated data is cleared from the memory of the LSS. After 3 seconds the test mode is initiated in the LSS.

## 8 SLV (SLAVE) (DUAL INSTALLATIONS ONLY)

The SLV annunciator is only used in dual controller installations. With dual controllers, one controller can be slaved to the other by selecting OFF on that controller only, with the RADAR mode switch. This slaved condition is annunciated with the SLV annunciator. The slave mode allows one controller to set the modes of the RTA for both sweep directions. In the slave mode, all EFIS WX displays are identical and updated on each sweep.

With dual controllers, both controllers must be off before the radar system turns off.

**9 RADAR**

This rotary switch is used to select one of the following functions.

- **OFF** – This position turns off the radar system.
- **STBY (Standby)** – This position places the radar system in standby; a ready state, with the antenna scan stopped, the transmitter inhibited, and the display memory erased. STBY is displayed on the EFIS/MFD.
- **WX (Weather)** – This position selects the weather detection mode. The system is fully operational and all internal parameters are set for enroute weather detection.

If WX is selected before the initial RTA warmup period is complete (approximately 45 to 90 seconds), the WAIT legend is displayed on the EFIS/MFD. In WAIT mode, the transmitter and antenna scan are inhibited and the display memory is erased. When the warmup is complete, the system automatically switches to the WX mode.

The system, in preset gain, is calibrated as described in table 3–4.

Rainfall Rate		Color
in/hr	mm/hr	
.04–.16	1–4	Green
.16–.47	4–12	Yellow
.47–2	12–50	Red
> 2	>5 0	Magenta

**Rainfall Rate Color Coding**  
**Table 3–4**

- **GMAP (Ground Mapping)** – The GMAP position puts the radar system in the ground mapping mode. The system is fully operational and all parameters are set to enhance returns from ground targets.

**NOTE:** REACT or TGT modes are not selectable in GMAP.

**WARNING**

**WEATHER TYPE TARGETS ARE NOT CALIBRATED WHEN THE RADAR IS IN THE GMAP MODE. BECAUSE OF THIS, DO NOT USE THE GMAP MODE FOR WEATHER DETECTION.**

As a constant reminder that GMAP is selected, the GMAP legend is displayed in the mode field, and the color scheme is changed to cyan, yellow, and magenta. Cyan represents the least reflective return, yellow is a moderate return, and magenta is a strong return.

If GMAP is selected before the initial RTA warmup period is complete (approximately 45 to 90 seconds), the white WAIT legend is displayed in the mode field. In wait mode, the transmitter and antenna scan are inhibited and the memory is erased. When the warmup period is complete, the system automatically switches to the GMAP mode.

**NOTE:** Some installations have controllers that have a WX/GMAP select switch. In this case, the radar mode switch provides an ON selection. The separate WX/GMAP switch is used to select either WX (weather) or GMAP (ground mapping).

- **FP (Flight Plan)** – The FP position puts the radar system in the flight plan mode, that clears the screen of radar data. This allows the radar controller to select a range for display (on EFIS) of mapping information at very long ranges.

**NOTE:** In the FP mode, the radar RTA is put in standby, and the FLTPLN legend is displayed in the mode field.

The target alert mode can be used in the FP mode. With target alert on and the FP mode selected, the target alert armed annunciation (green TGT) is displayed. The RTA searches for a hazardous target from 5 to 55 miles and  $\pm 7.5$  degrees of dead ahead. No radar targets are displayed. If a hazardous target is detected, the target alert armed annunciation switches to the alert annunciation (amber TGT). This advises the pilot that a hazardous target is in his flightpath and he should select the WX mode to view it.

**NOTE:** When displaying checklist, the TGT function is inoperative.

- **TST (Test)** – The TST position selects the radar test mode. A special test pattern is displayed to verify system operation. The TEST legend is displayed in the mode field. Refer to Section 4, Normal Operation, for a description of the test pattern.

## WARNING

**IN THE TEST MODE, THE TRANSMITTER IS ON AND RADIATING X-BAND MICROWAVE ENERGY. REFER TO SECTION 6, MAXIMUM PERMISSIBLE EXPOSURE LEVEL (MPEL).**

## **FSBY (FORCED STANDBY)**

FSBY is an automatic, nonselectable radar mode. As an installation option, the RTA can be wired to the weight-on-wheels (WOW) squat switch. When wired, the RTA is in the FSBY mode when the aircraft is on the ground. In FSBY mode, the transmitter and antenna scan are both inhibited, the display memory is erased, and the FSBY legend is displayed in the mode field. When in the FSBY mode, pushing the STAB button four times in three seconds restores normal operation.

**NOTE:** If a WC-650 Weather Radar Controller is installed, FSBY is overridden by simultaneously pushing both range arrow buttons.

The FSBY mode is a safety feature that inhibits the transmitter on the ground to eliminate the X-band microwave radiation hazard. Refer to Section 6, Maximum Permissible Exposure Level (MPEL).

## **WARNING**

**STANDBY OR FORCED STANDBY MODE MUST BE VERIFIED IN GROUND OPERATIONS BY THE OPERATOR TO ENSURE SAFETY FOR GROUND PERSONNEL.**

In installations with two radar controllers, it is only necessary to override forced standby from one controller.

If either controller is returned to standby mode while weight is on wheels, the system returns to the forced standby mode.

## **10 GAIN**

The GAIN is a single turn rotary control and push/pull switch that is used to control the receiver gain. When the GAIN switch is pushed, the system enters the preset, calibrated gain mode. Calibrated gain is the normal mode and is used for weather avoidance. In calibrated gain, the rotary portion of the GAIN control does nothing.

When the GAIN switch is pulled out, the system enters the variable gain mode. Variable gain is useful for additional weather analysis and for ground mapping. In WX mode, variable gain can increase receiver sensitivity over the calibrated level to show weak targets or it can be reduced below the calibrated level to eliminate weak returns.

## **WARNING**

**LOW VARIABLE GAIN SETTINGS CAN ELIMINATE HAZARDOUS TARGETS FROM THE DISPLAY.**

In GMAP mode, variable gain is used to reduce the level of strong returns from ground targets.

Minimum gain is attained with the control at its full ccw position. Gain increases as the control is rotated in a cw direction from full ccw at full cw position, the gain is at maximum.

The VAR legend annunciates variable gain. Selecting RCT or TGT forces the system into calibrated gain.

**NOTE:** Some controllers have a preset position on the rotary knob. Rotating the knob to PRESET provides calibrated gain functions. Rotating the knob out of the PRESET position allows variable gain operation.



## 4. Normal Operation

### PRELIMINARY CONTROL SETTINGS

Table 4–1 gives the power–up procedure for the PRIMUS® 660 Digital Weather Radar System.

Step	Procedure
1	<p>Verify that the system controls are in the positions described below before powering up the radar system.</p> <p>Mode control: Off            GAIN control: Preset Position            TILT control: +15</p>
2	<p>Take the following precautions if the radar system is operated in any mode other than standby or forced standby while the aircraft is on the ground:</p> <ul style="list-style-type: none"> <li>• Direct nose of aircraft so that antenna scan sector is free of large metallic objects, such as hangars or other aircraft for a minimum distance of 100 feet (30 meters), and tilt the antenna fully upwards.</li> <li>• Do not operate the radar system during aircraft refueling or during refueling operations within 100 feet (30 meters).</li> <li>• Do not operate the radar if personnel are standing too close to the 120° forward sector of aircraft. (Refer to Section 6, Maximum Permissible Exposure Level, in this manual.)</li> <li>• Operating personnel should be familiar with FAA AC 20–68B, which is reproduced in Appendix A of this manual.</li> </ul>
3	<p>If the system is being used with an EFIS display, power–up by selecting the weather display on the EHSI. Apply power to the radar system using either the indicator or controller power controls.</p>
4	<p>Select either standby or test mode, as shown in figure 4–1.</p>

**PRIMUS® 660 Power–Up Procedure**  
**Table 4–1 (cont)**

Step	Procedure
5	<p>When power is first applied, the radar is in WAIT for approximately 90 seconds to allow the magnetron to warm up. Power interruptions lasting less than 3 seconds result in a 6-second wait period.</p> <p><b>NOTE:</b> If forced standby is incorporated, it is necessary to exit forced standby.</p> <p style="text-align: center;"><b>WARNING</b></p> <p style="text-align: center;"><b>OUTPUT POWER IS RADIATED IN TEST MODE.</b></p>
6	<p>After the warm-up, select the test mode and verify that the test pattern is displayed, as shown in figure 4-2. If the radar is being used with an EFIS, the test pattern is similar. The antenna position indicator (API) is shown as a yellow arc at the top of the display.</p> <p><b>NOTE:</b> The API (a strap option) paints and unpaints on alternate sweeps to supply a continuous indication of picture bus activity. The color of the text does not change on alternate sweeps.</p>
7	<p>Verify that the azimuth marks, target alert (TGT), and sector scan controls are operational.</p>

**PRIMUS® 660 Power-Up Procedure**  
**Table 4-1**

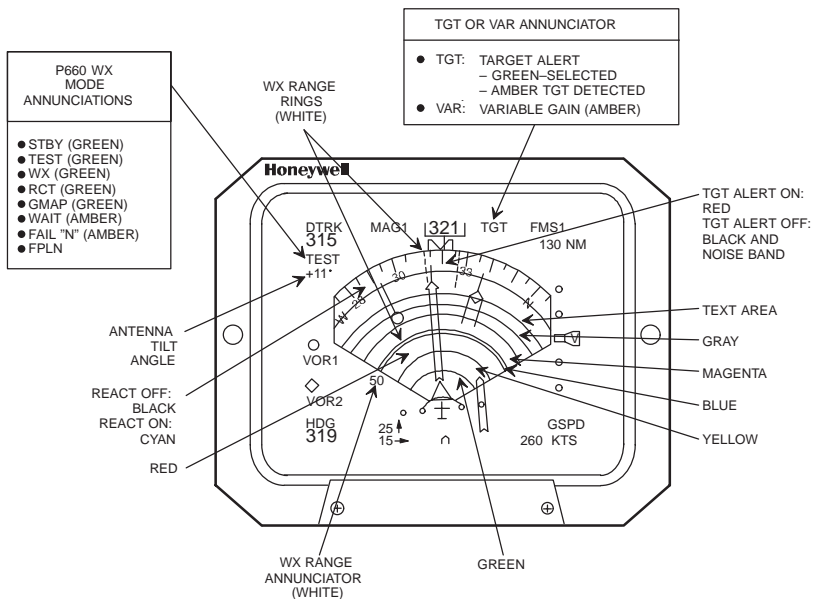

- NOTES:
1. IF THE BITE DETECTS A FAULT IN TEST MODE, FAIL "N" WILL BE SHOWN. "N" IS A FAULT CODE.
  2. ANY FAULT CODE CAN ALSO BE DISPLAYED IN THE MAINTENANCE MODE. IN THAT CASE, IT REPLACES THE ANTENNA TILT ANGLE.

AD-51774@

### EFIS Test Pattern (Typical) 120° Scan Shown Figure 4-1

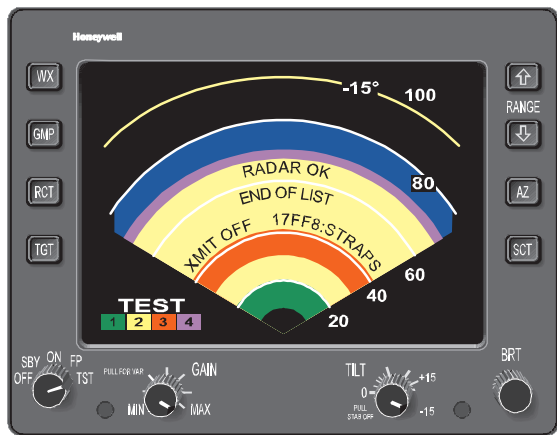

### Indicator Test Pattern 120° Scan (WX), With TEXT FAULT Enabled Figure 4-2

- NOTES:**
1. Refer to the specific EFIS manual for a detailed description.
  2. The example shown is for installations with TEXT FAULT disabled.

## Standby

When Standby is selected, and the radar is not in dual control mode (refer to table 2–1, dual control mode truth table, for dual control operation), the antenna is stowed in a tilt-up position and is neither scanning nor transmitting.

Standby should be selected when the pilot wants to keep power applied to the radar without transmitting.

## Radar Mode – Weather

For purposes of weather avoidance, pilots should familiarize themselves with FAA Advisory Circular AC 00–24B (1–20–83). Subject: "Thunderstorms." The advisory circular is reproduced in Appendix A of this manual.

To help the pilot categorize storms as described in the advisory circular referenced above, the radar receiver gain is calibrated in the WX mode with the GAIN control in the preset position. The radar is not calibrated when variable gain is being used, but calibration is restored if RCT or target alert (TGT) is selected.

To aid in target interpretation, targets are displayed in various colors. Each color represents a specific target intensity. The intensity levels chosen are related to the National Weather Service (NWS) video integrated processor (VIP) levels.

In the WX mode, the system displays five levels as black, green, yellow, red, and magenta in increasing order of intensity.

If RCT is selected, the radar receiver adjusts the calibration automatically to compensate for attenuation losses, as the radar pulse passes through weather targets on its way to illuminate other targets.

There is a maximum extent to which calibration can be adjusted. When this maximum value is reached, REACT compensation ceases. At this point, a cyan field is added to the display to indicate that no further compensation is possible.

In the absence of intervening targets, the range at which the cyan field starts is approximately 290 NM with a 12–inch antenna. For the 18–inch antenna, the cyan field starts beyond 300 NM and therefore is not seen if there are no intervening targets.

The RCT feature includes attenuation compensation (Refer to Section 5, Radar Facts, for a description of attenuation compensation.). Rainfall causes attenuation and attenuation compensation modifies the color calibration to maintain calibration regardless of the amount of attenuation. Modifying the color calibration results in a change in the point where calibration can no longer keep the radar system calibrated for red level targets. The heavier the rainfall, the greater the attenuation and the shorter the range where extended sensitivity time control (XSTC) runs out of control. Therefore, the range at which the cyan background starts varies depending on the amount of attenuation. The greater the attenuation, the closer the start of the cyan field.

The radar's calibration includes a nominal allowance for radome losses. Excessive losses in the radome seriously affect radar calibration. One possible means of verification are signal returns from known targets. Honeywell recommends that the pilot report evidence of weak returns to ensure that radome performance is maintained at a level that does not affect radar calibration.

Target alert can be selected in any WX range. The target alert circuit monitors for hazardous targets within  $\pm 7.5^\circ$  of the aircraft centerline.

## Radar Mode – Ground Mapping

**NOTE:** Refer to Tilt Management in Section 5, Radar Facts, for additional information on the use of tilt control.

Ground–mapping operation is selected by setting the controls to GMAP. The TILT control is turned down until a usable amount of navigable terrain is displayed. The degree of down–tilt depends on the aircraft altitude and the selected range.

The receiver sensitivity time control (STC) characteristics are altered to equalize ground–target reflection versus range. As a result, selecting preset GAIN generally creates the desired mapping display. However, the pilot can control the gain manually (by selecting manual gain and rotating the GAIN control) to help achieve an optimum display.

With experience, the pilot can interpret the color display patterns that indicate water regions, coast lines, hilly or mountainous regions, cities, or even large structures. A good learning method is to practice ground–mapping during flights in clear visibility where the radar display can be visually compared with the terrain.

## Test Mode

The PRIMUS® 660 Digital Weather Radar System has a self-test mode and a maintenance function.

In the self-test (TST) mode a special test pattern is displayed as illustrated earlier in this section. The functions of this pattern are as follows:

- **Color Bands** – A series of black/green/yellow/red/cyan/white/magenta/blue bands, indicate that the signal to color conversion circuits are operating normally.

The maintenance function lets the pilot or the line maintenance technician determine the major fault areas. The fault data can be displayed in one of two ways (selected at the time of installation):

- TEXT FAULT – A plain English text indicating the failure is placed in the test band
- FAULT CODE – A fault code is displayed, refer to the maintenance manual for an explanation.

The indicator or EFIS display indicates a fault as noted below.

- **Dedicated Radar Indicator** – A FAIL annunciation is shown at the top left corner of the test pattern. It indicates that the built-in test equipment (BITE) circuitry is detecting a malfunction. The exact nature of the malfunction can be seen by selecting TEST. (Refer to Section 8, In-Flight Troubleshooting.)
- **EFIS/MFD/ND** –Faults are normally shown when test is selected.

- NOTES:**
1. Some weather failures on EFIS are annunciated with an amber WX.
  2. Some EFIS installations can power up with an amber WX if weather radar is turned off.
  3. If the fault code option is selected, they are shown with the FAIL annunciation (e.g., FAIL 13).

## 5. Radar Facts

### RADAR OPERATION

The PRIMUS<sup>®</sup> 660 Digital Weather Radar works on an echo principle. The radar sends out short bursts of electromagnetic energy that travel through space as a radio wave. When the traveling wave of energy strikes a target, some of the energy reflects back to the radar receiver. Electronic circuits measure the elapsed time between the transmission and the reception of the echo to determine the distance to the target (range). Because the antenna beam is scanning right and left in synchronism with the sectoring sweep on the indicator, the bearing of the target is found, as shown in figure 5-1.

The indicator with the radar is called a plan-position indicator (PPI) type. When an architect makes a drawing for a house, one of the views he generally shows is a plan view, a diagram of the house as viewed from above. The PPI aboard an airplane presents a cross sectional picture of the storm as though viewed from above. In short, it is NOT a horizon view of the storm cells ahead but rather a MAP view. This positional relationship of the airplane and the storm cells, as displayed by the indicator, is shown in figure 5-1.

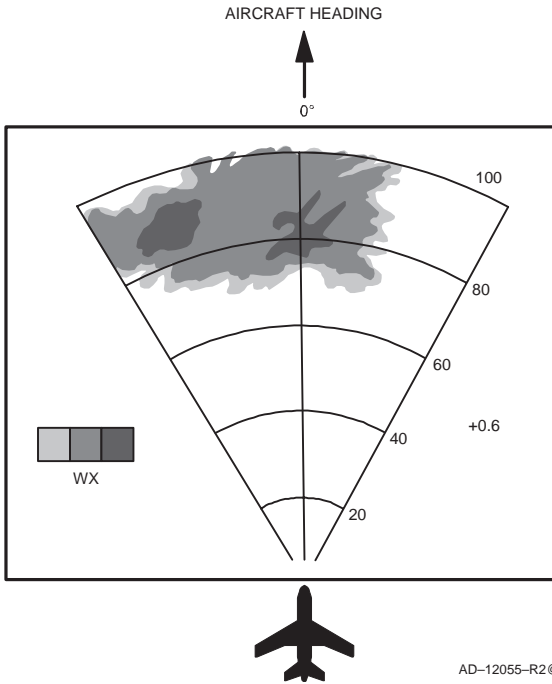

**Positional Relationship of an Airplane and Storm Cells Ahead as Displayed on Indicator**  
**Figure 5-1**

The drawing is laid out to simulate the face of the indicator with the semicircular range marks. To derive a clearer concept of the picture that the indicator presents, imagine that the storm is a loaf of sliced bread standing on end. From a point close to the surface of earth, it towers to a high-altitude summit. Without upsetting the loaf of bread, the radar removes a single slice from the middle of the loaf, and places this slice flat upon the table. Looking at the slice of bread from directly above, a cross section of the loaf can be seen in its broadest dimension. In the same manner, the radar beam literally slices out a horizontal cross section of the storm and displays it as though the viewer was looking at it from above, as shown in figure 5-2. The height of the slice selected for display depends upon the altitude and also upon the upward or downward TILT adjustment made to the antenna.



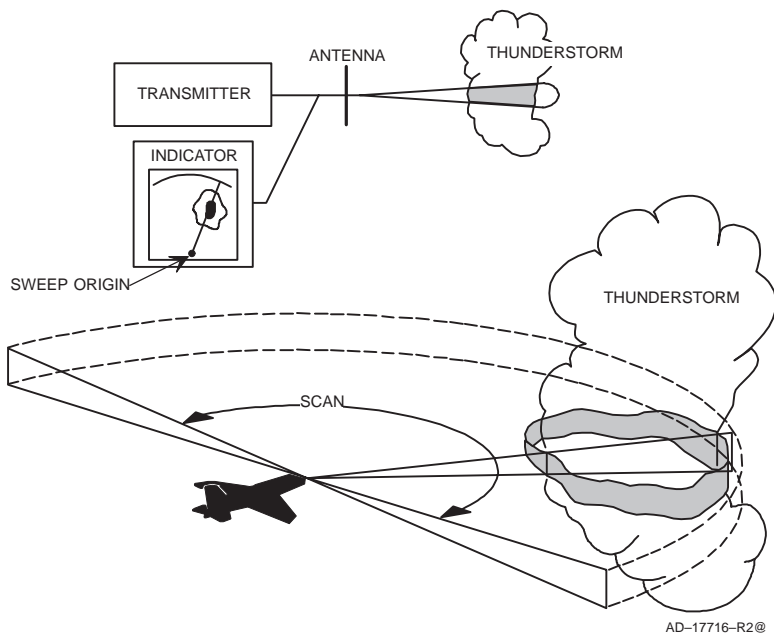

AD-17716-R2@

**Antenna Beam Slicing Out Cross Section of Storm  
During Horizontal Scan  
Figure 5-2**

Weather radar can occasionally detect other aircraft, but it is not designed for this purpose and should never be considered a collision-avoidance device. Nor is weather radar specifically designed as a navigational aid, but it can be used for ground mapping by tilting the antenna downward. Selecting the GMAP mode enhances returns from ground targets.

When the antenna is tilted downward for ground mapping, two phenomena can occur that can confuse the pilot. The first is called "The Great Plains Quadrant Effect" that is seen most often when flying over the great plains of central United States. In this region, property lines (fences), roads, houses, barns, and power lines tend to be laid out in a stringent north-south/east-west orientation. As a result, radar returns from these cardinal points of the compass tend to be more intense than returns from other directions and the display shows these returns as bright north/south/east/west spokes overlaying the ground map.

The second phenomenon is associated with radar returns from water surfaces (generally called sea clutter), as shown in figure 5-3. Calm water reflects very low radar returns since it directs the radar pulses onward instead of backward (i.e. the angle of incidence from mirrored light shone on it at an angle). The same is true when viewing choppy water from the upwind side. The downwind side of waves, however, can reflect a strong signal because of the steeper wave slope. A relatively bright patch of sea return, therefore, indicates the direction of surface winds.

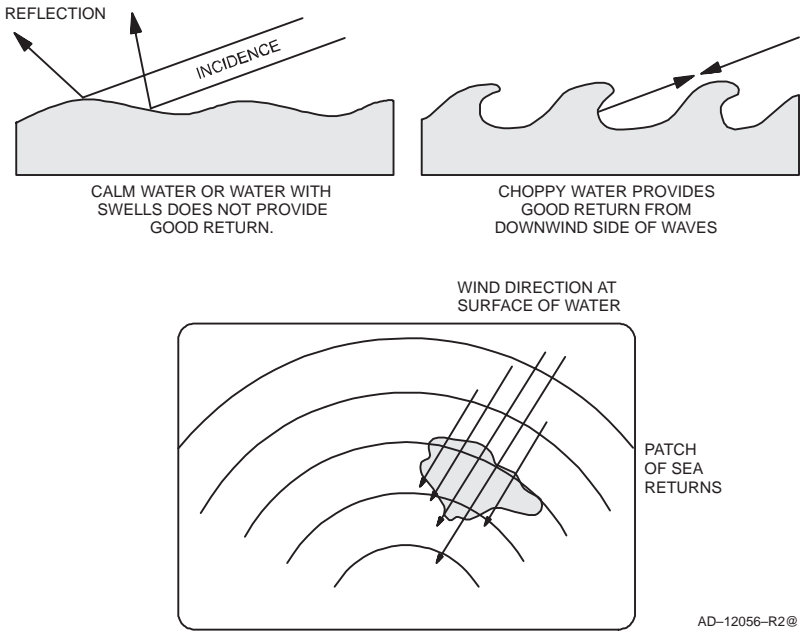

**Sea Returns**  
**Figure 5-3**

AD-12056-R2@

## TILT MANAGEMENT

The pilot can use tilt management techniques to minimize ground clutter when viewing weather targets.

Assume the aircraft is flying over relatively smooth terrain that is equivalent to sea level in altitude. The pilot must make adjustments for the effects of mountainous terrain.

The figures below help to visualize the relationship between tilt angle, flight altitude, and selected range. Figures 5-4 and 5-5 show the distance above and below aircraft altitude that is illuminated by the flat-plate radiator during level flight with 0° tilt. Figures 5-6 and 5-7 show a representative low altitude situation, with the antenna adjusted for 2.8° up-tilt.

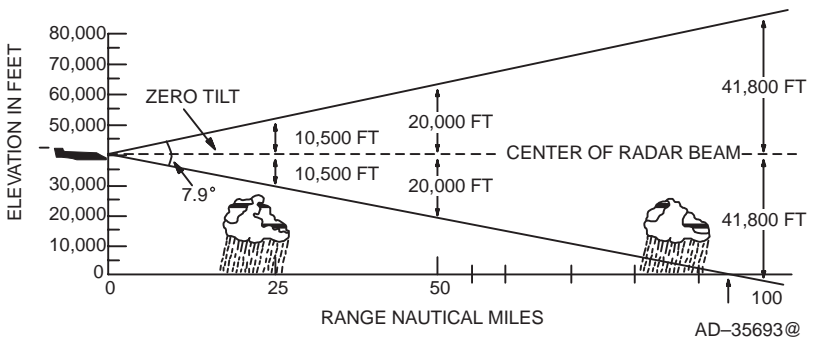

**Radar Beam Illumination High Altitude  
12-Inch Radiator  
Figure 5-4**

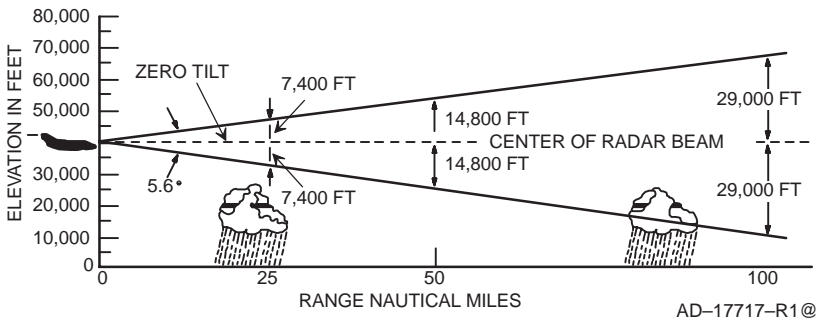

**Radar Beam Illumination High Altitude  
18-Inch Radiator  
Figure 5-5**

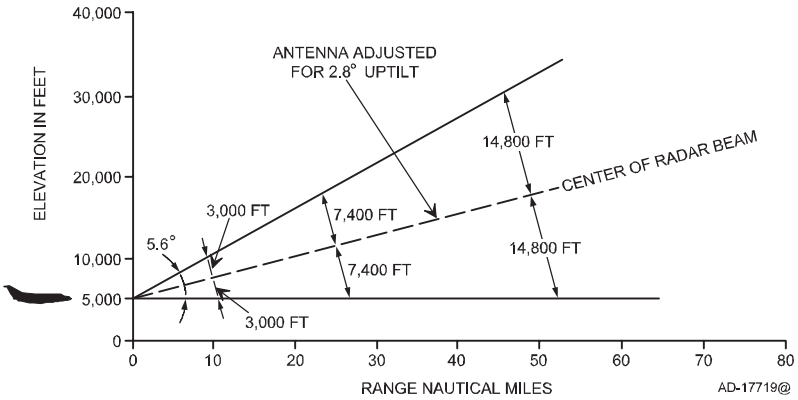

**Radar Beam Illumination Low Altitude  
12-Inch Radiator  
Figure 5-6**

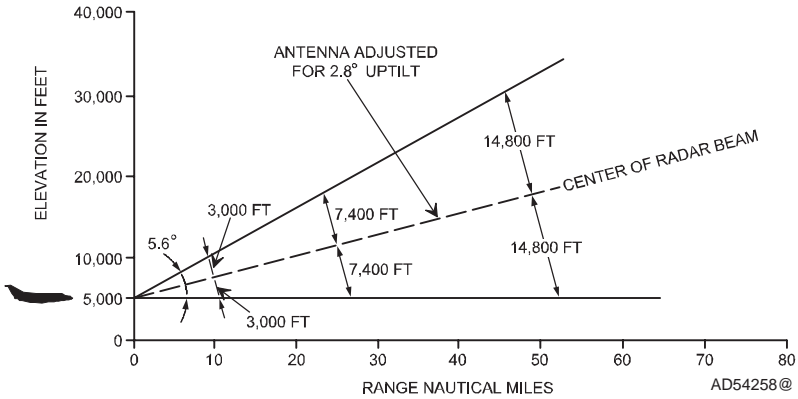

**Radar Beam Illumination Low Altitude  
18-Inch Radiator  
Figure 5-7**

Tables 5–1 and 5–2 give the approximate tilt settings that the ground targets begin to be displayed on the image periphery for 12– and 18–inch radiators. The range that the ground targets can be observed is affected by the curvature of the earth, the distance from the aircraft to the horizon, and altitude above the ground. As the tilt control is rotated downward, ground targets first appear on the display at less than maximum range.

To find the ideal tilt angle after the aircraft is airborne, adjust the TILT control so that groundclutter does not interfere with viewing of weather targets. Usually, this can be done by tilting the antenna downward in 1° increments until ground targets begin to appear at the display periphery. Ground returns can be distinguished from strong storm cells by watching for closer ground targets with each small downward increment of tilt. The more the downward tilt, the closer the ground targets that are displayed.

When ground targets are displayed, move the tilt angle upward in 1° increments until the ground targets begin to disappear. Proper tilt adjustment is a pilot judgment, but typically the best tilt angle lies where ground targets are barely visible or just off the radar image.

Tables 5–1 and 5–2 give the approximate tilt settings required for different altitudes and ranges. If the altitude changes or a different range is selected, adjust the tilt control as required to minimize ground returns.

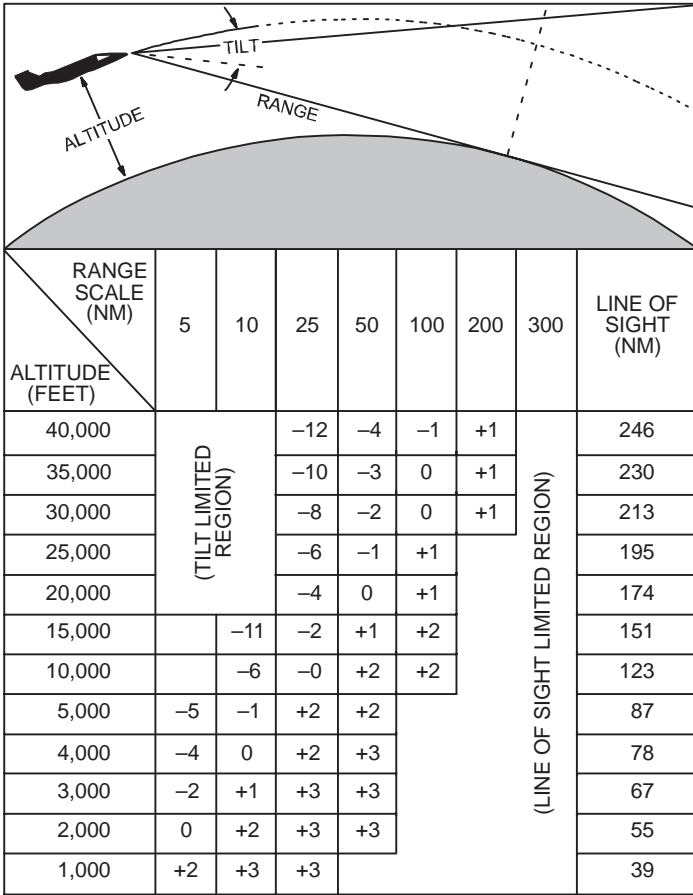

AD-29830-R2@

**Approximate Tilt Setting for Minimal Ground Target Display  
12-Inch Radiator  
Table 5-1**

Tilt angles shown are approximate. Where the tilt angle is not listed, the operator must exercise good judgment.

**NOTE:** The line of sight distance is nominal. Atmospheric conditions and terrain offset this value.

ALTITUDE (FEET)	RANGE SCALE (MILES)						LINE OF SIGHT (MILES)	
	5	10	25	50	100	200		
40,000	(TILT LIMITED REGION)		-13	-5	-2	-1	246	
35,000			-11	-4	-1	0	230	
30,000			-9	-3	-1	0	213	
25,000			-7	-2	0	(LINE OF SIGHT LIMITED REGION)	195	
20,000			-5	-1	0		174	
15,000			-12	-3	-1		+1	151
10,000			-7	-1	0		+1	123
5,000	-7	-2	0	+1	87			
4,000	-5	-1	+1	+2	78			
3,000	-3	0	+1	+2	67			
2,000	-1	+1	+2	+2	55			
1,000	+1	+2	+2		39			

AD-35711 @

**Approximate Tilt Setting for Minimal Ground Target Display  
18-Inch Radiator  
Table 5-2**

Tilt angles shown are approximate. Where the tilt angle is not listed, the operator must exercise good judgment.

**NOTE:** The line of sight distance is nominal. Atmospheric conditions and terrain offset this value.

Tilt management is often misunderstood. It is crucial to safe operation of airborne weather radar. If radar tilt angles are not properly managed, weather targets can be missed or underestimated.

The upper levels of convective storms are the most dangerous because of the probability of violent windshears and large hail. But hail and windshear are not very reflective because they lack reflective liquid water.

The figures that follow show the relationship between flight situations and the correct tilt angle. The first describes a high altitude situation; the second describes a low altitude situation.

- The ideal tilt angle shows a few ground targets at the edge of the display as shown in see figure 5–8.

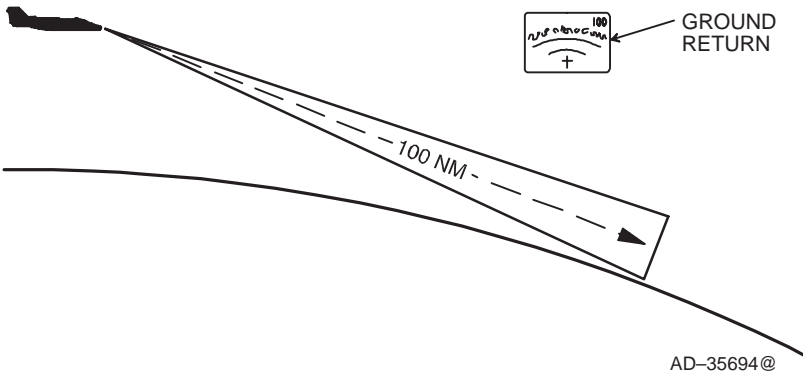

**Ideal Tilt Angle**  
**Figure 5–8**

- Earth's curvature can be a factor if altitude is low enough, or if the selected range is long enough, as shown in figure 5–9.

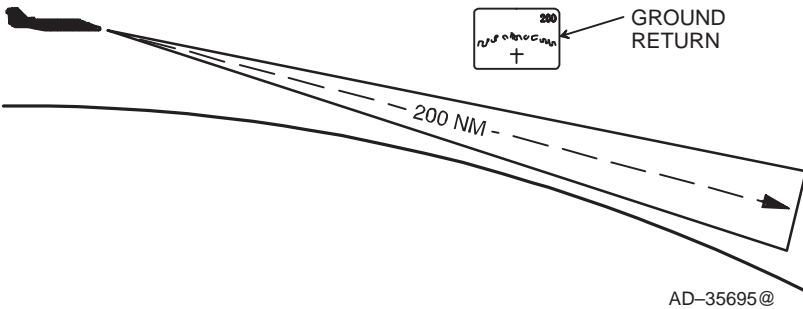

**Earth's Curvature**  
**Figure 5–9**



- Convective thunderstorms become much less reflective above the freezing level. This reflectivity decreases gradually over the first 5000 to 10,000 feet above the freezing level, as shown in figure 5-10.

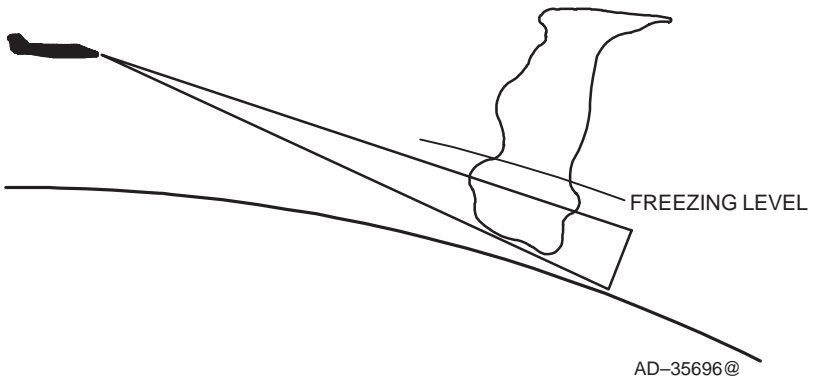

**Convective Thunderstorms  
Figure 5-10**

The aircraft in figure 5-10 has a clear radar indication of the thunderstorm, probably with a shadow in the ground returns behind it.

- If the tilt angle shown in figure 5-11 is not altered, the thunderstorm appears to weaken as the aircraft approaches it.

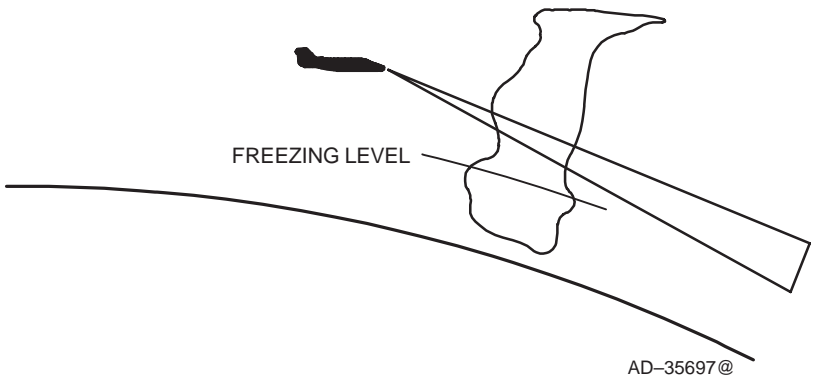

**Unaltered Tilt  
Figure 5-11**

- Proper tilt management demands that tilt be changed continually when approaching hazardous weather so that ground targets are not painted by the radar beam, as shown in figure 5–12.

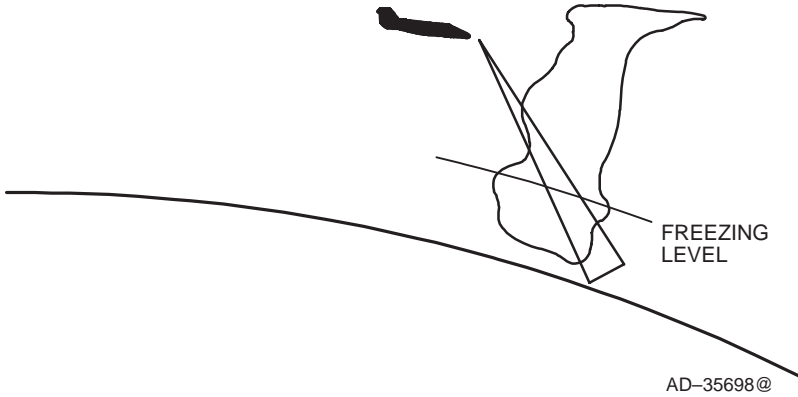

**Proper Tilt Technique**  
**Figure 5–12**

- After heading changes in a foul weather situation, the pilot should adjust the tilt to see what was brought into the aircraft's flightpath by the heading changes, as shown in figure 5–13.

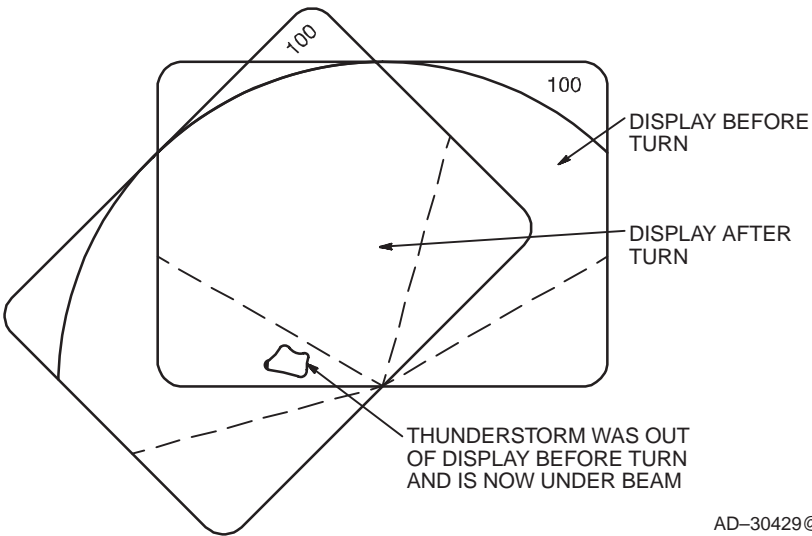

**Tilt Management With Heading Changes**  
**Figure 5–13**

- Under the right conditions, a dangerous thunder bumper can develop in 10 minutes, and can in fact spawn and mature under the radar beam as the aircraft approaches it, as shown in figure 5–14.

If flying at 400 kt groundspeed (GSPD), a fast developing thunderstorm that spawns 67 NM in front of the aircraft can be large enough to damage the aircraft by the time it arrives at the storm.

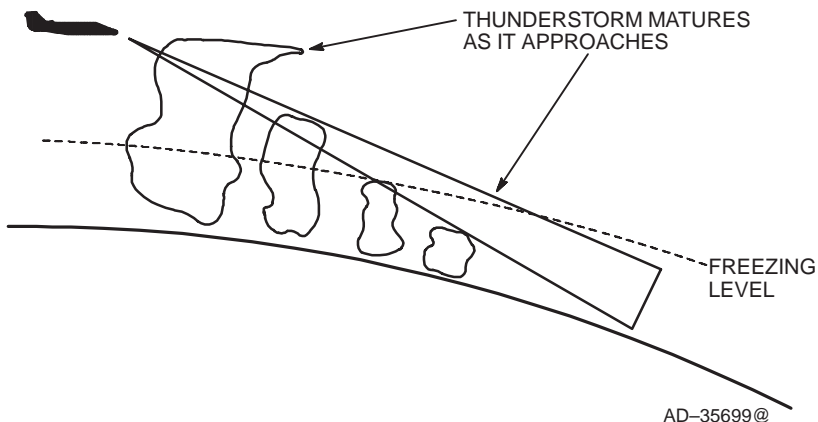

**Fast Developing Thunderstorm**  
Figure 5–14

- At low altitude, the tilt should be set as low as possible to get ground returns at the periphery only, as shown in figure 5–15.

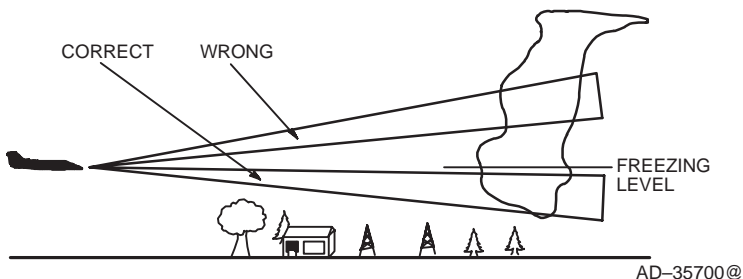

**Low Altitude Tilt Management**  
Figure 5–15

Excess up-tilt should be avoided as it can illuminate weather above the freezing level.

**NOTE:** The pilot should have freeze level information as a part of the flight planning process.

- The antenna size used on the aircraft alters the best tilt settings by about 1°. However, tilt management is the same for either size, as shown in figure 5–16.

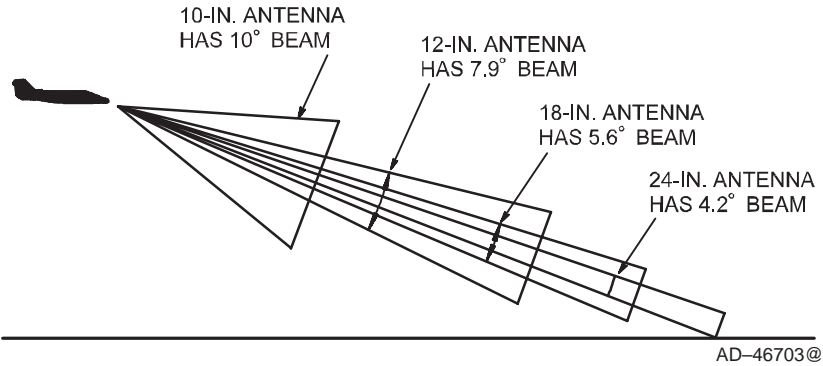

**Antenna Size and Impact on Tilt Management**  
**Figure 5–16**

**NOTE:** The 10– and 24–inch antennas are shown for illustration purposes only.

- Some of the rules of thumb are described below and shown in figure 5–17.
  - A 1° look down angle looks down 100 ft per mile.
  - Bottom of beam is 1/2 beam width below tilt setting.
  - A 12–inch antenna grazes the ground at 100 NM if set to 0° tilt at 40,000 ft.

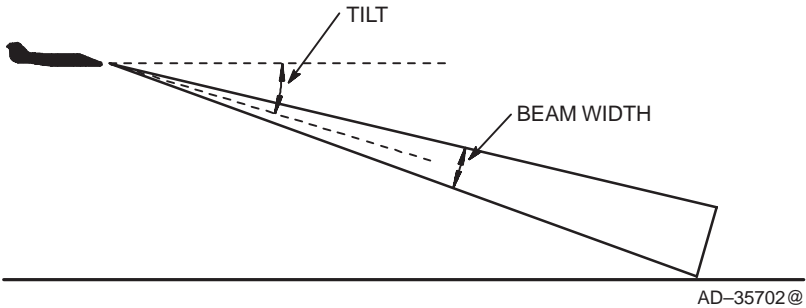

**Rules of Thumb**  
**Figure 5–17**

## STABILIZATION

The purpose of the stabilization system is to hold the elevation of the antenna beam relative to the earth's surface constant at all azimuths, regardless of aircraft bank and pitch maneuvers. The stabilization system uses the aircraft attitude source as a reference.

Several sources of error exist in any stabilization system.

### Dynamic Error

Dynamic error is the basis of the stabilization system. Stabilization is a corrective process. It logically follows that there must first be some error to correct. In stabilization, this error is called dynamic. An example of dynamic error occurs when a gust lifts the right wing and the pilot instinctively raises the right aileron and lowers the left. In this action, the pilot detects a changing (dynamic) error in aircraft attitude and corrects it.

As the gust lifts the wing, the aircraft attitude source sends a continuous stream of attitude change information to stabilization circuits that, in turn, control the motors that raise and lower the beam. In short, a dynamic error in aircraft attitude (as seen by the radar) is detected, and the antenna attitude is corrected for it. Extremely small errors of less than 1° can be detected and compensated. However, the point is ultimately reached where dynamic error is too small to be detected. Without detection, there is no compensation.

### Accelerative Error

One of the most common forms of error seen in a radar-antenna stabilization system results from forces of acceleration on the aircraft equipped with a vertical gyroscope. Acceleration forces result from speeding up, slowing down, or turning. Radar stabilization accuracy depends upon the aircraft vertical gyroscope. Therefore, any gyroscopic errors accumulated through acceleration are automatically imparted to the antenna stabilization system.

**NOTE:** LASEREF® vertical reference systems do not suffer from these acceleration effects.

A vertical gyroscope contains a gravity-sensitive element, a heavily dampened pendulous device that enables the gyro to erect itself to earth gravity at the rate of approximately  $2^\circ/\text{min}$ . The pendulous device is unable to differentiate between earth gravity and an acceleration force. It tends to rest at a false-gravity position where the forces of gravity and acceleration are equal. As long as the acceleration force persists, the gyroscope precesses toward a false-gravity position at the rate of approximately  $2^\circ/\text{min}$ . The radar follows the gyroscope into error at the same rate. When the acceleration force ceases, the gyroscope precesses back to true gravity erection at the same rate.

Some vertical gyroscopes have provisions for deactivating the roll-erection torque motor (whenever the airplane banks more than approximately  $6^\circ$ ) to reduce the effect of lateral acceleration during turns. To some extent, stabilization error is displayed in the radar image after any speed change and/or turn condition. If the stabilization system seems to be in error because the radar begins ground mapping on one side and not the other, or because it appears that the tilt adjustment has slipped, verify that aircraft has been in nonturning, constant-speed flight long enough to let the gyroscope erect on true earth gravity.

When dynamic and acceleration errors are taken into account, maintaining accuracy of  $1/2$  of  $1^\circ$  or less is not always possible. Adjust the antenna tilt by visually observing the ground return. Then, slowly tilt the antenna upward until terrain clutter no longer enters the display, except at the extreme edges.

## Antenna Mounting Error

If the radar consistently displays more ground returns on one side or the other during level flight over level ground, the antenna is probably scanning on a slight diagonal, rather than level with the earth. The usual cause is that the radar antenna is physically mounted slightly rotated from the vertical axis of the aircraft. The procedure in table 5-3 and figures 5-18, 5-19, and 5-20 can help you identify this type of problem.

On a vertical gyro equipped aircraft, the condition could be caused by mistrim flying one wing low. The gyro erects to this condition and the stabilization is not able to compensate.

## LEVEL FLIGHT STABILIZATION CHECK

Check stabilization in level flight using the procedure in table 5–3.

Step	Procedure
1	Trim the aircraft for straight and level flight in smooth, clear air over level terrain.
2	Select the 50-mile range.
3	Rotate the tilt control until a band of ground returns starts at the 40 NM range arc.
4	After several antenna sweeps, verify that ground returns are equally displayed (figure 5–18). If returns are only on one side of the radar screen or uneven across the radar screen, a misalignment of the radar antenna mounting is indicated.

**Stabilization in Straight and Level Flight Check Procedure**  
**Table 5–3**

**NOTE:** Refer to Section 7, In-Flight Adjustments, for procedures to adjust pitch and roll offsets.

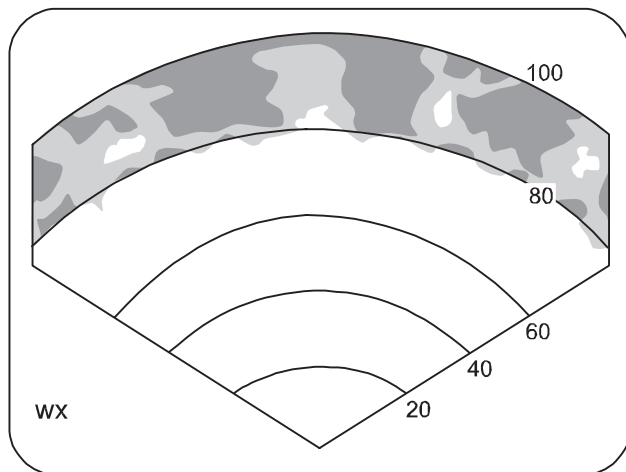

AD-17720-R3@

**Symmetrical Ground Returns**  
**Figure 5–18**

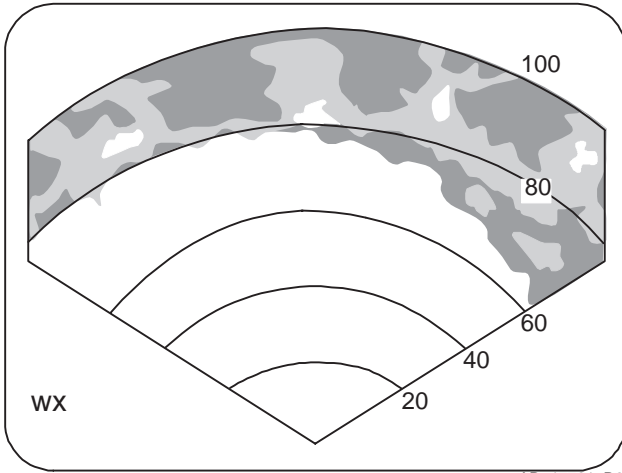

AD-17721-R2@

**Ground Return Indicating Misalignment (Upper Right)**  
**Figure 5-19**

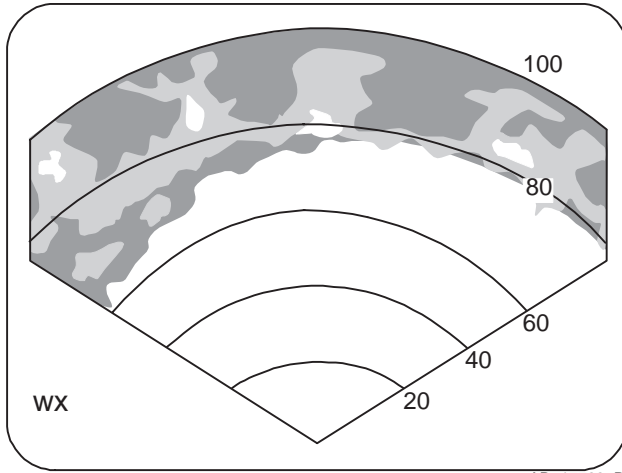

AD-17722-R2@

**Ground Return Indicating Misalignment (Upper Left)**  
**Figure 5-20**



## Wallowing (Wing Walk and Yaw) Error

A condition where the greatest intensity of ground targets wanders around the screen over a period of several minutes should not be confused with antenna mounting error. This phenomenon is caused by the tendency for many aircraft to slowly wallow (roll and yaw axes movement) with a cycle time of several minutes. The erection circuits of the gyro chasing the wallow can intensify the effect of wandering ground targets. IRS-equipped aircraft are less likely to show this condition.

## Roll Gain Error

If, when the aircraft is in a turn, you see ground returns on one side or the other that are not present in level flight, the roll gain is most likely misadjusted. The procedure in table 5-4, and figures 5-21, 5-22, and 5-23 can help you identify this type of problem. Figure 5-24 shows a total lack of roll stabilization in a turn.

### ROLL STABILIZATION (WHILE TURNING) CHECK

Once proper operation is established in level flight, verify stabilization in a turn using this procedure.

Step	Procedure
1	Place the aircraft in 20° roll to the right.
2	Note the radar display. It should contain appreciably no more returns than found during level flight. See figure 5-24.
3	If returns display on the right side of radar indicator; the radar system is understabilizing.
4	Targets on the left side of the radar display indicate the system is overstabilizing. See figure 5-23.
<p><b>NOTE:</b> Proper radar operation in turns depends on the accuracy and stability of the installed attitude source.</p>	

**Stabilization in Turns Check Procedure**  
**Table 5-4**

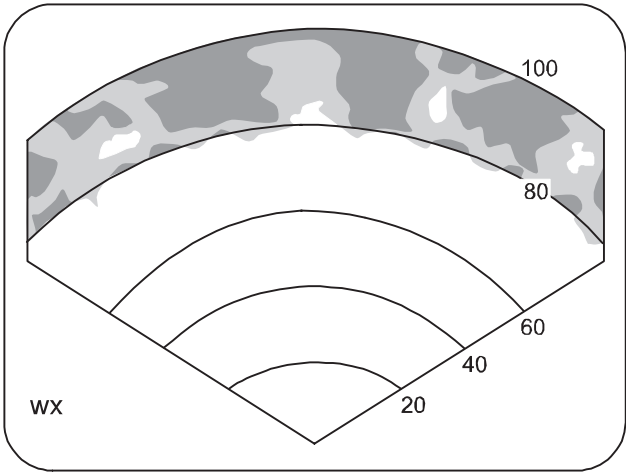

AD-17720-R3@

**Symmetrical Ground Returns – Good Roll Stabilization**  
**Figure 5-21**

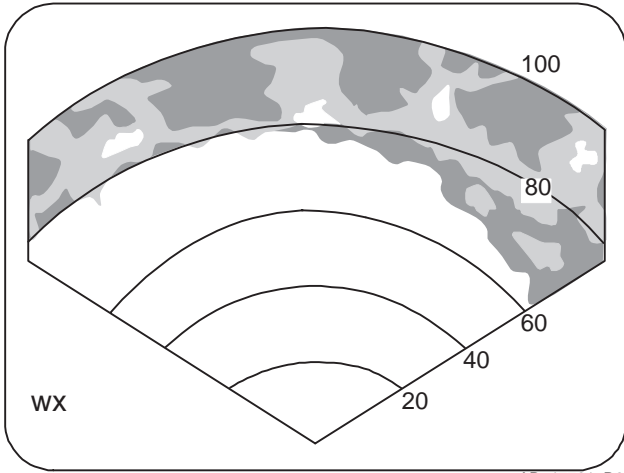

AD-17721-R2@

**Understabilization in a Right Turn**  
**Figure 5-22**

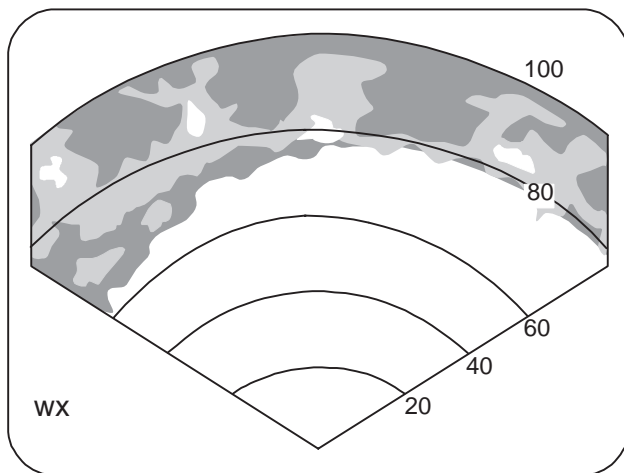

AD-17722-R2@

**Overstabilization in a Right Turn**  
**Figure 5-23**

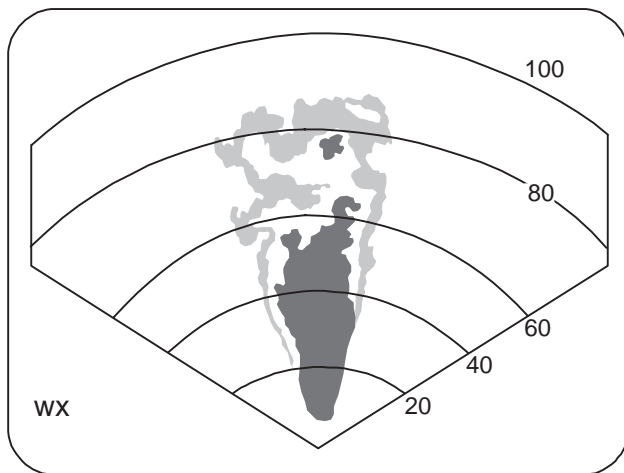

AD-17723-R2@

**Roll Stabilization Inoperative in a Turn**  
**Figure 5-24**

## Pitch Gain Error

If the aircraft is in a pitch maneuver and you see ground returns that are not present in level flight, the pitch gain is most likely misadjusted. The procedure in table 5–5 and figures 5–25, 5–26, and 5–27 can help you identify this type of problem.

### PITCH STABILIZATION CHECK

Once proper operation of the roll stabilization is established, verify pitch stabilization using the procedure in table 5–5 and figures 5–25, 5–26, and 5–27.

Step	Procedure
1	Complete the steps listed in table 5–3.
2	Place the aircraft between 5 and 10° pitch up.
3	Note the radar display. If it is correctly stabilized, there is very little change in the ground returns.
4	If the display of ground returns resembles figure 5–26, the radar is understabilized.
5	If the display of ground returns resembles figure 5–27, the radar is overstabilized.

**Pitch Stabilization In-Flight Check Procedure**  
**Table 5–5**

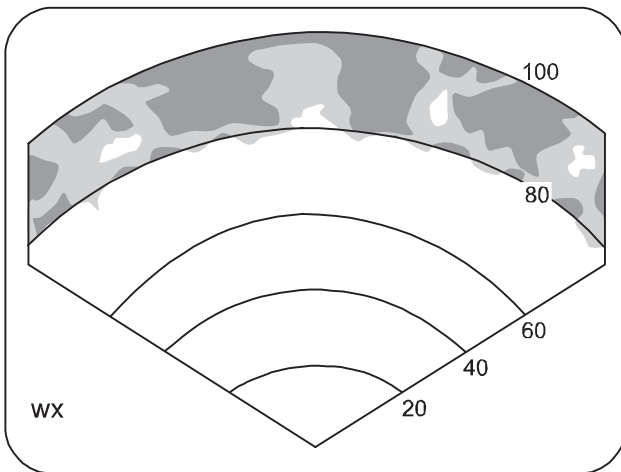

AD-17720-R3@

**Symmetrical Ground Returns – Good Pitch Stabilization**  
**Figure 5–25**

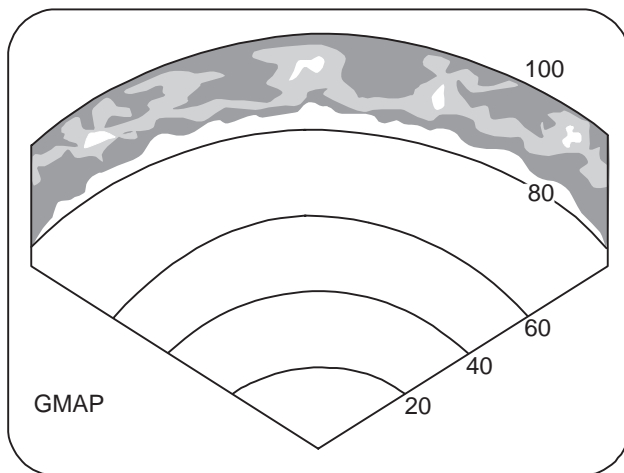

AD-53797@

**Understabilized in Pitch-Up  
Figure 5-26**

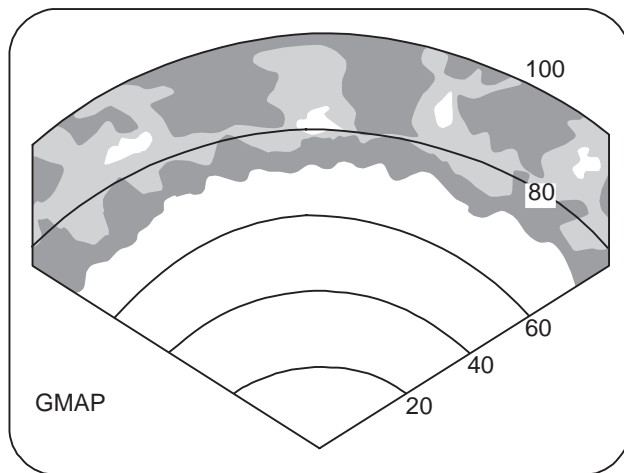

AD-53798@

**Overstabilized in Pitch-Up  
Figure 5-27**

Refer to Section 7, In-Flight Adjustments, for adjustment procedures.

## INTERPRETING WEATHER RADAR IMAGES

From a weather standpoint, hail and turbulence are the principal obstacles to a safe and comfortable flight. Neither of these conditions is directly visible on radar. The radar shows only the rainfall patterns that these conditions are associated.

The weather radar can see water best in its liquid form, as shown in figure 5–28 (not water vapor; not ice crystals; not hail when small and perfectly dry). It can see rain, wet snow, wet hail, and dry hail when its diameter is about 8/10 of the radar wavelength or larger. (At X–band, this means that dry hail becomes visible to the radar at about 1–in. diameter.)

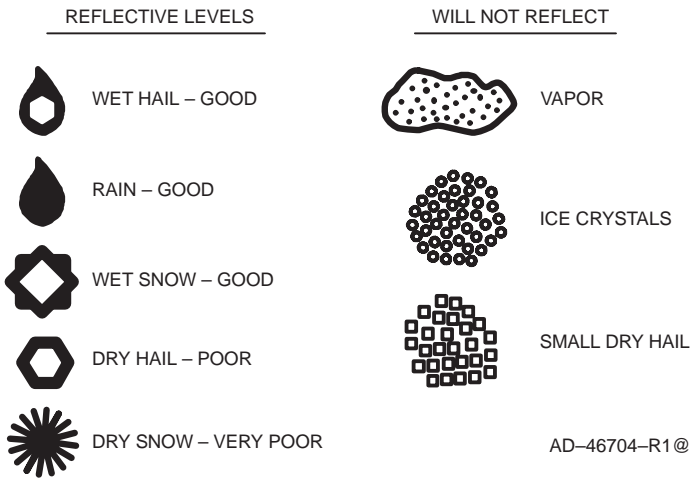

AD-46704-R1@

**Weather Radar Images  
Figure 5–28**

The following are some truths about weather and flying, as shown in figure 5–29.

- Turbulence results when two air masses at different temperatures and/or pressures meet.
- This meeting can form a thunderstorm.
- The thunderstorm produces rain.
- The radar displays rain (thus revealing the turbulence).
- In the thunderstorm's cumulus stage, echoes appear on the display and grow progressively larger and sharper. The antenna can be tilted up and down in small increments to maximize the echo pattern.
- In the thunderstorm's mature stage, radar echoes are sharp and clear. Hail occurs most frequently early in this stage.
- In the thunderstorm's dissipating stage, the rain area is largest and shows best with a slight downward antenna tilt.

Radar can be used to look inside the precipitation area to spot zones of present and developing turbulence. Some knowledge of meteorology is required to identify these areas as being turbulent. The most important fact is that the areas of maximum turbulence occur where the most abrupt changes from light or no rain to heavy rain occur. The term applied to this change in rate is rain gradient. The greater the change in rainfall rate, the steeper the rain gradient. The steeper the rain gradient, the greater the accompanying turbulence. More important, however, is another fact: storm cells are not static or stable, but are in a constant state of change. While a single thunderstorm seldom lasts more than an hour, a squall line, shown in figure 5–30, can contain many such storm cells developing and decaying over a much longer period. A single cell can start as a cumulus cloud only 1 mile in diameter, rise to 15,000 ft, grow within 10 minutes to 5 miles in diameter and tower to an altitude of 60,000 feet or more. Therefore, weather radar should not be used to take flash pictures of weather, but to keep weather under continuous surveillance.

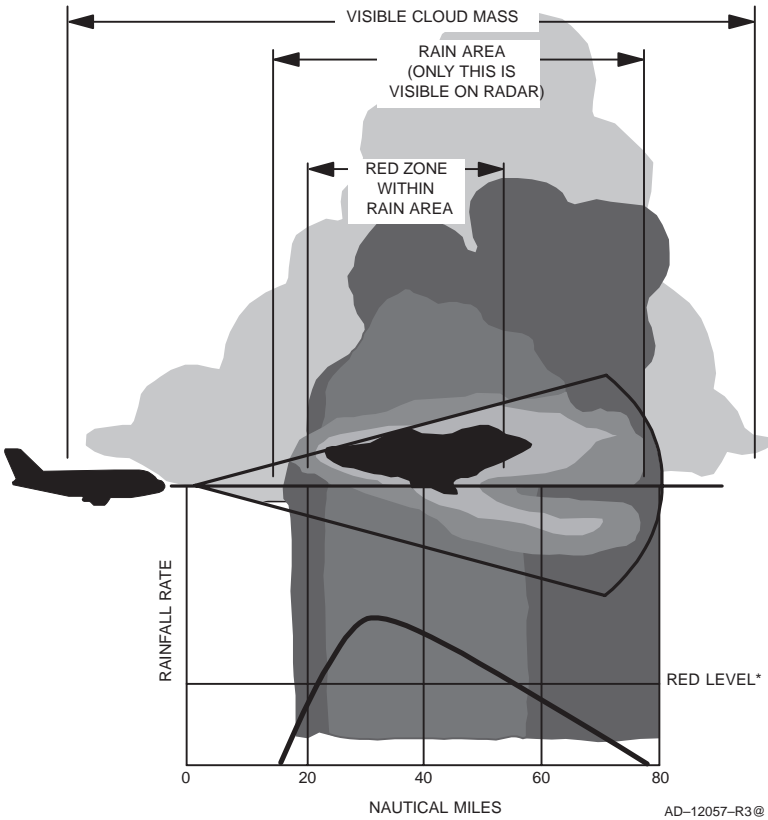

**Radar and Visual Cloud Mass  
Figure 5-29**

As masses of warm, moist air are hurled upward to meet the colder air above, the moisture condenses and builds into raindrops heavy enough to fall downward through the updraft. When this precipitation is heavy enough, it can reverse the updraft. Between these downdrafts (shafts of rain), updrafts continue at tremendous velocities. It is not surprising, therefore, that the areas of maximum turbulence are near these interfaces between updraft and downdraft. Keep these facts in mind when tempted to crowd a rain shaft or to fly over an innocent-looking cumulus cloud.



To find a safe and comfortable route through the precipitation area, study the radar image of the squall line while closing in on the thunderstorm area. In the example shown in figure 5–30, radar observation shows that the rainfall is steadily diminishing on the left while it is very heavy in two mature cells (and increasing rapidly in a third cell) to the right. The safest and most comfortable course lies to the left where the storm is decaying into a light rain. The growing cell on the right should be given a wide berth.

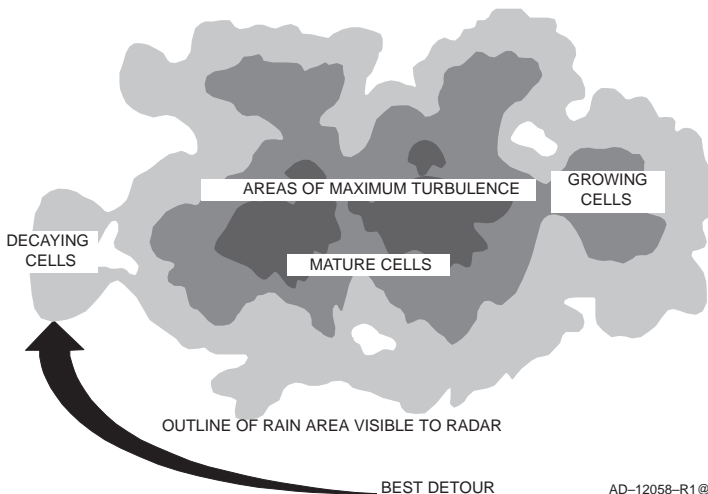

**Squall Line**  
**Figure 5–30**

## WEATHER DISPLAY CALIBRATION

Ground based Nexrad radars of the National Weather Service display rainfall levels in dBZ, a decibel scaling of an arbitrary reflectivity factor (Z). The formula for determining dBZ is:  $\text{dBZ} = 16 \log R + 23$ , where R is the rainfall rate in millimeters per hour. The Nexrad radar displays rainfall in 15 color coded levels of 5 dBZ per step.

There is a close correspondence in rainfall rates between the colors in the PRIMUS® airborne radars and color families in a Nexrad display. To help the pilot in comparing them, table 5–6 shows PRIMUS® radar colors, rainfall rates, and dBZ.

The dBZ rainfall intensity scale replaces the video integrated processor (VIP) intensity scale used in the previous generation ground based radars. Table 5–7 compares the classic VIP levels, rainfall rates, and storm categories with the new dBZ levels. Refer to Section 6 of FAA Advisory Circular AC–00–24B for additional information on VIP levels.

Table 5–6 also shows maximum calibrated range for each color level. This is the maximum range where the indicated rainfall rate can be detected if there is no intervening radar signal attenuation caused by other precipitation. Beyond calibrated range, the precipitation appears at a lower color level than it actually is. For example, (with a 12–inch antenna) a red level storm can appear as a green level at 200 miles, as you fly closer it becomes yellow, and then red at 130 miles. As covered in the RCT description, intervening rainfall reduces the calibrated range and the radar can incorrectly depict the true cell intensity.

The radar calibration includes a nominal allowance for radome losses. Excessive losses in the radome seriously affect radar calibration. One possible means of verification is signal returns from known ground targets. It is recommended that you report evidence of weak returns to ensure that radome performance is maintained at a level that does not affect radar calibration.

To test for a performance loss, note the distance that the aircraft's base city, a mountain, or a shoreline can be painted from a given altitude. When flying in familiar surroundings, verify that landmarks can still be painted at the same distances.

Any loss in performance results in the system not painting the reference target at the normal range.

300 NAUTICAL MILES						
DISPLAY LEVEL	RAINFALL RATE MM/HR	RAINFALL RATE IN./HR	dBZ	MAXIMUM CALIBRATE D RANGE (NM) 10-IN AND 12-IN FLAT-PLATE	MAXIMUM CALIBRATE D RANGE (NM) 18-IN FLAT-PLATE	MAXIMUM CALIBRATE D RANGE (NM) 24-IN FLAT-PLATE
4 (MAGENTA)	GREATER THAN 50	GREATER THAN 2	GREATER THAN 53	232	GREATER THAN 300	GREATER THAN 300
3 (RED)	12 – 50	0.5 – 2	40 – 53	130	190	230
2 (YELLOW)	4 – 12	0.17 – 0.5	33 – 40	90	130	160
1 (GREEN)	1 – 4	0.04 – 0.17	23 – 33	55	80	100
0 (BLACK)	LESS THAN 1	LESS THAN 0.04	LESS THAN 23	–	–	–

**Display Levels Related to dBZ Levels (Typical)**

**Table 5–6**

**WARNING**

**THE RADAR IS CALIBRATED FOR CONVECTIVE WEATHER. STRATIFORM STORMS AT OR NEAR THE FREEZING LEVEL CAN SHOW HIGH REFLECTIVITY. DO NOT PENETRATE SUCH TARGETS.**

VIP Level	Rainfall rate in mm/hr	Storm Category	dBZ Level
6	Greater than 125	Extreme	Greater than 57
5	50 – 125	Intense	50 – 57
4	25 – 50	Very Strong	45 – 50
3	12 – 25	Strong	40 – 45
2	2.5 – 12	Moderate	29 – 40
1	0.25 – 2.5	Weak	13 – 29

**VIP Levels Related to dBZ**  
**Table 5-7**

## VARIABLE GAIN CONTROL

The PRIMUS® 660 Digital Weather Radar variable gain control is a single turn rotary control and a push/pull switch that is used to control the radar’s receiver gain. With the switch pushed in, the system is in the preset, calibrated gain mode. In calibrated gain, the rotary control does nothing.

When the GAIN switch is pulled out, the system enters the variable gain mode. Variable gain is useful for additional weather analysis. In the WX mode, variable gain can increase receiver sensitivity over the calibrated level to show very weak targets or it can be reduced below the calibrated level to eliminate weak returns.

## WARNING

**LOW VARIABLE GAIN SETTINGS CAN ELIMINATE HAZARDOUS TARGETS.**

---

## RAIN ECHO ATTENUATION COMPENSATION TECHNIQUE (REACT)

Honeywell's REACT feature has three separate, but related functions.

- **Attenuation Compensation** – As the radar energy travels through rainfall, the raindrops reflect a portion of the energy back toward the airplane. This results in less energy being available to detect raindrops at greater ranges. This process continues throughout the depth of the storm, resulting in a phenomenon known as attenuation. The amount of attenuation increases with an increase in rainfall rate and with an increase in the range traveled through the rainfall (i.e., heavy rain over a large area results in high levels of attenuation, while light rain over a small area results in low levels of attenuation).

Storms with high rainfall rates can totally attenuate the radar energy making it impossible to see a second cell hidden behind the first cell. In some cases, attenuation can be so extreme that the total depth of a single cell cannot be shown.

Without some form of compensation, attenuation causes a single cell to appear to weaken as the depth of the cell increases.

Honeywell has incorporated attenuation compensation that adjusts the receiver gain by an amount equal to the amount of attenuation. That is, the greater the amount of attenuation, the higher the receiver gain and thus, the more sensitive the receiver. Attenuation compensation continuously calibrates the display of weather targets, regardless of the amount of attenuation.

With attenuation compensation, weather target calibration is maintained throughout the entire range of a single cell. The cell behind a cell remains properly calibrated, making proper calibration of weather targets at long ranges possible.

- **Cyan REACT Field** – From the description of attenuation, it can be seen that high levels of attenuation (caused by cells with heavy rainfall) causes the attenuation compensation circuitry to increase the receiver gain at a fast rate.

Low levels of attenuation (caused by cells with low rainfall rates) cause the receiver gain to increase at a slower rate.

The receiver gain is adjusted to maintain target calibration. Since there is a maximum limit to receiver gain, strong targets (high attenuation levels) cause the receiver to reach its maximum gain value in a short time/short range. Weak or no targets (low attenuation levels) cause the receiver to reach its maximum gain value in a longer time/longer range. Once the receiver reaches its maximum gain value, weather targets can no longer be calibrated. The point where red level weather target calibration is no longer possible is highlighted by changing the background field from black to cyan.

Any area of cyan background is an area where attenuation has caused the receiver gain to reach its maximum value, so further calibration of returns is not possible. Extreme caution is recommended in any attempt to analyze weather in these cyan areas. The radar cannot display an accurate picture of what is in these cyan areas. Cyan areas should be avoided.

**NOTE:** If the radar is operated such that ground targets are affecting REACT, they could cause REACT to give invalid indications.

Any target detected inside a cyan area is automatically forced to a magenta color indicating maximum severity. Figure 5–31 shows the same storm with REACT OFF and with REACT ON.

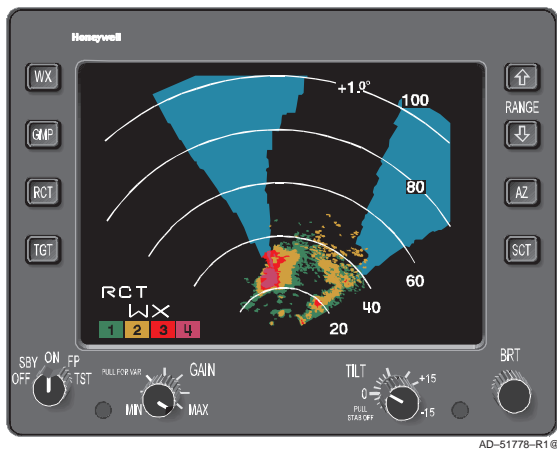

With REACT Selected

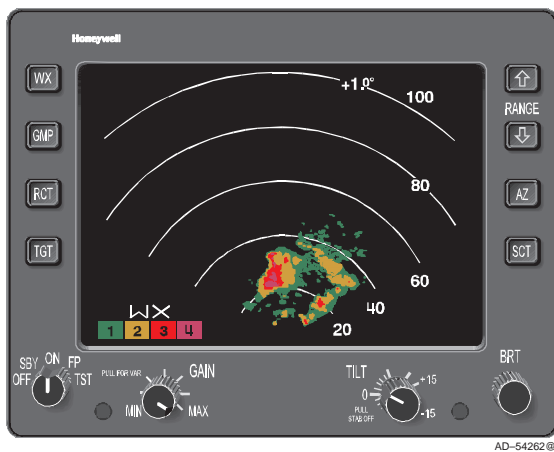

Without REACT

REACT ON and OFF Indications  
Figure 5-31

## Shadowing

An operating technique similar to the REACT blue field is shadowing. To use the shadowing technique, tilt the antenna down until ground is being painted just in front of the storm cell(s). An area of no ground returns behind the storm cell has the appearance of a shadow behind the cell. This shadow area indicates that the storm cell has totally attenuated the radar energy and the radar cannot show any additional targets (WX or ground) behind the cell. The cell that produces a radar shadow is a very strong and dangerous cell. It should be avoided by 20 miles.

### WARNING

**DO NOT FLY INTO THE SHADOW BEHIND THE CELL.**

## Turbulence Probability

The graph of turbulence probability is shown in figure 5–32. This graph shows the following:

- There is a 100% probability of light turbulence occurring in any area of rain
- A level one storm (all green) has virtually no chance of containing severe or extreme turbulence but has between a 5% and 20% chance that moderate turbulence exists
- A level two storm (one containing green and yellow returns) has virtually no probability of extreme turbulence but has a 20% to 40% chance of moderate turbulence and up to a 5% chance of severe turbulence
- A level three storm (green, yellow, and red radar returns) has a 40% to 85% chance of moderate turbulence, a 5% to 10% chance of severe turbulence, and a slight chance of extreme turbulence
- A level four storm (one with a magenta return) has moderate turbulence, a 10% to 50% chance of severe turbulence, and a slight to 25% chance of extreme turbulence.

### WARNING

**THE AREAS OF TURBULENCE CAN NOT BE ASSOCIATED WITH THE MAXIMUM RAINFALL AREAS. THE PROBABILITIES OF TURBULENCE ARE STATED FOR THE ENTIRE STORM AREA, NOT JUST THE HEAVY RAINFALL AREAS.**



Although penetrating a storm with a red (level three) core appears to be an acceptable risk, it is not. At the lower end of the red zone, there is no chance of extreme turbulence, a slight chance of severe turbulence, and a 40% chance of moderate turbulence. However, the radar lumps all of the rainfall rates between 12 mm to 50 mm per hour into one group – a level three (red). Once the rainfall rate reaches the red threshold, it masks any additional information about the rainfall rate until the magenta threshold is reached. A red return covers a range of turbulence probabilities and the worst case must be assumed, especially since extreme, destructive turbulence is born in the red zone. Therefore, once the red threshold is reached, the risk in penetration becomes totally unacceptable.

Likewise, once the magenta threshold is reached, it must be assumed that more severe weather is being masked.

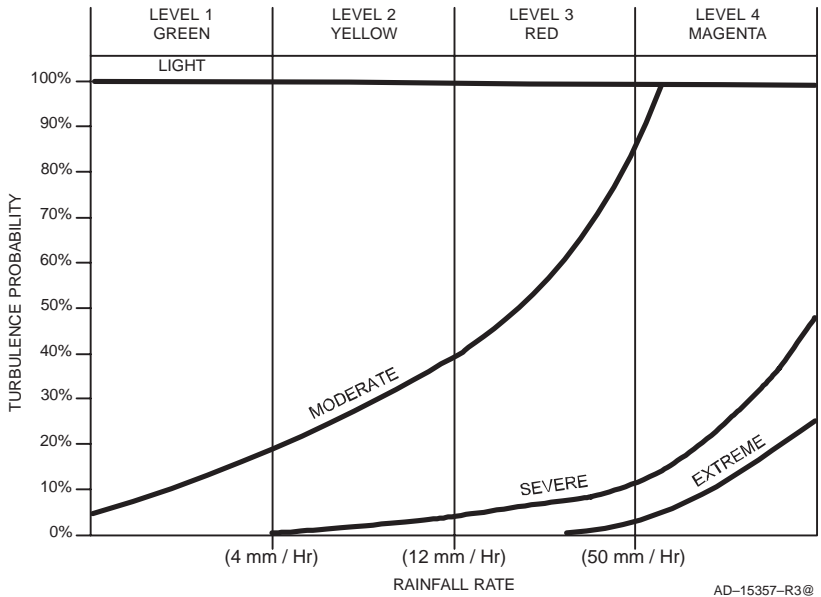

**Probability of Turbulence Presence  
in a Weather Target  
Figure 5-32**

Turbulence levels are listed and described in table 5–8.

INTENSITY	AIRCRAFT REACTION	REACTION INSIDE AIRCRAFT
LIGHT	Turbulence that momentarily causes slight, erratic changes in altitude and/or attitude (pitch, roll, yaw).	Occupants can feel a slight strain against seat belts or shoulder straps. Unsecured objects can be displaced slightly.
MODERATE	Turbulence that is similar to light turbulence but of greater intensity. Changes in altitude and/or attitude occur but the aircraft remains in positive control at all times. It usually causes variations in indicated airspeed.	Occupants feel definite strains against seat belts or shoulder straps. Unsecured objects are dislodged.
SEVERE	Turbulence that causes large abrupt changes in altitude and/or attitude. It usually causes large variations in indicated airspeed. Aircraft can be momentarily out of control.	Occupants are forced violently against seat belts or shoulder straps. Unsecured objects are tossed about.

**Turbulence Levels (From Airman’s Information Manual)  
Table 5–8**

## Hail Size Probability

Whenever the radar shows a red or magenta target, the entire storm cell should be considered extremely hazardous and must not be penetrated. Further support for this statement comes from the hail probability graph, shown in figure 5–33. The probability of destructive hail starts at a rainfall rate just above the red level three threshold.

Like precipitation, the red and magenta returns should be considered as a mask over more severe hail probabilities.

By now, it should be clear that the only safe way to operate in areas of thunderstorm activity is to **AVOID ALL CELLS THAT HAVE RED OR MAGENTA RETURNS.**

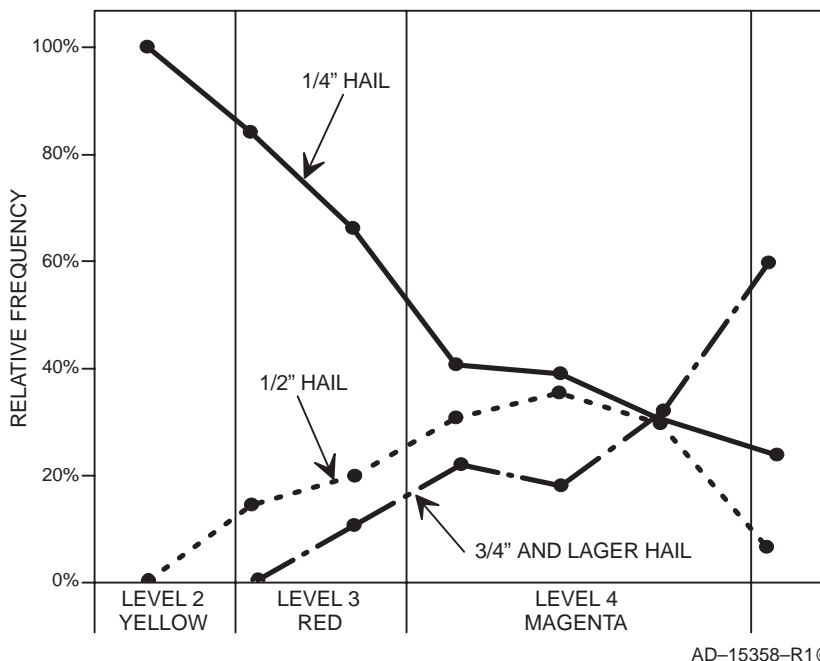

AD-15358-R1@

**Hail Size Probability**  
**Figure 5-33**

## Spotting Hail

As previously stated, dry hail is a poor reflector, and therefore generates deceptively weak or absent radar returns. When flying above the freezing level, hail can be expected in regions above and around wet storm cells found at lower altitudes. The hail is carried up to the tropopause by strong vertical winds inside the storm. In large storms, these winds can easily exceed 200 kt, making them very dangerous. Since the core of such a storm is very turbulent, but largely icy, the red core on the radar display is weak or absent and highly mobile. The storm core can be expected to change shapes with each antenna scan.

On reaching the tropopause, the hail is ejected from the storm and falls downward to a point where it is sucked back into the storm. When the hail falls below the freezing level, however, it begins to melt and form a thin surface layer of liquid detectable by radar. A slight downward tilt of the antenna toward the warmer air shows rain coming from unseen dry hail that is directly in the flightpath, as shown in figure 5-34. At lower altitudes, the reverse is sometimes true. The radar can be scanning below a rapidly developing storm cell, that the heavy rain droplets have not had time to fall through the updrafts to the flight level. Tilting the antenna up and down regularly produces the total weather picture.

Using a tilt setting that has the radar look into the area of maximum reflectivity (5000 to 20,000 ft) gives the strongest radar picture. However the tilt setting must not be left at this setting. Periodically, the pilot should look up and down from this setting to see the total picture of the weather in the flightpath.

Often, hailstorms generate weak but characteristic patterns like those shown in figure 5–35. Fingers or hooks of cyclonic winds that radiate from the main body of a storm usually contain hail. A U shaped pattern is also (frequently) a column of dry hail that returns no signal but is buried in a larger area of rain that does return a strong signal. Scalloped edges on a pattern also indicate the presence of dry hail bordering a rain area. Finally, weak or fuzzy protuberances are not always associated with hail, but should be watched closely; they can change rapidly.

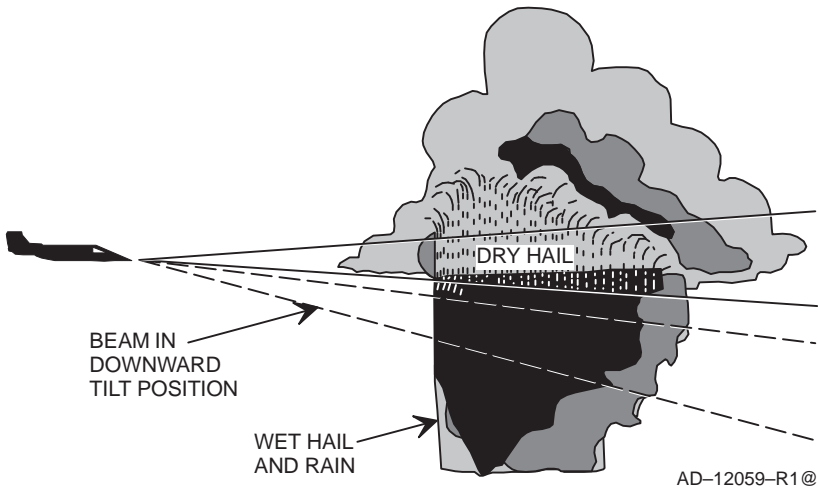

**Rain Coming From Unseen Dry Hail**  
**Figure 5–34**

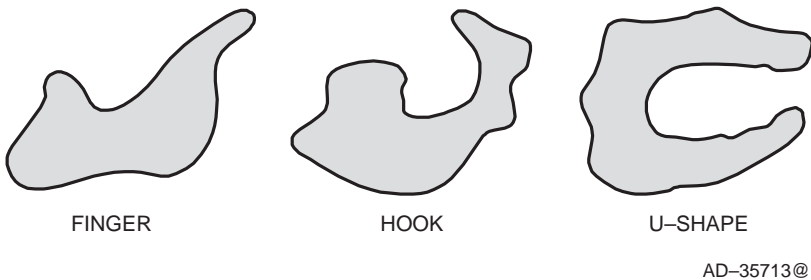

**Familiar Hailstorm Patterns**  
**Figure 5–35**

The more that is learned about radar, the more the pilot is an all-important part of the system. The proper use of controls is essential to gathering all pertinent weather data. The proper interpretation of that data (the displayed patterns) is equally important to safety and comfort.

This point is illustrated again in figure 5–36. When flying at higher altitudes, a storm detected on the long-range setting can disappear from the display as it is approached. The pilot should not be fooled into believing the storm has dissipated as the aircraft approaches it. The possibility exists that the radiated energy is being directed from the aircraft antenna above the storm as the aircraft gets closer. If this is the case, the weather shows up again when the antenna is tilted downward as little as 1°. Assuming that a storm has dissipated during the approach can be quite dangerous; if this is not the case, the turbulence above a storm can be as severe as that inside it.

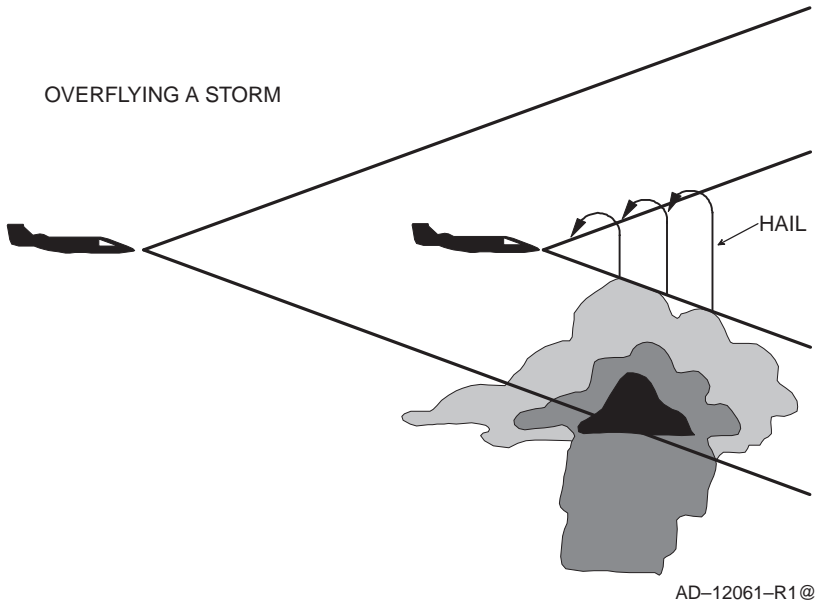

**Overshooting a Storm**  
**Figure 5–36**

Another example of the pilot's importance in helping the radar serve its safety/comfort purpose is shown in figure 5-37. This is the blind alley or box canyon situation. Pilots can find themselves in this situation if they habitually fly with the radar on the short range. The short-range returns show an obvious corridor between two areas of heavy rainfall, but the long-range setting shows the trap. Both the near and far weather zones could be avoided by a short-term course change of about 45° to the right. Always switch to long range before entering such a corridor.

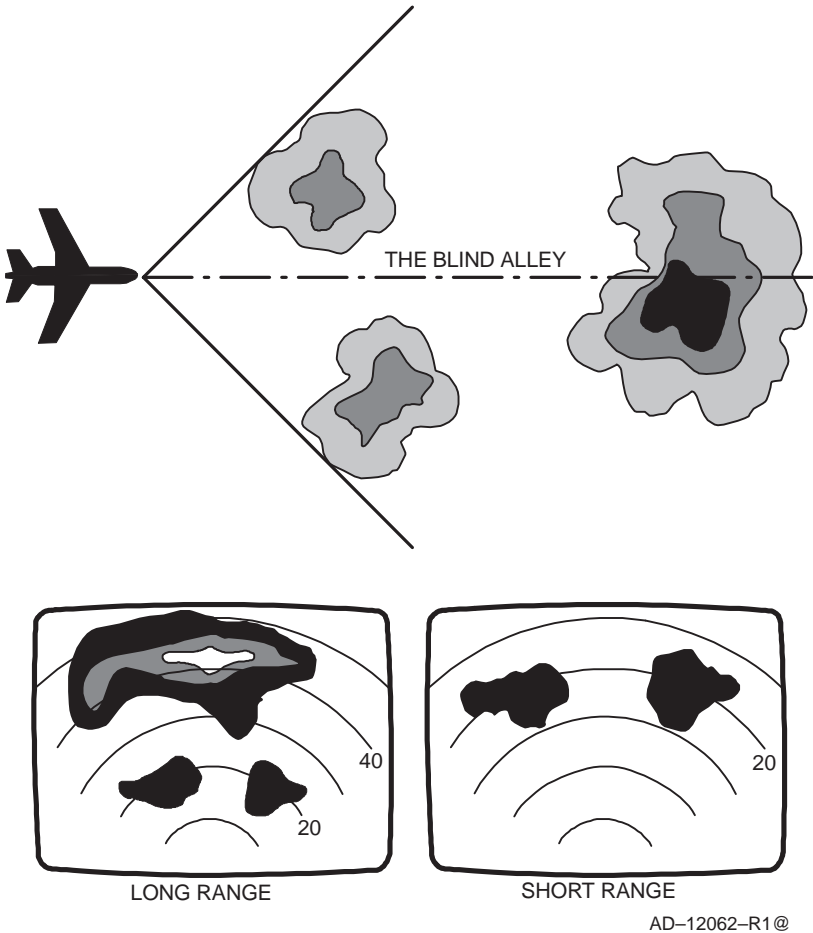

**Short- and Long-Blind Alley**  
**Figure 5-37**

## Azimuth Resolution

When two targets, such as storms, are closely adjacent at the same range, the radar displays them as a single target, as shown in figure 5–38. However, as the aircraft approaches the targets, they appear to separate. In the illustration, the airplane is far away from the targets at position **A**. At this distance, the beam width is spreading. As the beam scans across the two targets, there is no point that the beam energy is not reflected, either by one target or the other, because the space between the targets is not wide enough to pass the beam width. In target position **B**, the aircraft is closer to the same two targets; the beam width is narrower, and the targets separate on the display.

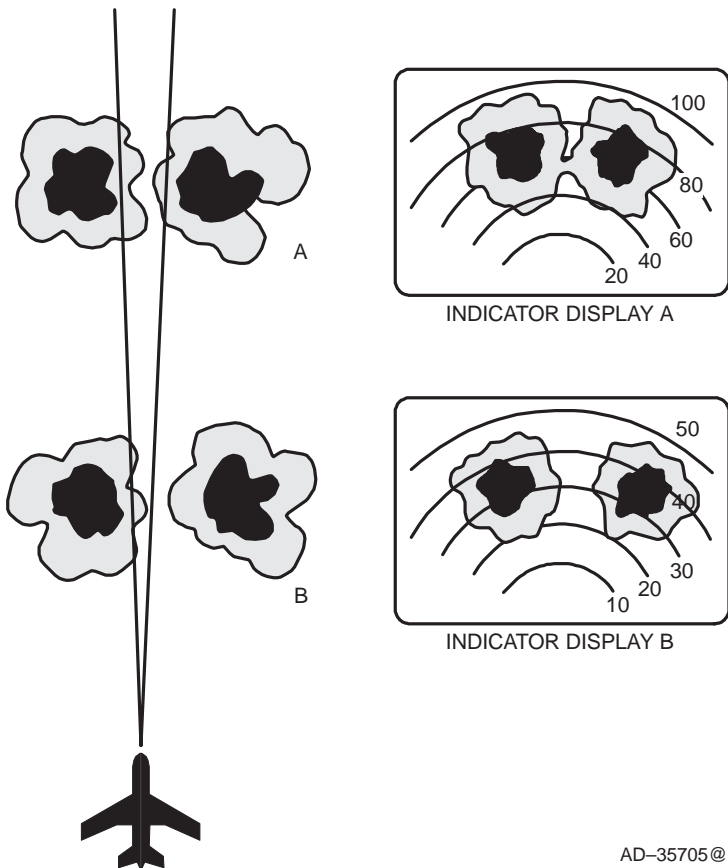

AD-35705@

**Azimuth Resolution in Weather Modes**  
**Figure 5–38**

## **RADOME**

Ice or water on the radome does not generally cause radar failure, but it hampers operation. The radome is constructed of materials that pass the radar energy with little attenuation. Ice or water increases the attenuation making the radar appear to have less sensitivity. Ice can cause refractive distortion, a condition characterized by loss of image definition. If the ice should cause reverberant echoes within the radome, the condition might be indicated by the appearance of nonexistent targets.

The radome can also cause refractive distortion, that would make it appear that the TILT control was out of adjustment, or that bearing indications were somewhat erroneous.

A radome with ice or water trapped within its walls can cause significant attenuation and distortion of the radar signals. This type of attenuation cannot be detected by the radar, even with REACT on, but it can, in extreme cases, cause blind spots. If a target changes significantly in size, shape, or intensity as aircraft heading or attitude change, the radome is probably the cause.



## WEATHER AVOIDANCE

Figure 5–39 illustrates a typical weather display in WX mode. Recommended procedures when using the radar for weather avoidance are given in table 5–9. The procedures are given in bold face, explanations of the procedure follow in normal type face.

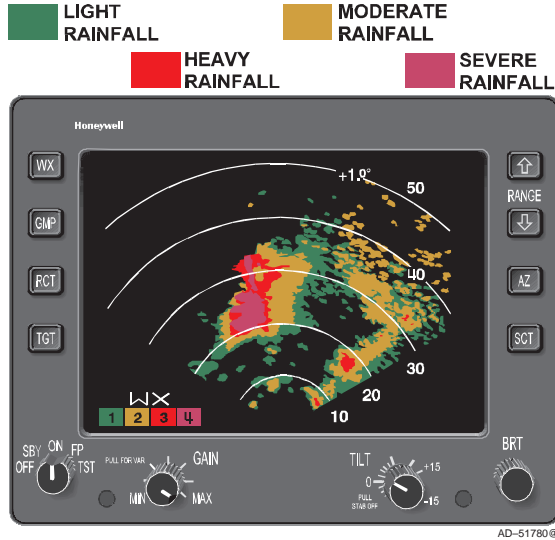

**Weather Display  
Figure 5–39**

Step	Procedure
1	Keep TGT alert enabled when using short ranges to be alerted if a new storm cell develops in the aircraft's flightpath.
2	Keep the gain in preset. The gain control should be in preset except for brief periods when variable gain is used for detailed analysis. Immediately after the analysis, switch back to preset gain.
<p><b>WARNING</b></p> <p><b>DO NOT LEAVE THE RADAR IN VARIABLE GAIN. SIGNIFICANT WEATHER CAN NOT BE DISPLAYED.</b></p>	

**Severe Weather Avoidance Procedures  
Table 5–9 (cont)**

Step	Procedure
3	<p>Any storm with reported tops at or greater than 20,000 feet must be avoided by 20 NM.</p> <p style="text-align: center;"><b>WARNING</b></p> <p><b>DRY HAIL CAN BE PREVALENT AT HIGHER ALTITUDES WITHIN, NEAR, OR ABOVE STORM CELLS, AND SINCE ITS RADAR REFLECTIVITY IS POOR, IT can NOT BE DETECTED.</b></p>
4	<p>For brief periods use increased gain (rotate GAIN control to its maximum cw position) when flying near storm tops. This helps display the normally weaker returns that could be associated with hail.</p>
5	<p><b>When flying at high altitudes, tilt downward frequently to avoid flying above storm tops.</b>            Studies by the National Severe Storms Laboratory (NSSL) of Oklahoma have determined that thunderstorms extending to 60,000 ft show little variation of turbulence intensity with altitude.</p> <p>Ice crystals are poor reflectors. Rain water at the lower altitudes produce a strong echo, however at higher altitudes, the nonreflective ice produces a weak echo as the antenna is tilted up. Therefore, though the intensity of the echo diminishes with altitude, it does not mean the severity of the turbulence has diminished.</p> <p><b>NOTE:</b> If the TILT control is left in a fixed position at the higher flight levels, a storm detected at long range can appear to become weaker and actually disappear as it is approached. This occurs because the storm cell that was fully within the beam at 100 NM gradually passes out of and under the radar beam.</p>
6	<p><b>When flying at low altitudes rotate tilt upward frequently to avoid flying under a thunderstorm.</b>            There is some evidence that maximum turbulence exists at middle heights in storms (20,000 to 30,000 ft); however, turbulence beneath a storm is not to be minimized. However, the lower altitude can be affected by strong outflow winds and severe turbulence where thunderstorms are present. The same turbulence considerations that apply to high altitude flight near storms apply to low altitude flight.</p>

**Severe Weather Avoidance Procedures  
Table 5-9 (cont)**

Step	Procedure
7	<p><b>Avoid all rapidly moving echoes by 20 miles.</b> A single thunderstorm echo, a line of echoes, or a cluster of echoes moving 40 knots or more often contain severe weather. Although nearby, slower moving echoes can contain more intense aviation hazards, all rapidly moving echoes warrant close observation. Fast moving, broken-to solid-line echoes are particularly disruptive to aircraft operations.</p>
8	<p><b>Avoid, the entire cell if any portion of the cell is red or magenta by 20 NM.</b> The stronger the radar return, the greater the frequency and severity of turbulence and hail.</p>
9	<p><b>Avoid all rapidly growing storms by 20 miles.</b> When severe storms and rapid development are evident, the intensity of the radar return can increase by a huge factor in a matter of minutes. Moreover, the summit of the storm cells can grow at 7000 ft/min. The pilot cannot expect a flightpath through such a field of strong storms separated by 20 to 30 NM to be free of severe turbulence.</p>
10	<p><b>Avoid all storms showing erratic motion by 20 miles.</b></p> <p>Thunderstorms tend to move with the average wind that exists between the base and top of the cloud. Any motion differing from this is considered erratic and can indicate the storm is severe. There are several causes of erratic motion. They can act individually or in concert. Three of the most important causes of erratic motion are:</p> <ol style="list-style-type: none"> <li>1. <b>Moisture Source.</b> Thunderstorms tend to grow toward a layer of very moist air (usually south or southeast in the U.S.) in the lowest 1500 to 5000 ft above the earth's surface. Moist air generates most of the energy for the storm's growth and activity. Thus, a thunderstorm can tend to move with the average wind flow around it, but also grow toward moisture. When the growth toward moisture is rapid, the echo motion often appears erratic. On at least one occasion, a thunderstorm echo moved in direct opposition to the average wind!</li> </ol>

**Severe Weather Avoidance Procedures  
Table 5-9 (cont)**

Step	Procedure
10 (cont)	<p>2. <b>Disturbed Wind Flow.</b> Sometimes thunderstorm updrafts block winds near the thunderstorm and act much like a rock in a shallow river bed. This pillar of updraft forces the winds outside the storm to flow around the storm instead of carrying it along. This also happens in wake eddies that often form downstream of the blocking updraft</p> <p>3. <b>Interaction With Other Storms.</b> A thunderstorm that is located between another storm and its moisture source can cause the blocked storm to have erratic motion. Sometimes the blocking of moisture is effective enough to cause the thunderstorm to dissipate.</p> <p>Three of the most common erratic motions are:</p> <p>1. <b>Right Turning Echo.</b> This is the most frequently observed erratic motion. Sometimes a thunderstorm echo traveling the same direction and speed as nearby thunderstorm echoes, slows, and turns to the right of its previous motion. The erratic motion can last an hour or more before it resumes its previous motion. The storm should be considered severe while this erratic motion is in progress.</p> <p>2. <b>Splitting Echoes.</b> Sometimes a large (20-mile or larger diameter) echo splits into two echoes. The southernmost echo often slows, turns to the right of its previous motion, and becomes severe with large hail and extreme turbulence.</p> <p>If a tornado develops, it is usually at the right rear portion of the southern echo. When the storm weakens, it usually resumes its original direction of movement. The northern echo moves left of the mean wind, increases speed and often produces large hail and extreme turbulence.</p> <p>3. <b>Merging Echoes.</b> Merging echoes sometimes become severe, but often the circulation of the merging cells interfere with each other preventing intensification. The greatest likelihood of aviation hazards is at the right rear section of the echo.</p>

**Severe Weather Avoidance Procedures**  
**Table 5-9 (cont)**

Step	Procedure
11	<p><b>Never continue flight towards or into a radar shadow or the blue REACT field.</b></p> <p style="text-align: center;"><b>WARNING</b></p> <p><b>STORMS SITUATED BEHIND INTERVENING RAINFALL CAN BE MORE SEVERE THAN DEPICTED ON THE DISPLAY.</b></p> <p>If the radar signal can penetrate a storm, the target displayed seems to cast a shadow with no visible returns. This indicates that the storm contains a great amount of rain, that attenuates the signal and prevents the radar from seeing beyond the cell under observation. The REACT blue field shows areas where attenuation could be hiding severe weather. Both the shadow and the blue field are to be avoided by 20 miles. Keep the REACT blue field turned on. The blue field forms fingers that point toward the stronger cells.</p>

**Severe Weather Avoidance Procedures  
Table 5-9**

## **Configurations of Individual Echoes (Northern Hemisphere)**

Sometimes a large echo develops configurations that are associated with particularly severe aviation hazards. Several of these are discussed below.

### **AVOID HOOK ECHOES BY 20 MILES**

The hook is probably the best known echo associated with severe weather. It is an appendage of a thunderstorm echo and usually only appears on weather radars. Figure 5-40 shows a hook echo.

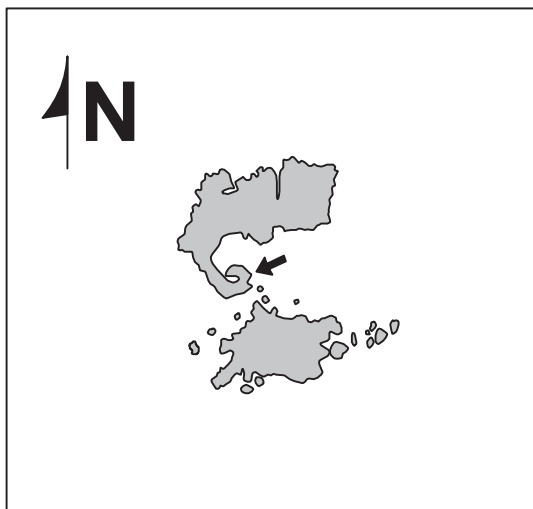

AD-15560-R1@

### Typical Hook Pattern Figure 5-40

The hooks are located at the right rear side of the thunderstorm echo's direction of movement (usually the southwest quadrant).

The hook is not the tornado echo! A small scale low pressure area is centered at the right rear side of the thunderstorm echo near its edge. The low usually ranges from about 3 to 10 miles in diameter. Precipitation is drawn around the low's cyclonic circulation to form the characteristic hook shape. Tornadoes form within the low near hook. According to statistics from the NSSL, almost 60 percent of all observed hook echoes have tornadoes associated with them. A tornado is always suspected when a hook echo is seen.

A hook can form with no tornadoes and vice versa. However, when a bona fide hook is observed on a weather radar, moderate or greater turbulence, strong shifting surface winds, and hail are often nearby and aircraft should avoid them.

There are many patterns on radar that resemble hook echoes but are not associated with severe weather. Severe weather hook echoes last at least 5 minutes and are less than 25 miles in diameter. The favored location for hook echoes is to the right rear of a large and strong cell, however, in rare cases tornadoes occur with hooks in other parts of the cell.

**AVOID V-NOTCH BY 20 MILES**

A large isolated echo sometimes has the configuration that is shown in figure 5-41. This echo is called V-notch or flying eagle although some imagination may be needed by the reader to see the eagle. V-notch echoes are formed by the wind pattern at the leading edge (left front) of the echo. Thunderstorm echoes with V-notches are often severe, containing strong gusty winds, hail, or funnel clouds, but not all V-notches indicate severe weather. Again, severe weather is most likely at **S** in figure 5-41.

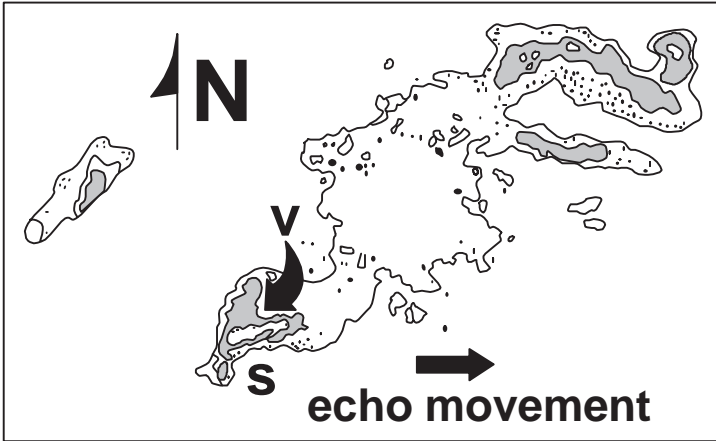

AD-15561-R1@

**V-Notch Echo, Pendant Shape**  
**Figure 5-41**

## AVOID PENDANT BY 20 MILES

The pendant shape shown in figure 5–42, represents one of the most severe storms – the supercell. One study concluded that, in supercells:

- The average maximum size of hail is over 2 inches (5.3 cm)
- The average width of the hail swath is over 12.5 miles (20.2 km)
- Sixty percent produce funnel clouds or tornadoes.

The classic pendant shape echo is shown in figure 5–42. Note the general pendant shape, the hook, and the steep rain gradient. This storm is extremely dangerous and must be avoided.

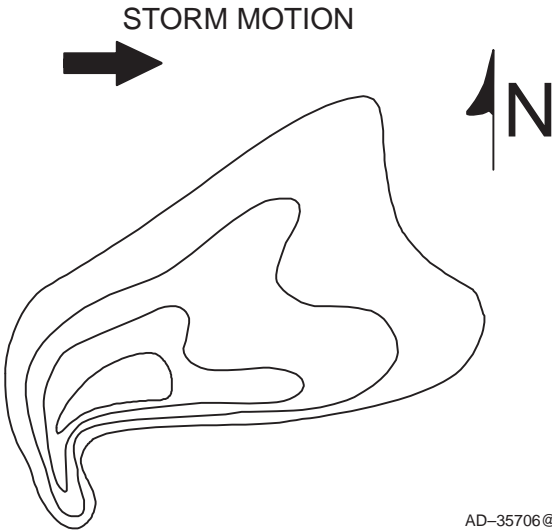

**The Classic Pendant Shape  
Figure 5–42**



## AVOID STEEP RAIN GRADIENTS BY 20 MILES

Figure 5–43 shows steep rain gradients. Refer to the paragraph, Interpreting Weather Radar Images, in this section, for a detailed explanation of weather images.

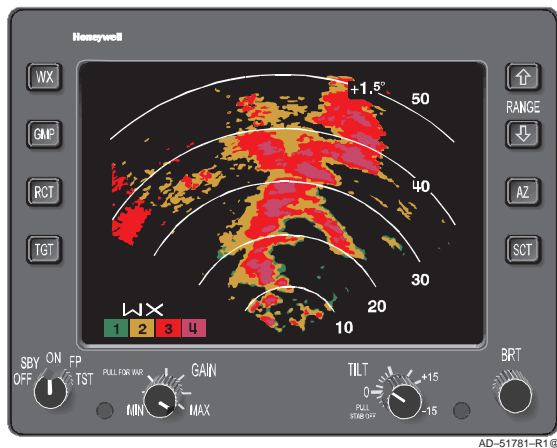

**Rain Gradients**  
Figure 5–43

## AVOID ALL CRESCENT SHAPED ECHOES BY 20 MILES

A crescent shaped echo, shown in figure 5–44, with its tips pointing away from the aircraft indicates a storm cell that has attenuated the radar energy to the point where the entire storm cell is not displayed. This is especially true if the trailing edge is very crisp and well defined with what appears to be a steep rain gradient.

When REACT is selected, the area behind the steep rain gradient fills in with cyan.

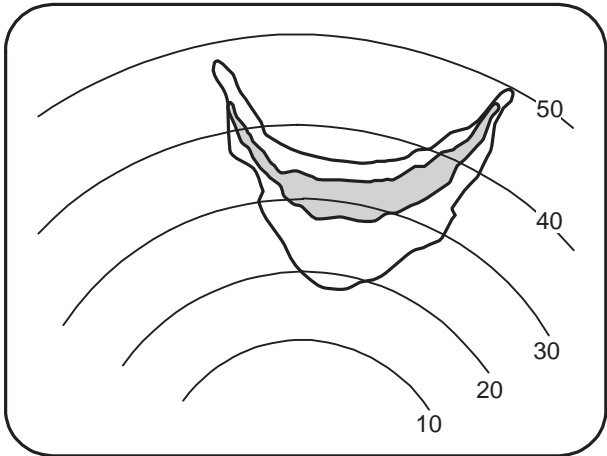

AD-22161-R1@

**Crescent Shape  
Figure 5-44**

### **Line Configurations**

#### **AVOID THUNDERSTORM ECHOES AT THE SOUTH END OF A LINE OR AT A BREAK IN A LINE BY 20 MILES**

The echo at the south end of a line of echoes is often severe and so too is the storm on the north side of a break in line. Breaks frequently fill in and are particularly hazardous for this reason. Breaks should be avoided unless they are 40 miles wide. This is usually enough room to avoid thunderstorm hazards.

The above two locations favor severe thunderstorm formation since these storms have less competition for low level moisture than others nearby.

**AVOID LINE ECHO WAVE PATTERNS (LEWP) BY 20 MILES**

One portion of a line can accelerate and cause the line to assume a wave-like configuration. Figure 5-45 is an example of an LEWP. The most severe weather is likely at **S**. LEWPs form solid or nearly solid lines that are dangerous to aircraft operations and disruptive to normal air traffic flow.

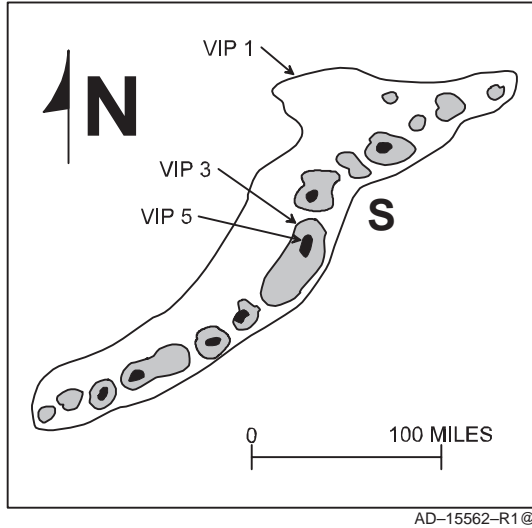

**Line Echo Wave Pattern (LEWP)**  
**Figure 5-45**

The **S** indicates the location of the greatest hazards to aviation. The next greatest probability is anywhere along the advancing (usually east or southeast) edge of the line.

### AVOID BOW-SHAPED LINE OF ECHOES BY 20 MILES

Sometimes a fast moving, broken to solid thunderstorm line becomes bow-shaped, as shown in figure 5-46. Severe weather is most likely along the bulge and at the north end, but severe weather can occur at any point along the line. Bow-shaped lines are particularly disruptive to aircraft operations because they are broken to solid and can accelerate to speeds in excess of 70 knots within an hour.

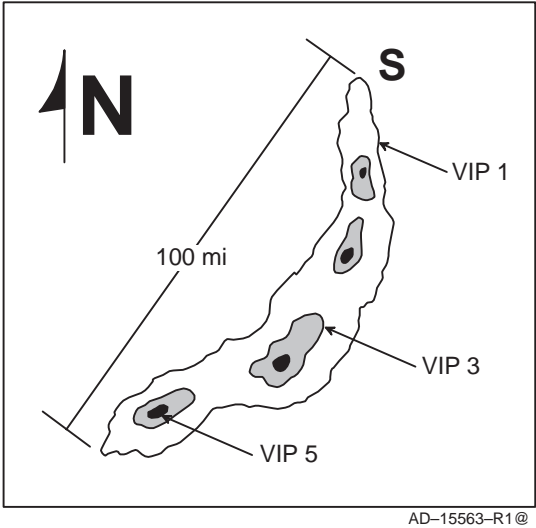

**Bow-Shaped Line of Thunderstorms**  
**Figure 5-46**

## **Additional Hazards**

### **TURBULENCE VERSUS DISTANCE FROM STORM CORE**

The stronger the return, the further the turbulence is encountered from the storm core at any altitude. Severe turbulence is often found in the tenuous anvil cloud 15 to 20 miles downwind from a severe storm core. Moreover, the storm cloud is only the visible portion of a turbulent system whose up and down drafts often extend outside of the storm proper.

### **TURBULENCE VERSUS DISTANCE FROM STORM EDGE**

Severe clear-air turbulence can occur near a storm, most often on the downwind side. Tornadoes are located in a variety of positions with respect to associated echoes, but many of the most intense and enduring occur on the up-relative-wind side. The air rising in a tornado can contribute to a downwind area of strong echoes, while the tornado itself can or can not return an echo. Echo hooks and appendages, though useful indexes of tornadoes, are not infallible guides.

The appearance of a hook warns the pilot to stay away, but just because the tornado cannot be seen is no assurance that there is no tornado present.

Expect severe turbulence up to 20 NM away from severe storms; this turbulence often has a well-defined radar echo boundary. This distance decreases somewhat with weaker storms that display less well-defined echo boundaries.

Appendix A, Federal Aviation Administration (FAA) Advisory Circulars, of this manual contains several advisory circulars. It is recommended that you become familiar with them.

## GROUND MAPPING

Ground mapping operation is selected with the GMAP button. An example of ground map display is shown in figure 5–47. Turn the TILT control down until the desired amount of terrain is displayed. The degree of down-tilt depends upon the type of terrain, aircraft altitude, and selected range. Tables 5–10 and 5–11 show tilt settings for maximal ground target display at selected ranges.

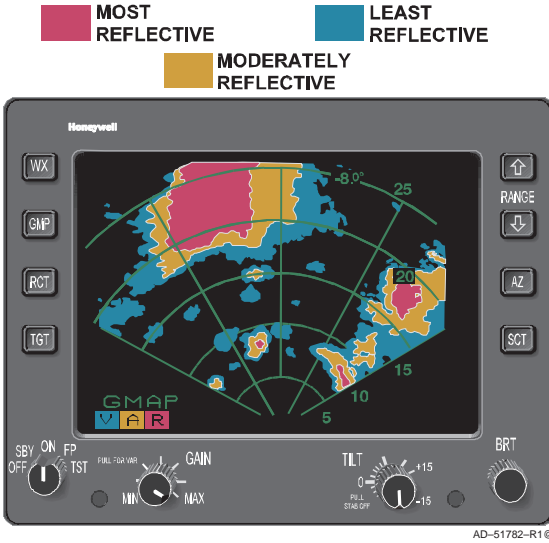

**Ground Mapping Display**  
**Figure 5–47**

For the low ranges (5, 10, 25, and 50 NM), the transmitter pulsewidth is narrowed and the receiver bandwidth is widened to enhance the identification of small targets. In addition, the receiver STC characteristics are altered to better equalize ground target reflections versus range. As a result, the preset gain position is generally used to display the desired map. The pilot can manually decrease the gain to eliminate unwanted clutter.

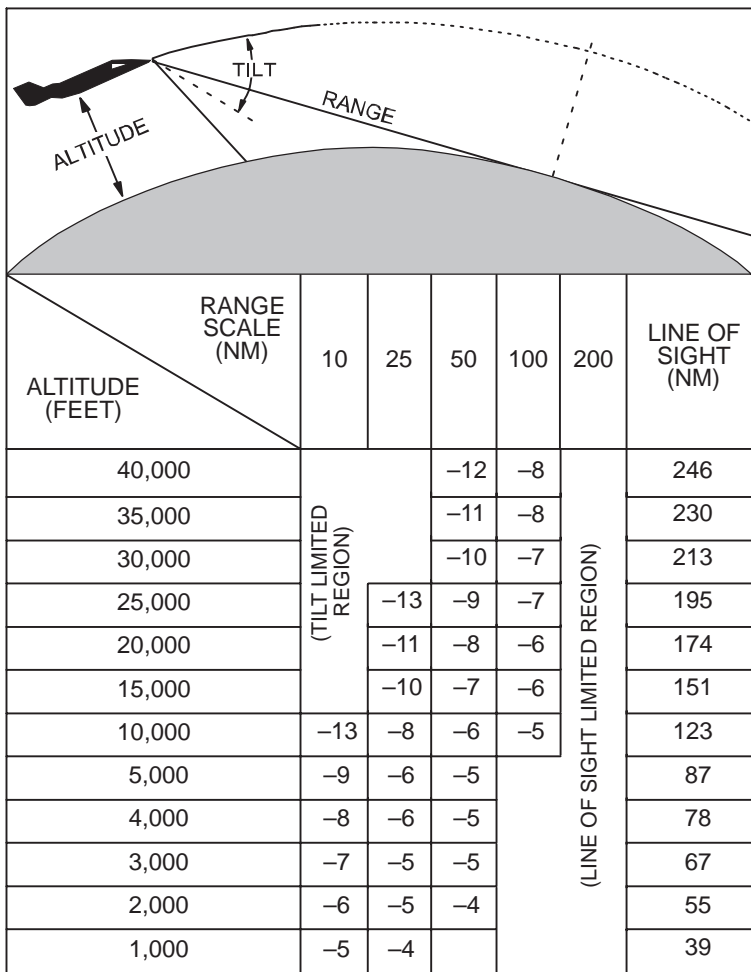

AD-35710@

**TILT Setting for Maximal Ground Target Display  
12-Inch Radiator  
Table 5-10**

**NOTE:** The line of sight distance is nominal. Atmospheric conditions and terrains offset this value.

ALTITUDE (FEET)	RANGE SCALE (MILES)							LINE OF SIGHT (MILES)	
	5	10	25	50	100	200			
40,000	(TILT LIMITED REGION)			-11	-7	-6	(LINE OF SIGHT LIMITED REGION)	246	
35,000				-10	-7	-5		230	
30,000				-9	-6	-5		213	
25,000				-8	-6			195	
20,000				-7	-5			174	
15,000					-8	-6		-5	151
10,000					-12	-7		-5	-4
5,000	-12	-8	-7	-4		87			
4,000	-11	-7	-5	-4		78			
3,000	-8	-6	-4	-3		67			
2,000	-6	-5	-4	-3		55			
1,000	-5	-4	-3			39			

AD-12041@

**TILT Setting for Maximal Ground Target Display  
18-Inch Radiator  
Table 5-11**

**NOTE:** The line of sight distance is nominal. Atmospheric conditions and terrains offset this value.



## 6. Maximum Permissible Exposure Level (MPEL)

Heating and radiation effects of weather radar can be hazardous to life. Personnel should remain at a distance greater than **R** from the radiating antenna in order to be outside of the envelope in which radiation exposure levels equal or exceed  $10 \text{ mW/cm}^2$ , the limit recommended in FAA Advisory Circular AC No. 20-68B, August 8, 1980, Subject: Recommended Radiation Safety Precautions for Ground Operation of Airborne Weather Radar. The radius, **R**, to the maximum permissible exposure level boundary is calculated for the radar system on the basis of radiator diameter, rated peak-power output, and duty cycle. The greater of the distances calculated for either the far-field or near-field is based on the recommendations outlined in AC No. 20-68B. The advisory circular is reproduced without Appendix 1 in Appendix A of this manual.

The IEEE Standard for Safety Level with Respect to Human Exposure to Radio Frequency Electronic Fields 3kHz to 300 GHz (IEEE C95.1-1991), recommends an exposure level of no more than  $6 \text{ mW/cm}^2$ .

Honeywell recommends that operators follow the  $6 \text{ mW/cm}^2$  standard. Figure 6-1 shows MPEL for both exposure levels.

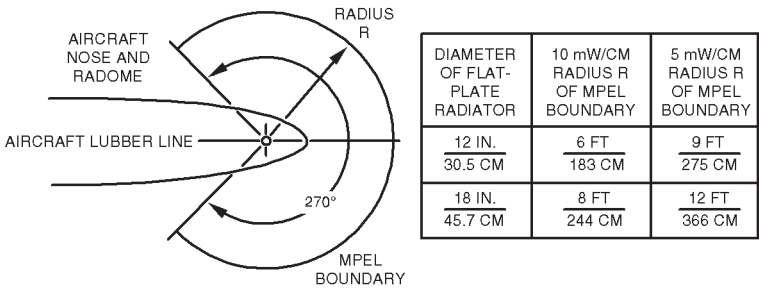

ID-131613

**MPEL Boundary**  
**Figure 6-1**

## 7. In-Flight Adjustments

### PITCH AND ROLL TRIM ADJUSTMENTS

The PRIMUS® 660 is delivered from the Honeywell factory or repair facility adjusted for correct pitch and roll stabilization and should be ready for use. However, due to the tolerances of some vertical reference sources, make a final adjustment whenever the radar or vertical reference is replaced on the aircraft, or if stabilization problems are observed in flight.

The four trim adjustments and their effects are summarized in table 7-1.

<b>Trim Adjustment</b>	<b>Flight Condition</b>	<b>Effect On Ground Return Display (Over Level Terrain)</b>
Roll offset	Straight and level	Nonsymmetrical display
Pitch offset	Straight and level	Ground displays do not follow contour of range arcs.
Roll gain	Constant roll angle >20°	Nonsymmetrical display
Pitch gain	Constant pitch angle >5°	Ground displays do not follow contour of range arcs.
<b>NOTE:</b> Generally, it is recommended to perform trim adjustments only if noticeable effects are being observed.		

**Pitch and Roll Trim Adjustments Criteria**  
**Table 7-1**

- NOTES:**
1. Depending on the installation, not all of the adjustments shown in table 7-1 are available. If STAB TRIM ENABLE programming pin is open, only the roll offset adjustment is available. If STAB TRIM ENABLE programming pin is grounded, all four adjustments are available. Consult the installation configuration information for details.
  2. After any adjustment procedure is completed, monitor the ground returns displayed by the radar during several pitch and roll maneuvers. Verify that the ground returns stay somewhat constant during changes in aircraft orientations. If not, repeat the adjustment procedure.
  3. After the trim adjustment feature is selected, more than one adjustment can be made. They are available in the sequence shown in table 7-2, and can be done in the sequence of first finishing one adjustment, then proceeding to do the next by pushing the STAB button.
  4. The in-flight stabilization adjustment range is limited. If you cannot achieve a satisfactory adjustment in-flight, a ground adjustment is required.
  5. Proper radar stabilization depends on the accuracy and stability of the installed attitude source.
  6. The procedures in tables 7-3, 7-4, 7-6, and 7-8 that instruct you to “push the STAB button” assume that you are using a controller rather than an indicator. If you are using an indicator, pulling the TILT knob out or pushing it in is equal to pushing the STAB button on a controller.
  7. When you finish the in-flight stabilization procedures, the STAB can be OFF (stab light on), an additional push of the button is required to turn stab back on.

## Level Flight Stabilization Check

Follow the procedure in table 7–2 to determine if you need to perform the roll offset adjustment.

Step	Procedure
1	Trim the aircraft for straight and level flight in smooth, clear air over level terrain at an altitude of at least 10,000 feet AGL.
2	Select the 50–mile range and GMAP mode.
3	Adjust the tilt control until your radar display shows a solid band of ground returns starting at the 40–mile range arc.
4	After several antenna sweeps, verify that ground returns follow the range arc closely and are equally displayed on both sides as shown in figure 7–1. If the ground returns are not equally displayed on both sides (see examples in figures 7–2 and 7–3), perform the roll offset adjustment shown in table 7–3.

**Stabilization in Straight and Level Flight Check Procedure**  
**Table 7–2**

**NOTE:** A condition where the strongest ground targets move from side to side over a period of several minutes, can be caused by the gyro erection circuits chasing a slow wingwalk in the flightpath. Roll offset adjustment cannot compensate for this condition.

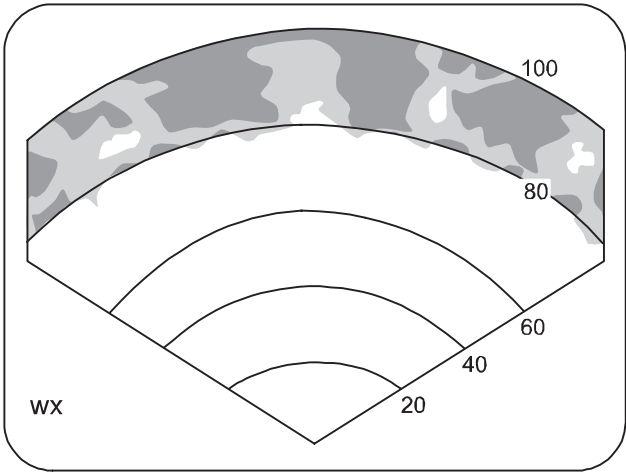

AD-17720-R3@

**Symmetrical Ground Returns  
Figure 7-1**

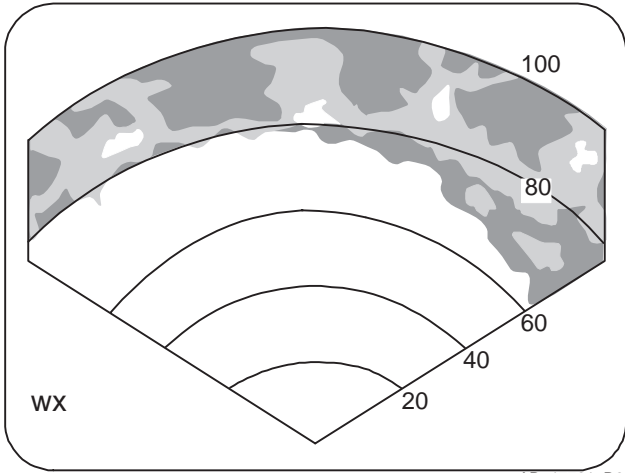

AD-17721-R2@

**Ground Return Indicating Misalignment (Right)  
Figure 7-2**

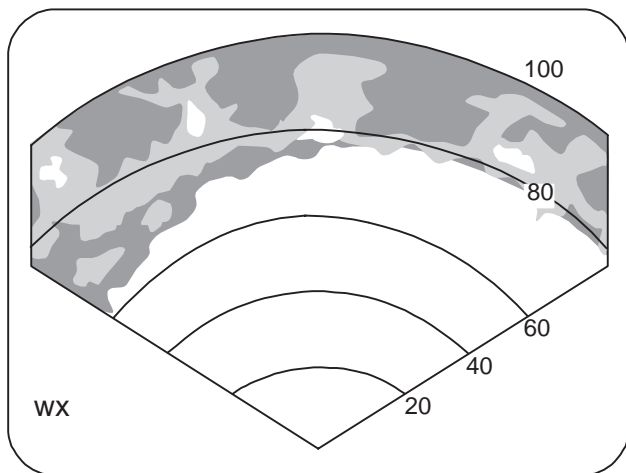

AD-17722-R2@

**Ground Return Indicating Misalignment (Left)**  
**Figure 7-3**

## ROLL OFFSET ADJUSTMENT

You can make an in-flight adjustment when level flight stabilization errors are detected. This procedure is done by either the WC-660 Weather Radar Controller or the WI-650/660 Weather Radar Indicator. During this procedure, described in table 7-3, the GAIN control acts as roll offset control. After the procedure the GAIN control reverts to acting as a gain control.

Step	Procedure
1	If two controllers are installed, one <u>must</u> be turned off. If an indicator is used as the controller, the procedure is the same as given below.
2	Fly to an altitude of 10,000 feet above ground level (AGL), or greater.
3	Set range to 50 NM.

**In-Flight Roll Offset Adjustment Procedure**  
**Table 7-3 (cont)**

Step	Procedure
4	Adjust the tilt down until a solid band of ground returns are shown on the screen. Then adjust the tilt until the green region of the ground returns start at about 40 NM.
5	Select STAB (STB) 4 times within 3 seconds. A display with text instructions is displayed. See figure 7-4. The radar unit is in the roll offset adjustment mode.
6	Pull out the GAIN knob to make a roll offset adjustment. See figure 7-5 for a typical display. The offset range is from $-2.0^{\circ}$ to $+2.0^{\circ}$ and is adjustable by the GAIN knob. The polarity of the GAIN knob is such that clockwise rotation of the knob causes the antenna to move down when scanning on the right side.
7	While flying straight and level, adjust the GAIN knob until ground clutter display is symmetrical.
8	Push in the GAIN knob. When the GAIN knob is pushed in, the display returns to the previous message.
9	Push the STAB (STB) button to exit, or to go to the next menu (pitch offset), if the full stab trim mode is enabled in your installation.
<p><b>NOTE:</b> Once set, the roll compensation is stored in nonvolatile memory in the RTA. It is remembered when the system is powered down.</p>	

**In-Flight Roll Offset Adjustment Procedure  
Table 7-3**



**Roll Offset Adjustment Display – Initial  
Figure 7-4**

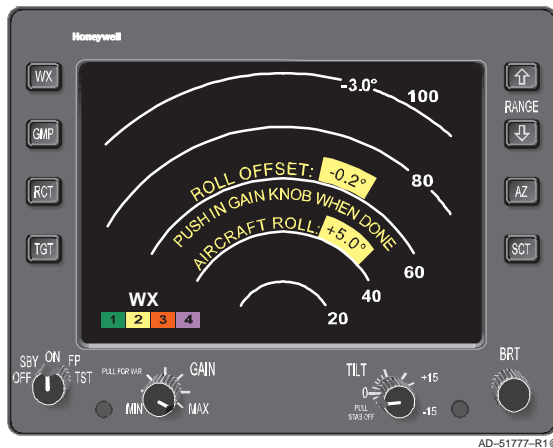

**Roll Offset Adjustment Display – Final  
Figure 7-5**



## PITCH OFFSET ADJUSTMENT

This in-flight adjustment is made in straight and level flight when the ground returns do not follow the contours of the radar display range arcs. The procedure is listed in table 7-4.

Step	Procedure
1	If two controllers are installed, one <u>must</u> be turned off. If an indicator is used, the procedure is the same as given below.
2	Fly to an altitude of 10,000 feet AGL or greater.
3	Set range to 50 NM.
4	Adjust the tilt down until a solid band of ground returns are shown on the screen. Then adjust the tilt until the green region of the ground returns start at about 40 NM.
5	Select STAB (STB) 4 times within 3 seconds. The roll offset display is shown.
6	From the roll offset entry menu, push the STAB (STB) button once more to bring up the pitch offset entry menu.
7	To change the pitch offset value, pull out the GAIN knob and rotate it. The offset range is from $-2.0^{\circ}$ to $+2.0^{\circ}$ .
8	When flying straight and level, adjust so the contour of the ground returns follow the contour of the range arcs as closely as possible.
9	When change is completed, push in the GAIN knob. The display returns to the previous message.
10	Push the STAB (STB) button to go to the next menu (roll gain).

### Pitch Offset Adjustment Procedure

Table 7-4

## ROLL STABILIZATION CHECK

Once proper operation in level flight has been established, you can verify correct roll stabilization using the procedures in table 7–5.

Step	Procedure
1	Trim the aircraft for straight and level flight in smooth, clear air over level terrain at an altitude of at least 10,000 feet AGL.
2	Select the 50-mile range and GMAP mode.
3	Adjust the TILT control until your radar display shows a solid band of ground returns starting at the 40-mile range arc. See figure 7–6.
4	Place the aircraft in a 20-degree (or greater) roll to the right. If there is little change to the arc of ground returns, the roll stabilization is good.
5	If ground returns come in closer on the right side and go out on the left side, the roll is understabilized. See figure 7–7.
6	If the ground returns go out on the right side and come in closer on the left side, the roll is overstabilized. See figure 7–8.
7	If the roll is understabilized or overstabilized, you can perform an in-flight roll gain adjustment as shown in table 7–6.

**Roll Stabilization (While Turning) Check Procedure**  
Table 7–5

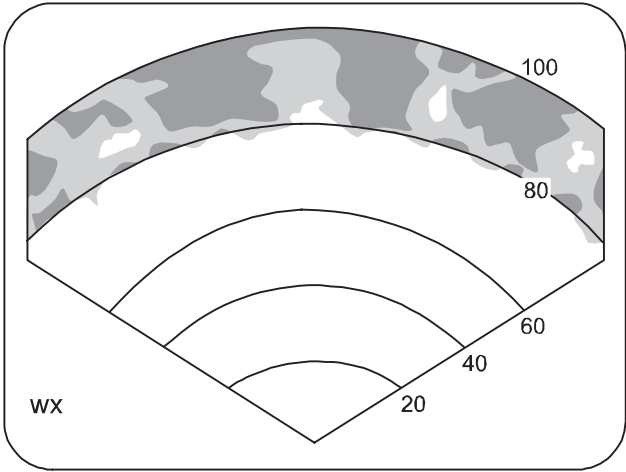

AD-17720-R3@

**Symmetrical Ground Returns, Level Flight  
and Good Roll Stabilization  
Figure 7-6**

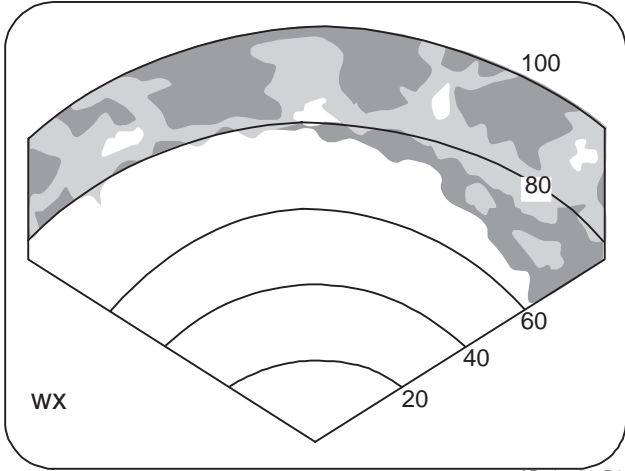

AD-17721-R2@

**Understabilization in a Right Roll  
Figure 7-7**

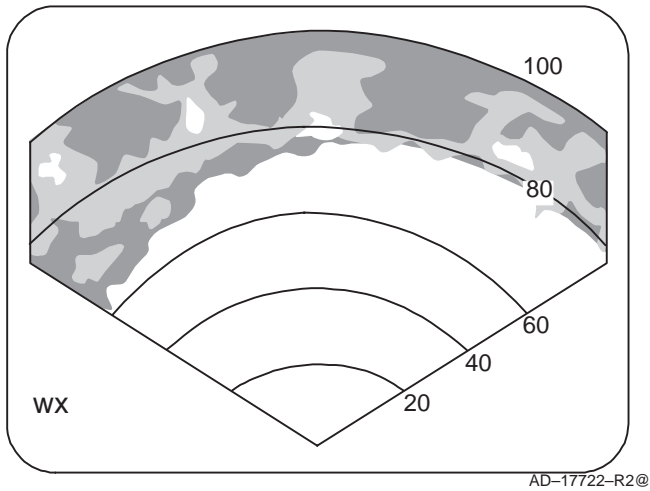

**Overstabilization in a Right Roll  
Figure 7-8**

## ROLL GAIN ADJUSTMENT

This in-flight adjustment is made in a bank when the ground returns do not remain symmetrical during turns. The procedure is listed in table 7-6.

Step	Procedure
1	If two controllers are installed, one <u>must</u> be turned off. If an indicator is used as the controller, the procedure is the same as given below.
2	Fly to an altitude of 10,000 feet AGL or greater.
3	Set range to 50 NM.
4	Adjust the tilt down until a solid band of ground returns are shown on the screen. Then adjust the tilt until the green region of the ground returns start at about 40 NM.
5	Select STAB (STB) 4 times within 3 seconds. A display with text instructions for roll offset is shown.

**Roll Gain Adjustment Procedure  
Table 7-6 (cont)**

Step	Procedure
6	From the roll offset entry menu, push the STAB (STB) button twice more to bring up the roll gain entry menu.
7	To change the roll gain value, pull out the GAIN knob and rotate it. The roll gain adjustment range is from 90 to 110%.
8	While flying with a steady roll angle of at least 20°, adjust for symmetrical display of ground returns at the 40–NM range arc..
9	When change is completed, push in the GAIN knob. The display returns to the previous message.
10	Push the STAB (STB) button to go to the next menu (pitch gain).

### Roll Gain Adjustment Procedure

Table 7–6

## PITCH STABILIZATION CHECK

This in–flight adjustment is made in a bank when the ground returns do not remain symmetrical during turns. The procedure is listed in table 7–7.

Step	Procedure
1	Trim the aircraft for straight and level flight in smooth, clear air over level terrain at an altitude of at least 10,000 feet AGL.
2	Select the 50–mile range and GMAP mode.
3	Adjust the TILT control until your radar display shows a solid band of ground returns starting at the 40–mile range arc. See figure 7–9.
4	Place the aircraft between 5 and 10° pitch up. If there is little change to the arc of ground returns, the pitch stabilization is good.

### Pitch Stabilization Check Procedure

Table 7–7 (cont)

Step	Procedure
5	If the display of ground returns goes out in range, the pitch is understabilized. See figure 7-10.
6	If the display of ground returns comes in closer in range, the pitch is overstabilized. See figure 7-11.
7	If the pitch is understabilized or overstabilized, you can wish to perform an in-flight pitch gain adjustment as shown in table 7-8.

**Pitch Stabilization Check Procedure**  
**Table 7-7**

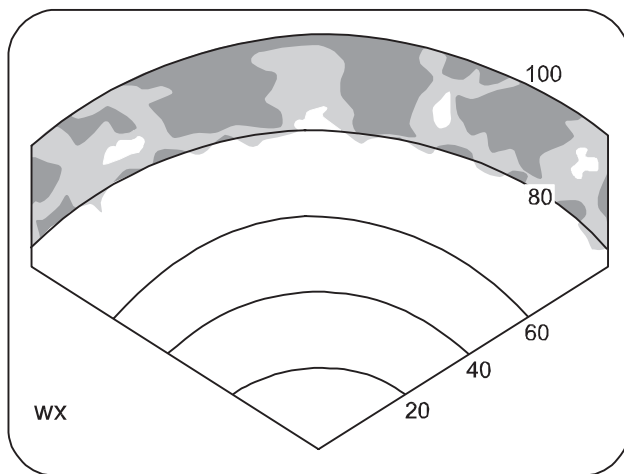

AD-17720-R3@

**Level Flight and Good Pitch Stabilization**  
**Figure 7-9**

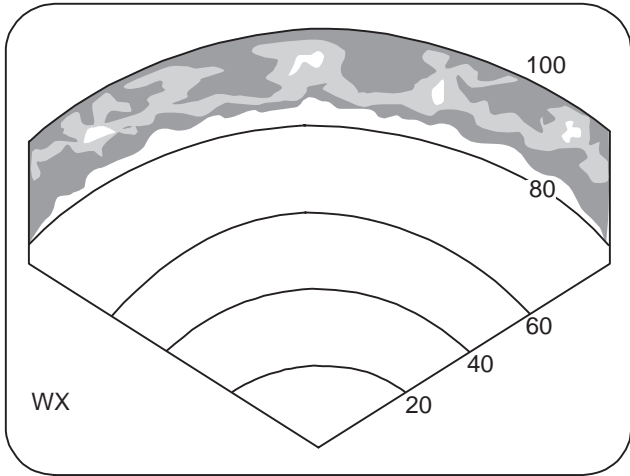

**Understabilized in Pitch Up  
Figure 7-10**

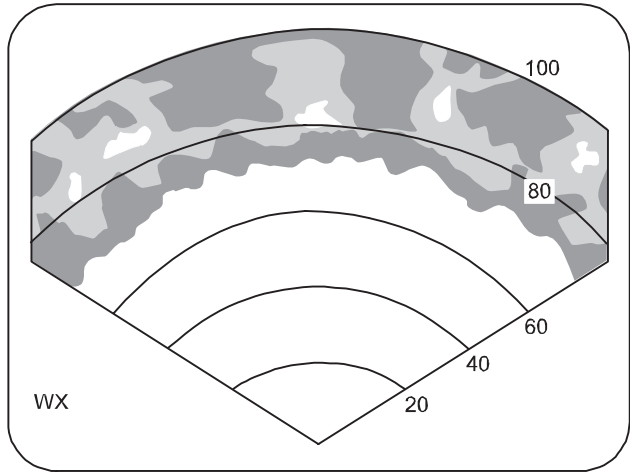

**Overstabilized in Pitch Up  
Figure 7-11**

## PITCH GAIN ADJUSTMENT

This in-flight adjustment is made in a bank when the ground returns do not follow the contours of the range arcs during turns. The procedure is listed in table 7–8.

Step	Procedure
1	If two controllers are installed, one <u>must</u> be turned off. If an indicator is used as the controller, the procedure is the same as given below.
2	Fly to an altitude of 10,000 feet AGL or greater.
3	Set range to 50 NM.
4	Adjust the tilt down until a solid band of ground returns are shown on the screen. Then adjust the tilt until the green region of the ground returns start at about 40 NM.
5	Push STAB (STB) 4 times within 3 seconds. A display with text instruction is shown.
6	From the roll offset entry menu, push the STAB (STB) button 3 more times to bring up the pitch gain entry menu.
7	To change the pitch gain value, pull out the GAIN knob and rotate it. The pitch gain adjustment range is from 90 to 110%.
8	While flying with a steady pitch angle of $>5^\circ$ , adjust so the contour of the ground returns follow the contour of the range arcs as closely as possible.
9	When change is completed, push in the GAIN knob. The display returns to the previous message.
10	Push the STAB button to exit the mode and save the value in nonvolatile memory.

**Pitch Gain Adjustment Procedure**  
**Table 7–8**



## 8. In-Flight Troubleshooting

The PRIMUS® 660 Digital Weather Radar System can provide troubleshooting information on one of two formats:

- Fault codes
- Text faults.

The selection is made at the time of installation. This section describes access and use of this information.

If the fault codes option is selected, they are shown in place of the tilt angle. The text fault option provides English text as well as fault codes in the radar test pattern areas.

Critical functions in the receiver transmitter antenna (RTA) are continuously monitored. Each fault condition has a corresponding 2-digit fault code (FC). Additionally, a fault name, a pilot message, and a line maintenance message are associated with each fault condition.

Faults can be accessed on the ground, or while airborne.

- Display, indicator, or RTA malfunction
- FAIL annunciation on weather indicator or EFIS display.

If the feature TEXT FAULTS is enabled, the radar test pattern area displays plain English text fault information. If it is not enabled, only the fault code is shown (one at a time) on the indicator or EFIS display.

The PRIMUS® 660 also contains a feature called “Pilot Event Marker” that enables the pilot to record a full set of BITE parameters at any time, typically if the radar seems to be malfunctioning.

- NOTES:**
1. In some EFIS installations, radar failures are only annunciated with an amber WX if faults are not enabled..
  2. In EFIS installations, with TEXT FAULTS enabled, the fault codes are also presented as part of the FAIL annunciation (e.g., FAIL 13).

## TEST MODE WITH TEXT FAULTS ENABLED

When airborne, if the radar is switched to TEST mode, any current faults are displayed.

When on the ground (weight on wheels active) and the radar is switched to TEST mode, any current faults are displayed, followed by up to 32 faults from the last 10 power on cycles. The historic faults are displayed going from the most recent to the oldest and are cycled every two antenna sweeps (approximately 8 seconds). The POC number indicates how many power on counts back into the history the fault occurred. After the last fault, an END OF LIST message is displayed. To recycle through the list again, exit and re-enter the TEST mode.

Table 8–1 describes the six fault data fields that are displayed in figure 8–1.

Field No.	Description
1	Pilot message
2	Line maintenance message
3	Fault code/power-on count
4	Fault name
5	Transmit ON/OFF
6	Strap code
<p><b>NOTES:</b></p> <ol style="list-style-type: none"> <li>1. If airborne, only fault fields 1, 2, and 3 are displayed.</li> <li>2. Airborne, only the current faults are displayed.</li> <li>3. Strap codes indicate the configuration that was done at the time of installation. Refer to the System Description and Installation manual for further explanation.</li> </ol>	

**Fault Data Fields**  
**Table 8–1**

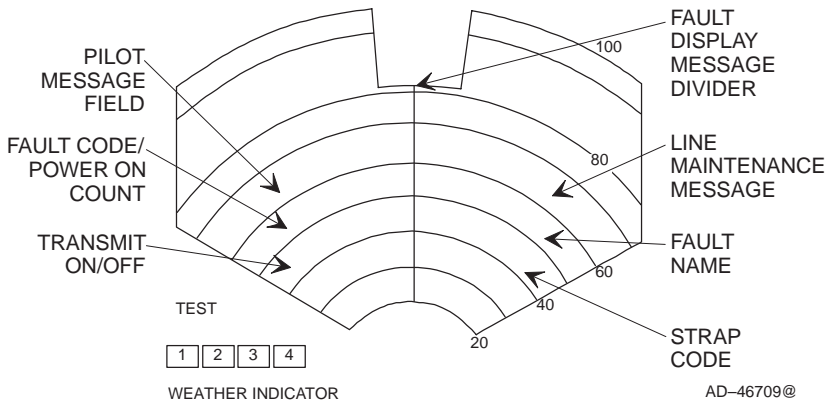

**Fault Annunciation on Weather Indicator  
With TEXT FAULT Fields  
Figure 8-1**

Figure 8-2 shows the fault codes displayed on EFIS with text faults disabled.

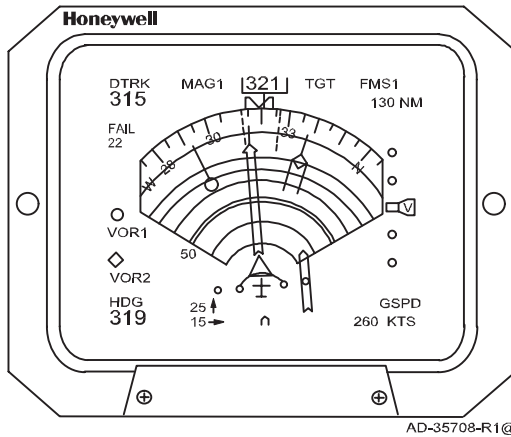

**Fault Code on EFIS Weather Display  
With TEXT FAULTS Disabled  
Figure 8-2**

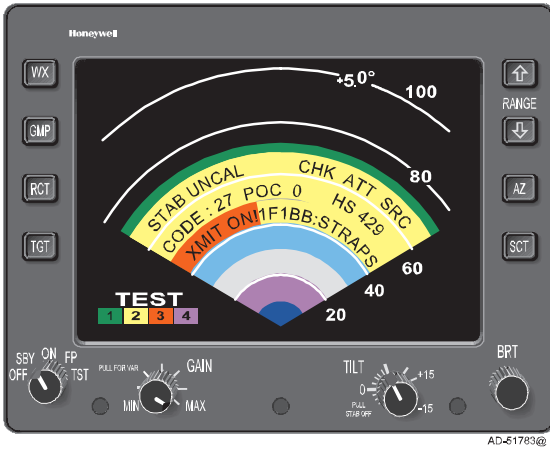

**Radar Indication With Text Fault Enabled (On Ground)**  
**Figure 8-3**

## PILOT EVENT MARKER

At any time a full set of BITE parameters can be recorded by going in and out of variable gain four times (pull GAIN knob for VAR, push for preset, pull for VAR, and push for preset) within three seconds. There is no annunciation on the display after this operation.

This feature can be useful if the radar appears to be malfunctioning and a fail annunciation is not shown on the display. If the pilot event marker is used, it is best to record several sets of data during the period of misoperation. Refer to the PRIMUS® 660 System Description and Installation Manual for information on constructing an interconnect cable for accessing this information.

## FAULT CODE AND TEXT FAULT RELATIONSHIPS

Table 8–2 lists the relationship between:

- Fault codes (FC)
- Pilot/Maintenance (MAINT) Messages
- Fault Name/type/description/cross reference (XREF).

FC	XREF	FAULT DESCRIPTION	FAULT NAME	PILOT MSG	LINE MAINT	FAULT TYPE
01	4808	Startup Code CRC	FLASH CRC	RADAR FAIL	PULL RTA	POWER ON
	4809	IOP Code CRC				
	4810	DSP Code CRC				
	4904	CONFIG Table CRC				
	4905	FPGA Firmware CRC				
02	4846	2V ADC Reference	IOP	RADAR FAIL	PULL RTA	CONTINUOUS
	4903	IOP Ready				POWER ON
	4908	INT ARINC 429 Loopback				POWER ON
	4910	Spurious ARINC Interrupt	IOP	RADAR FAIL	PULL RTA	CONTINUOUS
	4913	ARINC 429 INT Coupling	IOP			POWER ON
03	4806	EEPROM Timer CRC	FLASH CRC	RADAR FAIL	PULL RTA	POWER ON
	4811	EEPROM POC	EEPROM			POWER ON
	4842	STAB Trim CRC		EEPROM	REDO STAB TRIM	REDO STAB TRIM
	4912	Calibration CRC	IOP	RADAR FAIL	PULL RTA	
04	4812	IOP Mailbox	MAILBOX RAM	RADAR FAIL	PULL RTA	POWER ON
	4818	DSP Mailbox				

**Text Faults**  
**Table 8–2 (cont)**

FC	XREF	FAULT DESCRIPTION	FAULT NAME	PILOT MSG	LINE MAINT	FAULT TYPE
05	4813	Timing FPGA RAM	FPGA	RADAR FAIL	PULL RTA	POWER ON
	4814	Timing FPGA REG				
	4815	IO FPGA RAM				
	4828	FPGA Download				
	4906	IO FPGA REG				
06	4847	STC Monitor	STC DAC	RADAR FAIL	PULL RTA	POWER ON
07	4830	HVPS Monitor	HVPS MON	RADAR FAIL	PULL RTA	CONTINUOUS
10	4816	DSP RAM	DSP	RADAR FAIL	PULL RTA	POWER ON
	4817	DSP Video RAM				
	4855	DSP Watchdog				CONTINUOUS
	4900	Mailbox Miscompare				POWER ON
	4901	DSP HOLDA Asserted				
	4902	DSP HOLDA Not Asserted				
11	4825	Filament Monitor	MAGNETRON	RADAR FAIL	PULL RTA	LATCHED
	4827	Severe Magnetron				
	4829	PFN Trim Monitor	HVPS MON			CONTINUOUS
12	4831	Pulse Width	PULSE WIDTH	RADAR UNCAL	PULL RTA	CONTINUOUS
13	4832	Elevation Error	EL POSITION	TILT UNCAL	CHK RADOME /RTA	CONTINUOUS
14	4833	Azimuth Error	AZ POSITION	AZIMUTH UNCAL	CHK RADOME /RTA	CONTINUOUS
15	4836	Over TEMP	OVER-TEMP	RADAR CAUTION	PULL RTA	CONTINUOUS
16	4837	XMITTER Power	XMTR POWER	RADAR UNCAL	PULL RTA	CONTINUOUS
20	4839	No SCI Control	NO CNTL IN	CHK CNTL SRC	CHK CNTL SRC	PROBE
	4911	No ARINC 429 Control				

**Text Faults  
Table 8-2 (cont)**

FC	XREF	FAULT DESCRIPTION	FAULT NAME	PILOT MSG	LINE MAINT	FAULT TYPE
21	4840	AGC Limiting	AGC	PICTURE UNCAL	PULL RTA	CONTINUOUS
	4927	AGC RX DAC Monitor		RADAR FAIL		POWER ON
	4928	AGC TX DAC Monitor				
22	4841	Selftest OSC Failure	RCVR SELF-TEST	PICTURE UNCAL	PULL RTA	CONTINUOUS
24	4843	Multiple AFC Unlocks	AFC	SPOKING LIKELY	PULL RTA	CONTINUOUS
	4845	AFC Sweeping				
	4929	AFC RX DAC Monitor		RADAR FAIL		POWER ON
	4930	AFC Trim DAC Monitor				
27	4848	AHRS/IRS Source	NO STAB SRC	STAB UNCAL	CHK ATT SRC	INSTALLATION
	4852	Analog STAB REF				
34	4853	Scan Switch Off	SCAN SWITCH	SCAN SWITCH	CHK SWITCH	INSTALLATION
35	4854	XMIT Switch Off	XMIT SWITCH	XMIT SWITCH	CHK SWITCH	INSTALLATION
36	4914	Invalid Altitude/Airspeed/STAB Strapping	INVALID STRAPS	RADAR UNCAL	CHK STRAPS	POWER ON
	4915	Invalid Controller Source Strapping				
	4916	Config1 Database Version/Size Mismatch	IOP	RADAR FAIL	PULL RTA	

**Text Faults  
Table 8-2**

Table 8–3 describes the pilot messages.

Pilot MSG	Description
RADAR FAIL	The radar is currently inoperable and should not be relied upon. It needs to be replaced or repaired at the next opportunity.
RADAR CAUTION	A failure has been detected that can compromise the calibration accuracy of the radar. Information from the radar should be used only for advisory purposes such as ground mapping for navigation.
PICTURE UNCAL	The radar functions are ok, but receiver calibration is degraded. Color level calibration should be assumed to be incorrect. Have the RTA checked at the next opportunity.
TILT UNCAL	An error in the antenna position system has been detected. The displayed tilt angle setting could be incorrect. This can also cause ground spoking. Have the RTA checked at the next opportunity.
SPOKING LIKELY	A problem has been detected that can cause spoking to occur. Have the system checked at the next opportunity.
STAB UNCAL	An error in the antenna positioning system has been detected. Groundspoking, or excessive ground returns during roll maneuvers can occur. This can be due either to the RTA or the source of pitch and roll information to the RTA.
SCAN SWITCH	The SCAN SWITCH located on the RTA is off, disabling the antenna scan. Check at the next opportunity.
XMIT SWITCH	The XMIT switch located on the RTA is off, disabling the transmitter. Check at the next opportunity.

**Pilot Messages**  
**Table 8–3**



## 9. Honeywell Product Support

Honeywell SPEX® program for corporate operators provides an extensive exchange and rental service that complements a worldwide network of support centers. An inventory of more than 9000 spare components assures that your Honeywell equipped aircraft will be returned to service promptly and economically. This service is available both during and after warranty.

The aircraft owner/operator is required to ensure that units provided through this program have been approved in accordance with their specific maintenance requirements.

All articles are returned to Reconditioned Specifications limits when they are processed through a Honeywell repair facility. All articles are inspected by quality control personnel to verify proper workmanship and conformity to Type Design and to certify that the article meets all controlling documentation. Reconditioned Specification criteria are on file at Honeywell facilities and are available for review. All exchange units are updated with the latest performance reliability MODs on an attrition basis while in the repair cycle.

When contacting a Honeywell Dealer or Customer Support Center for service under the SPEX® program, the following information regarding the unit and the aircraft are required:

- Complete part number with dash number of faulty unit
- Complete serial number of faulty unit
- Aircraft type, serial number and registration number
- Aircraft Owner
- Reported complaint with faulty unit
- Service requested (Exchange or Rental)
- Ship to address
- Purchase order number.
- If faulty unit is IN WARRANTY:
  - Type of warranty (NEW PRODUCT or Exchange)
  - Date warranty started
- If faulty unit is covered under a Maintenance Contract:
  - Type of contract
  - Contract date
  - Plan ID number
- If faulty unit is NOT IN WARRANTY, provide billing address

The Honeywell Support Centers listed below will assist with processing exchange/rental orders.

**24-HOUR EXCHANGE/RENTAL SUPPORT CENTERS**

<b>U.S.A. – DALLAS</b> 800-872-7739 972-402-4300	<b>CANADA – OTTAWA</b> 800-267-9947 613-728-4681
<b>ENGLAND – BASINGSTOKE</b> 44-1256-72-2200	<b>AUSTRALIA – TULLAMARINE</b> 61-3-9330-1411
<b>FRANCE – TOULOUSE</b> 33-0-5-6171-9662	<b>GERMANY – AOA GAUTING</b> 0172-8207300 (in Germany) 49-172-8207300 (outside Germany)
<b>SINGAPORE</b> 65-542-1313	

**CUSTOMER SUPPORT CENTERS – NORTH AMERICA**

**Dallas Support Center**

Honeywell Inc.  
Commercial Aviation Systems  
7825 Ridgepoint Dr.  
IRVING, TX 75063  
TEL: 972-402-4300  
FAX: 972-402-4999

**Minneapolis Support Center**

Honeywell Inc.  
Commercial Aviation Systems  
8840 Evergreen Boulevard  
MINNEAPOLIS, MN 55433-6040  
TEL: 612-957-4051  
FAX: 612-957-4698

**Central Support Center**

Honeywell Inc.  
Commercial Aviation Systems  
1830 Industrial Avenue  
WICHITA, KS 67216  
TEL: 316-522-8172  
FAX: 316-522-2693

**Canada Support Center**

Honeywell Inc.  
Commercial Aviation Systems  
3 Hamilton Avenue North  
OTTAWA, ONTARIO, K1Y 4J4  
TEL: 613-728-4681  
FAX: 613-728-7084

**Ohio Support Center**

Honeywell Inc.  
Commercial Aviation Systems  
8370 Dow Circle  
STRONGSVILLE, OH 44136  
TEL: 440-243-8877  
FAX: 440-243-1954

**Northwest Support Center**

Honeywell Inc.  
Commercial Aviation Systems  
4150 Lind Avenue Southwest  
RENTON, WA 98055  
TEL: 425-251-9511  
TLX: 320033  
FAX: 425-243-1954

## CUSTOMER SUPPORT CENTERS – NORTH AMERICA (CONT)

### Miami Support Center

Honeywell Inc.  
Commercial Aviation Systems  
7620 N.W. 25th Street  
Bldg. C Unit 6  
MIAMI, FL 33122  
TEL: 305-436-8722  
FAX: 305-436-8532

## CUSTOMER SUPPORT CENTERS – REST OF THE WORLD

### United Kingdom Support Center

Honeywell Avionics Systems Ltd  
Edison Road, Ringway North  
BASINGSTOKE, HANTS,  
RG21 6QD  
ENGLAND  
TEL: 44-1256-72-2200  
FAX: 44-1256-72-2201  
AOG: 44-1256-72-2200  
TLX: 51-858067

### France Support Center

Honeywell Aerospace  
1 Rue Marcel-Doret, B.P.14  
31701 BLAGNAC CEDEX,  
FRANCE (Toulouse)  
TEL: 33-5-6212-1500  
FAX: 33-5-6130-0258  
AOG: 33-5-6171-9662  
TLX: 521635F

### Singapore Support Center

Honeywell Aerospace Pte. Ltd.  
2 Loyang Crescent  
SINGAPORE 1750  
TEL: 65-542-1313  
FAX: 65-542-1212  
AOG: 65-542-1313  
TLX: RS 56969 HWLSSC

### Australia Support Center

Honeywell Ltd.  
Trade Park Drive  
TULLAMARINE, 3043, VICTORIA  
AUSTRALIA (Melbourne)  
TEL: 61-3-9330-1411  
FAX: 61-3-9330-3042  
AOG: 61-3-9330-1411  
TLX: 37586 HWLTUL

### Germany Support Center

AOA Apparatebau Gauting GmbH  
Ammerseestrasse 45-49  
D82131 Gauting  
GERMANY  
TEL: 49-89-89317-0  
FAX: 49-89-89317-183  
After Hours AOG Service:  
0172-8207300 (in Germany)  
49-172-8207300 (outside Germany)  
TLX: 0521702

## **PUBLICATION ORDERING INFORMATION**

Additional copies of this manual can be obtained by contacting:

**Honeywell Inc.**  
**P.O. Box 29000**  
**Business and Commuter Aviation Systems**  
**Phoenix, Arizona 85038-9000**  
**Attention: Publication Distribution, Dept. M/S V19A1**

**Telephone No.:** (602) 436-6900  
**FAX:** (602) 436-1588  
**E-MAIL:** CAS-publications distribution@  
CAS.honeywell.com

## 10. Abbreviations

Abbreviations used in this manual are defined as follows:

<b><u>TERMS</u></b>	<b><u>DEFINITION</u></b>
AC	Advisory Circular
ADC	Air Data Computer
AFC	Automatic Flight Control
AGC	Automatic Gain Control
AGL	Above Ground Level
AHRS	Attitude Heading Reference System
API	Antenna Position Indicator
AZ	Azimuth
BITE	Built-in Test Equipment
BRT	Brightness
ccw	Counterclockwise
CHK	Check
CLR	Clear
CNTL	Control
CONFIG	Configuration
CRC	Cyclic Redundancy Check
cw	Clockwise
DAC	Digital to Analog Converter
DSP	Display
EEPROM	Electrically Erasable Programmable Read-Only Memory
EFIS	Electronic Flight Instrument System
EGPWS	Enhanced Ground-Proximity Warning System
EHSI	Electronic Horizontal Situation Indicator
EL	Elevation
FAA	Federal Aviation Administration
FC	Fault Code
FLTPLN, FP, FPLN	Flight Plan
FMS	Flight Management System
FPGA	Field-Programmable Gate Array
FSBY	Forced Standby

**TERMS**

**DEFINITION**

ft	Feet, Foot
GMAP, GMP	Ground Mapping
GPS	Global Positioning System
GSPD	Groundspeed
HOLDA	Hold Acknowledge
HVPS	High Voltage Power Supply
INHIB	Inhibit
INT	Interrupt
IO	Input/Output
IOP	Inoperative
IRS	Inertial Reference System
kt	Knot(s)
LEWP	Line Echo Wave Patterns
LSS, LX	Lightning Sensor System
MAINT	Maintenance
MFD	Multifunction Display
MON	Monitor
MPEL	Maximum Permissible Exposure Level
MSG	Message
N/A	Not Applicable
NAV	Navigation
ND	Navigation Display
NM	Nautical Mile
NSSL	National Severe Storms Laboratory
NWS	National Weather Service
OSC	Oscillator
PFN	Pulse Forming Network
POC	Power on Count
PPI	Plan-Position Indicator
RCT, REACT	Rain Echo Attenuation Compensation Technique
RCVR	Receiver

**TERMS**

**DEFINITION**

REG	Register
RTA	Receiver Transmitter Antenna
RX	Receiver
SBY, STBY	Standby
SCI	Serial Control Interface
SCT, SECT	Scan Sector
SLV	Slave
SPEX	Spares Exchange
STAB, STB	Stabilization
STC	Sensitivity Time Control
TCAS	Traffic Alert and Crew Alerting System
TEMP	Temperature
TERR	Terrain
TGT	Target
TST	Test
TX	Transmitter
UDI	Universal Digital Interface
UNCAL	Uncalibration
VAR	Variance
VIP	Video Integrated Processor
WOW	Weight-on-Wheels
WX	Weather
XMIT, XMITTER, XMTR	Transmitter
XREF	Cross Reference
XSTC	Extended Sensitivity Time Control

## Appendix A

# Federal Aviation Administration (FAA) Advisory Circulars

**NOTE:** This section contains a word-for-word transcription of the contents of the following FAA advisory circulars:

- AC 20-68B
- AC 00-24B.

### **SUBJECT: RECOMMENDED RADIATION SAFETY PRECAUTIONS FOR GROUND OPERATION OF AIRBORNE WEATHER RADAR**

#### **Purpose**

This circular sets forth recommended radiation safety precautions to be taken by personnel when operating airborne weather radar on the ground.

#### **Cancellation**

AC 20-66A, dated April 11, 1975, is cancelled.

#### **Related Reading Material**

Barnes and Taylor, radiation Hazards and Protection (London: George Newnes Limited, 1963), p. 211.

U.S. Department of Health, Education and Welfare, Public Health Service, Consumer Protection and Environmental Health Service, "Environmental health microwaves, ultraviolet radiation, and radiation from lasers and television receivers – An Annotated Bibliography," FS 2.300: RH-35, Washington, U.S. Government Printing Office, pp 56-57.

Mumford, W. W., "Some technical aspects of microwave radiation hazards," Proceedings of the IRE, Washington, U.S. Government Printing Office, February 1961, pp 427-447.

#### **Background**

Dangers from ground operation of airborne weather radar include the possibility of human body damage and ignition of combustible materials by radiated energy. Low tolerance parts of the body include the eyes and the testis.



## Precautions

Management and supervisory personnel should establish procedures for advising personnel of dangers from operating airborne weather radars on the ground. Precautionary signs should be displayed in affected areas to alert personnel of ground testing.

### GENERAL

- Airborne weather radar should be operated on the ground only by qualified personnel.
- Installed airborne radar should not be operated while other aircraft is in the hangar or other enclosure unless the radar transmitter is not operating, or the energy is directed toward an absorption shield which dissipates the radio frequency energy. Otherwise, radiation within the enclosure can be reflected throughout the area.

### BODY DAMAGE

To prevent possible human body damage, the following precautions should be taken:

- Personnel should never stand nearby and in front of a radar antenna which is transmitting. When the antenna is not scanning, the danger increases.
- A recommended safe distance from operating airborne weather radars should be established. A safe distance can be determined by using the equations in Appendix 1 or the graphs of figures 1 and 2. This criterion is now accepted by many industrial organizations and is based on limiting exposure of humans to an average power density not greater than 10 milliwatts per square centimeter.
- Personnel should be advised to avoid the end of an open waveguide unless the radar is turned off.
- Personnel should be advised to avoid looking into a waveguide, or into the open end of a coaxial connector or line connector to a radar transmitter output, as severe eye damage may result.
- Personnel should be advised that when high power radar transmitters are operated out of their protective cases, X-rays may be emitted. Stray X-rays may emanate from the glass envelope type pulser, oscillator, clipper, or rectifier tubes, as well as magnetrons.

## **COMBUSTIBLE MATERIALS**

To prevent possible fuel ignition, an insulated airborne weather radar should not be operated while an aircraft is being refueled or defueled.

M.C. Beard  
Director of Airworthiness.

## **SUBJECT: THUNDERSTORMS**

### **Purpose**

This advisory circular describes the hazards of thunderstorms to aviation and offers guidance to help prevent accidents caused by thunderstorms.

### **Cancellation**

Advisory Circular 00–24A, dated June 23, 1978, is cancelled.

### **Related Reading Material**

Advisory Circulars, 00–6A, Aviation Weather, 090–45B, Aviation Weather Services, 00–50A, Low Level Wind Shear.

### **General**

We all know what a thunderstorm looks like. Much has been written about the mechanics and life cycles of thunderstorms. They have been studied for many years; and while much has been learned, the studies continue because much is not known. Knowledge and weather radar have modified attitudes toward thunderstorms, but one rule continues to be true – any storm recognizable as a thunderstorm should be considered hazardous until measurements have shown it to be safe. That means safe for you and your aircraft. Almost any thunderstorm can spell disaster for the wrong combination of aircraft and pilot.

## Hazards

A thunderstorm packs just about every weather hazard known to aviation into one vicious bundle. Although the hazards occur in numerous combinations, let us look at the most hazardous combination of thunderstorm, the squall line, then we will examine the hazards individually.

### SQUALL LINES

A squall line is a narrow band of active thunderstorms. Often it develops on or ahead of a cold front in moist, unstable air, but it may develop in unstable air far removed from any front. The line may be too long to detour easily and too wide and severe to penetrate. It often contains steady-state thunderstorms and presents the single most intense weather hazard to aircraft. It usually forms rapidly, generally reaching maximum intensity during the late afternoon and the first few hours of darkness.

### TORNADOES

- The most violent thunderstorms draw into their cloud bases with great vigor. If the incoming air has any initial rotating motion, it often forms an extremely concentrated vortex from the surface well into the cloud. Meteorologists have estimated that wind in such a vortex can exceed 200 knots; pressure inside the vortex is quite low. The strong winds gather dust and debris and the low pressure generates a funnel shaped cloud extending downward from the cumulonimbus base. If the cloud does not reach the surface, it is a funnel cloud; if it touches the land surface, it is a tornado.
- Tornadoes occur with both isolated and squall line thunderstorms. Reports for forecasts of tornadoes indicate that atmospheric conditions are favorable for violent turbulence. An aircraft entering a tornado vortex is almost certain to suffer structural damage. Since the vortex extends well into the cloud, any pilot inadvertently caught on instruments in a severe thunderstorm, could encounter a hidden vortex.
- Families of tornadoes have been observed as appendages of the main cloud extending several miles outward from the area of lightning and precipitation. Thus, any cloud connected to a severe thunderstorm carries a threat of violence.

---

## TURBULENCE

- Potentially hazardous turbulence is present in all thunderstorms, and a severe thunderstorm can destroy an aircraft. Strongest turbulence within the cloud occurs with shear between updrafts and downdrafts. Outside the cloud, shear turbulence has been encountered several thousand feet above and 20 miles laterally from a severe thunderstorm. A low level turbulent area is the shear zone associated with the gust front. Often, a roll cloud on the leading edge of a storm marks the top of the eddies in this shear and it signifies an extremely turbulent zone. Gust fronts move far ahead (up to 15 miles) of associated precipitation. The gust front causes a rapid and sometimes drastic change in surface wind ahead of an approaching storm. Advisory Circular 00-50A, "Low Level Wind Shear," explains in greater detail the hazards associated with gust fronts. Figure 1 shows a schematic cross section of a thunderstorm with areas outside the cloud where turbulence may be encountered.
- It is almost impossible to hold a constant altitude in a thunderstorm, and maneuvering in an attempt to do so produces greatly increased stress on the aircraft. It is understandable that the speed of the aircraft determines the rate of turbulence encounters. Stresses are least if the aircraft is held in a constant attitude and allowed to ride the waves. To date, we have no sure way to pick soft spots in a thunderstorm.

## ICING

- Updrafts in a thunderstorm support abundant liquid water with relatively large droplet sizes; and when carried above the freezing level, the water becomes supercooled. When temperature in the upward current cools to about  $-15^{\circ}\text{C}$ , much of the remaining water vapor sublimates as ice crystals; and above this level, at lower temperatures, the amount of supercooled water decreases.
- Supercooled water freezes on impact with an aircraft. Clear icing can occur at any altitude above the freezing level; but at high levels, icing from smaller droplets may be rime or mixed with rime and clear. The abundance of large, supercooled droplets makes clear icing very rapid between  $0^{\circ}\text{C}$  and  $-15^{\circ}\text{C}$  and encounters can be frequent in a cluster of cells. Thunderstorm icing can be extremely hazardous.

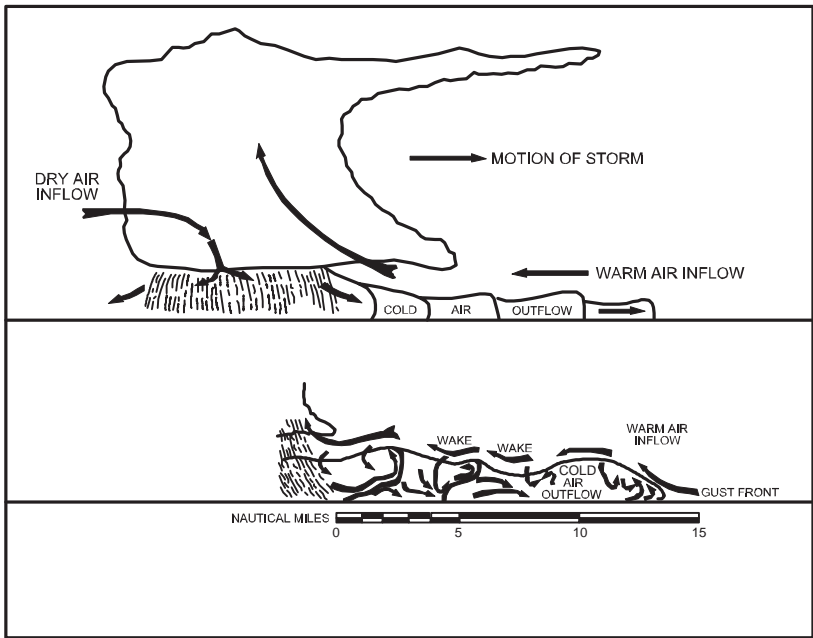

AD-37561@

**Schematic Cross Section of a Thunderstorm  
Figure A-1**

## HAIL

- Hail competes with turbulence as the greatest thunderstorm hazard to aircraft. Supercooled drops above the freezing level begin to freeze. Once a drop has frozen, other drops latch on and freeze to it, so the hailstone grows – sometimes into a huge iceball. Large hail occurs with severe thunderstorms with strong updrafts that have built to great heights. Eventually, the hailstones fall, possibly some distance from the storm core. Hail may be encountered in clear air several miles from dark thunderstorm clouds.
- As hailstones fall through air whose temperature is above 0 °C, they begin to melt and precipitation may reach the ground as either hail or rain. Rain at the surface does not mean the absence of hail aloft. You should anticipate possible hail with any thunderstorm, especially beneath the anvil of a large cumulonimbus. Hailstones larger than one-half inch in diameter can significantly damage an aircraft in a few seconds.

## **LOW CEILING AND VISIBILITY**

Generally, visibility is near zero within a thunderstorm cloud. Ceiling and visibility may also be restricted in precipitation and dust between the cloud base and the ground. The restrictions create the same problem as all ceiling and visibility restrictions; but the hazards are increased many fold when associated with other thunderstorm hazards of turbulence, hail, and lightning which make precision instrument flying virtually impossible.

## **EFFECT ON ALTIMETERS**

Pressure usually falls rapidly with the approach of a thunderstorm, then rises sharply with the onset of the first gust and arrival of the cold downdraft and heavy rain showers, falling back to normal as the storm moves on. This cycle of pressure change may occur in 15 minutes. If the pilot does not receive a corrected altimeter setting, the altimeter may be more than 100 feet in error.

## **LIGHTNING**

A lightning strike can puncture the skin of an aircraft and can damage communication and electronic navigational equipment. Lightning has been suspected of igniting fuel vapors causing explosion; however, serious accidents due to lightning strikes are extremely rare. Nearby lightning can blind the pilot rendering him momentarily unable to navigate by instrument or by visual reference. Nearby lightning can also induce permanent errors in the magnetic compass. Lightning discharges, even distant ones, can disrupt radio communications on low and medium frequencies. Though lightning intensity and frequency have no simple relationship to other storm parameters, severe storms, as a rule, have a high frequency of lightning.

## **WEATHER RADAR**

Weather radar detects droplets of precipitation size. Strength of the radar return (echo) depends on drop size and number. The greater the number of drops, the stronger is the echo, and the larger the drops, the stronger is the echo. Drop size determines echo intensity to a much greater extent than does drop number. Hailstones usually are covered with a film of water and, therefore, act as huge water droplets giving the strongest of all echoes.

Numerous methods have been used in an attempt to categorize the intensity of a thunderstorm. To standardize thunderstorm language between weather radar operators and pilots, the use of Video Integrator Processor (VIP) levels is being promoted.

The National Weather Service (NWS) radar observer is able to objectively determine storm intensity levels with VIP equipment. These radar echo intensity levels are on a scale of one to six. If the maximum VIP levels are 1 "weak" and 2 "moderate," then light to moderate turbulence is possible with lightning. VIP Level 3 is strong and severe turbulence is possible with lightning. VIP Level 4 is very strong and severe turbulence is likely with lightning. VIP Level 5 is intense with severe turbulence, lightning, hail likely, and organized surface wind gusts. VIP Level 6 is extreme with severe turbulence, lightning, large hail, extensive wind gusts, and turbulence.

Thunderstorms build and dissipate rapidly. Therefore, do not attempt to plan a course between echoes. The best use of ground radar information is to isolate general areas and coverage of echoes. You must avoid individual storms from in-flight observations either by visual sighting or by airborne radar. It is better to avoid the whole thunderstorm area than to detour around individual storms unless they are scattered.

Airborne weather avoidance radar is, as its name implies, for avoiding severe weather – not for penetrating it. Whether to fly into an area of radar echoes depends on echo intensity, spacing between the echoes, and the capabilities of you and your aircraft. Remember that weather radar detects only precipitation drops; it does not detect turbulence. Therefore, the radar scope provides no assurance of avoidance turbulence. The radar scope also does not provide assurance of avoiding instrument weather from clouds and fog. Your scope may be clear between intense echoes; this clear does not mean you can fly.

Remember that while hail always gives a radar echo, it may fall several miles from the nearest cloud and hazardous turbulence may extend to as much as 20 miles from the echo edge. Avoid intense or extreme level echoes by at least 20 miles; that is, such echoes should be separated by at least 40 miles before you fly between them. With weaker echoes you can reduce the distance by which you avoid them.

## **DO'S AND DON'TS OF THUNDERSTORM FLYING**

Above all, remember this: Never regard any thunderstorm lightly even when radar observers report the echoes are of light intensity. Avoiding thunderstorms is the best policy. Following are some do's and don'ts of thunderstorm avoidance:

- Don't land or take off in the face of an approaching thunderstorm. A sudden gust front of low level turbulence could cause loss of control.

- Don't attempt to fly under a thunderstorm even if you can see through to the other side. Turbulence and wind shear under the storm could be disastrous.
- Don't fly without airborne radar into a cloud mass containing scattered embedded thunderstorms. Scattered thunderstorms not embedded, usually can be visually circumnavigated.
- Don't trust the visual appearance to be a reliable indicator of the turbulence inside a thunderstorm.
- Do avoid, by at least 20 miles, any thunderstorm identified as severe or giving an intense radar echo. This is especially true under the anvil of a large cumulonimbus.
- Do circumnavigate the entire area if the area has 6/1 thunderstorm coverage.
- Do remember that vivid and frequent lightning indicates the probability of a severe thunderstorm.
- Do regard as extremely hazardous, any thunderstorm with tops 35,000 feet or higher, whether the top is visually sighted or determined by radar.

If you cannot avoid penetrating a thunderstorm, the following are some do's BEFORE entering the storm.

- Tighten your safety belt, put on your shoulder harness if you have one, and secure all loose objects.
- Plan and hold your course to take you through the storm in a minimum time.
- To avoid the most critical icing, establish a penetration altitude below the freezing level or above the level of  $-15^{\circ}\text{C}$ .
- Verify that pitot heat is on and turn on carburetor heat or jet engine anti-ice. Icing can be rapid at any altitude and cause almost instantaneous power failure and/or loss of airspeed indication.
- Establish power settings for turbulence penetration airspeed recommended in your aircraft manual.
- Turn up cockpit lights to highest intensity to lessen temporary blindness from lightning.
- If using automatic pilot, disengage altitude hold mode and speed hold mode. The automatic altitude and airspeed controls of the aircraft increase maneuvers, thus increasing structural stress.



- If using airborne radar, tilt the antenna up and down occasionally. This will permit you to detect other thunderstorm activity at altitudes other than the one being flown.

Following are some do's and don'ts during thunderstorm penetration.

- Do keep your eyes on your instruments. Looking outside the cockpit can increase danger of temporary blindness from lightning.
- Don't change power settings; maintain settings for the recommended turbulence penetration airspeed.
- Do maintain constant attitude; let the aircraft ride the waves. Maneuvers in trying to maintain constant altitude increase stress on the aircraft.
- Don't turn back once you are in a thunderstorm. A straight course through the storm most likely will get you out of the hazards most quickly. In addition, turning maneuvers increase stress on the aircraft.

## **National Severe Storms Laboratory (NSSL) Thunderstorm Research**

The NSSL has, since 1964, been the focal point of our thunderstorm research. In-flight conditions obtained from thunderstorm penetration by controlled, especially equipped high performance aircraft are compared by the NSSL with National Weather Service (NWS) type ground-based radar and with newly developed doppler radar. The following comments are based on NSSL's interpretation of information and experience from this research.

### **RELATIONSHIP BETWEEN TURBULENCE AND REFLECTIVITY**

Weather radar reflects precipitation such as rain and hail. It has been found, however, that the intensity level of the precipitation reflection does correlate with the degree of turbulence in a thunderstorm. The most severe turbulence is not necessarily found at the same place that gives the greatest radar reflection.

### **RELATIONSHIP BETWEEN TURBULENCE AND ALTITUDE**

The NSSL studies of thunderstorms extending to 60,000 feet show little variation of turbulence intensity with altitude.

---

## **TURBULENCE AND ECHO INTENSITY ON NWS RADAR (WSR-57)**

The frequency and severity of turbulence increases with radar reflectivity, a measure of the intensity of echoes from storm targets at a standard range. Derived gust velocities exceeding 2,100 feet per minute (classified as severe turbulence) are commonly encountered in level 3 storms. In level 2 storms, gusts of intensity between 1,200 and 2,100 feet per minute (classified as moderate turbulence) are encountered approximately once for each 10 nautical miles of thunderstorm flight.

## **TURBULENCE IN RELATION TO DISTANCE FROM STORM CORE**

NSSL data indicates that the frequency and severity of turbulence encounters decrease slowly with distance from storm cores. Significantly, the data indicates that within 20 miles from the center of severe storm cores, moderate to severe turbulence is encountered at any altitude about one-fifth as often as in the cores of Level 3 or greater thunderstorms. Further, the data indicates that moderate turbulence is encountered at any altitude up to 10 miles from the center of level 2 thunderstorms. SEVERE TURBULENCE IS OFTEN FOUND IN TENUOUS ANVIL CLOUDS 15 TO 20 MILES DOWNWIND FROM SEVERE STORM CORES. Our findings agree with meteorological reasoning that THE STORM CLOUD IS ONLY THE VISIBLE PORTION OF A TURBULENT SYSTEM WHOSE UPDRAFTS AND DOWN-DRAFTS OFTEN EXTEND OUTSIDE OF THE STORM PROPER.

## **TURBULENCE IN RELATION TO DISTANCE FROM THE STORM EDGE**

THE CLEAR AIR ON THE INFLOW SIDE OF A STORM IS A PLACE WHERE SEVERE TURBULENCE OCCURS. At the edge of a cloud, the mixing of cloudy and clear air often produces strong temperature gradients associated with rapid variation of vertical velocity. Tornado activity is found in a wide range of spacial relationships to the strong echoes with which they are commonly associated, but many of the most intense and enduring tornadoes occur on the south to west edges of severe storms. The tornado itself is often associated with only a weak echo. Echo hooks and appendages are useful qualitative indicators of tornado occurrence but are by no means infallible guides. Severe turbulence should be anticipated up to 20 miles from the radar edge of severe storms; these often have a well-defined radar echo boundary. The distance decreases to approximately 10 miles with weaker storms which may sometimes have indefinite radar echo boundaries. THEREFORE, AIRBORNE RADAR IS A PARTICULARLY USEFUL AID FOR PILOTS IN MAINTAINING A SAFE DISTANCE FROM SEVERE STORMS.

## **TURBULENCE ABOVE STORM TOPS**

Flight data shows a relationship between turbulence above storm tops and the airspeed of upper tropospheric winds. WHEN THE WINDS AT STORM TOP EXCEED 100 KNOTS, THERE ARE TIMES WHEN SIGNIFICANT TURBULENCE MAY BE EXPERIENCED AS MUCH AS 10,000 FEET ABOVE THE CLOUD TOPS. THIS VALUE MAY BE DECREASED 1,000 FEET FOR EACH 10-KNOT REDUCTION OF WIND SPEED. This is especially important for clouds whose height exceeds the height of the tropopause. It should be noted that flight above severe thunderstorms is an academic consideration for today's civil aircraft in most cases, since these storms usually extend up to 40,000 feet and above.

## **TURBULENCE BELOW CLOUD BASE**

While there is little evidence that maximum turbulence exists at middle heights in storms (FL 200–300), turbulence beneath a storm is not to be minimized. This is especially true when the relative humidity is low in any air layer between the surface and 15,000 feet. Then the lower altitudes may be characterized by strong outflowing winds and severe turbulence where thunderstorms are present. Therefore, THE SAME TURBULENCE CONSIDERATIONS WHICH APPLY TO FLIGHT AT HIGH ALTITUDES NEAR STORMS APPLY TO LOW LEVELS AS WELL.

## **MAXIMUM STORM TOPS**

Photographic data indicates that the maximum height attained by thunderstorm clouds is approximately 63,000 feet. Such very tall storm tops have not been explored by direct means, but meteorological judgments indicate the probable existence of large hail and strong vertical drafts to within a few thousand feet of the top of these isolated stratosphere-penetrating storms. THEREFORE, IT APPEARS IMPORTANT TO AVOID SUCH VERY TALL STORMS AT ALL ALTITUDES.

## **HAIL IN THUNDERSTORMS**

The occurrence of HAIL IS MUCH MORE CLEARLY IDENTIFIED WITH THE INTENSITY OF ECHOES THAN IS TURBULENCE. AVOIDANCE OF MODERATE AND SEVERE STORMS SHOULD ALWAYS BE ASSOCIATED WITH THE AVOIDANCE OF DAMAGING HAIL.

## **VISUAL APPEARANCE OF STORM AND ASSOCIATED TURBULENCE WITH THEM**

On numerous occasions, flight at NSSL have indicated that NO USEFUL CORRELATION EXISTS BETWEEN THE EXTERNAL VISUAL APPEARANCE OF THUNDERSTORMS AND THE TURBULENCE AND HAIL WITHIN THEM.

## **MODIFICATION OF CRITERIA WHEN SEVERE STORMS AND RAPID DEVELOPMENT ARE EVIDENT**

During severe storm situations, radar echo intensities may grow by a factor of ten each minute, and cloud tops by 7,000 feet per minute. THEREFORE, NO FLIGHTPATH THROUGH A FIELD OF STRONG OR VERY STRONG STORMS SEPARATED BY 20–30 MILES OR LESS MAY BE CONSIDERED TO REMAIN FREE FROM SEVERE TURBULENCE.

## **EXTRAPOLATION TO DIFFERENT CLIMBS**

General comment: Severe storms are associated with an atmospheric stratification marked by large values of moisture in low levels, relative dryness in middle levels, and strong wind shear. It is well known that this stratification of moisture permits excessive magnitudes of convective instability to exist for an indefinite period until rapid overturning of air is triggered by a suitable disturbance. Regions of the atmosphere which are either very dry or very moist throughout substantial depths cannot harbor great convective instability. Rather, a more nearly neutral thermal stratification is maintained, partially through a process of regular atmospheric overturning.

- **Desert Areas** – In desert areas, storms should be avoided on the same basis as described in the above paragraphs. While nonstorm turbulence may, in general, be expected more frequently over desert areas during daylight hours than elsewhere, THE SAME TURBULENCE CONSIDERATIONS PREVAIL IN THE VICINITY OF THUNDERSTORMS.
- **Tropical–Humid Climates** – When the atmosphere is moist and only slightly unstable though a great depth, strong radar echoes may be received from towering clouds which do not contain vertical velocities as strong as those from storms over the U.S. plains. Then it is a matter of the pilot being informed with respect to the general atmospheric conditions accompanying storms, for it is well known that PRACTICALLY ALL GEOGRAPHIC AREAS HAVING THUNDERSTORMS ARE OCCASIONALLY VISITED BY SEVERE ONES.

## **USE OF AIRBORNE RADAR**

Airborne radar is a valuable tool; HOWEVER, ITS USE IS PRINCIPALLY AS AN INDICATOR OF STORM LOCATIONS FOR AVOIDANCE PURPOSES WHILE ENROUTE.

## Appendix B

# Enhanced Ground–Proximity Warning System (EGPWS)

The AlliedSignal Mark VII EGPWS combines information from aircraft navigation equipment (i.e. flight management system (FMS), inertial reference system (IRS), global positioning system (GPS), radio altimeter) with a stored terrain data base that alerts the pilot to potentially dangerous ground proximity.

In addition to the verbal alert, the EGPWS can display the terrain data on the weather radar indicator. Depending on the installation, the pilot pushes a button to display the terrain, or the terrain data is automatically displayed when a **Terrain Alert** occurs.

## SYSTEM OPERATION

To display the EGPWS, the weather system can be in any mode except OFF. When the EGPWS is active, the indicator range up and down arrows control the EGPWS display range. The AŽ button on the indicator is also active and the azimuth lines can be displayed or removed.

The other radar controls do not change the terrain display, but if they are used while the EGPWS is displayed, they control the radar receiver transmitter antenna (RTA), and the effect is displayed when the system returns to the radar display.

## EGPWS Controls

The typical EGPWS installation has remotely mounted push button controls and status annunciators that are related to the display on the radar indicator. The paragraphs below give a functional description of the AlliedSignal recommended controls.

## PUSH BUTTON CONTROLS

The following remotely mounted push buttons control the EGPWS display:

- **INHIB (Inhibit) Button** – When active, the push on/push off INHIB button prevents terrain data from being displayed on the radar indicator. When the button is active, the INHIB annunciator lights.
- **ON (Terrain) Button** – When active, the push on/push off ON button displays terrain on the radar indicator.

## ANNUNCIATORS

The following annunciators are displayed on the radar indicator to indicate EGPWS operation:

- **FAIL** – The FAIL annunciator indicates that the EGPWS has failed.
- **INHIB** – The INHIB annunciator indicates that the INHIB push button has been pushed and is active. When INHIB is annunciated, EGPWS is not displayed on the radar indicator, and the aural annunciators do not sound.

**NOTE:** The FAIL and INHIB annunciators are often incorporated into the INHIB push button.

- **TERR (Terrain)** – The TERR annunciator indicates that the annunciator lamp power is on. It does not indicate the operational status of the system.
- **ON** – The ON annunciator indicates that the radar indicator is displaying terrain. This ON push button lamp is lit if the ON push button has been pushed and is active, or if an actual **Terrain Alert** is indicated by the EGPWS system and the terrain is automatically displayed.

**NOTE:** The TERR and ON annunciators are often incorporated into the ON push button.

Some installation may not contain all of these controls and annunciators, or they may have different names. Most EGPWS installations have additional controls and/or annunciators (i.e., TEST). Refer to the appropriate AlliedSignal publication for details.

## Related EGPWS System Operation

Some installations may have a DATA–NAV (navigation display, and/or checklist), lightning sensor system (LSS), and/or traffic alert and crew alerting system (TCAS) that already share the radar indicator's display by way of the Universal Digital Interface (UDI) connector. These systems have priority for access to the radar display screen. These systems data may be overlaid on the EGPWS display, or they may simply override the EGPWS display.

## EGPWS Operation

The EGPWS system may vary, depending on the installed controls and software level of the EGPWS computer.

In some installations, the EGPWS display on the radar indicator is manually operated. It is only displayed if the pilot pushes the ON button, and it is removed if the pilot pushes the ON button a second time.

In some installations, the EGPWS display has a **pop–up** mode in which the terrain display is automatically displayed when the EGPWS system detects a **terrain alert** situation.

The pilot can remove the ground display from the radar indicator, or prevent the EGPWS system from displaying ground on the radar indicator by pushing the INHIB button.

The ↑ and ↓ range buttons on the radar indicator control the range of the ground display. The radar indicator AZ button is active, and can display or remove azimuth buttons. The other radar controls do not change the ground display, but if they are used while EGPWS is displayed, they control the radar RTA and the effects of any changes are seen when the radar image is re–displayed.

For additional information, refer to the appropriate AlliedSignal EGPWS operating manual.

## EGPWS Display

The EGPWS displays is shown as variable dot patterns in **green**, **yellow**, or **red**. The density and color is a function of how close the terrain is relative to the aircraft altitude above ground level (AGL), refer to table B-1. Terrain/obstacle alerts are shown by painting the threatening terrain as solid or **red**. Terrain that is more than 2000 feet below the aircraft is not displayed. Areas where terrain data is not available are shown in **magenta**..

Elevation of Terrain in Feet AGL	Color
2000 or more above the aircraft	High density <b>red</b>
1000 – 2000 above the aircraft	High density <b>yellow</b> dot pattern
0–1000 above the aircraft	Medium Density <b>yellow</b> Dot Pattern
0–1000 below the aircraft	Medium density <b>green</b> dot pattern
1000 – 2000 below the aircraft	Low density <b>green</b> dot pattern
2000 or more below the aircraft	<b>black</b>
Unknown terrain	<b>Magenta</b>
<b>NOTE:</b> Caution terrain (60 second warning) is displayed as <b>solid yellow</b> . Warning obstacle (30 second warning) is displayed as <b>solid red</b> .	

**EGPWS Obstacle Display Color Definitions**  
**Table B-1**



Figure B-1 shows the EGPWS over KPHX airport at 2000 feet mean sea level heading north. The terrain shows the mountains to the north of Phoenix.

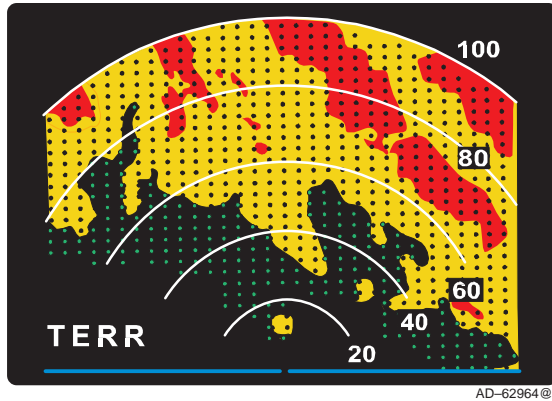

**EHSI Display Over KPHX Airport  
With the EGPWS Display  
Figure B-1**

## EGPWS Test

When the EGPWS is selected for display, it can be tested. Push the remote mounted EGPWS TEST button to display the test format shown in figure B-2.

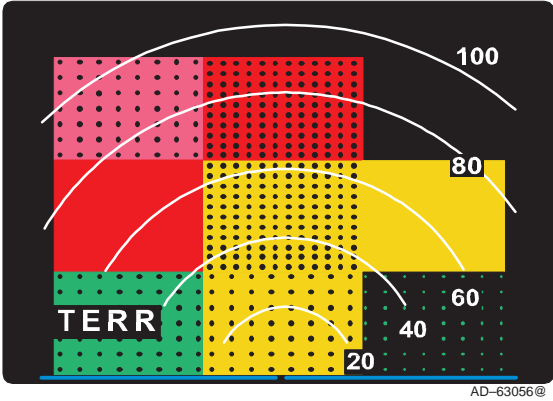

**EGPWS Test Display**  
**Figure B-2**

# Index

## A

- Abbreviations, 10-1
- Accelerative Error, 5-15
- Additional hazards, 5-55
  - turbulence versus distance from storm core, 5-55
  - turbulence versus distance from storm edge, 5-55
- Altitude, A-10
  - relationship between turbulence and altitude, A-10
- Antenna mounting error, 5-16
  - level flight stabilization check, 5-17
  - stabilization in straight and level flight check procedure, 5-17
- Azimuth resolution, 5-41

## C

- Cockpit mounted equipment, 2-4
- Configurations of individual echoes (northern hemisphere), 5-47
  - avoid all crescent shaped echoes by 20 miles, 5-51
  - avoid hook echoes by 20 miles, 5-47
  - avoid pendant by 20 miles, 5-50
  - avoid steep rain gradients by 20 miles, 5-51
  - avoid V-notch by 20 miles, 5-49
- Customer support centers , 9-2
  - North America, 9-2
  - Rest of the World, 9-3

## D

- Do's and don'ts of thunderstorm flying, A-8
- Dynamic Error, 5-15

## E

- Effect on altimeters, A-7
- Enhanced ground-proximity warning system (EGPWS), B-1
  - annunciators, B-2
    - FAIL, B-2
    - INHIB, B-2
    - ON, B-2
    - TERR, B-2
  - displays, B-4
    - obstacle display color definitions, B-4
  - EGPWS test, B-6
  - push buttons controls, B-2
    - INHIB button, B-2
    - ON (terrain) button, B-2
  - system operation, B-1
    - controls, B-1
    - EGPWS operation, B-3
    - related EGPWS system operation, B-3
- Equipment list, 2-4
  - cockpit mounted options, 2-4
  - remote mounted, 2-4
- Errors, 5-15
  - accelerative, 5-15
  - antenna mounting error, 5-16
    - level flight stabilization check, 5-17
  - dynamic, 5-15
  - pitch gain, 5-22
    - pitch stabilization check, 5-22
  - roll gain, 5-19
    - roll stabilization (while turning) check, 5-19
    - stabilization in turns check procedure, 5-19
  - wallowing (wing walk and yaw), 5-19
- Exchange and rental service, 9-1
- Extrapolation to different climbs, A-13
  - desert areas, A-13
  - tropical-humid climates, A-13

## Index (cont)

### F

- Fault code and text fault relationships, 8-5
  - pilot messages, 8-8
- Federal Aviation Administration (FAA) Advisory Circulars
  - recommended radiation safety precautions for ground operation of airborne weather radar, A-1
    - background, A-1
    - cancellation, A-1
    - precautions, A-2
    - purpose, A-1
    - related reading material, A-1
- Thunderstorms, A-3
  - cancellation, A-3
  - general, A-3
  - hazards, A-4
  - national severe storms laboratory (NSSL)
    - thunderstorm research, A-10
  - purpose, A-3
  - related reading material, A-3

### G

- Gain adjustment, 7-11
  - pitch, 7-15
    - adjustment procedure, 7-15
  - roll, 7-11
    - adjustment procedure, 7-11
- Ground mapping, 5-56
  - TILT setting for maximal ground target display, 5-57
    - 12-inch radiator, 5-57
    - 18-inch radiator, 5-58

### H

- Hail, A-6
- Hail in thunderstorms, A-12

- Hail size probability, 5-36
- Honeywell product support, 9-1
  - customer support centers, 9-2,
    - North America, 9-2
    - Rest of the World, 9-3
  - publication ordering information, 9-4

### I

- Icing, A-5
- In-flight adjustments, 7-1
  - pitch and roll trim adjustments, 7-1
    - level flight stabilization check, 7-3
  - pitch gain adjustment, 7-15
    - adjustment procedure, 7-15
  - pitch offset adjustment, 7-8
    - adjustment procedure, 7-8
  - pitch stabilization check, 7-12
    - check procedure, 7-12
  - roll gain adjustment, 7-11
    - adjustment procedure, 7-11
  - roll offset adjustment, 7-5
    - adjustment procedure, 7-5
  - roll stabilization check, 7-9
    - while turning check procedure, 7-9
- in-flight troubleshooting, 8-1
  - fault code and text fault relationships, 8-1, 8-5
    - pilot messages, 8-8
  - pilot event marker, 8-1, 8-4
  - test mode with TEXT FAULTS
    - enabled, 8-2
      - fault data fields, 8-2
- Interpreting weather radar images, 5-24
  - radar and visual cloud mass, 5-26
  - squall line, 5-27
  - weather radar images, 5-24
- Introduction, 1-1

## Index (cont)

### L

- Level flight stabilization check, 5-17, 7-3
  - stabilization in straight and level flight check procedure, 5-17, 7-3
- Lightning, A-7
- Line configurations, 5-52
  - avoid bow-shaped line of echoes by 20 miles, 5-54
  - avoid line echo wave patterns (LEWP) by 20 miles, 5-53
  - avoid thunderstorm echoes at the south end of a line or at a break in a line by 20 miles, 5-52
- Low ceiling and visibility, A-7

### M

- Maximum permissible exposure level (MPEL), 6-1
- Maximum storm tops, A-12
- Modification of criteria when severe storms and rapid development are evident, A-13

### N

- National severe storms laboratory (NSSL) thunderstorm research, A-10
  - extrapolation to different climbs, A-13
    - desert areas, A-13
    - tropical-humid climates, A-13
  - hail in thunderstorms, A-12
  - maximum storm tops, A-12
  - modification of criteria when severe storms and rapid development are evident, A-13
  - relationship between turbulence and altitude, A-10

- relationship between turbulence and reflectivity, A-10
- turbulence above storm tops, A-11
- turbulence and echo intensity on NWS radar (WSR-57), A-11
- turbulence below cloud base, A-12
- turbulence in relation to distance from storm core, A-11
- turbulence in relation to distance from the storm edge, A-11
- use of airborne radar, A-13
- visual appearance of storm and associated turbulence with them , A-12

- Normal operation, 4-1
  - preliminary control settings, 4-1
  - power-up procedure, 4-1
  - radar mode — ground mapping, 4-5
  - radar mode — weather, 4-4
  - standby, 4-4
- test mode, 4-6
  - color bands, 4-6
  - dedicated radar indicator, 4-6
  - EFIS/MFD/ND, 4-6

### O

- Offset adjustment, 7-5
  - pitch, 7-8
    - adjustment procedure, 7-8
  - roll, 7-5
    - adjustment procedure, 7-5
- Operating controls, 3-1
  - weather radar controller operation, WC-660, 3-10
  - GAIN, 3-16
  - LSS (lightning sensor system) (optional), 3-13
  - RADAR, 3-14
  - rainfall rate color coding, 3-14
  - RANGE, 3-11

## Index (cont)

weather radar controller  
 operation, WC-660 (cont)  
   RCT (rain echo attenuation  
   compensation technique  
   (React)), 3-11  
   SECT (scan sector), 3-12  
   SLV (slave) (dual installations  
   only), 3-13  
   STAB (stabilization), 3-11  
   target alert characteristics,  
   3-12  
   TGT (target), 3-12  
   TILT, 3-13  
 weather radar indicator operation,  
 WI-650/660, 3-1  
   AZ (azimuth), 3-9  
   BRT (brightness) or BRT/LSS  
   (lightning sensor  
   system), 3-9  
   display area, 3-5  
   function switch, 3-5  
   GAIN, 3-8  
   GMP (ground mapping)  
   button MAP, 3-2  
   Rainfall rate color coding, 3-6  
   RANGE, 3-9  
   RCT (rain echo attenuation  
   compensation technique  
   (React)), 3-3  
   SCT (scan sector), 3-9  
   target alert characteristics,  
   3-4  
   TGT (target), 3-4  
   TILT, 3-8  
   WX (weather) button, 3-2

## P

Pilot event marker, 8-4  
 Pitch and roll trim adjustments, 7-1  
   level flight stabilization check, 7-3  
 Pitch gain adjustment, 7-15  
   adjustment procedure, 7-15  
 Pitch gain error, 5-22

  pitch stabilization check, 5-22  
 Pitch offset adjustment, 7-8  
   adjustment procedure, 7-8  
 Pitch stabilization check, 7-12  
   check procedure, 7-12  
 Preliminary control settings, 4-1  
   power-up procedure, 4-1  
   radar mode – ground mapping,  
   4-5  
   radar mode – weather, 4-4  
   standby, 4-4  
 Procedures  
   in-flight roll offset adjustment, 7-5  
   pitch gain adjustment, 7-15  
   pitch offset adjustment, 7-8  
   pitch stabilization check, 7-12  
   power-up, 4-1  
   roll gain adjustment, 7-11  
   roll stabilization (while turning)  
   check, 7-9  
   severe weather avoidance, 5-43  
   stabilization in straight and level  
   flight check, 5-17, 7-3  
   stabilization in turns check, 5-19  
 Publication ordering information, 9-4

## R

Radar facts  
   ground mapping, 5-56  
     TILT setting for maximal  
     ground target display, 5-57  
   interpreting weather radar  
   images, 5-24  
     radar and visual cloud mass,  
     5-26  
     squall line, 5-27  
     weather radar images, 5-24  
 radar operation, 5-1  
   phenomenas, 5-4  
 radome, 5-42  
 rain echo attenuation  
   compensation technique  
   (react), 5-31

## Index (cont)

- azimuth resolution, 5-41
  - hail size probability, 5-36
  - shadowing, 5-34
  - spotting hail, 5-37
  - turbulence probability, 5-34
  - stabilization, 5-15
    - accelerative error, 5-15
    - antenna mounting error, 5-16
    - dynamic error, 5-15
    - pitch gain error, 5-22
    - roll gain error, 5-19
    - wallowing (wing walk and yaw) error, 5-19
  - tilt management, 5-5
    - tilt setting for minimal ground target display, 5-8
  - variable gain control, 5-30
  - weather avoidance, 5-43
    - additional hazards, 5-55
    - configurations of individual echoes (northern hemisphere), 5-47
    - line configurations, 5-52
    - severe weather avoidance procedures, 5-43
    - weather display calibration, 5-28
  - Radiation Safety Precautions, A-1
  - Radome, 5-42
  - Rain echo attenuation
    - compensation technique (REACT), 5-31
      - related functions, 5-31
        - attenuation compensation, 5-31
        - cyan REACT field, 5-31
  - Recommended radiation safety precautions for ground operation of airborne weather radar, A-1
    - background, A-1
    - cancellation, A-1
    - precautions, A-2
      - body damage, A-2
      - combustible materials, A-3
      - general, A-2
    - purpose, A-1
      - related reading material, A-1
  - Reflectivity, A-10
    - relationship between turbulence and reflectivity, A-10
  - Relationship between turbulence and altitude, A-10
  - Remote mounted equipment, 2-4
  - Roll gain adjustment, 7-11
    - adjustment procedure, 7-11
  - Roll offset adjustment, 7-5
    - adjustment procedure, 7-5
  - Roll stabilization check, 7-9
    - while turning check procedure, 7-9
- 
- ## S
- Shadowing, 5-34
  - Spotting hail, 5-37
  - Squall lines, A-4
  - Stabilization, 5-15
    - accelerative error, 5-15
    - antenna mounting error, 5-16
      - level flight stabilization check, 5-17
    - dynamic error, 5-15
    - pitch gain error, 5-22
      - pitch stabilization check, 5-22
    - roll gain error, 5-19
      - roll stabilization (while turning) check, 5-19
    - wallowing (wing walk and yaw) error, 5-19
  - Stabilization check, 7-9
    - Pitch, 7-12
      - Check procedure, 7-12
    - Roll, 7-9
      - While turning check procedure, 7-9
  - Support centers, 9-2
    - customer support centers, 9-2
      - North America, 9-2
      - Rest of the World, 9-3
    - 24-hour exchange/rental support centers, 9-2

## Index (cont)

System configurations, 2-1  
 dual configuration, 2-1  
 dual control mode truth table, 2-3  
 equipment list, 2-4  
     cockpit mounted options, 2-4  
     remote mounted, 2-4  
 stand-alone, 2-1

## T

Test mode, 4-6  
 color bands, 4-6  
 dedicated radar indicator, 4-6  
 EFIS/MFD/ND, 4-6  
 Test mode with TEXT FAULTS  
 enabled, 8-2  
 Thunderstorms, A-3  
 Cancellation, A-3  
 general, A-3  
 hazards, A-4  
     do's and don'ts of  
     thunderstorm flying, A-8  
     effect on altimeters, A-7  
     hail, A-6  
     icing, A-5  
     lightning, A-7  
     low ceiling and visibility, A-7  
     schematic cross section of a  
     thunderstorm, A-6  
     squall lines, A-4  
     tornadoes, A-4  
     turbulence, A-5  
     weather radar, A-7  
 national severe storms laboratory  
 (NSSL) thunderstorm research,  
 A-10  
     extrapolation to different  
     climbs, A-13  
     hail in thunderstorms, A-12  
     maximum storm tops, A-12  
     modification of criteria when  
     severe storms and rapid  
     development are evident,  
     A-13

relationship between  
 turbulence and altitude,  
 A-10  
 relationship between  
 turbulence and reflectivity,  
 A-10  
 turbulence above storm tops,  
 A-11  
 turbulence and echo intensity  
 on NWS radar (WSR-57),  
 A-11  
 turbulence below cloud base,  
 A-12  
 turbulence in relation to  
 distance from the storm  
 edge, A-11  
 turbulence in relation to  
 distance from storm core,  
 A-11  
 use of airborne radar, A-13  
 visual appearance of storm  
 and associated turbulence  
 with them, A-12  
 purpose, A-3  
 related reading material, A-3  
 Tilt management, 5-5  
     tilt setting for minimal ground  
     target display, 5-8  
     12-inch radiator, 5-8  
     18-inch radiator, 5-9  
 Tornadoes, A-4  
 Trim adjustments, 7-1  
 Turbulence  
     above storm tops, A-11  
     and echo intensity on NWS radar  
     (WSR-57), A-11  
     below cloud base, A-12  
     in relation to distance from storm  
     core, A-11  
     in relation to distance from the  
     storm edge, A-11  
     relationship between turbulence  
     and altitude, A-10  
     relationship between turbulence  
     and reflectivity, A-10



## Index (cont)

- versus distance from storm core, 5-55
  - versus distance from storm edge, 5-55
  - visual appearance of storm and associated turbulence with them , A-12
  - Turbulence probability, 5-34
    - turbulence levels (from airman's information manual), 5-36
  - 24-hour exchange/rental support centers, 9-2
- 
- U**
- Use of airborne radar, A-13
- 
- V**
- Variable gain control, 5-30
  - Visual appearance of storm and associated turbulence with them , A-12
- 
- W**
- Wallowing (wing walk and yaw) error, 5-19
  - Warranty, 9-1
  - Weather avoidance, 5-43
    - additional hazards, 5-55
      - turbulence versus distance from storm core, 5-55
      - turbulence versus distance from storm edge, 5-55
    - configurations of individual echoes (northern hemisphere), 5-47
      - avoid all crescent shaped echoes by 20 miles, 5-51
      - avoid hook echoes by 20 miles, 5-47
      - avoid pendant by 20 miles, 5-50
      - avoid steep rain gradients by 20 miles, 5-51
      - avoid v-notch by 20 miles, 5-49
    - line configurations, 5-52
      - avoid bow-shaped line of echoes by 20 miles, 5-54
      - avoid line echo wave patterns (LEWP) by 20 miles, 5-53
      - avoid thunderstorm echoes at the south end of a line or at a break in a line by 20 miles, 5-52
    - severe weather avoidance procedures, 5-43
  - Weather display calibration, 5-28
  - Weather radar, A-7
  - Weather radar controller operation, WC-660, 3-10
    - GAIN, 3-16
    - LSS (lightning sensor system) (optional), 3-13
      - CLR/TST (clear/test), 3-13
      - LX (lightning sensor system), 3-13
    - OFF, 3-13
    - SBY (standby), 3-13
  - RADAR, 3-14
    - FP (flight plan), 3-15
    - GMAP (ground mapping), 3-14
    - OFF, 3-14
    - rainfall rate color coding, 3-14
    - STBY (standby), 3-14
    - TST (test), 3-15
    - WX (weather), 3-14
  - RANGE, 3-11
  - RCT (rain echo attenuation compensation technique (REACT)), 3-11
  - SECT (scan sector), 3-12

## Index (cont)

Weather radar controller operation,  
WC-660 (cont)  
    SLV (slave) (dual installations  
    only), 3-13  
    STAB (stabilization), 3-11  
    target alert characteristics, 3-12  
    TGT (target), 3-12  
    TILT, 3-13

Weather radar indicator operation,  
WI-650/660, 3-1  
    AZ (azimuth), 3-9  
    BRT (brightness) or BRT/LSS  
    (lightning sensor system), 3-9  
        CLR/TST (clear/test), 3-9  
        LX (lightning sensor system),  
        3-9  
    OFF, 3-9  
    SBY (standby), 3-9

display area, 3-5  
    display screen features, 3-5

function switch, 3-5  
    FP (flight plan), 3-6  
    FSBY (forced standby), 3-7  
    OFF, 3-5  
    ON, 3-6  
    SBY (standby), 3-5  
    TST (test), 3-7

GAIN, 3-8

GMP (ground mapping) button or  
MAP, 3-2

rainfall rate color coding, 3-6

RANGE, 3-9

RCT (rain echo attenuation  
compensation technique  
(REACT)), 3-3

SCT (scan sector), 3-9

TGT (target), 3-4  
    target alert characteristics,  
    3-4

TILT, 3-8

WX (weather) button, 3-2