

BLU-RAY DISC PLAYER

# **DBS-30.2**

Instruction Manual

**Integra**

**WARNING:**

TO REDUCE THE RISK OF FIRE OR ELECTRIC SHOCK, DO NOT EXPOSE THIS APPARATUS TO RAIN OR MOISTURE.

**CAUTION:**

TO REDUCE THE RISK OF ELECTRIC SHOCK, DO NOT REMOVE COVER (OR BACK). NO USER-SERVICEABLE PARTS INSIDE. REFER SERVICING TO QUALIFIED SERVICE PERSONNEL.



**WARNING**  
RISK OF ELECTRIC SHOCK  
DO NOT OPEN

**AVIS**  
RISQUE DE CHOC ELECTRIQUE  
NE PAS OUVRIR



The lightning flash with arrowhead symbol, within an equilateral triangle, is intended to alert the user to the presence of uninsulated "dangerous voltage" within the product's enclosure that may be of sufficient magnitude to constitute a risk of electric shock to persons.



The exclamation point within an equilateral triangle is intended to alert the user to the presence of important operating and maintenance (servicing) instructions in the literature accompanying the appliance.



The caution marking is located on the rear or bottom of the cabinet.



The symbol for CLASS II (Double Insulation)

## Important Safety Instructions

1. Read these instructions.
2. Keep these instructions.
3. Heed all warnings.
4. Follow all instructions.
5. Do not use this apparatus near water.
6. Clean only with dry cloth.
7. Do not block any ventilation openings. Install in accordance with the manufacturer's instructions.
8. Do not install near any heat sources such as radiators, heat registers, stoves, or other apparatus (including amplifiers) that produce heat.
9. Do not defeat the safety purpose of the polarized or grounding-type plug. A polarized plug has two blades with one wider than the other. A grounding type plug has two blades and a third grounding prong. The wide blade or the third prong are provided for your safety. If the provided plug does not fit into your outlet, consult an electrician for replacement of the obsolete outlet.
10. Protect the power cord from being walked on or pinched particularly at plugs, convenience receptacles, and the point where they exit from the apparatus.
11. Only use attachments / accessories specified by the manufacturer.
12. Use only with the cart, stand, tripod, bracket, or table specified by the manufacturer, or sold with the apparatus. When a cart is used, use caution when moving the cart / apparatus combination to avoid injury from tip-over.
 
13. Unplug this apparatus during lightning storms or when unused for long periods of time.
14. Refer all servicing to qualified service personnel. Servicing is required when the apparatus has been damaged in any way, such as power-supply cord or plug is damaged, liquid has been spilled or objects have fallen into the apparatus, the apparatus has been exposed to rain or moisture, does not operate normally, or has been dropped.
15. Damage Requiring Service
 

Unplug the apparatus from the wall outlet and refer servicing to qualified service personnel under the following conditions:

  - A. When the power-supply cord or plug is damaged,
  - B. If liquid has been spilled, or objects have fallen into the apparatus,
  - C. If the apparatus has been exposed to rain or water,
  - D. If the apparatus does not operate normally by following the operating instructions. Adjust only those controls that are covered by the operating instructions as an improper adjustment of other controls may result in damage and will often require extensive work by a qualified technician to restore the apparatus to its normal operation,
  - E. If the apparatus has been dropped or damaged in any way, and
  - F. When the apparatus exhibits a distinct change in performance this indicates a need for service.
16. Object and Liquid Entry
 

Never push objects of any kind into the apparatus through openings as they may touch dangerous voltage points or short-out parts that could result in a fire or electric shock.

The apparatus shall not be exposed to dripping or splashing and no objects filled with liquids, such as vases shall be placed on the apparatus.

Don't put candles or other burning objects on top of this unit.
17. Batteries
 

Always consider the environmental issues and follow local regulations when disposing of batteries.
18. If you install the apparatus in a built-in installation, such as a bookcase or rack, ensure that there is adequate ventilation.
 

Leave 20 cm (8") of free space at the top and sides and 10 cm (4") at the rear. The rear edge of the shelf or board above the apparatus shall be set 10 cm (4") away from the rear panel or wall, creating a flue-like gap for warm air to escape.

# PRECAUTIONS

Do not place the unit on the furniture that is capable of being tilted by a child and an adult leaning, pulling, standing or climbing on it. A falling unit can cause serious injury or even death.

- 1. Recording Copyright**—Unless it's for personal use only, recording copyrighted material is illegal without the permission of the copyright holder.
- 2. AC Fuse**—The AC fuse inside the unit is not user-serviceable. If you cannot turn on the unit, contact the dealer from whom you purchased this unit.
- 3. Care**—Occasionally you should dust the unit all over with a soft cloth. For stubborn stains, use a soft cloth dampened with a weak solution of mild detergent and water. Dry the unit immediately afterwards with a clean cloth. Don't use abrasive cloths, thinners, alcohol, or other chemical solvents, because they may damage the finish or remove the panel lettering.

#### 4. Power

##### **WARNING**

BEFORE PLUGGING IN THE UNIT FOR THE FIRST TIME, READ THE FOLLOWING SECTION CAREFULLY.

AC outlet voltages vary from country to country. Make sure that the voltage in your area meets the voltage requirements printed on the unit's rear panel (AC 120 V, 60 Hz).

The power cord plug is used to disconnect this unit from the AC power source. Make sure that the plug is readily operable (easily accessible) at all times.

Pressing [I/  On / Standby] to select Standby mode does not fully shutdown the unit. If you do not intend to use the unit for an extended period, remove the power cord from the AC outlet.

#### 5. Preventing Hearing Loss

##### **Caution**

Excessive sound pressure from earphones and headphones can cause hearing loss.

#### 6. Batteries and Heat Exposure

##### **Warning**

Batteries (battery pack or batteries installed) shall not be exposed to excessive heat as sunshine, fire or the like.

#### 7. Never Touch this Unit with Wet Hands—

Never handle this unit or its power cord while your hands are wet or damp. If water or any other liquid gets inside this unit, have it checked by the dealer from whom you purchased this unit.

#### 8. Handling Notes

- If you need to transport this unit, use the original packaging to pack it how it was when you originally bought it.
- Do not leave rubber or plastic items on this unit for a long time, because they may leave marks on the case.

- This unit's top and rear panels may get warm after prolonged use. This is normal.
- If you do not use this unit for a long time, it may not work properly the next time you turn it on, so be sure to use it occasionally.
- When you've finished using this unit, remove all discs and turn off the power.

#### 9. Installing this Unit

- Install this unit in a well-ventilated location.
- Ensure that there's adequate ventilation all around this unit, especially if it's installed in an audio rack. If the ventilation is inadequate, the unit may overheat, leading to malfunction.
- Do not expose this unit to direct sunlight or heat sources, because its internal temperature may rise, shortening the life of the optical pickup.
- Avoid damp and dusty places, and places subject to vibrations from loudspeakers.
- Never put the unit on top of, or directly above a loud-speaker.
- Install this unit horizontally. Never use it on its side or on a sloping surface, because it may cause a malfunction.
- If you install this unit near a TV, radio, or VCR, the picture and sound quality may be affected. If this occurs, move this unit away from the TV, radio, or VCR.

**10. To Obtain a Clear Picture**—This unit is a high-tech, precision device. If the lens on the optical pickup, or the disc drive mechanism becomes dirty or worn, the picture quality may be affected. To maintain the best picture quality, we recommend regular inspection and maintenance (cleaning or worn part replacement). Contact the dealer from whom you purchased this unit.

#### 11. Moisture Condensation

##### **Moisture condensation may damage this unit.**

Read the following carefully:

Moisture may condense on the lens of the optical pickup, one of the most important parts inside this unit.

- Moisture condensation can occur in the following situations:
  - The unit is moved from a cold place to a warm place.
  - A heater is turned on, or cold air from an air conditioner is hitting the unit.
  - In the summer, when this unit is moved from an air conditioned room to a hot and humid place.
  - The unit is used in a humid place.

# PRECAUTIONS

- Do not use this unit when there's the possibility of moisture condensation occurring. Doing so may damage your discs and certain parts inside this unit. If condensation does occur, remove all discs and leave this unit turned on for two to three hours. By this time, the unit will have warmed up and any condensation will have evaporated.

**12. Region Codes**—The BD/DVD standard uses region codes to control how discs can be played around the world, the world being divided into three regions (BD) or six regions (DVD). This unit will only play BD/DVD discs that match its region code, which can be found on its rear panel (  ).

**13. About this Manual**—This manual explains how to use all of this unit's functions. Although the BD/DVD standard offers many special features, not all discs use them all, so depending on the disc being played, this unit may not respond to certain functions. See the disc's sleeve notes for supported features.

This unit contains a semiconductor laser system and is classified as a "CLASS 1 LASER PRODUCT". So, to use this model properly, read this Instruction Manual carefully. In case of any trouble, please contact the store where you purchased the unit.

To prevent being exposed to the laser beam, do not try to open the enclosure.

## CAUTION:

VISIBLE AND INVISIBLE LASER RADIATION WHEN OPEN AND INTERLOCK FAILED OR DEFEATED. DO NOT STARE INTO BEAM.

THIS PRODUCT UTILIZES A LASER. USE OF CONTROLS OR ADJUSTMENTS OR PERFORMANCE OF PROCEDURES OTHER THAN THOSE SPECIFIED HEREIN MAY RESULT IN HAZARDOUS RADIATION EXPOSURE.

The label on the right is applied on the rear panel.



1. This unit is a CLASS 1 LASER PRODUCT and employs a laser inside the cabinet.
2. To prevent the laser from being exposed, do not remove the cover. Refer servicing to qualified personnel.

## For U.S. Models

### FCC Information for User

#### CAUTION:

The user changes or modifications not expressly approved by the party responsible for compliance could void the user's authority to operate the equipment.

#### NOTE:

This equipment has been tested and found to comply with the limits for a Class B digital device, pursuant to Part 15 of the FCC Rules. These limits are designed to provide reasonable protection against harmful interference in a residential installation.

This equipment generates, uses and can radiate radio frequency energy and, if not installed and used in accordance with the instructions, may cause harmful interference to radio communications. However, there is no guarantee that interference will not occur in a particular installation. If this equipment does cause harmful interference to radio or television reception, which can be determined by turning the equipment off and on, the user is encouraged to try to correct the interference by one or more of the following measures:

- Reorient or relocate the receiving antenna.
- Increase the separation between the equipment and receiver.
- Connect the equipment into an outlet on a circuit different from that to which the receiver is connected.
- Consult the dealer or an experienced radio/TV technician for help.

## For Canadian Models

**NOTE:** THIS CLASS B DIGITAL APPARATUS COMPLIES WITH CANADIAN ICES-003.

## Modèle pour les Canadien

**REMARQUE:** CET APPAREIL NUMÉRIQUE DE LA CLASSE B EST CONFORME À LA NORME NMB-003 DU CANADA.

# PRECAUTIONS

## Supplied Accessories

Remote Control with  
AA (1.5V) battery x 2

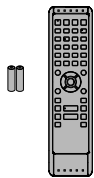

RCA audio / video cables

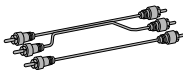

AC cord

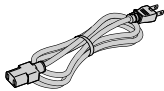

Instruction Manual



Netflix Box-insert



## Note about Recycling

- This unit's packaging materials are recyclable and can be reused. Please dispose of any materials in accordance with your local recycling regulations.
- Batteries should never be thrown away or incinerated but disposed of in accordance with your local regulations concerning chemical wastes.



## Maintenance

### Servicing

- Please refer to relevant topics on "TROUBLESHOOTING" on page 57 before returning the product.
- If this unit becomes inoperative, do not try to correct the problem by yourself. There are no user-serviceable parts inside. Turn the unit to the standby mode, unplug the power plug, and please contact the dealer from whom you purchased this unit.

### Disc handling

- For best results, keep your discs clean. Fingerprints and dust can affect the sound and picture quality and should be removed as follows. Using a clean, soft cloth, wipe from the center outwards, as shown. Never wipe in a circular direction.



- To remove stubborn dust or dirt, wipe the disc with a damp, soft cloth, and then dry it with a dry cloth.
- Never use solvent-based cleaning fluids, such as thinner or benzene, commercially available cleaners, or antistatic sprays intended for vinyl records, because they may damage the disc.

## IR signal check

- If the remote control is not working properly, you can use a digital camera (including a cellular phone with built-in camera) to see if it is sending out an infrared signal.

### With a digital camera (including built-in cell phone cameras):

Point a digital camera towards the remote control. Push any button on the remote control and look through the digital camera. If the infrared light appears through the camera, the remote control is working.



## Copyright

- It is forbidden by law to copy, broadcast, show, broadcast on cable, play in public, or rent copyrighted material without permission. Commercial BD-video/DVD-video discs are copy-protected, and any recordings made from these discs will be distorted. This item incorporates copy protection technology that is protected by U.S. patents and other intellectual property rights of Rovi Corporation. Reverse engineering and disassembly are prohibited.

## Note about AC Cord

- Use only the supplied AC cord.
- Do not use the supplied AC cord to other units.

# PRECAUTIONS

## Trademark Information



HDMI, the HDMI Logo, and High-Definition Multimedia Interface are trademarks or registered trademarks of HDMI Licensing LLC in the United States and other countries.



Manufactured under license from Dolby Laboratories. Dolby and the double-D symbol are trademarks of Dolby Laboratories.



Manufactured under license under U.S. Patent #'s: 5,451,942; 5,956,674; 5,974,380; 5,978,762; 6,226,616; 6,487,535; 7,392,195; 7,272,567; 7,333,929; 7,212,872 & other U.S. and worldwide patents issued & pending. DTS and the Symbol are registered trademarks, & DTS-HD, DTS-HD Master Audio | Essential and the DTS logos are trademarks of DTS, Inc. Product includes software. © DTS, Inc. All Rights Reserved.

### x.v.Color

"x.v.Color" and "x.v.Color" logo are trademarks of Sony Corporation.



Java and all other Java trademarks and logos are trademarks or registered trademarks of Sun Microsystems, Inc. in the United States and/or other countries.



Windows Media and the Windows logo are trademarks or registered trademarks of Microsoft Corporation in the United States and/or other countries.



"AVCHD" and the "AVCHD" logo are trademarks of Panasonic Corporation and Sony Corporation.



"BONUSVIEW" is trademark of Blu-ray Disc Association.



"BD-Live" and "BD-Live" logo are trademarks of Blu-ray Disc Association.



DLNA®, the DLNA Logo and DLNA CERTIFIED® are trademarks, service marks, or certification marks of the Digital Living Network Alliance.





Netflix and the Netflix logo are trademarks or registered trademarks of Netflix, Inc.



© 2010 Sonic Solutions. Roxio, CinemaNow, Roxio CinemaNow and the Roxio CinemaNow logos are trademarks or registered trademarks owned by Sonic Solutions in the United States and other jurisdictions.



BLOCKBUSTER name, design and related marks are trademarks of Blockbuster Inc.

"Blu-ray Disc" and  are trademarks.  is a trademark of DVD Format/Logo Licensing Corporation.

# CONTENTS

## Introduction

<b>PRECAUTIONS</b> .....	<b>3</b>
<b>FEATURES</b> .....	<b>8</b>
Features .....	8
Symbols Used in this Manual .....	9
<b>FUNCTIONAL OVERVIEW</b> .....	<b>10</b>
Front Panel .....	10
Rear Panel .....	10
Remote Control .....	11
Opening Screen .....	12
Front Panel Display .....	13

## Connections

<b>CONNECTIONS</b> .....	<b>14</b>
Connection to the TV .....	14
Connection to an Audio System .....	17
Connecting the AC Cord .....	19
Network Connection with LAN .....	19
Controlling AV Components that are Out of Range .....	20

## Playback

<b>INFORMATION ON PLAYBACK</b> .....	<b>21</b>
<b>BASIC PLAYBACK</b> .....	<b>24</b>
Playing Back a BD, DVD or a Disc with AVCHD Files .....	24
Operations Using Title Menu, Disc Menu, and Pop-up Menu .....	25
Playing Back an Audio CD or a Disc with MP3/WMA/JPEG Files .....	25
Reading the SD Memory Card .....	26
Playing Video/Music/Photo Files from DLNA Certified Home Media Servers .....	28
<b>SPECIAL PLAYBACK</b> .....	<b>30</b>
Fast Forward/Fast Reverse .....	30
Slow Forward Playback .....	30
Step by Step Playback .....	30
Repeat Playback .....	30
A-B Repeat .....	31
PIP (Picture in Picture) (BONUSVIEW) Setting .....	31
Program Playback .....	31
Random Playback .....	32
Rapid Playback .....	33
Camera Angle .....	33
Enjoying BD-Live Discs with Internet .....	33
<b>SEARCH</b> .....	<b>34</b>
<b>SPECIAL SETTINGS</b> .....	<b>35</b>
Switching Subtitles .....	35
Switching Audio Soundtrack .....	35
Setting the BD Audio Mode .....	36
Adjusting the Picture .....	36

<b>NETFLIX OPERATIONS</b> .....	<b>37</b>
Before Activating the Connection to Netflix .....	37
Activating the Connection to Netflix .....	37
Watching Streaming Movies .....	37
<b>CINEMANOW / BLOCKBUSTER OPERATIONS</b> .....	<b>38</b>
Before Activating the Connection to CinemaNow/Blockbuster .....	38
Activating the Connection to CinemaNow/Blockbuster .....	38
Guide to CinemaNow/Blockbuster Menu Screen .....	38
Renting or Purchasing Movies/TV Episodes .....	39
Searching Movies/TV Episodes .....	39
Watching Rented or Purchased Movies/TV Episodes .....	39

## Function Setup

<b>FUNCTION SETUP</b> .....	<b>40</b>
Using the Setup Menu .....	40
Network Connection .....	52
Software Update .....	55

## Others

<b>TROUBLESHOOTING</b> .....	<b>57</b>
<b>GLOSSARY</b> .....	<b>59</b>
<b>LANGUAGE CODE</b> .....	<b>61</b>
<b>SPECIFICATIONS</b> .....	<b>62</b>
<b>NETWORK SERVICE DISCLAIMER</b> .....	<b>63</b>

## Features

### Full high-definition video playback

Watch movies in the highest picture quality available for your HDTV. This unit offers full high-definition video playback up to 1080p resolution for an amazing viewing experience. A highly detailed picture and increased sharpness delivers a more true-to-life picture.

### DVD upscaling for enhanced picture quality

Your current DVD will look even better than before thanks to video upconversion. Upconversion will increase the resolution of standard definition DVD to high definition up to 1080p over an HDMI connection. The picture will be less jagged and more realistic for a near high-definition experience.

### Enjoy your content on different kinds of media

Full backwards compatibility with DVD, CD and SD card ensures that you can continue to enjoy your current audio-video collection. Additionally, you can view JPEG digital pictures or listen to MP3 or Windows Media™ Audio music files.

### Listen to the rich multi-channel surround sound

Multi-channel surround sound, which recognizes real-to-life sound and makes you feel like you are really there.

### Easy and simple connection to your HDTV via HDMI

Connect this unit to your HDTV with one single HDMI (High-Definition Multimedia Interface) cable. It is recommended to use a High Speed HDMI cable for better compatibility. The high definition video output signal will be transferred to your HDTV without conversion to analog signals, so you will get excellent picture and sound quality, completely free from noise.

Thanks to other multiple outputs, you can also easily connect to your home theater system or amplifier.

### HDMI CEC (Consumer Electronics Control)

This unit supports HDMI CEC, which allows integrated system control over HDMI and is part of the HDMI standard. The company does not guarantee 100% interoperability with other brands of HDMI CEC compliant devices.

### PIP (BONUSVIEW)

Some BD-videos have the PIP function which enables you to display the secondary video in the primary video. You can call up the secondary video by pressing [PIP] whenever the scene contains the secondary video.

### BD-Live

BD-Live (BD-ROM version 2 Profile 2.0) that allows interactive functions to be used when this unit is connected to the Internet in addition to the BONUSVIEW function. The various functions differ depending on the disc.

### Pop-up menu

Some BD-videos have a pop-up menu which is a navigation menu that can be called up and be operated on the TV screen without interrupting playback. You can call up the pop-up menu by pressing [Pop Up Menu / Menu]. Contents in the pop-up menu vary depending on the disc.

### Rapid playback

Playback in slightly faster speed while keeping the sound output.

Rapid playback is available only on discs recorded in the Dolby Digital format.

### HDMI Deep Color

Deep Color reduces posterization effect of the playback image. Refer to "HDMI Deep Color" in "FUNCTION SETUP" on page 43.

### HDMI 1080p24 output (BD only)

This unit is equipped with the feature which can provide smooth movement during playback of film originated material with the frame rate of 24 frames per second with progressive. (Available only when the display device is connected by an HDMI cable.)

Refer to "HDMI Video Resolution" in "FUNCTION SETUP" on page 43.

### Playing back the contents from an SD Memory Card

You can play back AVCHD/MP3/WMA/JPEG stored in an SD Memory Card. BD-ROM Profile 2.0 (BD-Live) and Profile 1.1 discs sometimes store picture-in-picture commentary, subtitles or other extras in the SD Memory Card for use during playback with the BD-video.

### Playing back AVCHD files

This unit supports playback of AVCHD format files (new format for high definition video camcorders) recorded on disc / SD card. Your high definition personal archive is playable in HD quality.

### x.v.Color

This unit supports playback of video contents on discs recorded with "x.v.Color" technology. To watch this video content with the "x.v.Color" space, a TV or other display device supporting both video image reproduction using "x.v.Color" standard and capability of manual switching of its color space setting is required. Please refer to the owner's manual of your display device for further information.

### Enjoy contents stored on DLNA certified home media servers

This unit is a DLNA certified media player that can play video, music and photo files stored on DLNA certified home media servers connected to your home network.

### Netflix

With this unit, you can enjoy movies and TV episodes streamed instantly from Netflix via the Internet. In order to use this feature, you must visit [netflix.com/Integra](http://netflix.com/Integra) on your PC and become a Netflix member.

(This feature is available only in the United States.)

### CinemaNow / Blockbuster

With this unit, you can enjoy movies and TV episodes streamed instantly from CinemaNow / Blockbuster via the Internet. In order to use this feature, you must visit following website on your PC and become a CinemaNow / Blockbuster member.











- CinemaNow : [www.cinemanow.com/Login](http://www.cinemanow.com/Login)

- Blockbuster : [www.blockbuster.com/auth/login](http://www.blockbuster.com/auth/login)



## Symbols Used in this Manual

To specify for which media type each function is, we put the following symbols at the beginning of each item to operate.

Symbol	Description
	Description refers to BD-video and BD-RE (ver. 2.1) / BD-R (ver. 1.1 / 1.2 / 1.3) recorded in BDMV format
	Description refers to DVD-video
	Description refers to audio CD / DTS-CD
	Description refers to DVD-RW/-R and SD card with AVCHD files
	Description refers to BD-RE/-R, DVD-RW/-R, CD-RW/-R and SD card with MP3 files
	Description refers to BD-RE/-R, DVD-RW/-R, CD-RW/-R and SD card with Windows Media™ Audio files
	Description refers to BD-RE/-R, DVD-RW/-R, CD-RW/-R and SD card with JPEG files
	Description refers to video files in the DLNA home server
	Description refers to music files in the DLNA home server
	Description refers to photo files in the DLNA home server

If you do not find any of the symbols listed above under the function heading, the operation is applicable to all media.

# FUNCTIONAL OVERVIEW

## Front Panel

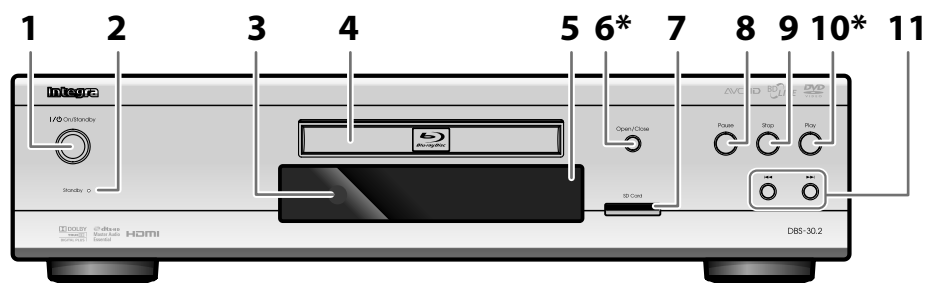

\* The unit can also be turned on by pressing these buttons.

### 1. I / On/Standby button

- Press to turn on the unit, or to turn the unit into the standby mode. (To completely shut down the unit, you must unplug the AC power cord)

### 2. Standby indicator

- This indicator lights up in red when the unit is in standby mode and turns off when the unit is active.

### 3. Infrared sensor window

- Receive signals from your remote control so that you can control the unit from a distance.

### 4. Disc tray

- Place a disc when opening the disc tray.

### 5. Display

- Refer to "Front Panel Display" on page 13.

### 6. Open/Close button\*

- Press to open or close the disc tray.

### 7. SD Card slot

- Insert an SD Memory Card, and play back the contents in it.

### 8. Pause button

- Press to pause playback.

### 9. Stop button

- Press to stop playback.

### 10. Play button\*

- Press to start or resume playback.

### 11. Skip down/up buttons

- Press to skip to the previous or next title / chapter / track / file.

## Rear Panel

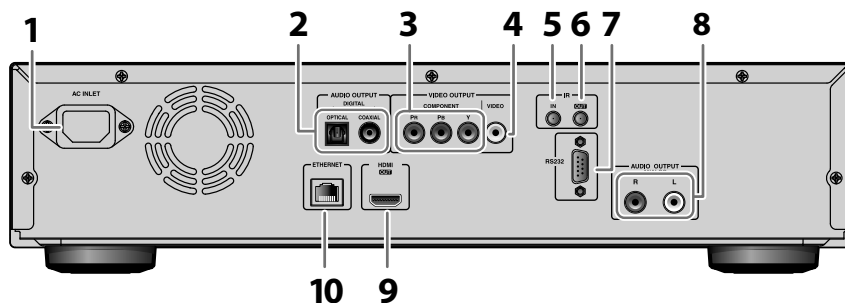

### 1. AC INLET terminal

- Use to connect the AC outlet with the AC cord.

### 2. AUDIO OUTPUT (DIGITAL OPTICAL / COAXIAL) jacks

- Use to connect an AV receiver / amplifier, Dolby Digital / DTS decoder or other device with a digital audio optical / coaxial input jack with a digital audio optical / coaxial cable.

### 3. VIDEO OUTPUT (COMPONENT) jacks

- Use to connect a TV with component video inputs with an RCA component video cable.

### 4. VIDEO OUTPUT (VIDEO) jack

- Use to connect a TV, an AV receiver or other device with an RCA video cable.

### 5. IR IN jack

- A commercially available IR receiver can be connected to the IR IN jack, allowing you to control the BD player when it's out of sight, for example, installed in a cabinet.

### 6. IR OUT jack

- A commercially available IR emitter can be connected to the IR OUT jack to pass IR (infrared) remote control signals along to other components.

### 7. CONTROL CONNECTOR (RS-232)

- This bidirectional RS-232 port can be connected to an external controller.

### 8. AUDIO OUTPUT (ANALOG L / R) jacks

- Use to connect a TV, an AV receiver / amplifier or other device with an RCA audio cable.

### 9. HDMI OUT jack

- Use to connect a TV, an AV receiver / amplifier or other device with an HDMI compatible port with an HDMI cable.

### 10. ETHERNET terminal

- Use to connect a network equipment with LAN cable.

### Note

- Do not touch the inner pins of the jacks on the rear panel. Electrostatic discharge may cause permanent damage to the unit.
- This unit does not have the RF modulator.

## Remote Control

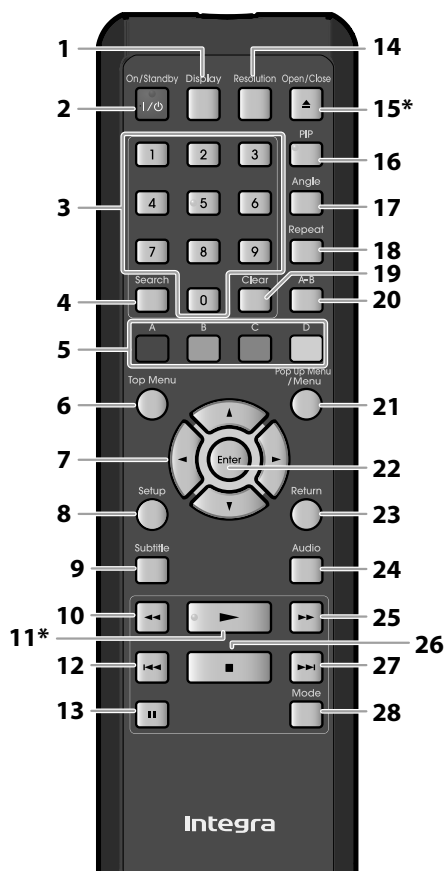

\* The unit can also be turned on by pressing these buttons.

### 1. Display button

- Press to display the on-screen display menu.

### 2. On / Standby I / O button

- Press to turn on the unit, or to turn the unit into the standby mode. (To completely shut down the unit, you must unplug the AC power cord)

### 3. Number buttons

- Press to enter the title, chapter, track or file number.
- Press to enter values in the input field.

### 4. Search button

- Press to display the search menu.

### 5. A / B / C / D button

- Press to select items on some BD menus.
- When file list / thumbnail list is shown, press to switch between pages.

### 6. Top Menu button

- Press to display the top menu.
- During DLNA home media server, Netflix / CinemaNow / Blockbuster feature screen is displayed (except during playback), press to exit.

### 7. ▲ / ▼ / ◀ / ▶ buttons

- Press to select items or settings.

### 8. Setup button

- Press to display the setup menu.

### 9. Subtitle button

- Press to display the subtitle menu.

### 10. Rev ◀◀ button

- During playback, press to fast reverse the playback.

### 11. Play ▶▶ button\*

- Press to start playback or resume playback.

### 12. Skip ◀◀ button

- During playback, press once to return to the beginning of the current title, chapter, track or file.
- During playback, press twice to return to the previous title, chapter, track or file.
- During the JPEG playback, press to return to the previous file.

### 13. Pause || button

- Press to pause playback.
- When playback is in pause mode, press repeatedly to forward the playback step by step.

### 14. Resolution button

- Press to set the HDMI output mode.

### 15. Open / Close ▲ button\*

- Press to open or close the disc tray.

### 16. PIP button

- During BD playback, Press to display the setting for picture-in-picture (only applicable to BD-video which supports the PIP function).

### 17. Angle button

- Press to access various camera angles on the disc.
- Press to rotate the JPEG files clockwise by 90 degrees.

### 18. Repeat button

- Press to toggle between various repeat modes.

### 19. Clear button

- Press to clear the information once entered or to cancel the programming for audio CD, etc.

### 20. A-B button

- Press to play back a defined section between point A and B repeatedly.

### 21. Pop Up Menu / Menu button

- Press to display the pop-up menu / disc menu.

### 22. Enter button

- Press to confirm or select menu items.

### 23. Return button

- Press to return to the previously displayed menu screen.

### 24. Audio button

- Press to display the audio menu.

### 25. Fwd ▶▶ button

- During playback, press to fast forward the playback.
- In pause mode, press to slow forward the playback.

### 26. Stop ■ button

- Press to stop playback.

### 27. Skip ▶▶| button

- During playback, press to skip to the next title, chapter, track or file.

### 28. Mode button

- During BD, DVD or AVCHD files playback, press to display the setting for the rapid playback and the picture adjustment.
- During BD playback, press to display the setting for the picture-in-picture (only applicable to BD-video which supports the PIP function).
- In stop mode with BD inserted, press to display a menu for setting the BD audio mode.
- In stop mode with audio CD, or a disc with MP3 / WMA / JPEG files inserted, press to display menus for program and random playback.
- During the JPEG playback, press to display menus for changing the visual effect for switching the image or changing the size of the image.

# FUNCTIONAL OVERVIEW

## Installing the Batteries in the Remote Control

Install 2 AA (1.5 V) batteries matching the polarity indicated inside battery compartment of the remote control.

### 1 Open the cover.

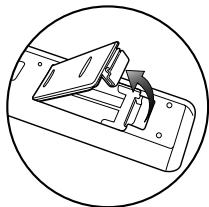

### 2 Insert batteries.

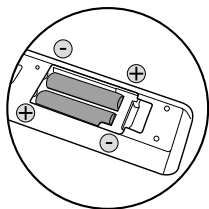

Make sure to match + and - on the batteries to the marks indicated in the battery compartment.

### 3 Close the cover.

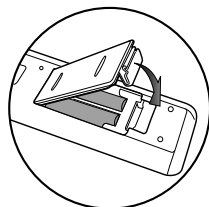

### Note

**Incorrect use of batteries can result in hazards such as leakage and bursting. Please observe the following:**

- Do not mix new and old batteries together.
- Do not use different kinds of batteries together. Although they may look similar, different batteries may have different voltages.
- Make sure that the + and - ends of each battery match the indications in the battery compartment.
- Remove batteries from battery compartment that is not going to be used for a month or more.
- When disposing of used batteries, please comply with governmental regulations or environmental public instruction's rules that apply in your country or area.
- Do not recharge, short-circuit, heat, burn or disassemble batteries.

## Using a Remote Control

Keep in mind the following when using the remote control:

- Make sure that there are no obstacles between the remote control and the infrared sensor window on the unit.
- Remote operation may become unreliable if strong sunlight or fluorescent light is shining on the infrared sensor window of the unit.
- Remote control for different devices can interfere with each other. Avoid using remote control for other device located close to the unit.
- Replace the batteries when you notice a fall off in the operating range of the remote control.
- The maximum operable ranges from the unit are as follows.

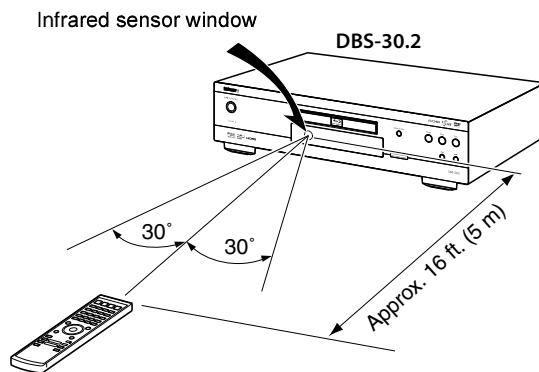

## Opening Screen

In stop mode and "Mode Select" is set to "Network", opening screen is displayed.



- "NETFLIX": To access the Netflix screen
- "CinemaNow": To access the CinemaNow menu screen
- "BLOCKBUSTER": To access the Blockbuster menu screen
- "Home Network": To access the list of DLNA home server

## Front Panel Display

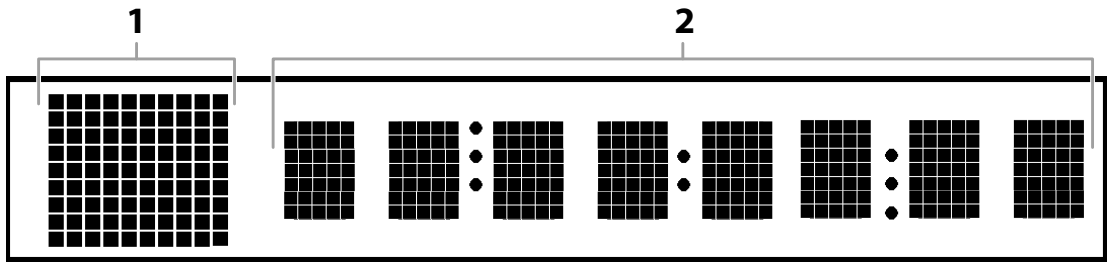

• Brightness of the display can be adjusted. Refer to “Panel Display” in “FUNCTION SETUP” on page 50.

1. Displays playback status icon. Refer to the table below.
2. Displays various kinds of information such as title number, elapsed time, repeat mode, etc.

Playback status icon		Mode
Disc	SD Memory Card	
		Playback is in progress
		Stop mode
		Pause mode
		Fast forward mode
		Fast reverse mode
	 (for AVCHD only)	Slow forward mode
		Appears while repeat function is set
		Appears when DLNA home media server is active

### Example of Display Message

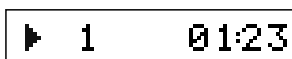

Title is being played back. Indicating the current title number and the elapsed time.



Loading a disc.



Current chapter is in chapter repeat mode.

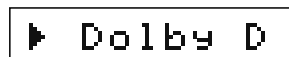

Dolby Digital audio is being played back.



DTS audio is being played back.

# CONNECTIONS

## Connection to the TV

- Make one of the following connections, depending on the capabilities of your existing device.

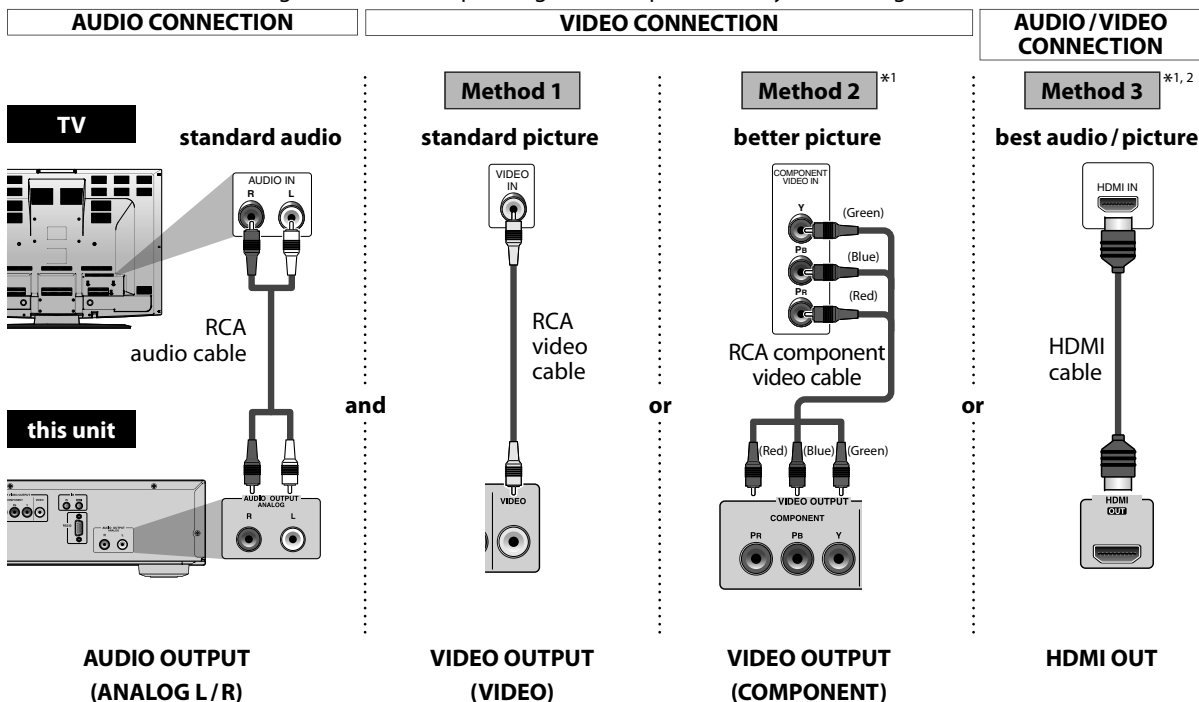

\*1 This unit is compatible with the progressive scan system. The feature provides you with the higher quality pictures than traditional output system does. To utilize this feature, a component or an HDMI connection is required. Refer to "HDMI Video Resolution" or "Component Output" setting on page 43 to set the video resolution.

\*2 - Analog audio connection is not required for this connection.  
 - High Speed HDMI cable (also known as HDMI category 2 cable) is recommended for better compatibility.  
 - Use an HDMI cable with the HDMI logo (a certified HDMI cable) for this connection.

**Supplied cables used in this connection are as follows:**

- RCA audio cable (L/R) x 1
- RCA video cable x 1

Please purchase the rest of the necessary cables at your local store.

**Note**

- Connect this unit directly to the TV. If the RCA audio/video cables are connected to a VCR, pictures may be distorted due to the copy-protection system.
- If the picture is not output properly to the TV because of "HDMI Video Resolution" or "Component Output" setting, press and hold **[Play ▶]** on the front panel for more than 5 seconds. "HDMI Video Resolution" and "Component Output" setting will be reset to the default automatically. You cannot change the video resolution during Blu-ray Disc playback. To change the resolution, stop playback.
- A simple 1-cable connection with a device having an HDMI (High-Definition Multimedia Interface) jack allows digital transfer of both digital video signals and multi-channel audio signals.

## HDMI Output Mode and Actual Output Signals

Press **[Resolution]** to change the resolution of the video signal being output from HDMI OUT jack. The video resolution changes as follows every time **[Resolution]** is pressed.

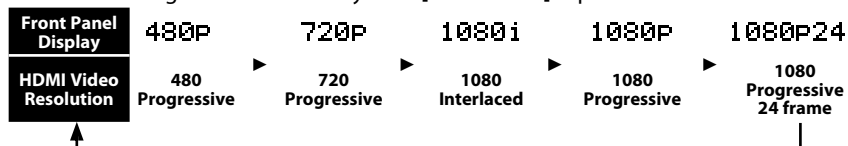

### Copyright protection system

To play back the digital video images of a BD/DVD via an HDMI connection, it is necessary that both the unit and the TV (or an AV receiver) support a copyright protection system called HDCP (high-bandwidth digital content protection system). HDCP is copy protection technology that comprises data encryption and authentication of the connected AV device. This unit supports HDCP. Please read the operating instructions of your TV (or AV receiver) for more information.

### Note

- When using HDCP-incompatible TV, the image will not be viewed properly.
- The audio signals from HDMI OUT jack (including the sampling frequency, the number of channels and bit length) maybe limited by the device that is connected.
- Among the devices that support HDMI, some do not support audio output (e.g. projectors). In connections with device such as this unit, audio signals are not output from HDMI OUT jack.
- Video and audio signals may be distorted temporarily when switching to/from the HDMI output mode.
- You can change the HDMI output mode with **[Resolution]** during playback as well. (This is not available during BD/AVCHD playback.)
- You can also change the HDMI output mode from "HDMI Video Resolution" setting in "Video" menu. In this menu, you can confirm what HDMI video resolutions are supported by connected TV. Refer to page 43.
- In order to get natural and high quality film reproduction of 24-frame film material, use an HDMI cable (High Speed HDMI cable is recommended) and select "1080p24" if the connected TV is compatible with 1080p24 frame input.
- If the disc contains 1080p24 frame material, 60-frame or 50-frame image will be output unless "1080p24" is selected.
- For AVCHD, 24-frame film material will be output as 60 frame, even if the connected device is compatible with 1080p24 frame input and "HDMI Video Resolution" is set to "1080p24" or "Auto".
- If the video is not properly from HDMI OUT jack after you set the "HDMI Video Resolution" setting, change the HDMI video resolution to the compatible resolution by pressing **[Resolution]** or press and hold **[Play ▶]** on the front panel for more than 5 seconds to reset the setting.
- "HDMI Deep Color" is available only when the display device is connected by HDMI cable and supports HDMI Deep Color.
- For "Auto" in "HDMI Deep Color", using the High Speed HDMI cable is recommended.

## HDMI Audio Setting

When using HDMI connections make "HDMI Audio Out" setting in "Audio" menu according to the specifications of the device to be connected. Refer to page 45.

Device to be connected	"HDMI Audio Out" setting	Output HDMI audio signal
Device compatible with Dolby Digital, Dolby Digital Plus, Dolby TrueHD, DTS or DTS-HD decoding	HDMI Multi (Normal)	Dolby Digital, Dolby Digital Plus, Dolby TrueHD, DTS, or DTS-HD bitstream are output from HDMI OUT jack. Make the speaker settings on the connected AV receiver, etc.
Device compatible with 3 or more channels of audio inputs (not Dolby Digital, Dolby Digital Plus, Dolby TrueHD, DTS® or DTS-HD® compatible)	HDMI Multi (LPCM)	Multi-channel audio signals are output from HDMI OUT jack. Make the speaker settings with the speaker setting items appear after you select "HDMI Multi(LPCM)". Refer to page 45.
Device compatible with 2-channel audio input or device not compatible with audio input	HDMI 2ch	Down-mixed 2-channel audio signals are output from HDMI OUT jack.
HDMI connection to a TV and digital audio connection (optical/coaxial) to an AV receiver	Audio Mute	HDMI audio will be mute, and Dolby Digital/DTS bitstream or LPCM will be output from AUDIO OUTPUT (DIGITAL OPTICAL/COAXIAL) jacks depending on "Digital Out" setting. Refer to page 46.

## ■ Audio signals output from HDMI OUT jack

	"HDMI Audio Out" setting →	"HDMI Multi (Normal)"		"HDMI Multi (LPCM)"		"HDMI 2ch"	
	"BD Audio Mode" setting →	"HD Audio Output"	"Mix Audio Output"	"HD Audio Output"	"Mix Audio Output"	"HD Audio Output"	"Mix Audio Output"
Media ↓	Audio Source ↓	Which audio format can be output depends on the compatibility of the connected device.					
BD-video	Dolby Digital	Dolby Digital	Dolby Digital	Multi PCM	Multi PCM	Downmix 2ch PCM	Downmix 2ch PCM
	Dolby Digital Plus	Dolby Digital Plus	Dolby Digital	Multi PCM*1	Multi PCM*2	Downmix 2ch PCM*1	Downmix 2ch PCM*2
	Dolby TrueHD	Dolby TrueHD	Dolby Digital	Multi PCM*3	Multi PCM*4	Downmix 2ch PCM*3	Downmix 2ch PCM*4
	DTS®	DTS®	DTS®	Multi PCM*6	Multi PCM*6	Downmix 2ch PCM	Downmix 2ch PCM
	DTS-HD®	DTS-HD®	DTS®	Multi PCM*1,6	Multi PCM*5,6	Downmix 2ch PCM*1	Downmix 2ch PCM*5
	LPCM	Multi PCM	Multi PCM	Multi PCM	Multi PCM	Downmix 2ch PCM	Downmix 2ch PCM
DVD-video	Dolby Digital	Dolby Digital		Multi PCM		Downmix 2ch PCM	
	DTS®	DTS®		Multi PCM		Downmix 2ch PCM	
	LPCM	2ch PCM		2ch PCM		2ch PCM	
Audio CD	PCM	2ch PCM		2ch PCM		2ch PCM	
DTS-CD	DTS®	DTS®		Multi PCM		Downmix 2ch PCM	
AVCHD	Dolby Digital	Dolby Digital		Multi PCM		Downmix 2ch PCM	
	LPCM	Multi PCM		Multi PCM		Downmix 2ch PCM	
MP3	MP3	2ch PCM		2ch PCM		2ch PCM	
WMA	WMA	2ch PCM		2ch PCM		2ch PCM	
DLNA Video	Dolby Digital	Dolby Digital		Multi PCM		Downmix 2ch PCM	
	MP2	2ch PCM		2ch PCM		2ch PCM	
	LPCM	Multi PCM		Multi PCM		Downmix 2ch PCM	
DLNA Music	MP3 / WMA / LPCM	2ch PCM		2ch PCM		2ch PCM	
Netflix	WMA	2ch PCM		2ch PCM		2ch PCM	
CinemaNow	AAC	AAC		2ch PCM		2ch PCM	
Blockbuster	AAC	AAC		2ch PCM		2ch PCM	

\*1 Full decoded.

\*2 Only the independent substream is decoded.

\*3 Dolby TrueHD stream is decoded.

\*4 Only the Dolby Digital substream is decoded.

\*5 Only the core substream is decoded.

\*6 When audio source is multi-channel, decoded as 7.1ch. However, number of the output audio channel will depend on the number of the connected speakers.

- If the connected device is not compatible with the HDMI BITSTREAM, audio will be output as multi LPCM or 2-channel down-mixed LPCM depending on the capability of the connected device even if you select "HDMI Multi(Normal)" in "HDMI Audio Out" setting. Refer to page 45.
- If the connected device is not compatible with AAC, audio will be output as PCM depending on the capability of the connected device.
- When playing back a BD-video which only contains the primary audio, the audio output will be the same case as the "HD Audio Output" even if the "BD Audio Mode" is set to "Mix Audio Output".

### Note

- The audio signals from HDMI OUT jack (including the sampling frequency, the number of channels and bit length) maybe limited by the device that is connected.
- Among the devices that support HDMI, some do not support audio output (e.g. projectors). In connections with device such as this unit, audio signals are not output from HDMI OUT jack.
- Video and audio signals may be distorted temporarily when switching to/from the HDMI output mode.



# CONNECTIONS

## Connection to an Audio System

- When you change the connections, all devices should be turned off.
- Refer to the manual accompanying external devices for more information.

### 2-Channel Analog Audio Connection

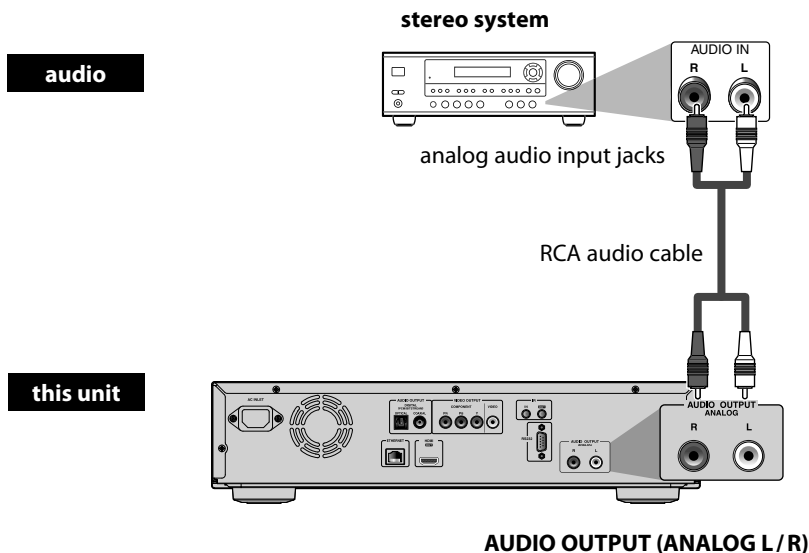

### Digital Audio Connection

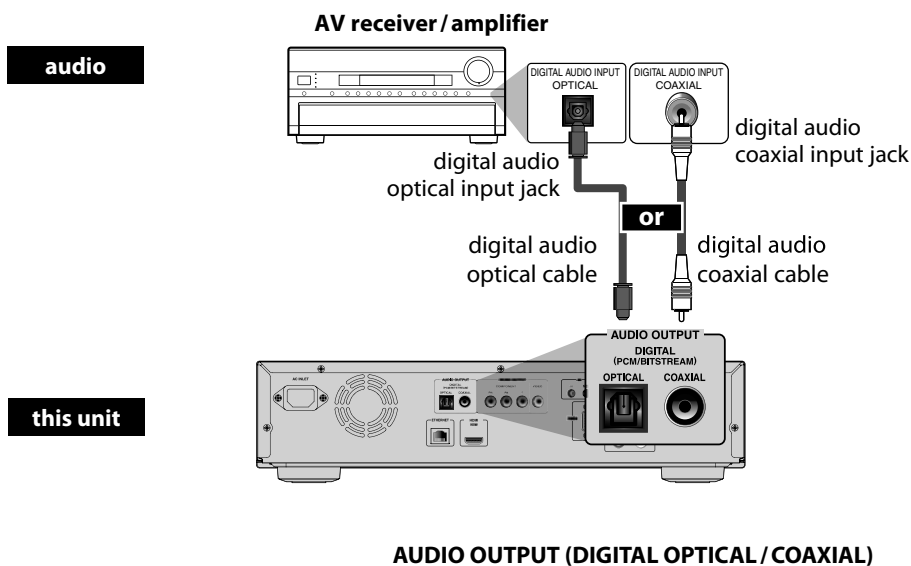

#### Supplied cables used in this connection are as follows:

- RCA audio cable (L/R) x 1

Please purchase the rest of the necessary cables at your local store.

#### Note for Digital Audio Optical Cable

- Digital audio optical cable may be damaged when bent at sharp angles. Endure cables are coiled in loops with a diameter of 6 inches (15cm) or more when storing them.
- Use a cable which is 9.8 feet (3m) or shorter.
- Insert cable plugs firmly into the connectors when making connections.
- If a plug has dust or is dirty, clean it with a soft cloth before inserting it into a connector.

## ■ Audio signals output from AUDIO OUTPUT (DIGITAL OPTICAL / COAXIAL) jacks

For the settings in the “Digital Out” to take effect, “HDMI Audio Out” should be set to “Audio Mute”. Otherwise, the settings made in the “HDMI Audio Out” will have a priority, and the same signal as being output from the HDMI OUT jack will be output from the AUDIO OUTPUT (DIGITAL OPTICAL / COAXIAL) jacks as well. (Except that Dolby Digital will be output instead of Dolby Digital Plus and Dolby TrueHD, and DTS signal will be output instead of DTS-HD.)

	“Digital Out” setting	“Bitstream”		“LPCM”	
	→ “BD Audio Mode” setting →	“HD Audio Output”	“Mix Audio Output”	“HD Audio Output”	“Mix Audio Output”
Media ↓	Audio Source ↓	Which audio format can be output depends on the compatibility of the connected device.			
BD-video	Dolby Digital	Dolby Digital	Dolby Digital	Downmix 2ch PCM	Downmix 2ch PCM
	Dolby Digital Plus	Dolby Digital	Dolby Digital	Downmix 2ch PCM* <sup>1</sup>	Downmix 2ch PCM* <sup>2</sup>
	Dolby TrueHD	Dolby Digital	Dolby Digital	Downmix 2ch PCM* <sup>3</sup>	Downmix 2ch PCM* <sup>4</sup>
	DTS®	DTS®	DTS®	Downmix 2ch PCM	Downmix 2ch PCM
	DTS-HD®	DTS®	DTS®	Downmix 2ch PCM* <sup>1</sup>	Downmix 2ch PCM* <sup>5</sup>
	LPCM	Downmix 2ch PCM	Downmix 2ch PCM	Downmix 2ch PCM	Downmix 2ch PCM
DVD-video	Dolby Digital	Dolby Digital		Downmix 2ch PCM	
	DTS®	DTS®		Downmix 2ch PCM	
	LPCM	2ch PCM		2ch PCM	
Audio CD	PCM	2ch PCM		2ch PCM	
DTS-CD	DTS®	DTS®		Downmix 2ch PCM	
AVCHD	Dolby Digital	Dolby Digital		Downmix 2ch PCM	
	LPCM	Downmix 2ch PCM		Downmix 2ch PCM	
MP3	MP3	2ch PCM		2ch PCM	
WMA	WMA	2ch PCM		2ch PCM	
DLNA Video	Dolby Digital	Dolby Digital		Downmix 2ch PCM	
	MP2	2ch PCM		2ch PCM	
	LPCM	Downmix 2ch PCM		Downmix 2ch PCM	
DLNA Music	MP3 / WMA / LPCM	2ch PCM		2ch PCM	
Netflix	WMA	2ch PCM		2ch PCM	
CinemaNow	AAC	AAC		2ch PCM	
Blockbuster	AAC	AAC		2ch PCM	

\*<sup>1</sup> Full decoded.

\*<sup>2</sup> Only the independent substream is decoded.

\*<sup>3</sup> Dolby TrueHD stream is decoded.

\*<sup>4</sup> Only the Dolby Digital substream is decoded.

\*<sup>5</sup> Only the core substream is decoded.

- When playing back a BD-video which only contains the primary audio, the audio output will be the same case as the “HD Audio Output” even if the “BD Audio Mode” is set to “Mix Audio Output”.
- If the connected device is not compatible with AAC, audio will be output as PCM depending on the capability of the connected device.

### Note

- In order to output LPCM signal from AUDIO OUTPUT (DIGITAL OPTICAL / COAXIAL) jacks while outputting the HDMI audio signal, set “HDMI Audio Out” setting to “HDMI Multi(LPCM)”.

# CONNECTIONS

## Connecting the AC Cord

After you made all necessary connections, connect the AC cord to the AC INLET. Then connect the AC cord to the AC outlet. **Insert the plugs securely. Incomplete connections will result in the generation of noise.**

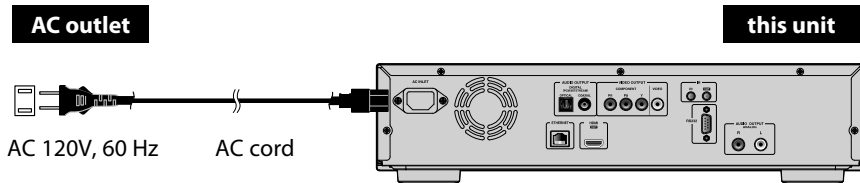

### Supplied cables used in this connection are as follows:

- AC cord x 1

## Network Connection with LAN

- By connecting this unit to the Internet, you can update the software via the Internet, play contents stored on DLNA home media servers or access BD-Live, Netflix, CinemaNow and Blockbuster services.
  - For more information about software update, refer to “Network Update” on page 55.
  - For more information about DLNA, refer to “Playing Video / Music / Photo Files from DLNA Certified Home Media Servers” on page 28.
  - For more information about BD-Live, refer to “Enjoying BD-Live Discs with Internet” on page 33.
  - For more information about Netflix, refer to “NETFLIX OPERATIONS” on page 37.
  - For more information about CinemaNow and Blockbuster, refer to “CINEMANOW / BLOCKBUSTER OPERATIONS” on page 38.

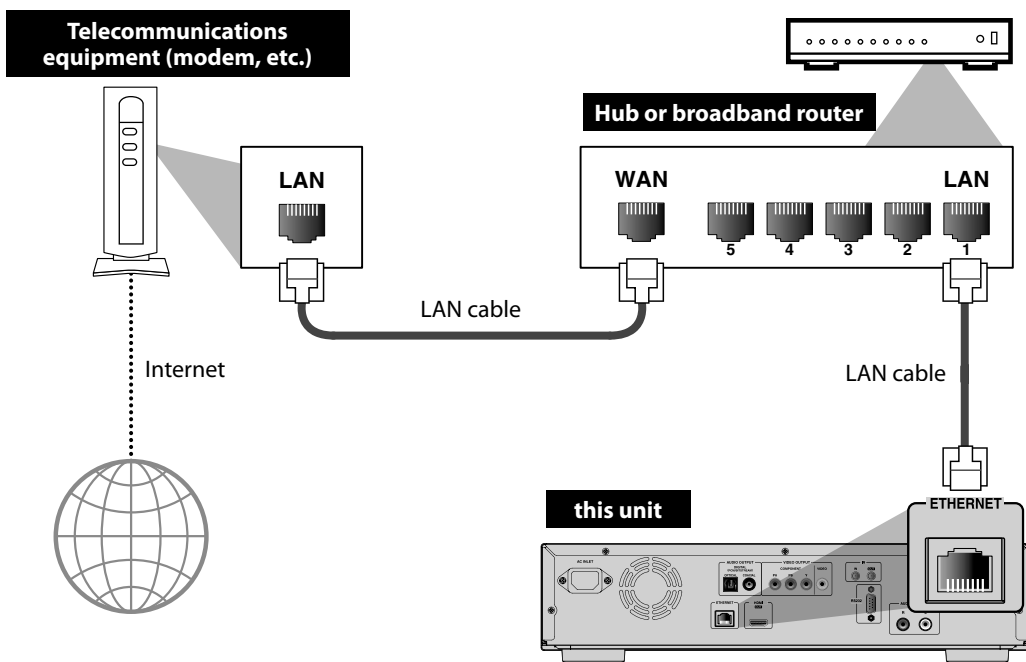

Make sure to connect the telecommunications equipment (modem, etc.) to the ETHERNET terminal via hub or broadband router.

### No supplied cables are used in this connection:

Please purchase the necessary cables at your local store.

## Note

- After connecting to the Internet, set up necessary network settings.
- Do not insert any cable other than a LAN cable to the ETHERNET terminal to avoid damaging the unit.
- If your telecommunications equipment (modem, etc.) does not have broadband router functions, connect a broadband router.
- If your telecommunications equipment (modem, etc.) has broadband router functions but there is no vacant port, use a hub.
- For a broadband router, use a router which supports 10BASE-T / 100BASE-TX.
- Do not connect your PC directly to the ETHERNET terminal of this unit.
- For the network setup, refer to "Network Connection" on pages 52-55.
- For more information about cables or connections, see the manual accompanying modem, broadband router and hub you use.
- Please purchase shielded LAN cables at your local store and use them when you connect to network equipment.

## Controlling AV Components that are Out of Range

You can use the following multi-room kits to control this unit when it's out of range of the remote controller:

- Multiroom kits such as those made by Niles and Xantech.

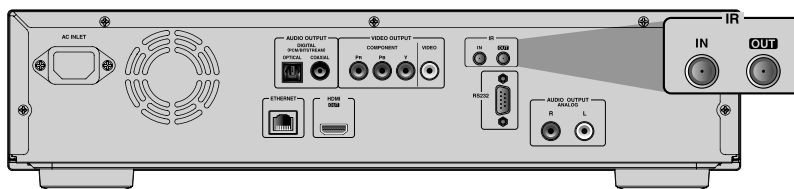

## Controlling Other Out-of-Range AV Components

If another AV component is out of range of its remote controller, you can use a commercially available IR emitter to retransmit the remote controller signals received at this unit's IR IN jack, as shown below.

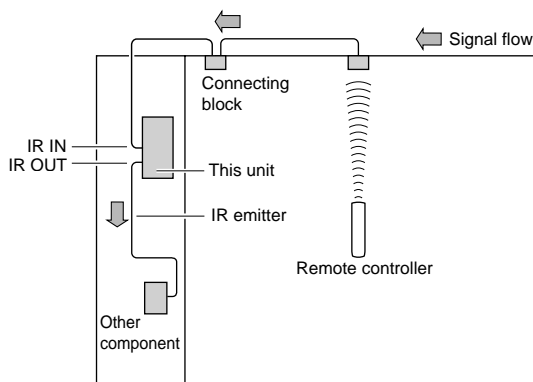

Connect the IR emitter to this unit's IR OUT jack, and place the IR emitter in front of the other AV component's remote control sensor (usually located on its front panel), as shown below. See the instructions supplied with the IR emitter.

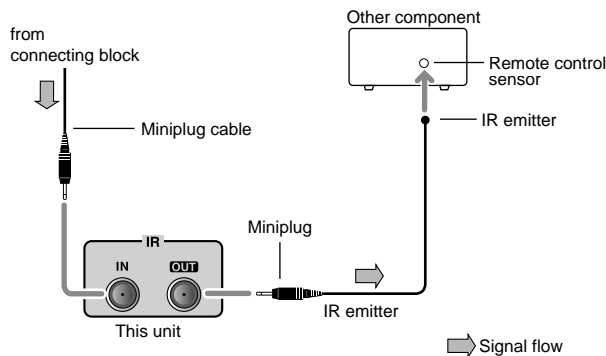

Only remote controller signals received by this unit's IR IN jack are fed through to the IR OUT jack. Signals picked up by this unit's remote control sensor are not output.









# INFORMATION ON PLAYBACK

Before you start playing back a disc, read the following information.

## Playable Discs and Files

This unit is compatible to play back the following discs/files.

To play back a disc/file, make sure that it meets the requirements for region codes and color systems as described below. You can play back discs that have the following logos. Other disc types are not guaranteed to play back.

Playable discs	Logos
Blu-ray Disc - BD-video (single / dual layer) - BD-RE* (ver. 2.1) (single / dual layer) (Recorded in BDMV format) - BD-R (ver. 1.1 / 1.2 / 1.3) (single / dual layer)(Recorded in BDMV format) (Unclosed discs may not be played back.)	
DVD-video	
DVD-RW (single layer) (finalized video mode discs only)	
DVD-R (single / dual layer) (finalized video mode discs only)	
CD-DA (audio CD)	
CD-RW	 
CD-R	 
DTS-CD	—

\* Due to the intentional progression of the Blu-ray Disc format by its standard setting authority, the company cannot guarantee or warrant the playability of future extensions of the Blu-ray Disc format with this product.

File type/ Disc format/ Data	Disc/Card/Media Type					DLNA
	BD-R	BD-RE	DVD-R/-RW	CD-R/-RW	SD Memory Card (8MB - 2GB) SDHC Memory Card (4GB - 8GB) miniSD Card (8MB - 2GB) microSD Card (8MB - 2GB)	
BDMV	○	○	-	-	-	-
video mode	-	-	○	-	-	-
audio CD	-	-	-	○	-	-
MP3, WMA	○	○	○	○	○	○
JPEG	○	○	○	○	○	○
MPEG1, MPEG2	-	-	-	-	-	○
AVCHD	-	-	○	-	○	-
Picture-in-picture commentary, subtitles or other extras for BD-ROM ver. 2 (Profile 2.0 / Profile 1.1)					○	-

○: Supported

### Note for SD Memory Cards

- Do not remove the SD Memory Card or turn the unit to the standby mode while the contents of the card is in playback. It may result in malfunction or loss of the card's data.
- Please keep the SD Memory Cards in their cases when you are not using them.
- Do not try to open or modify the card.
- Do not touch the terminal surface with your fingers or any metals.
- Do not attach additional labels or stickers to cards.
- Do not remove the label of the SD Memory Cards.
- This unit supports SD Memory Card with FAT12 / FAT16 file system, and SDHC Memory Card with FAT32 file system.
- This unit may not read the SD Memory Cards formatted on computer. If that is the case, please reformat the SD Memory Cards in this unit and try again.
- This unit does not support miniSDHC and microSDHC Memory Card.
- For miniSD Card and microSD Card, the adapter is necessary.
- Portions of this product are protected under copyright law and are provided under license by ARIS / SOLANA / 4C.

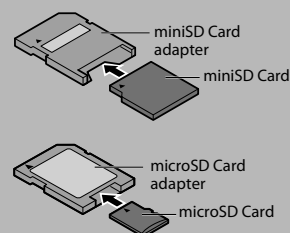

## Unplayable Discs and Files

The following discs will not be played back in this unit.

- CD-ROM
- DVD-RAM
- DVD-audio
- HD DVD
- unfinalized disc
- BD/DVD/CD/SD Memory Card contains DivX® files.
- BD/DVD hybrid disc (played back as a BD-video only)
- BD that contains AVCHD files
- DVD-RW/-R recorded in VR mode or non compatible recording format.
- super audio CD - Only the sound on the CD layer can be heard. The sound on the high-density super audio CD layer cannot be heard.
- Playability of dual discs are not guaranteed.
- BD-RE/-R recorded in BDAV format or non compatible recording format.
- This unit cannot play back the disc contents protected by Windows Media™ Digital Rights Management (DRM).
- CD-I (compact disc-interactive)
- VSD (video single disc)
- video CD
- SVCD

## Color Systems

BD-video and DVD-video are recorded in different color systems throughout the world. The most common color system is NTSC (which is used primarily in the United States and Canada).

This unit employs NTSC color system, so the disc you play back must be recorded in the NTSC system. You cannot play back the disc recorded in other color systems.

## Region Codes

This unit has been designed to play back BD-video with region "A" and DVD-video with region "1" or "ALL". You cannot play back BD-video or DVD-video that are labeled for other regions. Look for the symbols on the right on your BD-video or DVD-video.

If these region symbols do not appear on your BD-video or DVD-video, you cannot play back the disc in this unit. The letter or number inside the globe refers to region of the world. A BD-video or DVD-video labeled for a specific region can only be played back in the unit with the same region code.

BD-video



DVD-video



## Structure of Disc / SD Memory Card Contents

The contents of BD / DVD are generally divided into titles. Titles may be further subdivided into chapters.

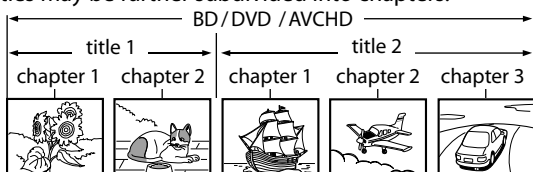

Audio CDs are divided into tracks.

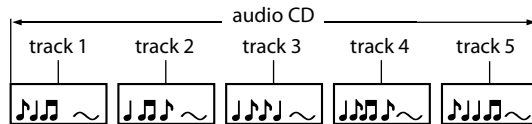

Data discs or SD Memory Cards containing MP3 / WMA / JPEG are divided into folders, and the folders are subdivided into files.

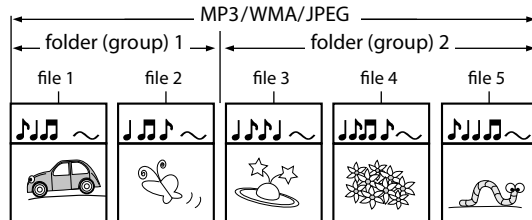

## On-Screen Display

You can check information about the current disc by pressing **[Display]**.

To call the on-screen display menu, press **[Display]** during playback. Every time you press **[Display]**, the information changes. Depending on the media, available information varies.



- off → Title / Chapter information
- Title information (elapsed time)
- Title information (remaining time)
- Decoding format information → off



- off → Chapter information (elapsed time)
- Chapter information (remaining time)
- Title information (elapsed time)
- Title information (remaining time)
- Decoding format information → off



- off (Track information (elapsed time))
  - Track information (remaining time)
  - Disc information\* (elapsed time)
  - Disc information\* (remaining time)
  - off (Track information (elapsed time))
- (\*not available during the program / random playback)



- off (File information (elapsed time))
- File name information
- off (File information (elapsed time))



- off (File information (elapsed time))
- File name information
- Tag information (title name)
- Tag information (artist name)
- off (File information (elapsed time))



- off → File information → File name information → off

## ■ Chapter information

<Title/Chapter information for BD and AVCHD>



<Chapter information for DVD>



- 1 Current title number
- 2 Current chapter number / Total number of chapters
- 3 Current repeat setting (Only when repeat setting is active)  
(C: Chapter repeat, T: Title repeat, AB : A-B repeat)
- 4 Indicates that the multi camera angle images are available on the scene
- 5 Current playback status
- 6 Elapsed time (or remaining time) of the current chapter

## ■ Title information

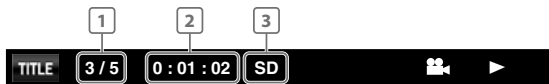

- 1 Current title number / Total number of titles
- 2 Elapsed time (or remaining time) of the current title
- 3 Indication of SD Memory Card playback

## ■ Decoding format information



- 1 Decoding format

## ■ Track/ File information

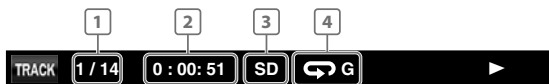

- 1 Current track (file) number / Total number of track (file)
- 2 Elapsed time of the current track or file (or remaining time of the current track or file) (except for JPEG files)
- 3 Indication of SD Memory Card playback
- 4 Current repeat setting (Only when repeat setting is active)  
(T: Track/ File repeat, G: Group repeat, A: All repeat, AB: A-B repeat)

## ■ Disc information



- 1 Current track number / Total number of tracks
- 2 Elapsed time (or remaining time) of the current disc

## ■ File name information



- 1 Media icon and file name

: MP3 file

: WMA file

: JPEG file

## ■ Tag information

<Title name information>



<Artist name information>



- 1 Title name based on tag information of current WMA file
- 2 Artist name based on tag information of current WMA file

# BASIC PLAYBACK

## Playing Back a BD, DVD or a Disc with AVCHD Files

BD-V DVD-V AVCHD

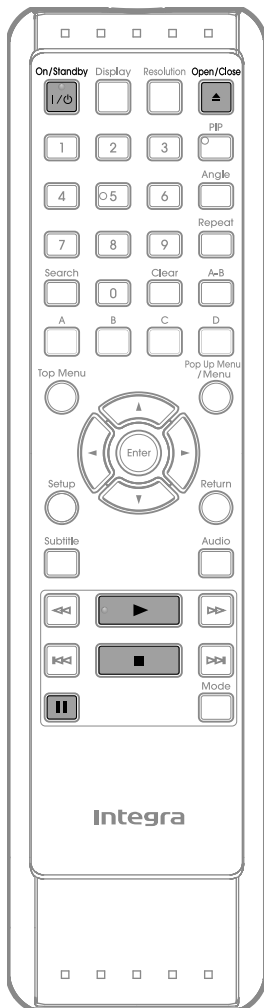

- 1 Press [On / Standby I / ⏻].
- 2 Turn on the TV and select the appropriate input on the TV to which the unit is connected.
- 3 Press [Open / Close ▲] to open the disc tray.
- 4 Place the disc on the disc tray with its label side facing up.

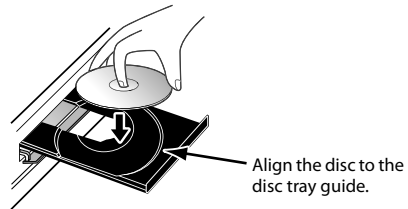

- 5 Press [Open / Close ▲] to close the disc tray.

It may take a while to load the disc.

- 6 **Playback may start automatically.**  
If not, press [Play ▶].  
Some discs may show a title or a disc menu. In this case, refer to "Operations Using Title Menu, Disc Menu, and Pop-up Menu" on page 25.

#### To pause playback:

Press [Pause II].

#### To return to the normal playback:

Press [Play ▶].

#### To stop playback:

Press [Stop ■].

Playback will be in Resume-On-Stop mode.

### Resume-On-Stop mode

If a playback is in Resume-On-Stop mode, when you press [Play ▶] next time, the playback will start from the point where it has been stopped.

#### Note

- Resume playback may not be available for the BD that supports Java applications (BD-Java).
- In the "Disc" mode, the resume information will be cleared when;
  - [Stop ■] is pressed while in the Resume-On-Stop mode.
  - the parental level is changed.
  - the disc tray is opened.
- In the "SD Card" mode, the resume information will be cleared when;
  - [Stop ■] is pressed while in the Resume-On-Stop mode.
  - the SD Memory Card is removed.
  - the unit is turned into the standby mode.

### Note

- Ⓞ may appear at the top-right on the TV screen when the operation is prohibited by the disc or this unit.
- During the playback of 2-layered disc, pictures may stop for a moment. This happens when the 1st layer switches to the 2nd layer. This is not a malfunction.
- BD / DVD / AVCHD menu varies depending on discs.
- If a disc contains AVCHD files, the playback of other files which are in the same disc is not available.
- Set "Still Mode" setting to "Field" in "Video" menu if pictures in the pause mode are blurred (refer to page 44).



## Operations Using Title Menu, Disc Menu, and Pop-up Menu



Many of BD-video and DVD-video disc contains title menu (BD-video/DVD-video/AVCHD), disc menu (DVD-video) or pop-up menu (BD-video) which guides you through the available functions in the disc. The contents of the menus may differ depending on the discs.

### Title menu (BD-video/DVD-video/AVCHD)

- 1 Press [Top Menu].**
  - The title menu will appear.
- 2 Use [▲/▼/◀/▶] to select an item, then press [Enter].**
- 3 Press [Top Menu] to exit.**

### Disc menu (DVD-video)

- 1 Press [Pop Up Menu / Menu].**
  - The disc menu will appear.
- 2 Use [▲/▼/◀/▶] to select an item, then press [Enter].**
- 3 Press [Pop Up Menu / Menu] to exit.**

### Pop-up menu (BD-video)

• This is a special feature available for some BD-videos. When you press [Pop Up Menu / Menu], a menu pops out on the TV screen while the contents still play back.

- 1 During the playback of BD-video, press [Pop Up Menu / Menu].**
  - The pop-up menu will appear.
- 2 Use [▲/▼/◀/▶] to select an item, then press [Enter].**
- 3 Press [Pop Up Menu / Menu] to exit.**

### Note

- Contents of menus and corresponding menu operations may vary among discs. Refer to the manual accompanying the disc for details.
- Title menu is also available for SD card with AVCHD files.

## Playing Back an Audio CD or a Disc with MP3/WMA/JPEG Files

**Before you begin**, make sure the correct media mode is selected. Set "Mode Select" to "Disc".



### 1 Insert an audio CD or a disc with MP3/WMA/JPEG files.

- Media filter screen will appear.
- For audio CD and a disc contains only one type of file, skip to step 3.

#### To return to the first item:

- Press [Top Menu].

#### To return to the track/file played last:

- Press [Pop Up Menu / Menu].

### 2 Select the type of the file you want to play back in the media filter screen. Then press [Enter] to display the file list.

### 3 Use [▲/▼] to select a desired folder or file, then press [Enter]. Use [◀/▶] to go back and forward between the hierarchies. (only for MP3/WMA/JPEG files)

- If you press [Enter] on the desired file, playback will start.

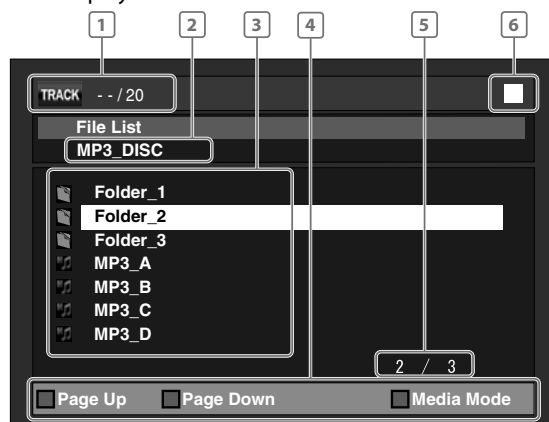

e.g.) MP3

- 1 audio CD** :Track information  
**MP3/WMA/JPEG** :File information
- 2 audio CD** :“CD-DA” will be displayed.  
**MP3/WMA/JPEG** :Current Disc or folder name will be displayed. (Disc or SD Memory Card name will be displayed for the top of the hierarchies.)
- 3 audio CD** :List of the track number and time  
**MP3/WMA/JPEG** :List of the file / folder names in the current folder / disc
- 4 Operation guide** :Press [A] to go to the previous page.  
Press [B] to go to the next page.  
Press [D] to select “Media Mode”.
- 5 Current page / Total page number**
- 6 Playback status**

## Media icon and file name:

 : Folder

 : audio CD track

 : MP3 file

 : WMA file

 : JPEG file

**It is recommended that files to be played back in this unit are recorded under the following specifications:**

### MP3 / WMA

- Sampling frequency: 32 kHz, 44.1 kHz or 48 kHz
- Constant bit rate: 112 kbps - 320 kbps (MP3), 48 kbps - 192 kbps (WMA)

### JPEG

- Upper limit: 2,560 x 1,920 dots (sub sampling is 4:4:4)  
5,120 x 3,840 dots (sub sampling is up to 4:2:2)
- Lower limit: 32 x 32 dots
- File size of image maximum: 12 MB

### Note

- High-resolution JPEG files take longer to be displayed.
- Progressive JPEG files (JPEG files saved in progressive format) cannot be played back in this unit.
- The system can recognize up to 255 folders / 999 files for CD, 999 folders / 9999 files for BD, DVD and SD Memory Card (including the files other than MP3). When number of folder / files exceeds the limit, they will be recognized by the order recorded.
- The name of folder and file can be displayed up to 28 characters. Unrecognizable characters will be replaced with asterisks.
- The 9th and deeper hierarchies cannot be displayed for CD and the 10th and deeper hierarchies cannot be displayed for BD, DVD and SD Memory Card.
- Extension other than listed below cannot be recognized.
  - MP3: ".mp3"
  - WMA: ".wma"
  - JPEG: ".jpg" / ".jpeg"
- Some unplayable folders or files may be listed due to the recording status.
- With regard to the multi-border BD-RE/-R, additionally recorded sections cannot be recognized.
- With regard to the multi-border DVD-RW/-R, additionally recorded sections may not be recognized.
- For the SD Memory Card playback, refer to "Reading the SD Memory Card" on page 26.
- If a disc contains AVCHD files, the playback of other files which are in the same disc is not available.

### Note for JPEG Playback

- Every press on **[Angle]** will turn the image clockwise by 90 degrees when an image is displayed.
- To change the visual effect for switching the playback image, press **[Mode]** once, then use **[◀/▶]** or **[Enter]** to switch between "Cut In/Out" and "Fade In/Out".
- During JPEG playback, press **[Mode]** twice to change the size of the playback image, then use **[◀/▶]** or **[Enter]** to switch between "Normal" (100%) and "Small" (95%). The size change may have no effect on some files (e.g. files with a small picture size).

## Reading the SD Memory Card



You can play back the AVCHD / MP3 / WMA / JPEG files in an SD Memory Card. With the SD Memory Card, you can also enjoy the following functions.

- Special additional contents for BD-ROM Profile 1 ver.1.1. (For more information about the special additional contents, refer to the instruction book that came with the disc.)
- BD-Live function (BD-ROM ver. 2 Profile 2.0). (For more information about BD-Live, refer to page 33.)

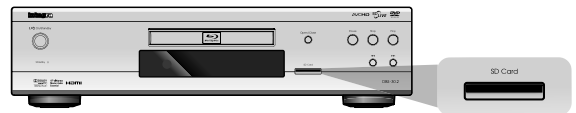

## Setting the Mode Select

For the playback media to be read by this unit, the correct media should be selected. You can switch the media by following the steps below.

**1 In stop mode, press [Setup].**

**2 Use [▲/▼] to select , then press [Enter].**



**3 Use [▲/▼] to select "Mode Select", then press [Enter].**

## 4 Use [▲/▼] to select "SD Card", then press [Enter].

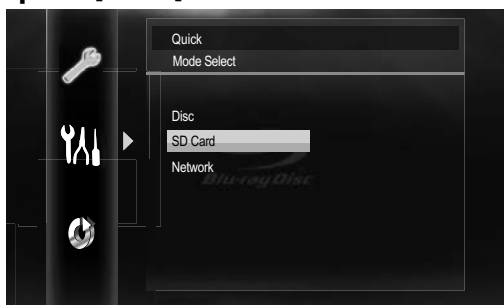

- This will set the unit to "SD Card" mode. To play back the contents in any discs, exit "SD Card" mode by selecting "Disc".

## 5 Press [Setup] to exit.

Even if you turn the unit to the standby mode in "SD Card" mode, it will be in "Disc" mode the next time you turn it on.

### Reading an SD Memory Card

## 1 Insert an SD Memory Card, with the label side facing up, into the SD Card slot until it clicks.

If no disc is in operation, "Media Select" screen will appear on the TV screen.

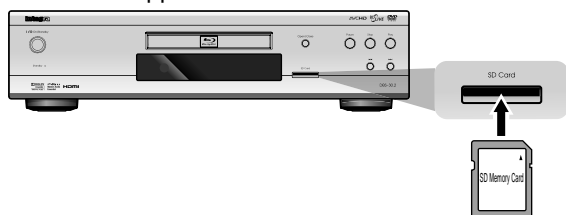

## 2 Use [▲/▼] to select "SD Card", then press [Enter].

- Media filter screen will appear.
- When the SD Memory Card contains only one type of file, skip to step 4.

## 3 Select the type of the file you want to play back in the media filter screen. Then press [Enter] to display the file list.

- Playback of AVCHD files will start right after you choose "Video". (The file list is not available for AVCHD files.)

## 4 Use [▲/▼] to select a desired track, folder or file, then press [Enter]. Use [◀/▶] to go back and forward between the hierarchies.

- If you press [Enter] on the desired file, playback will start.

### To remove the SD Memory Card:

In stop mode, gently push in the SD Memory Card, then pull it out slowly.

### Compatible Cards:

- SD Memory Card (8MB - 2GB)
- SDHC Memory Card (4GB - 8GB)
- miniSD Card (8MB - 2GB)
- microSD Card (8MB - 2GB)
- For miniSD Card and microSD Card, the adapter will be required.

### Note

- The "Media Select" screen will disappear under the conditions listed below:
  - when [Return] is pressed.
  - when the setup menu is called up.
- **Do not remove the card during its playback.**
- This unit supports SD Memory Card with FAT12/FAT16 file system, and SDHC Memory Card with FAT32 file system.
- Do not delete the folders or files in the SD Memory Card with your computer. This unit might not read SD cards formatted on a computer.
- This unit recognizes up to 8 characters (including "~1") of file name in the SD Memory Card. Characters after 8th will not be displayed.
- If a folder or file name includes one of the following unrecognizable characters, the folder or file name may not be displayed correctly.
  - Unrecognizable characters: ., " = + [ ] ; / \ : ¥
- For an SD Memory Card, extension other than listed below cannot be recognized.
  - MP3: ".mp3"
  - WMA: ".wma"
  - JPEG: ".jpg"
  - "jpeg" is not available for SD Memory Card.

## Playing Video/Music/Photo Files from DLNA Certified Home Media Servers



On this unit, you can play video, music and photo files stored on DLNA certified home media servers (version 1.5) connected to your home network. In order to use this feature, you must connect this unit to the Internet.

This unit can be used only as DMP(Digital Media Player).

**1 Connect this unit to the Internet.**  
 • Refer to "Network Connection with LAN" on page 19.

**2 Set up the necessary network connection settings.**  
 • Refer to "Network Connection" on pages 52-55.

**3 Start DLNA home media servers in your home network.**  
 • For details, refer to the owner's manual of the DLNA certified device.

**4 Press [D] while opening screen is displayed.**  
 • For opening screen, refer to page 12.  
 • This unit will start loading the home server list.  
 • To cancel loading, press [Stop ■].  
 • To reload the home server list, press [D].

**5 After loading, home server list will appear. Select a home server you want to access, then press [Enter].**

**6 File list of the selected home server will appear. Select a file you want to play back, then press [Play ►] or [Enter] to start playback.**

• If you select a folder, select a file in the folder and then press [Play ►] or [Enter] to start playback.

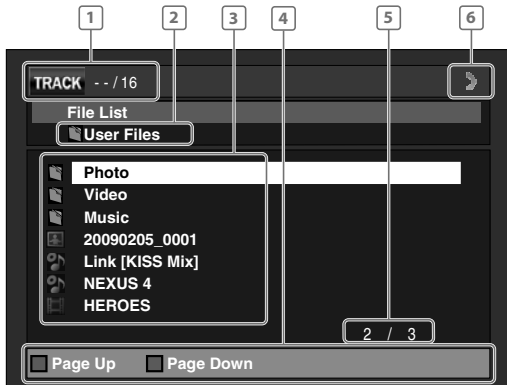

- 1 File information
- 2 Current folder name will be displayed.
- 3 List of the file / folder names in the current folder
- 4 Operation guide :Press [A] to go to the previous page.  
Press [B] to go to the next page.
- 5 Current page / Total page number
- 6 Playback status

• To control the playback, use following buttons.

Button	Action
Skip  ◀◀/▶▶	Skip to the previous / next file during playback or in pause mode
Pause	Pause the playback
Play ►	Return to the normal playback
Stop ■	Stop the playback (For video files, playback will be in Resume-On-Stop mode.) <Resume-On-Stop mode for video files> Playback will start from the point where it is stopped next time you press [Play ►]. If you press [Enter] instead of [Play ►], playback will start from the beginning of the file instead of resuming from the stop point.

### Note

- For the home server list, maximum of 10 servers can be displayed.
- The system can recognize up to 9,999 files (including folders).
- The 10th and deeper hierarchies cannot be displayed.
- This unit supports following formats. (Formats other than listed below cannot be recognized.)
  - Video : MPEG 1  
MPEG 2 PS  
MPEG 2 TS /TTS
  - Music : LPCM  
MP3  
WMA
  - Photo : JPEG
- Unplayable files in the home server will not be displayed in the file list.
- For some files, playback is not available even if displayed in the file list.
- In order to play back the contents in home servers, the player and the servers must be connected to the same access point.
- Compatibility and available playback function may differ depending on the home server.
- If you select a photo file in step 6, the selected file will be played back and go to the next file in the current hierarchy in turn every 10 seconds.
- For photo files, every press on [Angle] will turn the image clockwise by 90 degrees when an image is displayed.
- For a folder contains only photo files, file list or thumbnail list will be displayed, depending on the information from the home server.
- Video files with unsupported audio format will be skipped.
- The quality of the playback picture or audio differs depending on your network condition.

# BASIC PLAYBACK

## DLNA Client (DMP) Our Planning Specification

Items	Description		
DLNA version	1.5		
Video file	System Stream	Video Codec type	Audio Codec type
	MPEG1	MPEG1-Video	MPEG
	MPEG2-PS	MPEG2 MP@ML(SD)	LPCM/Dolby - AC3/MPEG
Audio file	MPEG2-TS/TTS	MPEG2 MP@HL(HD) MPEG2 MP@ML(SD)	Dolby - AC3
	Audio Codec type	Sampling Frequency	Bit rate
	LPCM	44.1k, 48kHz	—
	MP3 (MPEG1 Layer3)	32k, 44.1k, 48kHz	32k - 320k bps
	MP3 (MPEG2 Layer3)	16k, 22.05k, 24kHz	8k - 160k bps
Image file	MP3 (MPEG2.5 Layer3)	8k, 11.025k, 12kHz	8k - 160k bps
	WMA	8k, 11.025k, 16k, 22.05k, 32k, 44.1k, 48kHz	5k - 320k
JPEG	YCbCr = 4 : 2 : 0/4 : 2 : 2 Color depth = 24	Resolution : 5120 x 3840 or less File format : Exif	

## DLNA Playback Format

Items	Supported Bitrate (DLNA certification criterion)		
Video file	MPEG1	MPEG1-Video	1,411,200bps
	MPEG2-PS	MPEG2 MP@ML(SD)	10.08Mbps
	MPEG2-TS/TTS	MPEG2 MP@HL(HD)	19.3927Mbps
MPEG2 MP@ML(SD)		19.3927Mbps	
Audio file	LPCM	44.1kHz Mono	705.6kbps
		44.1kHz Stereo	1411.2kbps
		48.0kHz Mono	768kbps
		48.0kHz Stereo	1536kbps
	MP3 (MPEG1 Layer3)	Mono	32 - 160kbps
		Stereo	64 - 320kbps
	MP3 (MPEG2 Layer3)	Mono	8 - 80kbps
		Stereo	16 - 160kbps
	MP3 (MPEG2.5 Layer3)	Mono	8 - 80kbps
		Stereo	8 - 160kbps
WMA	8 - 48kHz Stereo	5 - 320kbps	
Image file	JPEG	Exif Ver.2.21	—

## DLNA Error Code

Error Code appears in the error screen when the unit detects an error, as shown below. The code is used to specifically determine the cause of error.

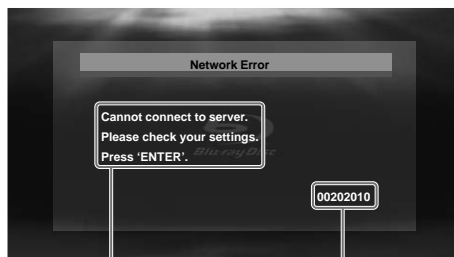

e.g.) Error Code

Error Code are displayed with "[\*\*\*\*\*]" ("\*" is error code) as shown above.

### Error Code Form

In the Home Network (DLNA), Error Code are used as follows.



"Summary Error Code" are shown in the list below.

Summary Error Code	Error message
02	Cannot connect to server. Please check your settings.
03	Playback Error
05	No playable files found.
20	System Error
21	Unable to display files from the server. Please check server settings.
22	List Updated.
23	Connection with server lost.
24	Unable to connect to more than 10 servers. Please turn off or stop broadcasting 1 or more servers.

**If you would like to contact us about Home Network service, please confirm the Detailed Error Code.**

# SPECIAL PLAYBACK

## Fast Forward / Fast Reverse



### 1 During playback, press [Fwd ►►] repeatedly for fast forward.

During playback, press [Rev ◀◀] repeatedly for fast reverse.

Every time you press [Fwd ►►] or [Rev ◀◀], the playback speed will change.

### 2 Press [Play ►] to return to normal playback.

#### Note

- For BD, DVD and AVCHD, speed changes in 5 different levels.
- For audio CD, MP3, WMA and video / music files on DLNA home server, speed changes in 3 different levels.
- For audio CD, fast forward / fast reverse search between different tracks are not available during program and random playback.
- For MP3, WMA and video / music files on DLNA home server, fast forward / fast reverse search between different files are not available.
- For some video / music files on DLNA home server, fast forward / fast reverse may not function.

## Slow Forward Playback



### 1 During playback, press [Pause ||], then press [Fwd ►►].

Every time you press [Fwd ►►], playback speed will change.

### 2 Press [Play ►] to return to normal playback.

#### Note

- Slow forward speed changes in 3 different levels.
- Only slow forward is available.
- Set "Still Mode" setting to "Field" in "Video" menu if pictures in the slow forward playback mode are blurred (refer to page 44).
- For some video files on DLNA home server, slow forward may not function.

## Step by Step Playback



### 1 In pause mode, press [Pause ||] repeatedly.

Every time you press [Pause ||], playback will advance one step at a time.

### 2 Press [Play ►] to return to normal playback.

#### Note

- Only step by step forward is available.
- Set "Still Mode" setting to "Field" in "Video" menu if pictures in step by step playback mode are blurred (refer to page 44).

## Repeat Playback

Available repeat functions vary depending the discs.

### 1 During playback, press [Repeat] repeatedly to select the desired repeat mode.

Repeat mode	Available media
<b>Chapter repeat</b>	BD-V, DVD-V, AVCHD
The current chapter will be played back repeatedly.	
<b>Title repeat</b>	BD-V, DVD-V, AVCHD
The current title will be played back repeatedly.	
<b>Track repeat</b>	CD, MP3, WMA, DLNA VIDEO, DLNA MUSIC
The current track or file will be played back repeatedly.	
<b>Group repeat</b>	MP3, WMA, JPEG, DLNA VIDEO, DLNA MUSIC, DLNA PHOTO
The current folder will be played back repeatedly.	
<b>All repeat</b>	CD, MP3, WMA, JPEG
All tracks or files in the media will be played back repeatedly.	

#### Note

- The repeat setting will be canceled when you stop playback.
- The chapter, title, track or group repeat will be cleared when moving to other chapter, title, track / file or folder.
- Repeat playback does not function during A-B repeat playback.
- Chapter and title repeat are not available with some scenes.
- When the repeat setting is set for a MP3 or WMA folder (file), the repeat setting will be cancelled if you select other MP3 or WMA folder (file) to playback.
- For some video / music / photo files on DLNA home server, repeat playback may not function.

## A-B Repeat



You can play back the specific part (between point A and point B) repeatedly.

**1 During playback, press [A-B] at the desired starting point A.**

**2 During playback, press [A-B] at the desired ending point B.**

As soon as you set the point B, the part between point A and point B will start playback repeatedly.

- To cancel the A-B repeat, press [A-B] again.

### Note

- Point B should be set within the same title or track as point A.
- A-B repeat is not available with some scenes.
- To cancel the A point which was set, press [Clear].
- A-B repeat does not function during chapter, title, track, group or all repeat playback.
- For some video files on DLNA home server, A-B repeat playback may not function.

## PIP (Picture in Picture) (BONUSVIEW) Setting



Some BD-videos have the PIP (picture-in-picture) function which enables you to display the secondary video in the primary video. You can call up the secondary video by pressing [PIP] whenever the scene contains the secondary video.

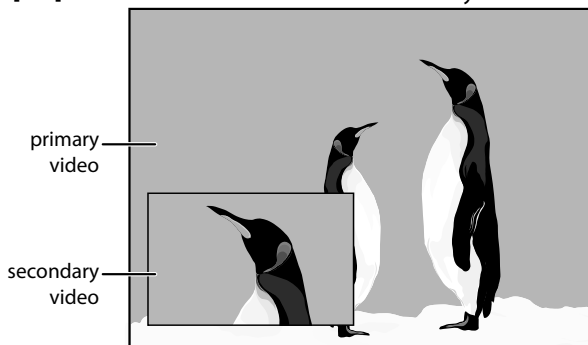

**1 During playback, press [PIP].**

PIP information will appear.

**2 Use [▲/▼] to select the secondary video you want.**

- The secondary video will be displayed and the secondary audio will be output.
- Use [◀/▶] to switch between current setting and "Off".

**3 Press [Return] or [PIP] to remove the PIP information.**

### Note

- [Mode] can also be used instead of [PIP].
- The secondary audio will not be output when the secondary audio is set to "Off" or when "BD Audio Mode" is set to "HD Audio Output". Refer to "Switching Audio Soundtrack" on page 35 and "Setting the BD Audio Mode" on page 36.

## Program Playback



You can play back the disc in your desired order.

**1 In stop mode, press [Mode].**

- The program screen will appear.

**2 Use [▲/▼] to select a track / folder / file, then press [Enter].**

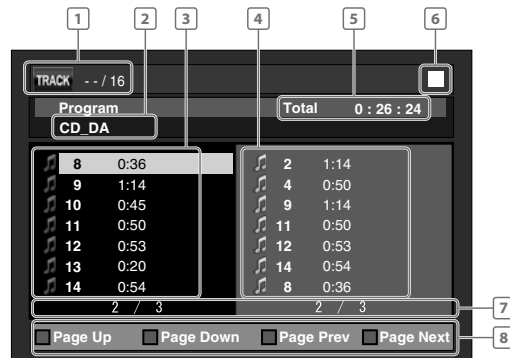

e.g.) audio CD

- 1 audio CD** :Track information  
MP3/WMA/JPEG :File information
- 2 audio CD:** :“CD-DA” will be displayed.  
MP3/WMA/JPEG :Current disc or folder name will be displayed.
- 3 Track /Folder / File list:** :Track /folder / File list in the original order
- 4 Programmed list** :Track /File list in the programmed order
- 5 Cumulative playback time of all tracks in the programmed list (audio CD only)**
- 6 Playback status**
- 7 Current page / Total page number**
- 8 Operation guide** :Press [A] to go to the previous page in the track / file list.  
Press [B] to go to the next page in the track / file list.  
Press [C] to go to the previous page in the programmed list.  
Press [D] to go to the next page in the programmed list.

- For MP3, WMA or JPEG files, use [▲/▼] to select a folder, then press [Enter] first, and then use [▲/▼] to select a file, then press [Enter].
- Press [Clear] to erase the last file of the program.
- Use [▲/▼] to select "All Clear" at the bottom of the list to erase all the tracks / files in the program.
- The programmed tracks / files is displayed in the right hand screen.
- Use [◀/▶] to go back forward between the hierarchy of folders.

## 3 Press [Play ▶] to start program playback.

- Program playback will start.

### To exit from the program playback mode:

- Press [Return] in stop mode.

### Note

- During program playback, press [Stop ■] once to set the resume point, and then press [Play ▶] to resume program playback from where [Stop ■] was pressed (audio CD) or from beginning of the file where [Stop ■] was pressed (MP3/WMA/JPEG).
- During program playback, press [Stop ■]. To go back to the normal program playback, press [Return] to exit from the program screen, then press [Play ▶].
- The program will be cleared when;
  - the unit is turned into the standby mode.
  - the media mode is switched to the other mode.
  - the disc / card is removed. (as for "Disc" mode, just opening the disc tray will clear the program info.)
- Up to 99 tracks/files can be entered.
- To repeat the current track / file in the program, press [Repeat] repeatedly until "Track" appears during playback. To repeat the entire program, press [Repeat] repeatedly until "All" appears during playback.
- Even if an inserted disc contains mixed MP3, WMA and JPEG files, program function allows 99 files in combination of MP3 and WMA files.
- Playback from a desired track / file and random playback are not available during program playback.
- Press [Mode] to switch to the random playback mode.

## Random Playback



This function shuffles the playback order of tracks/files.

### 1 In stop mode, press [Mode] twice.

- The random screen will appear.

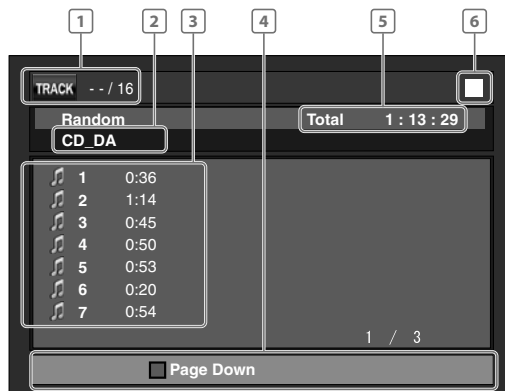

e.g.) audio CD

- audio CD** :Track information  
MP3/WMA/JPEG :File information
- audio CD** :“CD-DA” will be displayed.  
MP3/WMA/JPEG :Current disc, SD Memory Card, or folder name will be displayed.
- Track / File list** :Track / File list in the original order
- Operation guide** :Press [A] to go to the previous page in the track / file list.  
Press [B] to go to the next page in the track / file list.
- Total playback time of all tracks (audio CD only)**
- Playback status**

### 2 Press [Play ▶] to start random playback.

#### To exit from the random playback mode:

- Press [Mode] in stop mode.

### Note

- During the random playback, press [Stop ■] once to set the resume point, and then press [Play ▶] to resume random playback from where [Stop ■] was pressed (audio CD) or from beginning of the file where [Stop ■] was pressed (MP3/WMA/JPEG).
- During random playback, press [Stop ■]. To cancel the random playback, press [Mode] when the random playback screen is displayed.
- Up to 99 tracks / files can be entered.
- To repeat the current track / file in the random selection, press [Repeat] repeatedly until "Track" appears during playback. To repeat the entire random selection press [Repeat] repeatedly until "All" appears during playback.
- You cannot go back to the previous track / file during random playback.
- For a disc containing mixed MP3 and WMA files, random playback of those files will be performed.



## Rapid Playback



This function plays back approximately at 1.3 times the normal playback while keeping the sound output. This function is available only on discs recorded in the Dolby Digital format.

- 1 During playback, press [Mode] repeatedly until the Rapid playback setting appears.**



- 2 Press [Enter] or [◀/▶] to switch ♪♪ (x1.3), or off.**

“Off”: Plays back in normal speed.

“♪♪”: Plays back approximately at 1.3 times of normal playback.

- 3 Press [▶] to return to normal playback.**

### Note

- Picture adjustment and audio language setting cannot be changed during this function.
- This function may not work at some points on a disc.
- During this function, 2ch LPCM will be output from HDMI OUT jack and AUDIO OUTPUT (DIGITAL OPTICAL/COAXIAL) jacks.

## Camera Angle



Some BD-videos and DVD-videos contain scenes which have been shot simultaneously from various angles. You can change the camera angle when  appears on the TV screen.

- 1 During playback, press [Angle].**
  - The selected angle will be displayed on the display bar at the top of the TV screen.
- 2 Use [▲/▼] to select your desired angle.**



### Note

- If “Angle Icon” setting is “Off” in “Others” menu,  will not appear. Refer to page 50.

## Enjoying BD-Live Discs with Internet



You can enjoy BD-Live which enables you to use interactive features when the unit is connected to the Internet. (For the network connection, refer to pages 52-55.)

Examples of BD-Live features:

- Online access to additional content such as movie trailers, subtitles, BD-Java applications, etc.
- While downloading, special video data may be played back.

### How to Activate the BD-Live Function

- 1 Insert the disc with BD-Live function.**
- 2 Insert an SD card with enough capacity. (SD card of 1GB or more is recommended.)**
  - Make sure to use the SD card with the supported file system. (Refer to “Note for SD Memory Cards” on page 21)
- 3 Press [Top Menu] to access the disc menu.**
- 4 Select “BD-Live”, then press [Play ▶] or [Enter].**
  - Make sure the SD card is correctly inserted, and do not remove the card during playback.
  - Service and functions differ depending on the disc. Follow the instructions given by the disc when using the BD-Live function.

### Note

- You must connect the unit to the Internet and set up necessary settings in order to use BD-Live.
- For certain discs, “BD-Live Setting” may need to be changed.
- Depending on your connection environment, it may take time to connect to the Internet or the Internet may not be connected.
- When BD-Live functions are used and the unit is connected to the Internet, you may be charged for this communication.
- While connecting to BD-Live, sometimes it can take awhile before the next page is downloaded or refreshed.
- Some discs with BD-Live function require memory when play back the content. If you cannot play back a disc with BD-Live function, insert an SD card (1GB or more) which is formatted on this unit.

### Note for AACs Online

- The player or disc IDs may be sent to the content provider when playing back a disc with BD-Live function.
- If you save your viewing history on the server by using these IDs, you will be introduced to other similar movies.
- You can save game score histories.

## Using [Skip ◀◀/▶▶]

- 1 During playback, press [Skip ▶▶] to move to the next track. Press it repeatedly to skip to subsequent tracks. Press [Skip ◀◀] once to go back to the beginning of the current track. Press it repeatedly to go to the previous tracks.

















- For JPEG files, press [Skip ◀◀] once to go back to the previous file.

### Note

- For BD and DVD, if title contains no chapters, [Skip ◀◀/▶▶] changes the title.
- For JPEG files, [◀/▶] is also available.

## Using [Search]

By using [Search], you can select following search modes.

Search mode	Available media
 <b>Chapter / Title search</b>	  
 <b>Track search</b>	    
 <b>Time search</b>	    

- 1 During playback, press [Search] repeatedly until your desired search mode appears.
- 2 Enter the desired chapter, title, track, file number or time to search for using [the Number buttons].
  - Chapter, title, track or time search will start.
  - Press [Clear] to erase an incorrect input.

### Note

- During program and random playback, search functions are not available except the search using [Skip ◀◀/▶▶].
- Time search is available only in the same track, file or title.
- For BD / AVCHD, chapter and time search are available only during playback.
- For some video files on DLNA home server, time search may not function.

## Using [the Number buttons] (Direct Search)

### Title Search

In stop mode, enter the title number you want to search using [the Number buttons].

Playback of the title will start in a few seconds.

### Chapter Search

During playback of a title, enter the chapter number you want to search using [the Number buttons].

Playback of the chapter will start in a few seconds.

### Track / File Search

Enter the track / file number you want to search using [the Number buttons].

Playback of the track / file will start in a few seconds.

### Note

- As for the BD-video, how it performs will be strongly determined by the disc, and may not perform as described here.

# SPECIAL SETTINGS

You can select the format of audio and video as you prefer depending on the contents of the disc you are playing back.

## Switching Subtitles

Some video materials may have subtitles in 1 or more languages. For commercially available discs, the supported languages can be found on the disc case. Follow the steps below to switch the subtitle language during playback.

BD-V

- 1 During playback, press [Subtitle].
- 2 Use [▲/▼] to select "Primary Subtitle", "Secondary Subtitle" or "Subtitle Style", then press [Enter].

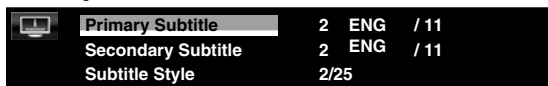

"Primary Subtitle" :Sets the subtitle for the primary video.

"Secondary Subtitle" :Sets the subtitle for the secondary video.

"Subtitle Style" :Sets style of the subtitle.

- 3 Use [▲/▼] to select your desired subtitle or style.

• Use [◀/▶] to switch between current subtitle setting and "Off".

- 4 Press [Subtitle] to exit.

DVD-V AVCHD

- 1 During playback, press [Subtitle].
- 2 Use [▲/▼] to select your desired subtitle.



• Use [◀/▶] to switch between current subtitle setting and "Off".

- 3 Press [Subtitle] to exit.

### Note

- Some discs will only allow you to change the subtitles from the disc menu or pop-up menu. Press [Top Menu] or [Pop Up Menu / Menu] to display the disc menu or pop-up menu.
- If 4-digit-language code appears in the subtitle menu, refer to "LANGUAGE CODE" on page 61.
- If the disc has no subtitle language or subtitle style, "Not Available" will be displayed on the TV screen.
- During playback of the secondary video, the primary subtitle setting is not available except when there is no subtitle for the secondary video.
- Secondary subtitle setting is only available during playback of the secondary video.
- If you choose a language that has a 3-letter-language code, the code will be displayed every time you change the subtitle language setting. If you choose any other Languages, "----" will be displayed instead (refer to page 61).

## Switching Audio Soundtrack

When playing back video material recorded with 2 or more soundtracks (these are often in different audio languages or audio formats), you can switch them during playback.

BD-V

- 1 During playback, press [Audio].
- 2 Use [▲/▼] to select "Primary" or "Secondary" audio to set, then press [Enter].

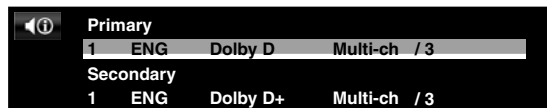

"Primary" :Sets the audio for the primary video.

"Secondary" :Sets the audio for the secondary video.

- 3 Use [▲/▼] to select your desired audio stream channel.

• For "Secondary", use [◀/▶] to switch between current audio setting and "Off".

- 4 Press [Audio] to exit.

DVD-V CD AVCHD

- 1 During playback, press [Audio].
- 2 Use [▲/▼] to select your desired audio stream channel.



e.g.) DVD-video

• For audio CD, you can select following options.

"Stereo" :Both right and left channels are active (stereo).

"L-ch" :Only left channel is active.

"R-ch" :Only right channel is active.

- 3 Press [Audio] to exit.

### Note

- The secondary audio will not be output when the secondary video is not displayed or when "BD Audio Mode" is set to "HD Audio Output".(For some BD, secondary audio will be output even when secondary video is off.)
- The sound mode cannot be changed during playback of discs not recorded in multiple audio.
- Some discs allow to change audio language setting on the disc menu. (Operation varies depending on the discs. Refer to the manual accompanying the disc.)
- [Audio] may not work on some discs with multiple audio streams or channels (e.g. DVD which allow to change audio setting on the disc menu).
- If you select a language that has a 3-letter-language code, the code will be displayed every time you change the audio language setting. If you select any other languages, "----" will be displayed instead (refer to page 61).
- If 4-digit-language code appears in the subtitle menu, refer to "LANGUAGE CODE" on page 61.
- If the disc has no audio language, "Not Available" will be displayed on the TV screen.
- For DTS-CD (5.1 music disc), "DTS" will be displayed. (Selecting audio streams or channels is not available.)

## Setting the BD Audio Mode

BD-V

There are 2 ways to set "BD Audio Mode" setting; whether to output the secondary and interactive audio accompanied by the primary audio or only the primary audio. Depending on the setting of the mode, Dolby Digital, Dolby Digital Plus, Dolby TrueHD, DTS, or DTS-HD output changes between multi LPCM and Bitstream.

- 1 In stop mode with BD inserted, press [Mode].
- 2 Use [▲/▼] to select your desired setting.



### "Mix Audio Output":

If it is available, BD-video's secondary and interactive audio will be output with the primary audio.

- The secondary audio is the audio for the secondary video (Director's comment etc.) and the interactive audio is the audio for the interactive application (Button click sounds etc.).

### "HD Audio Output":

Only the primary audio will be output. Set this mode in order to output Dolby Digital, Dolby Digital Plus, Dolby TrueHD, DTS or DTS-HD audio of BD through HDMI connection.

- 3 Press [Return] to exit.

- You can also set "BD Audio Mode" from the setup menu. Refer to page 45.

### Note

- In "Mix Audio Output" mode, if there is no secondary and interactive audio, the audio will be output as "HD Audio Output" mode.
- In "Mix Audio Output" mode, even if you set "HDMI Multi(Normal)" in "HDMI Audio Out" setting, multi LPCM will be output from HDMI OUT jack for BD audio. Refer to page 15.
- In "Mix Audio Output" mode with HDMI audio being output, 2-channel down-mixed LPCM will be output from AUDIO OUTPUT (DIGITAL OPTICAL / COAXIAL) jacks for BD audio.
- In "Mix Audio Output" mode with "HDMI Audio Out" setting set to "Audio Mute" and "Digital Out" setting set to "Bitstream", DTS®, DTS-HD® and LPCM will be output as Dolby Digital for BD audio. Refer to pages 15, 18.
- You can also set "BD Audio Mode" setting from the setup menu. Refer to page 45.

## Adjusting the Picture

BD-V DVD-V AVCHD DLNA-VIDEO

You can adjust the picture quality and store the setting you have adjusted on memory 1-5.

- 1 During playback, press [Mode] repeatedly until the picture adjustment menu appears.



- 2 Use [▲/▼] to select a memory from "Memory 1" to "Memory 5" to store your setting, then press [Enter].
- 3 Use [▲/▼] to select a item to be adjusted, then use [◀/▶] or [Enter] to adjust the setting.



Item	Description	Adjustment range
1. Contrast	Adjusts the difference between the bright and dark parts of the picture.	-7 to +7(0*)
2. Brightness	Adjusts the brightness of the picture.	0 to +15(0*)
3. Sharpness	Adjusts the sharpness of the picture for frequency range.	-6 to +6(0*)
4. Gamma Correction	Detailed adjustment of the picture's brightness.	0 to +5(0*)
5. Color	Adjusts the balance between green and red.	-7 to +7(0*)
6. Black Level* <sup>1</sup>	Adjusts the black level.	On*:Makes the dark parts brighter. Off :Shows the original picture as recorded.
7. Noise Reduction	Reduces the noise of the playback picture.	On :Activates the Noise Reduction. Off*:Deactivates the Noise Reduction.

\* Default setting

\*<sup>1</sup> Not effective for the video signal of VIDEO OUTPUT (COMPONENT) jacks (480i) and HDMI OUT jack.

### Note

- The setting remains even you turn the unit into the standby mode except unplug the AC cord.
- Adjusting the picture is effective for HDMI OUT jack, VIDEO OUTPUT (COMPONENT) jacks and VIDEO OUTPUT (VIDEO) jack.

# NETFLIX OPERATIONS

With this unit, you can watch movies and TV episodes streamed instantly from Netflix (version 1.6) via the Internet. In order to use this feature, you must visit the following website on your PC and become a Netflix member.

[netflix.com/Integra](http://netflix.com/Integra)

## Before Activating the Connection to Netflix

After creating a Netflix account at [netflix.com/Integra](http://netflix.com/Integra), follow the following procedure before activating the connection to Netflix.

### 1 Connect this unit to the Internet.

- Refer to "Network Connection with LAN" on page 19.

### 2 Set up the necessary network connection settings.

- Refer to "Network Connection" on pages 52-55.

## Activating the Connection to Netflix

In order to watch movies and TV episodes streamed instantly from Netflix via the Internet, you must activate the connection between this unit and your Netflix account.

### 1 Press [A] while opening screen is displayed.

- For opening screen, refer to page 12.
- Netflix welcome screen will appear.
- For the first time only, "Network Service Disclaimer" screen will appear. After confirming the content, use [◀/▶] to select "Agree", then press [Enter].

### 2 Use [▲/▼] to select "yes - activate instant streaming from Netflix", then press [Enter].

- Activation screen with the activation code will appear.



### 3 On your PC, visit [netflix.com/activate](http://netflix.com/activate) and log into your account.

- The entry screen of activation code will appear on your PC screen.

### 4 Enter the activation code which is displayed on the TV screen.

- The instant Queue will appear.
- The connection to Netflix is successfully made.
- To browse the instant Queue and watch movies, skip to step 2 in "Watching Streaming Movies" on page 37.

## Note

- Netflix is available only in the United States.
- You cannot create a Netflix account on this unit.
- If newer version of software is required, software update screen may appear after selecting "NETFLIX" in step 1.  
(For software update, refer to "Software Update" on page 55.)
- You can deactivate the connection to Netflix by setting the "Netflix Deactivate" to "Yes". (Refer to page 56.)
- The screen image of Netflix may change after updating the firmware.
- For questions regarding the Netflix service, visit [netflix.com/Help](http://netflix.com/Help)
- When you contact the Netflix customer service, you may be asked for the ESN number, which is a serial number to identify this unit by Netflix. You can check the ESN number on the bottom of the "Netflix Deactivate" screen. (Refer to page 56.)

## Watching Streaming Movies

After you set up the connection to Netflix, you can browse the instant Queue and watch movies on your TV.

### 1 Press [A] while opening screen is displayed.

- For opening screen, refer to page 12.
- The instant Queue will appear.

### 2 Use [◀/▶] to select the desired movie or TV episode, then press [Play ▶] to start playback.

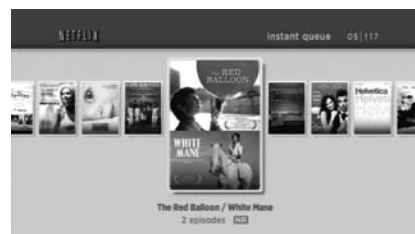

- After loading, playback of the selected movie or TV episode will start.
- To stop the playback, press [Stop ■].
- To go back to the instant Queue, press [A].
- To go back to the opening screen, press [Top Menu] or [Setup].

## About the Instant Queue

- Instant Queue is the list of movies and TV episodes you add on the Netflix website. ([netflix.com](http://netflix.com)) You can manage the movies and TV episodes in your instant Queue from the Netflix website on your PC.
- You cannot add movies or TV episodes to your instant Queue on this unit.
- You can remove movies or TV episodes from the instant Queue on this unit.

## Note

- The picture quality differs depending on the speed of your Internet connection at the time of loading.

# CINEMANOW / BLOCKBUSTER OPERATIONS

With this unit, you can watch movies and TV episodes streamed instantly from CinemaNow/Blockbuster via the Internet. In order to use this feature, you must visit the following website and create a CinemaNow/Blockbuster account.

- For CinemaNow, visit [www.cinemanow.com/Login](http://www.cinemanow.com/Login)
- For Blockbuster, visit [www.blockbuster.com/auth/login](http://www.blockbuster.com/auth/login)

## Before Activating the Connection to CinemaNow / Blockbuster

After creating a CinemaNow/Blockbuster account, follow the following procedure before activating the connection to CinemaNow/Blockbuster.

- 1 Connect this unit to the Internet.**
  - Refer to "Network Connection with LAN" on page 19.
- 2 Set up the necessary network connection settings.**
  - Refer to "Network Connection" on pages 52-55.

## Activating the Connection to CinemaNow / Blockbuster

In order to watch movies and TV episodes streamed instantly from CinemaNow/Blockbuster via the Internet, you must activate the connection between this unit and your CinemaNow/Blockbuster account.

- 1 On your PC, visit following website and log into your account to get the activation code.**
  - Follow the instruction given by the website.
  - Take a note of the activation code which appears on the PC.

- For CinemaNow, visit [www.cinemanow.com/activate](http://www.cinemanow.com/activate)
- For Blockbuster, visit [www.blockbuster.com/Integra](http://www.blockbuster.com/Integra)

- 2 On this unit, press [B] or [C] while opening screen is displayed.**
  - For opening screen, refer to page 12.
  - Menu screen of CinemaNow or Blockbuster will appear.
  - For the first time only, "Network Service Disclaimer" screen will appear. After confirming the content, use [◀/▶] to select "Agree", then press [Enter].

- 3 Use [◀/▶] to select "Settings" (CinemaNow) or "Configure" (Blockbuster), then press [Enter].**
  - For CinemaNow, select "Activate" and press [Enter] again in the next screen.
  - Activation code input screen will appear.

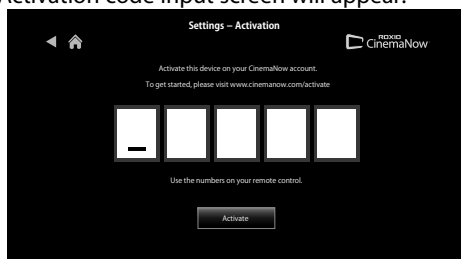

e.g.) CinemaNow

- 4 Enter the activation code displayed on your PC using [◀/▶] and [the Number buttons], then select "Activate" and press [Enter].**
  - For CinemaNow, confirmation message will appear. Press [Enter] to complete the setting.

## Note

- The image of menu screen may change after updating the firmware.
- You cannot create CinemaNow/Blockbuster account on this unit.
- To deactivate the connection to CinemaNow or Blockbuster, select "Deactivate" in "Settings" (CinemaNow) or "Configure" (Blockbuster).
- For questions regarding CinemaNow service, visit [www.cinemanow.com/support](http://www.cinemanow.com/support)
- For questions regarding Blockbuster service, visit [www.blockbuster.com/help](http://www.blockbuster.com/help)

## Guide to CinemaNow / Blockbuster Menu Screen

### CinemaNow

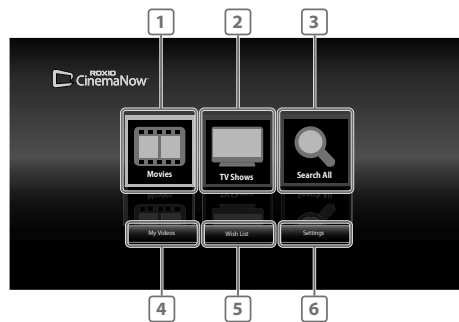

### Blockbuster

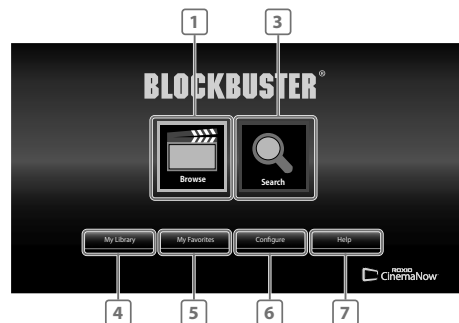

- |          |                                 |  |
|----------|---------------------------------|--|
| <b>1</b> | <b>Movies / Browse</b>          | <b>:To access the movie list</b>                                       |
| <b>2</b> | <b>TV Shows</b>                 | <b>:To access the TV show list</b>                                     |
| <b>3</b> | <b>Search All / Search</b>      | <b>:To access search screen</b>  |
| <b>4</b> | <b>My Videos / My Library</b>   | <b>:To access the list of rented or purchased movies / TV episodes</b> |
| <b>5</b> | <b>Wish List / My Favorites</b> | <b>:To access your wish list / favorite list</b>                       |
| <b>6</b> | <b>Settings / Configure</b>     | <b>:To access setting / configure menu</b>                             |
| <b>7</b> | <b>Help</b>                     | <b>:To access the help page</b>  |

## Renting or Purchasing Movies / TV Episodes

After you set up the connection to CinemaNow/Blockbuster, you can rent or purchase movies/TV episodes and watch directly on your TV.

- 1 Press [B] or [C] while opening screen is displayed.**
  - For opening screen, refer to page 12.
- 2 Use [▲/▼/◀/▶] to select "Movies", "Browse" or "TV Shows", then press [Enter].**
  - List of movies/TV episodes will appear.
- 3 Use [▲/▼/◀/▶] to select the desired title, then press [Enter].**
  - Title details screen of the selected title will appear.
- 4 Use [◀/▶] to select "Rent" or "Buy", then press [Enter].**
  - Checkout screen will appear.
- 5 Use [◀/▶] to select "Submit Order", then press [Enter].**
- 6 Use [◀/▶] to select "Watch Now", then press [Enter].**
  - If you want to continue browsing, select "Continue Browsing" and press [Enter] to go back to "Movies".

### Note

- If you select "Add to Wish List" or "Add to My Favorites" in title details screen, the title will be added to your "Wish List" or "My Favorites".
- For CinemaNow, if you want to redeem a gift code, select "Redeem Gift Code" in the checkout screen, then press [Enter] and enter the gift code.
- In most cases, rented movies or TV episodes are available for 24 hours from the playback starting time.

## Searching Movies / TV Episodes

From the search screen, you can search for movies/TV Episodes by entering search words.

- 1 Follow step 1 in "Renting or Purchasing Movies/TV Episodes" on page 39.**
- 2 Use [▲/▼] to select "Search All" or "Search", then press [Enter].**
  - Keypad screen will appear.
- 3 Use [▲/▼/◀/▶] to select characters, then press [Enter].**
  - When you enter a letter, titles that start with the letter will be displayed on the right side of the screen.
- 4 Use [▲/▼/◀/▶] to select a desired title from the search result on the right side of the screen, then press [Enter].**
  - Title details screen of the selected title will appear.

## Watching Rented or Purchased Movies / TV Episodes

- 1 Follow step 1 in "Renting or Purchasing Movies / TV Episodes" on page 39.**
- 2 Use [▲/▼/◀/▶] to select "My Videos" or "My Library", then press [Enter].**
  - List of rented or purchased movies/TV episodes will appear.
- 3 Use [▲/▼/◀/▶] to select a desired title, then press [Enter].**
- 4 Use [◀/▶] to select "Watch from Start" or "Play Now", then press [Enter].**
  - If you want to resume playback, select "Resume Play" and press [Enter].
  - To stop the playback, press [Stop ■].
  - To pause the playback, press [Pause II].
  - To go back to the opening screen, press [Top Menu] or [Setup].

### Note

- Depending on your network environment and speed, the playback may be paused or stopped. To improve playback condition, use high speed broadband Internet connection (For details, contact your Internet service provider.)

# FUNCTION SETUP

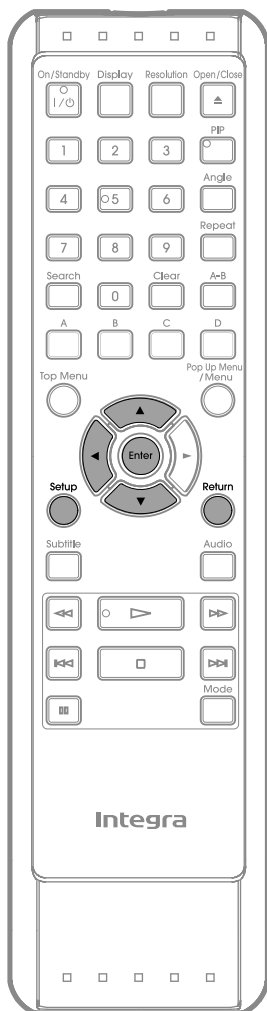

## Using the Setup Menu

In the setup menu you can change the setting for audio, video, language, etc. You cannot change the setting during playback.

Setting items displayed in gray indicates they are not available under the conditions at the time.

### Quick

“Quick” menu contains setting items extracted from “Custom” menu which may be used frequently.

**1** In stop mode, press [Setup].

**2** Use [▲/▼] to select , then press [Enter].

**3** Use [▲/▼] to select your desired setting items.



**4** Follow the procedure below depending on the setting items.

A) If “▶” does not appear on the right side of the setting items when you highlight the items:

Press [Enter] repeatedly to change options.

B) If “▶” appears on the right side of the setting items when you highlight the items:

1) Press [Enter].

2) Use [▲/▼] to select options, then press [Enter].

• Use [◀] or [Return] to go back to the previous screen.

**5** Press [Setup] to exit.



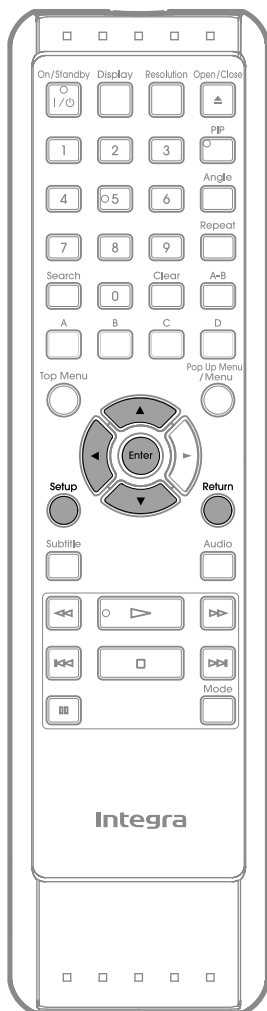

## Custom





"Custom" menu contains all the setting items.

- 1** In stop mode, press [Setup].

---

- 2** Use [▲/▼] to select , then press [Enter].

---

- 3** Use [▲/▼] to select your desired setting category, then press [Enter].
  -  : Language
  -  : Video
  -  : Audio
  -  : Parental
  -  : Others
    - For "Parental" menu, follow the procedure on page 49.

---

- 4** Use [▲/▼] to select your desired setting items.
  - The setting items which are not available with current situation of this unit will be displayed in gray and you cannot select them.

---

- 5** Follow the procedure below depending on the setting items.
  - A) If "▶" does not appear on the right side of the setting items when you highlight the items:  
Press [Enter] repeatedly to change options.
  - B) If "▶" appears on the right side of the setting items when you highlight the items:
    - 1) Press [Enter].
    - 2) Use [▲/▼] to select options, then press [Enter].
      - Use [◀] or [Return] to go back to the previous screen.

---

- 6** Press [Setup] to exit.

## ■ Language



- For how to select the setting items and options, refer to “Custom” on page 41.

Setting items	Options
<b>Audio</b> Sets the language for audio.	Original* / English / French / Spanish / German / Italian / Swedish / Dutch / Russian / Chinese / Japanese / Korean / Danish / Finnish / Norwegian / Icelandic / Hungarian / Romanian / Turkish / Greek / Irish / Portuguese / Polish / Czech / Slovak / Bulgarian / Other
<b>Subtitle</b> Sets the language for subtitle.	Off* / English / French / Spanish / German / Italian / Swedish / Dutch / Russian / Chinese / Japanese / Korean / Danish / Finnish / Norwegian / Icelandic / Hungarian / Romanian / Turkish / Greek / Irish / Portuguese / Polish / Czech / Slovak / Bulgarian / Other
<b>Disc Menu</b> Sets the language for disc menu or pop-up menu.	English* / French / Spanish / German / Italian / Swedish / Dutch / Russian / Chinese / Japanese / Korean / Danish / Finnish / Norwegian / Icelandic / Hungarian / Romanian / Turkish / Greek / Irish / Portuguese / Polish / Czech / Slovak / Bulgarian / Other
<b>Player Menu</b>  Sets the language for OSD (on-screen display).	Auto(XXXX)* <sup>1</sup> / English* / Français / Español

\*) Settings with (\*) are the default.

\*<sup>1</sup>) “Auto” activates the Get & Set Menu Language function. (Refer to page 51)

- “Auto” is available only when “HDMI CEC” is set to “On”.



- Inside the parentheses next to “Auto” will be the language which is currently selected by your TV.

- “Quick” menu consists of the setting menus frequently used, and they are accompanied with .
- If you select “Other”, enter the 4-digit-number code for the desired language (Refer to “LANGUAGE CODE” on page 61). Only the languages supported by the disc can be selected.

## ■ Video



- For how to select the setting items and options, refer to “Custom” on page 41.

Setting items	Options
<b>TV Aspect</b> Sets the picture size according to aspect ratio of the connected TV.	<b>16:9 Wide*:</b> Select this when a wide-screen TV is connected. Discs recorded in wide-screen format is played back over the entire TV screen. <b>4:3 Pan &amp; Scan:</b> Select this to play back the discs recorded in wide-screen format with 4:3 TV in the pan & scan mode (with the sides of the picture cut off). Discs which are not specified for pan & scan are played back in the letter box mode. <b>4:3 Letter Box:</b> Select this to play back the discs recorded in wide-screen format with 4:3 TV in the letter box mode. (with black strips at the top and bottom). <b>16:9 Squeeze:</b> When playing back 4:3 images, the picture is displayed in the center of the 16:9 screen with a 4:3 aspect ratio.
<b>HDMI Video Resolution</b>  Sets the HDMI video resolution.	<b>Auto*:</b> HDMI video resolution will be selected automatically depending on the connected HDMI device. 480p 720p 1080i 1080p <b>1080p24:</b> Gives a natural and high quality film reproduction of 24-frame film material. The connected TV has to be compatible with 1080p24 frame input.
<b>HDMI Deep Color</b> Sets whether to output the picture from HDMI OUT jack with Deep Color or not.	<b>Auto*:</b> The picture from HDMI OUT jack will be output with Deep Color to the connected TV which supports HDMI Deep Color. <b>Off:</b> The picture from HDMI OUT jack will be output without Deep Color.
<b>Component Output</b>  Sets the video resolution for component output.	480i* 480p 720p 1080i

Setting items	Options
<p><b>Progressive Mode</b> Sets the optimum progressive mode for the image material output from HDMI OUT jack and VIDEO OUTPUT (COMPONENT) jacks. Depending on the video material, image quality may get degraded due to the wrong Progressive Mode setting. In such case, change the setting.</p>	<p><b>Auto*:</b> The progressive mode will detect 24-frame film material (movies) and automatically select appropriate progressive mode.</p>
	<p><b>Video:</b> Suited for playing back video material discs (TV shows or animation).</p>
<p><b>Still Mode*<sup>1</sup></b> Adjusts picture resolution and quality in still mode.</p>	<p><b>Auto*:</b> Automatically selects the best resolution setting ("Frame" or "Field") based on the data characteristics of the pictures.</p>
	<p><b>Field:</b> Stabilizes the pictures, although the picture quality may become coarse due to the limited amount of data. Select "Field" when the pictures are still unstable even if "Auto" is selected.</p>
	<p><b>Frame:</b> Displays relatively motionless pictures in higher resolution. "Frame" improves the picture quality, although it may unstabilize the pictures due to alternate output of 2-field data.</p>

\*) Settings with (\*) are the default.

\*<sup>1</sup>) An individual picture on the TV screen is called "Frame", which consists of two separate images called "Field".

Some pictures may be blurred at the auto setting in "Still Mode" setting due to their data characteristics.

- "Quick" menu consists of the setting menus frequently used, and they are accompanied with .
- If the picture is not output properly to the TV because of "HDMI Video Resolution" or "Component Output" setting, press and hold **[Play ▶]** on the front panel for more than 5 seconds. Both settings will be reset to the default automatically.
- If an HDMI cable is connected, for video resolution for the component output, you can only select video resolution that currently output from HDMI OUT jack or "480i".
- If the video resolution for the component output and HDMI video resolution do not match, the video resolution for the component output will be switched to "480i". VIDEO OUTPUT (COMPONENT) jacks may not output any signals depending on the disc material.
- If you play back copy-protected DVD-video, 480p signal will be output from VIDEO OUTPUT (COMPONENT) jacks, when "Component Output" setting is set to "720p" or "1080i".
- Even if "HDMI Video Resolution" is set to "1080p24", for the BD that is not recorded by 1080p24 frame or for DVD, a video resolution supported by the disc and the display device will be output instead of 1080p24 frame.
- The setting items which are not available with current situation of this unit will be displayed in gray and you cannot select the items.
- If "HDMI Video Resolution" is set to "1080p" or "1080p24", you cannot set "Component Output".

## ■ Audio



- For how to select the setting items and options, refer to “Custom” on page 41.

Setting items	Options
<b>BD Audio Mode</b> For BD, selects whether to output the secondary and interactive audio with primary audio if it is available or only the primary audio. Refer to “Setting the BD Audio Mode” on page 36.	<b>HD Audio Output*:</b> Outputs only the primary audio. Set this mode in order to output Dolby Digital, Dolby Digital Plus, Dolby TrueHD, DTS or DTS-HD audio of BD through HDMI connection.
	<b>Mix Audio Output:</b> Outputs the secondary and interactive audio with primary audio if it is available.
<b>HDMI Audio Out</b>  Sets the audio format for the audio output from HDMI OUT and AUDIO OUTPUT (DIGITAL OPTICAL/ COAXIAL) jacks.	<b>HDMI Multi(Normal)*:</b> The multi-channel audio signals are output from HDMI OUT jack with bitstream or LPCM.
	<b>HDMI Multi(LPCM):</b> The multi-channel audio signals are output from HDMI OUT jack with LPCM. • Refer to pages 46-48 for setting options.
	<b>HDMI 2ch:</b> The audio signals are output from the HDMI OUT jack with a downmixed to 2ch LPCM.
	<b>Audio Mute:</b> Mutes the HDMI audio signal, and set the signal format from AUDIO OUTPUT (DIGITAL OPTICAL/ COAXIAL) jacks. • Refer to “Digital out setting” on page 46 for setting options.
<b>Down Sampling</b> Sets the digital audio output from AUDIO OUTPUT (DIGITAL OPTICAL/ COAXIAL) jacks when playing back BD or DVD recorded in LPCM.	<b>On:</b> LPCM signals are converted to 48 kHz for output. • Set to “On” when using digital connections to an AV receiver that is not compatible with sampling frequencies of 96 kHz.
	<b>Off*:</b> For BD and DVD recorded in LPCM without copyright protection, 2-channel audio signals up to 192 kHz are output as LPCM signals with no conversion.
<b>DRC</b> Sets whether to compress the range of sound volume (dynamic range control) when Dolby Digital, Dolby Digital Plus or Dolby TrueHD audio is played back.	<b>Auto*:</b> When the discs recorded in Dolby TrueHD format are in playback, this unit detects DRC setting of the disc and set “DRC” setting to “On” or “Off” automatically.
	<b>Off</b>
	<b>On</b>

\*) Settings with (\*) are the default.

- “Quick” menu consists of the setting menus frequently used, and they are accompanied with .
- Under following circumstances, “HDMI Multi(Normal)”, “HDMI Multi(LPCM)” and “HDMI 2ch” are not available.
  - HDMI cable is not connected to HDMI OUT jack.
  - Connected TV is off.
  - Connected TV is not compatible with audio output.

## ■ Digital out setting

When "Audio Mute" is selected in "HDMI Audio Out" setting, HDMI audio signal will be muted and the audio signals output from AUDIO OUTPUT (DIGITAL OPTICAL/COAXIAL) jacks change depending on "Digital Out" setting.

### Quick → HDMI Audio Out → Audio Mute → Digital Out

#### Bitstream\*:

When playing back discs recorded in Dolby Digital, Dolby Digital Plus, Dolby TrueHD, DTS® or DTS-HD®, the corresponding core stream (Dolby Digital or DTS®) are output.

#### LPCM:

LPCM signal will be output from AUDIO OUTPUT (DIGITAL OPTICAL/COAXIAL) jacks.

- This setting is not effective when the HDMI audio signal is output.

## ■ Speaker setting

This unit allows you to enjoy multi-channel surround sound such as 7.1-channel/5.1-channel surround.

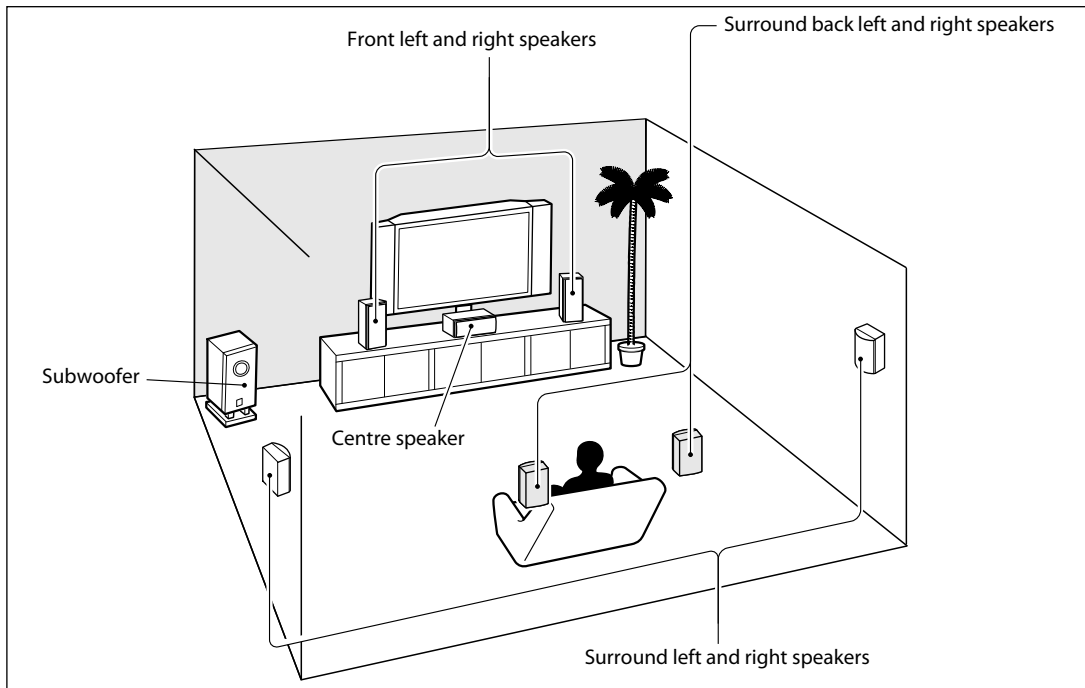

e.g.) basic layout with 7.1-channel surround system

To make the most of its feature, set up your speakers appropriately by referring to the following table.

Speaker setting options are available at the following locations;

<Speaker setting for the audio signal output from HDMI OUT jack>  
(Available when you have HDMI cable connected to HDMI OUT jack)

Quick → HDMI Audio Out → HDMI Multi(LPCM)

Custom → Audio → HDMI Audio Out → HDMI Multi(LPCM)

# FUNCTION SETUP

How to navigate through "HDMI Multi(LPCM)".

**1 Use [▲/▼] to select your desired menu item then press [Enter].**

**2 Use [▲/▼] to select your setting items.**

- Press [Return] to go back to the previous screen.

**3 Use [◀/▶] to select desired options. (Except for "Test Tone", "Default" and setting options in "Speaker Size" setting.)**

**For setting options in "Speaker Size" setting:**

**Press [Enter] to select desired options.**

**For "Test Tone":**

**Use [◀/▶] to select "Off", "Manual" or "Auto", then press [Enter].**

- The test tone will be output. If you select "Manual", use [▲/▼] to select desired speaker, then use [◀/▶] to adjust the volume. If you select "Auto", use [◀/▶] to adjust the volume of the speaker that outputs the test tone.
- If you want to stop the test tone, press [Return].

**For "Default":**

**Press [Enter] to reset to the default.**

**4 Press [Setup] to exit.**

Menu	Setting items	Options	Descriptions
<b>Speaker Size</b> Selects the desired speaker to set. Then change the setting appropriately by referring to the descriptions.	Front	Large*	Large: For the large speakers with strong low frequency reproduction capabilities. Small: For the small speakers which do not provide strong bass sound. You cannot change the setting of "Subwoofer". If connected device is not compatible with subwoofer, "Subwoofer" will be displayed in gray.
		Small	
	Center	Large*	
		Small	
	Subwoofer	On	
	Surround	Large*	
		Small	
Surround Back	Large*		
		Small	
Default			Select "Default", then press [Enter] to reset "Speaker Size" setting to the default.
<b>Channel Level</b> Tests or sets the volume for each speaker.	Test Tone: "Test Tone" is the test tone which can be output from the speakers so that you can adjust the volume for each speaker.	Off*	Select "Off" to deactivate "Test Tone".
		Manual	Select "Manual", then press [Enter] to manually set the volume for the desired speaker.
		Auto	Select "Auto", then press [Enter] to automatically output the test tone from each speaker.
	Front Lch	0 dB to -12 dB (0 dB*)	If you have selected "Manual" in "Test Tone", select the desired speaker to set and adjust the volume for the selected speaker.  If you select "Auto" in "Test Tone", test tone will automatically be output in order. Adjust the volume of the speaker that outputs the test tone.
	Center	0 dB to -12 dB (0 dB*)	
	Subwoofer	0 dB to -12 dB (0 dB*)	
	Front Rch	0 dB to -12 dB (0 dB*)	
	Surround Rch	0 dB to -12 dB (0 dB*)	
	Surround Back Rch	0 dB to -12 dB (0 dB*)	
	Surround Back Lch	0 dB to -12 dB (0 dB*)	
Surround Lch	0 dB to -12 dB (0 dB*)		
Default			

Menu	Setting items	Options	Descriptions
<b>Delay Time</b> This is a parameter for optimizing the timing at which the sound is output from the speakers according to their distance from the listening position.	Distance	Feet*	Set the desired measure system. This measure system will be used for "Delay Time" setting. Press <b>[Enter]</b> (or <b>[◀/▶]</b> ) to switch the settings.
		Meters	
	Front	0ft to 60ft (12ft*) (0m to 18m (3.6m*))	Select the distance from the listening position to the speaker to get the ideal delay time.
	Center	0ft to 60ft (12ft*) (0m to 18m (3.6m*))	
	Surround	0ft to 60ft (10ft*) (0m to 18m (3.0m*))	
	Surround Back	0ft to 60ft (10ft*) (0m to 18m (3.0m*))	
Default	Select "Default", then press <b>[Enter]</b> to reset "Delay Time" setting to the default.		

\*) Settings with (\*) are the default.

- For "Speaker Size" setting, the settings of each speaker size may be adjusted automatically corresponding to each setting. (e.g. If "Front" is set to "Small", you cannot set "Center", "Surround", and "Surround Back" to "Large".)
- For "Delay Time", the difference between the value of the "Front", "Surround" and "Surround Back" setting cannot exceed 15 ft (4.5m), and the difference between the value of the "Front" and "Center" setting cannot exceed 5 ft (1.5m).
- For "Delay Time", the value of the "Center", "Surround" and "Surround Back" setting cannot exceed the value of the "Front" setting.
- For "Delay Time", the setting of "Center", "Surround" and "Surround Back" will be changed automatically to the setting value of the "Front". (e.g. If the "Front" is set to 60ft (18m), the setting of "Center", "Surround" and "Surround Back" will be changed to 60ft (18m) as well.)



## ■ Parental

Ratings control allows you to set a limit, which prevents your children from viewing inappropriate materials. Playback will be stopped if the ratings exceed the levels you set, and it will require you to enter a password before playing back the disc.

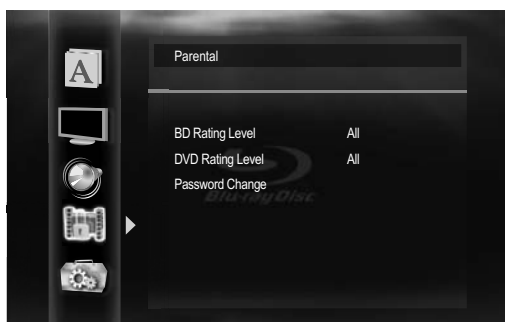

**1** Use [**▲** / **▼**] to select , then press [**Enter**].

**2** Use [the **Number buttons**] to enter your 4-digit password.

**For the first time use:** Use [the **Number buttons**] to enter any 4-digit number (except for 4737), then press [**Enter**]. That number will be used as the password from the second time. Record your password in case you forget it.

- If you forget the password, enter [**4**], [**7**], [**3**], [**7**]. The password will be cleared and rating level will be set to "All".
- While you input the password, press [**Clear**] to clear the number, then re-enter the password.

**3** Proceed to **A – C**

**A) BD Rating Level**

1) Use [**▲** / **▼**] to select "BD Rating Level", then press [**Enter**].

2) Use [**▲** / **▼**] to select your desired option, then press [**Enter**].

"All": To release the limitation.

"Age Setting": To set the age limitation.

- After selecting "Age Setting", use [the **Number buttons**] to enter the age from 0 – 254. (e.g. for age 15, press [**0**], [**1**], [**5**])

3) Press [**Setup**] to exit.

**B) DVD Rating Level**

1) Use [**▲** / **▼**] to select "DVD Rating Level", then press [**Enter**].

2) Use [**▲** / **▼**] to select your desired level, then press [**Enter**].

3) Press [**Setup**] to exit.

### **RATING EXPLANATIONS**

- **All** : Parental control is inactive; all discs can be played back.
- **8 [Adult]** : DVD software of any grades (adult / general / children) can be played back.
- **7 [NC-17]** : No one under 17 admitted.
- **6 [R]** : Restricted; under 17 requires accompanying parent or adult guardian.
- **5 [PGR]** : Parental guidance recommended.
- **4 [PG-13]** : Unsuitable for children under 13.
- **3 [PG]** : Parental guidance suggested.
- **2 [G]** : General audience.
- **1 [Kid Safe]** : Suitable for children.

**C) Password Change**

1) Use [**▲** / **▼**] to select "Password Change", then press [**Enter**].

2) Enter a new 4-digit password, then press [**Enter**].

3) Press [**Setup**] to exit.

### **Note**

- The resume information will be cleared if you change the parental level when the resume information is on.

## Others



- For how to select the setting items and options, refer to “Custom” on page 41.

Setting items	Options					
<b>Angle Icon</b>	On*: The angle icon appears on the TV screen when playing back the scene with various angle.					
	Off: The angle icon disappears on the TV screen.					
<b>Auto Power Off</b>	On*: If this unit is left with no activity for more than 25 minutes, this unit turns into the standby mode automatically.					
	Off: Sets off the auto power off.					
<b>Panel Display</b> Sets the brightness of the front panel display.	Auto*: Front panel display gets darker during playback.					
	Bright: Front panel display gets brighter.					
	Dimmer: Front panel display gets darker.					
<b>HDMI CEC</b> Sets whether to utilize HDMI CEC function.	On*					
	Off					
<b>Mode Select</b>  Selects the media to playback. Setting will be back to “Disc” when you turn the unit to the standby mode.	Disc*: Select this when you play back a disc.					
	SD Card: Select this when you play back an SD Memory Card.					
	Network: Select this when you use DLNA home media server or Netflix / CinemaNow / Blockbuster feature.					
<b>Network Connection</b>	Connection Test			Perform the network connection test. After you change the IP address or DNS setting, always perform this test.		
	Enable(Easy)*			If you select “Enable(Easy)”, connection test will automatically start.		
	Enable (Custom)	IP Address Setting	Auto(DHCP)*		Set the IP address. In most cases, you can connect to the Internet without making any changes to the default setting.	
			Manual	IP Address		
				Subnet Mask		
DNS Setting	DNS Setting	Auto(DHCP)*		Set the DNS setting. In most cases, you can connect to the Internet without making any changes to the default setting.		
		Manual	Primary DNS			
			Secondary DNS			

# FUNCTION SETUP

Setting items	Options				
<b>Network Connection</b>	Enable (Custom)	Proxy Setting	Do Not Use*	Set the proxy server. In most cases, you can connect to the Internet without using proxy server.	
			Use		Proxy Address
					Proxy Port
	Connection Speed	Auto*	Set the connection speed. In most cases, you can connect to the Internet without making any changes to the default setting.		
		10BASE Half			
		10BASE Full			
		100BASE Half			
		100BASE Full			
	BD-Live Setting	Allow*	You can restrict Internet access Limited Allow when BD-Live functions are used.		
		Limited Allow			
Prohibit					
	MAC Address		You can check the MAC address.		
Disable			Deactivate the network connection.		
Power On Control	Enable		Set to "Enable" to switch on/standby mode from the connected external device with a LAN cable.  When set to "Enable", the power consumption could reach a maximum of 5W.		
	Disable*				
Disclaimer			Displays the network service disclaimer.		
<b>Software Update</b> Allows you to update this unit's firmware. Refer to page 55.	Current Version : Indicates the current firmware version.				
	Disc Update : Allows you update this unit's firmware using a disc.				
	Network Update : You can update the firmware version by connecting this unit to the Internet.				

\*) Settings with (\*) are the default.

- HDMI CEC allows integrated system control over HDMI and is part of the HDMI standard. In addition to Integra/Onkyo AV components, it allows interoperability with CEC-compatible AV components and TVs made by other manufacturers.
- When "HDMI CEC" setting is set to "On", functions listed below will be available.

### Direct Change

When this unit is turned on, the TV also is turned on and the appropriate external input channel will be selected automatically. The appropriate external input channel can also be selected on your TV automatically when you press **[Play ▶]** when the unit's power is on.

### Standby

When you press and hold **[I / ⏻ On/Standby]** on the front panel for 2 seconds, it turns off the power of the TV first and then turns off the power of this unit also.

### System Information

#### Get & Set Menu Language

- The unit recognizes the OSD language set for the TV and automatically sets the same language as the player menu language (OSD menu language) for this unit.
- This feature is available only when "Auto(XXXX)" is selected in "Player Menu" in the setup menu. (Refer to "Player Menu" on page 42.)

### Note

- HDMI CEC is available only when the display device is connected by an HDMI cable, and when it supports HDMI CEC feature.

## Network Connection

Set up the network connection settings in order to use BD-Live, DLNA home media server, Netflix/CinemaNow/Blockbuster feature or network update function.

### Connection Test

After you enable a network connection or change the network settings, always perform the connection test to check if the connection is correctly made.

- 1 In stop mode, press [Setup].**
- 2 Use [▲/▼] to select , then press [Enter].**
- 3 Use [▲/▼] to select "Others", then press [Enter].**
- 4 Use [▲/▼] to select "Network Connection", then press [Enter].**
- 5 Use [▲/▼] to select "Connection Test", then press [Enter].**

Connection test will start automatically and the test result will appear right after the connection test finishes.

- "Testing...": The test is in progress.
- "Pass": Connection test is successfully completed.
- "Fail": Connection test failed. Check the connection settings.

Press [Enter] to go to the list of network status confirmation screen.

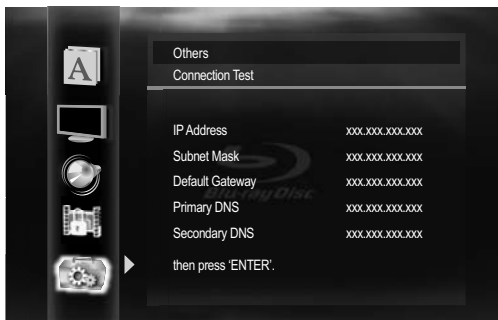

- 6 Press [Enter] to go back to the previous screen, or press [Setup] to exit.**

### Note

- If the connection test passes, you are ready to use BD-Live, DLNA home media server, Netflix/CinemaNow/Blockbuster feature or network update function, using the Internet without making any extra settings.
- If the connection test fails, you may need to change the MAC address settings on your router.
- "Connection Test" is not available when "Disable" is selected in "Network Connection".

## Enable(Easy)

Network settings are set to the following settings initially. (In most cases, you can connect to the Internet without making any changes to the default settings.)

- |                      |            |
|----------------------|------------|
| - IP Address Setting | Auto(DHCP) |
| - DNS Setting        | Auto(DHCP) |
| - Proxy Setting      | Do Not Use |
| - Connection Speed   | Auto       |
| - BD-Live Setting    | Allow      |

If you want to set the network settings back to the default settings as above (except "BD-Live Setting"), follow the procedure below.

- 1 Follow steps 1 to 4 in "Connection Test" on page 52.**
- 2 Use [▲/▼] to select "Enable(Easy)", then press [Enter].**
  - The unit will start the connection test automatically and the test result will appear right after the test finishes.
  - After the connection test finishes, press [Enter] to go to network status confirmation screen.
- 3 Press [Enter] to activate the network settings and set the network connection automatically. Press [Setup] to exit.**

### Note

- The setting of "BD-Live Setting" will not be set back to the default, even if you follow the procedure.

## Enable(Custom)

In following cases, select "Enable(Custom)" to set each setting as necessary.

- When connection test failed with the setting of "Enable(Easy)".
- When instructed by your Internet service provider to make specific settings in accordance with your network environment.

### • IP Address Setting / DNS Setting

- 1 Follow steps 1 to 4 in "Connection Test" on page 52.**
- 2 Use [▲/▼] to select "Enable(Custom)", then press [Enter].**
- 3 Use [▲/▼] to select "IP Address Setting", then press [Enter] repeatedly to select the desired setting.**

"Auto(DHCP)":	If your router has DHCP server function, select "Auto(DHCP)".
"Manual":	If your router does not have DHCP server function, select "Manual".

## If you select "Manual", follow the following instruction to set the IP address and DNS.

- 3-a) Use **[▲/▼]** to select "IP Address", "Subnet Mask" or "Default Gateway", then press **[Enter]**. IP address setting screen will appear. Enter IP address, subnet mask and default gateway with cursor buttons and number buttons.



- Enter the IP address number after checking the specifications of your router.
  - If the IP address number is unknown, check the IP address number of other devices. (e.g. PC connected via LAN cable) and assign a different number from those of other devices.
- 3-b) After you enter all correctly, press **[Enter]**.
- Confirmation message will appear. Select "Yes" to complete the settings.



- 3-c) Use **[▲/▼]** to select "Primary DNS" or "Secondary DNS", then press **[Enter]**. DNS setting screen will appear. Enter primary DNS and secondary DNS with cursor buttons and number buttons.

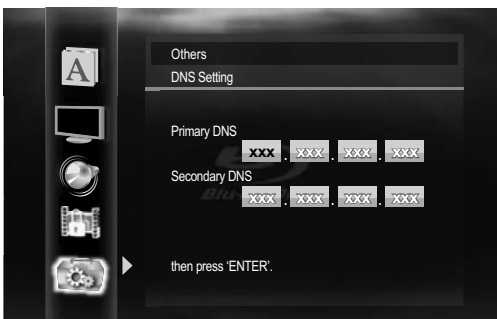

- Enter the numbers instructed by your Internet provider.
- If the number is unknown, check the number of other devices (e.g. PC connected via LAN cable) and assign the same number.

- 3-d) After you enter all correctly, press **[Enter]**.
- Confirmation message will appear. Select "Yes" to complete the settings.



## 4 Press [Return] to go back to the previous screen, or press [Setup] to exit.

### Note

- The range of input numbers is between 0 and 255.
- If you enter a number larger than 255, the number will automatically be 255.
- The manually entered number will be saved even if you change the setting to "Auto(DHCP)".
- When you enter a wrong number, press **[Clear]** to cancel. (the number will be back to "0".)
- If you want to enter 1 or 2 digit number in one cell, press **[▶]** to move on to the next cell.
- If the entered IP address or the default gateway or primary DNS number is same as the default setting, IP address setting will be set to "Auto(DHCP)". (The manually entered number will be saved.)
- When IP address setting is set to "Manual", the setting of DNS setting will automatically be "Manual" and when IP address setting is set to "Auto(DHCP)", you can set either "Auto(DHCP)" or "Manual" for DNS setting.

### • Proxy Setting

- 1 Follow steps 1 to 4 in "Connection Test" on page 52.
- 2 Use **[▲/▼]** to select "Enable(Custom)", then press **[Enter]**.
- 3 Use **[▲/▼]** to select "Proxy Setting", then press **[Enter]** repeatedly to select the desired setting.
  - For default settings, select "Do Not Use".
  - If you need to change the proxy setting as instructed by your Internet service provider to set the designated proxy address and port, select "Use".

### If you select "Use", follow the following instructions to set the proxy address and proxy port.

- 3-a) Use **[▲/▼]** to select “Proxy Address”, then press **[Enter]**. Proxy address setting screen will appear. Enter proxy address.
- The keyboard screen will appear.



- [▲/▼/◀/▶]**: Move the highlight.  
**[the Number buttons]**: Enter number.  
**[Enter]**: Enter the highlighted number /word.  
**[A]**: Clear the entered number or word.  
**[B]**: Clear all the entered numbers or words.  
**[C]**: Switch between abc ? ABC ? @!?  
**[D]**: Set the entered number or word.

- 3-b) After you enter proxy address correctly, press **[D]**.
- Confirmation message will appear. Select “Yes” to complete the settings.



- 3-c) Use **[▲/▼]** to select “Proxy Port”, then press **[Enter]**. Proxy port setting screen will appear. Enter proxy port number with number buttons.



- 3-d) After you enter proxy port correctly, press **[Enter]**.

- 4 Press [Return] to go back to the previous screen, or press [Setup] to exit.**

### Note

- The range of input numbers for the port number is between 0 and 65535. (If you enter a number larger than 65535, it will be regarded as 65535.)
- For proxy port, the selected ports may be blocked and not be able to use depending on your network environment.

## • Connection Speed

You can set connection speed as your preference. (The default setting is “Auto”).

- 1 Follow steps 1 to 4 in “Connection Test” on page 52.**
- 2 Use [▲/▼] to select “Enable(Custom)”, then press [Enter].**
- 3 Use [▲/▼] to select “Connection Speed”, then press [Enter].**
- 4 Use [▲/▼] to select the desired setting, then press [Enter].**

### “Auto”:

Set the appropriate connection speed automatically, in accordance with your network environment.

### “10BASE Half”:

Set the connection speed to “10BASE Half”.

### “10BASE Full”:

Set the connection speed to “10BASE Full”.

### “100BASE Half”:

Set the connection speed to “100BASE Half”.

### “100BASE Full”:

Set the connection speed to “100BASE Full”.

- 5 Press [Return] to go back to the previous screen, or press [Setup] to exit.**

### Note

- Choose a connection speed in accordance with your network environment.
- The network connection may be disabled depending on the device, when the settings are changed.

## • BD-Live Setting

You can limit Internet access for BD-Live discs. (The default setting is “Allow”).

- 1 Follow steps 1 to 4 in “Connection Test” on page 52.**
- 2 Use [▲/▼] to select “Enable(Custom)”, then press [Enter].**
- 3 Use [▲/▼] to select “BD-Live Setting”, then press [Enter].**
- 4 Use [▲/▼] to select the desired setting, then press [Enter].**

### “Allow”:

Internet access is permitted for all BD-Live contents.

### “Limited Allow”:

Internet access is permitted only for BD-Live contents which have content owner certificates. Internet access without the certificates is prohibited.

### “Prohibit”:

Internet access is prohibited for all BD-Live contents.

- 5 Press [Return] to go back to the previous screen, or press [Setup] to exit.**

## Disable

Deactivate all the network connection and settings.

- 1 Follow steps 1 to 4 in “Connection Test” on page 52.
- 2 Use [▲/▼] to select “Disable”, then press [Enter].
- 3 Press [Return] to go back to the previous screen, or press [Setup] to exit.

### Note

- The network connection can be reactivated by setting the network connection to “Enable(Easy)” or “Enable(Custom)”.

## Software Update

### Current Version

You can confirm the current software version.

- 1 Follow steps 1 to 3 in “Connection Test” on page 52.
- 2 Use [▲/▼] to select “Software Update”, then press [Enter].
- 3 Use [▲/▼] to select “Current Version”, then press [Enter].



- 4 Press [Enter] or [Return] to exit.

### Note

- Please visit [www.integrahometheater.com](http://www.integrahometheater.com) to download the latest firmware version.

## Disc Update

You can update the software by using disc.

- 1 Follow steps 1 to 3 in “Connection Test” on page 52.
- 2 Use [▲/▼] to select “Software Update”, then press [Enter].
- 3 Use [▲/▼] to select “Disc Update”, then press [Enter].
- 4 Use [▲/▼] to select “Yes”, then press [Enter].
- 5 Disc tray will open automatically.
  - Insert the disc for software update and then press [Open / Close ▲].

- 6 After completing loading disc, confirmation message will appear. Select “Yes” and press [Enter] to start updating.

- It may take a while to complete the updating. (Please wait until “100%” appears on the front panel display.)

- 7 After the disc update finishes, this unit will restart and eject the disc.

### Note

- Please do not unplug the AC power cord while executing the “Disc Update”.
- All settings will remain the same even if you update the firmware version.
- The version of Netflix will also be updated if newer version of Netflix is available when updating the firmware.

## Network Update

You can update the software by connecting the unit to the Internet.

- 1 Follow steps 1 to 3 in “Connection Test” on page 52.

- 2 Use [▲/▼] to select “Software Update”, then press [Enter].

- 3 Use [▲/▼] to select “Network Update”, then press [Enter].

- 4 Use [▲/▼] to select “Yes”, then press [Enter].

- This unit will then start checking for the latest firmware version.

- 5 Confirmation message will appear. Use [▲/▼] to select “Yes”, then press [Enter].

- The unit will start downloading the latest firmware version.

- 6 When the download completes, confirmation message will appear. Press [Enter].

- The unit will start updating the firmware version.
- It may take a while to complete the updating. (Please wait until “100%” appears on the front panel display.)

- 7 After updating finishes, this unit will restart and open the disc tray automatically.

### Note

- Please do not unplug the AC power cord or LAN cable while executing the “Network Update”.
- All settings will remain the same even if you update the software version.
- The disc tray will open automatically after updating finishes. This is not a malfunction.
- The version of Netflix will also be updated if newer version of Netflix is available when updating the firmware.

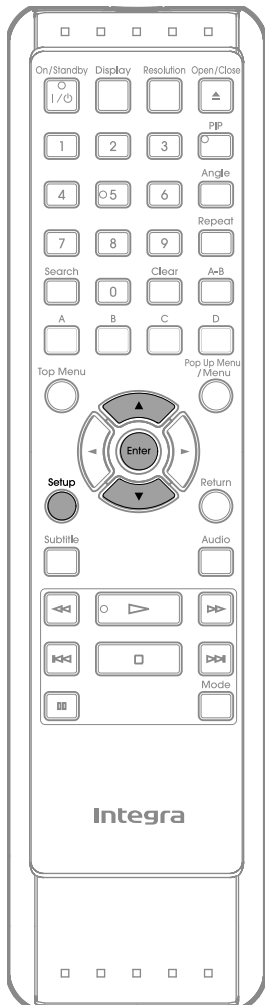

## Initialize

Initialize the setting, SD Memory Card, network setting or deactivate Netflix.

**1** In stop mode, press [Setup].

**2** Use [▲/▼] to select , then press [Enter].

**3** Use [▲/▼] to select a desired option, then press [Enter].

**“Setup”**: Resets the setup menu to the default. The setting for “Parental”, “Network Connection” and “Mode Select” will not be reset.

**“Format SD Card” (Available only when an SD Memory Card is inserted.)**:

Initializes the SD Memory Card.

**“Erase Saved BD-ROM Data (Player)”**:

Clears the data saved for the BD-ROM contents, such as BD-ROM game scores, from this player.

**“Erase Saved BD-ROM Data (SD Card)”**

**(Available only when an SD Memory Card is inserted.)**:

Clears the supplemental data for the BD-ROM playback, such as subtitle data, from the SD Memory Card.

**“Network Settings”**:

Resets the Network Settings menu to the default.

**“Netflix Deactivate”**:

Deactivate the connection to Netflix.

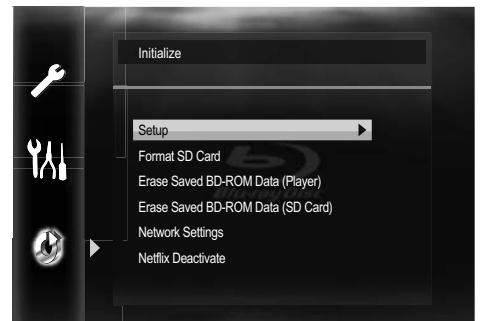

**4** Confirmation message will appear. Use [▲/▼] to select “Yes”, then press [Enter].

**5** Press [Setup] to exit.

### Caution

- Do not remove the SD Memory Card while executing the “Format SD Card” or the “Erase Saved BD-ROM Data (SD Card)”. It damages the card.



# TROUBLESHOOTING

If the unit does not perform properly when operated as instructed in this manual, check the unit, consulting the following checklist.

Problem	Solution
No power.	<ul style="list-style-type: none"> <li>- Check if the AC cord is properly connected.</li> <li>- Unplug the AC cord once, and wait for 5-10 seconds and then plug it in again.</li> </ul>
No sound or picture.	<ul style="list-style-type: none"> <li>- Check if the connected TV or AV receiver is turned on.</li> <li>- Check if the connections are made securely and correctly.</li> <li>- Check whether the connected TV, AV receiver or other device supports HDCP. (This unit will not output a video signal unless the other device supports HDCP.)</li> <li>- Check whether the output format of this unit (HDMI FORMAT) matches the supported input format of other connected device.</li> <li>- When this unit is connected to the DVI jack on your TV or AV receiver, you cannot hear any sound from the HDMI OUT jack if your TV or AV receiver only supports DVI.</li> <li>- When the display device does not support the desired video resolution, press and hold <b>[Play ▶]</b> on the front panel for more than 5 seconds. Both settings will be reset to the default automatically.</li> </ul>
No audio/video signal on the display device via HDMI cable.	<ul style="list-style-type: none"> <li>- If the unit is connected the unauthorized display device with an HDMI cable, the audio/video signal may not be output.</li> <li>- Perform an HDMI cable hotplug, wherein you disconnect the HDMI cable from the TV, AV receiver and this unit and then reconnect it to both the devices while they are powered on.</li> <li>- Ensure that your HDMI cable is certified.</li> </ul>
Distorted picture.	<ul style="list-style-type: none"> <li>- Sometimes a small amount of picture distortion may appear. This is not a malfunction.</li> <li>- Connect this unit directly to the TV. If the RCA audio/video cables are connected to a VCR, pictures may be distorted due to the copy right protection system.</li> </ul>
Completely distorted picture or black/white picture with BD/DVD.	<ul style="list-style-type: none"> <li>- Make sure the disc is compatible with this unit.</li> </ul>
No sound or distorted sound.	<ul style="list-style-type: none"> <li>- Adjust the volume.</li> <li>- Check that the speakers are connected correctly.</li> <li>- Check the HDMI connections.</li> <li>- Check the settings in "Audio" menu.</li> </ul>
Picture freezes momentarily during playback.	<ul style="list-style-type: none"> <li>- Check the disc for fingerprints/scratches and clean with a soft cloth wiping from center to edge.</li> <li>- Clean the disc.</li> </ul>
Disc cannot be played back.	<ul style="list-style-type: none"> <li>- Clean the disc.</li> <li>- Ensure the disc label is facing up.</li> <li>- Check if the disc is defective by trying another disc.</li> <li>- Cancel the ratings control or change the control level.</li> <li>- Insert a correct disc that can be played back on this unit.</li> </ul>
SD Memory Card cannot be read.	<ul style="list-style-type: none"> <li>- The format of the card does not match to this unit or the card is not compatible. (Refer to page 21.)</li> </ul>
No return to start-up screen when disc is removed.	<ul style="list-style-type: none"> <li>- Reset this unit by turning it off, then on again.</li> </ul>
The unit does not respond to the remote control.	<ul style="list-style-type: none"> <li>- Aim the remote control directly at infrared sensor window on the front panel.</li> <li>- Reduce the distance to infrared sensor window.</li> <li>- Replace the batteries in the remote control.</li> <li>- Re-insert the batteries with their polarities (+/- signs) as indicated.</li> <li>- Check if a strong light source is not interfering with this unit's infrared sensor. Make sure that the unit is not subjected to direct sunshine or inverter-type fluorescent lights. Relocate if necessary.</li> <li>- If the BD player is installed in a cabinet with colored glass doors, the remote control may not work reliably when the doors are closed. Open the doors, or use a cabinet without colored glass.</li> </ul>
Buttons do not work or the unit stops responding.	<ul style="list-style-type: none"> <li>- To completely reset the unit, unplug the AC cord from the AC outlet for 5-10 seconds.</li> </ul>
The unit does not respond to some operating commands during playback.	<ul style="list-style-type: none"> <li>- Operations may not be permitted by the disc. Refer to the instructions of the disc.</li> </ul>
The unit cannot read BD/DVD/CD.	<ul style="list-style-type: none"> <li>- Condensation? (Let sit 1 or 2 hours)</li> <li>- You are attempting to playback a disc other than one with one of the marks on page 21.</li> <li>- Wipe the dirt off the disc or replace the disc.</li> </ul>
Angle does not switch.	<ul style="list-style-type: none"> <li>- The angle cannot be switched for BD/DVD which do not contain multiple angles. In some cases multiple angles are only recorded for specific scenes.</li> </ul>

# TROUBLESHOOTING

Problem	Solution
Playback does not start when the title is selected.	- Check the settings in "Parental" menu.
The password for rating level has been forgotten.	- Enter the default password "4737", then your forgotten password will be cleared.
Cannot connect the network.	- Check if the LAN cable connection is properly made. - Turn on the modem or broadband router. - Check the network setting. - Check if the broadband router and /or modem is correctly connected. - Check the "BD-Live Setting".
Cannot connect to the network while my PC is connected to the network.	- Check the content of your Internet service contract to see if your Internet service provider prevents multiple terminals connecting at the same time.
The capacity of the SD card decreased.	- Data may be written to the SD card when a BD-video that supports the virtual package is used and an SD card is in the slot.
Cannot use the BD-Live function or download of data does not perform properly.	- Insert an SD card with enough capacity (1GB or more). - Check if an SD card is correctly inserted. - Make sure the write-protect switch on the SD card is not enabled.
Cannot play back BD-video (BD-ROM Profile 2.0).	- Insert an SD card(1GB or more) which is formatted on this unit. Some discs with BD-Live function require memory when playing back the content. - Do not remove the card during playback. - Make sure the write-protect switch on the SD card is not enabled.
Folder or files stored on DLNA home media server are not displayed in the file list or cannot be played back.	- Check the setting on your home media server. (Refer to the owner's manual of the home media server.) - Check the network connection and settings.
Cannot use Netflix feature.	- Netflix is available only in the United States. - Check if the network connection is properly made. - Visit <a href="http://netflix.com/Integra">netflix.com/Integra</a> on your PC and become a Netflix member.
Cannot add movies or TV episodes to the instant Queue.	- Visit <a href="http://netflix.com">netflix.com</a> on your PC. - Adding movies or TV episodes on this unit is not available.
Even though the speed of the Internet connection improves during playback, the picture quality of Netflix streaming movie does not improve.	- The picture quality does not change during playback. - The picture quality differs depending on the speed of Internet connection at the time of loading.
The picture quality of streaming movie (Netflix, CinemaNow or Blockbuster) is poor.	- Check the speed of your Internet connection.
Streaming movie (Netflix, CinemaNow or Blockbuster) often stops or start buffering during playback.	- Contact your Internet service provider. (You may need to improve the broadband speed.)
Cannot use CinemaNow / Blockbuster feature.	- Check if the network connection is properly made. - Visit <a href="http://www.cinemanow.com/Login">www.cinemanow.com/Login</a> (CinemaNow) or <a href="http://www.blockbuster.com/auth/login">www.blockbuster.com/auth/login</a> (Blockbuster) on your PC and create an account.
The playback of BD-video or download of data does not perform properly.	- Check if an SD card is correctly inserted. Do not remove the card during playback as some BD-videos require an SD card during playback.
"HDCP NOK" appears on the front panel display.	"HDCP NOK" appears under the following conditions: - When the connected device does not support HDCP. - When the connected device is recognized as an HDCP incompatible by HDMI SRM. - When the connected device supports HDCP but cannot be recognized as an HDCP compatible for some reason.

The BD player contains a microcomputer for signal processing and control functions. In very rare situations, severe interference, noise from an external source, or static electricity may cause it to lockup. In the unlikely event that this happens, unplug the power cord from the wall outlet, wait at least 5 seconds, and then plug it back in again.

## Note

- Some functions are not available in specific modes, but this is not a malfunction. Read the description in this manual for details on correct operations.
- Some functions are prohibited on some discs.

## **Analog Audio**

An electrical signal that directly represents sound. Compare this to digital audio which can be an electrical signal, but is an indirect representation of sound. See also "Digital Audio".

## **Aspect Ratio**

The width of a TV screen relative to its height. Conventional TVs are 4:3 (in other words, the TV screen is almost square); widescreen models are 16:9 (the TV screen is almost twice as wide as it is high).

## **AVCHD**

AVCHD is a new format for high definition video camcorders which can record and play high-resolution HD images.

## **BD-Java**

With some BDs which support Java applications, you can enjoy the interactive functions such as games or interactive menus.

## **BD-Live**

BD-Live is a BD-video (BD-ROM version 2 Profile 2.0/Profile 1.1) which contains new functions (e.g. Internet connection), in addition to the BONUSVIEW function.

## **Blockbuster**

Blockbuster is online service which you can rental or purchase movies and TV episodes streamed over the Internet.

## **Blu-ray Disc (BD)**

Blu-ray Disc is a next generation optical video disc which is capable of storing much more data than a conventional DVD. The large capacity makes it possible to benefit from the features such as high-definition videos, multi-channel surround sounds, interactive menus and so on.

## **Chapter**

Just as a book is split up into several chapters, a title on a BD-video or DVD-video is usually divided into chapters. See also "Title".

## **CinemaNow**

CinemaNow is online service which you can rental or purchase movies and TV episodes streamed over the Internet.

## **Component Video Output**

Each signal of luminance (Y) and component (P<sub>B</sub>/C<sub>B</sub>, P<sub>R</sub>/C<sub>R</sub>) is independent to output so that you can experience picture color as it is.

Also, due to compatibility with progressive video (525p/480p), you can experience higher-density picture than that in interlace (525i/480i).

## **Deep Color**

This technology allows expression of more number of colors than the conventional 8 bits and can reproduce colors close to natural ones without color streak.

## **Digital Audio**

An indirect representation of sound by numbers. During recording, the sound is measured at discrete intervals (44,100 times a second for CD audio) by an analog-to-digital converter, generating a stream of numbers. On playback, a digital-to-analog converter generates an analog signal based on these numbers. See also "Sampling Frequency" and "Analog Audio".

## **DLNA (Digital Living Network Alliance)**

DLNA is a cross-industry organization of consumer electronics that formulates DLNA Interoperability Guidelines for sharing digital contents within a home network.

## **DNS Server**

A server which translates Internet domain names into IP addresses.

## **Dolby Digital**

The system to compress digital sound developed by Dolby Laboratories. It offers you sound of stereo (2ch) or multi-channel audio.

## **Dolby Digital Plus**

Dolby Digital Plus is the next generation digital audio compression technology developed as an extension to Dolby Digital. Blu-ray Disc supports 7.1 multi-channel surround sound output.

## **Dolby TrueHD**

Dolby TrueHD is a lossless coding technology developed for next generation optical discs. Blu-ray Disc supports 7.1 multi-channel surround sound output.

## **DTS® (Digital Theater System)**

DTS® is a multi-channel surround sound system. You can enjoy movie dynamic and realistic sound like movie theater. DTS surround sound technologies were developed by DTS, Inc.

## **DTS-HD®**

DTS-HD® is a lossless coding technology developed as an extension of the original DTS Coherent Acoustics format. Blu-ray Disc supports 7.1 multi-channel surround sound output.

## **Gateway**

IP address of the electronic devices (such as router) which provide Internet access.

## **HDMI (High-Definition Multimedia Interface)**

A digital interface between audio and video source. It can transmit component video, audio, and control signal with one cable connection.

## **Hub**

A device used for connecting multiple device to the network.

## **IP Address**

A set of numbers which are assigned to devices participating in a computer network.

## **JPEG (Joint Photographic Experts Group)**

JPEG is a method of compressing still picture files. You can copy JPEG files on BD-RE/-R, DVD-RW/-R, CD-RW/-R, SD Memory Card or DLNA home server from a computer and play back the files on this unit.

## **LAN (Local Area Network)**

A group of computer networks covering a small area like a company, school or home.

## **Local Storage**

A storage area of sub contents for playing virtual packages on BD-video.

## **MP3 (MPEG audio layer 3)**

MP3 is a method of compressing files. You can copy MP3 files on BD-RE/-R, DVD-RW/-R, CD-RW/-R, SD Memory Card or DLNA home server from the computer and play back the files on this unit.

## **MPEG**

This is an abbreviation of Moving Picture Experts Group, which is an international standard of the moving picture audio compression method. Images of BD and DVD are recorded using this method.

## **MPEG2-TS/TTS**

This is adopted in digital broadcasting.

TTS (Timestamped TS) is a format of TS packet with Timestamp information. TS is an abbreviation of Transport Stream.

## **MPEG2-PS**

This is used for DVD and HDD recording format. PS is an abbreviation of Program Stream.

## **Netflix**

Netflix is online movie rental service, offering online streaming to customers in the United States.

## **PCM (Pulse Code Modulation)**

The most common system of encoding digital audio, found on CD and DAT. Excellent quality, but requires a lot of data compared to formats such as Dolby Digital and MPEG audio. For compatibility with digital audio recorders (CD, MD and DAT) and AV receivers with digital inputs, this unit can convert Dolby Digital and MPEG audio to PCM. See also "Digital Audio".

## **Proxy Server**

Proxy server is a server which acts as an intermediary between a workstation user and the Internet to ensure security.

## **Region Code**

Regions associate discs and players with particular areas of the world. This unit will only play back discs that have compatible region codes. You can find the region code of your unit by looking on the rear panel. Some discs are compatible with more than one region (or all regions).

## **Router**

A networking device which distinguishes the IP address assigned to each device and routing and forwarding information in the computer network.

## **Sampling Frequency**

The rate which sound is measured by a specified interval to turn into digital audio data. The numbers of sampling in one second defines as sampling frequency. The higher the rate, the better the sound quality.

## **Subnet Mask**

A mask which is used to determine what subnet an IP address belongs to.

## **Title**

A collection of chapters on BD-video or DVD-video. See also "Chapter".

## **Track**

Audio CD use tracks to divide up the content of a disc. The BD-video or DVD-video equivalent is called a chapter. See also "Chapter".

## **Virtual Package**

The function which copies data to other media (local storage) from the Internet and plays the secondary video, secondary audio and the subtitles at the same time. The method of the playback varies depending on discs.

## **Windows Media™ Audio**

Windows Media™ Audio is the audio compressing technology developed by Microsoft. You can copy Windows Media™ Audio files on BD-RE/-R, DVD-RW/-R, CD-RW/-R, SD Memory Card or DLNA home server from a computer and play them back on this unit.

## **x.v.Color**

"x.v.Color" is a promotion name given to the products that have the capability to realize a wide color space based on the xvYCC specifications and is a trademark of Sony Corporation.

# LANGUAGE CODE

Language	Code	Language	Code	Language	Code	Language	Code
<b>A-B</b>		French [FRE]	5264	Macedonian	5957	Siswat	6565
Abkhazian	4748	Frisian	5271	Malagasy	5953	Slovak [SLO]	6557
Afar	4747	Galician	5358	Malay	5965	Slovenian	6558
Afrikaans	4752	Georgian	5747	Malayalam	5958	Somali	6561
Albanian	6563	German [GER]	5051	Maltese	5966	Spanish [SPA]	5165
Amharic	4759	Greek [GRE]	5158	Maori	5955	Sundanese	6567
Arabic	4764	Greenlandic	5758	Marathi	5964	Swahili	6569
Armenian	5471	Guarani	5360	Moldavian	5961	Swedish [SWE]	6568
Assamese	4765	Gujarati	5367	Mongolian	5960	<b>T</b>	
Aymara	4771	Hausa	5447	Nauru	6047	Tagalog	6658
Azerbaijani	4772	Hebrew	5569	Nepali	6051	Tajik	6653
Bashkir	4847	Hindi	5455	Norwegian [NOR]	6061	Tamil	6647
Basque	5167	Hungarian [HUN]	5467	<b>O-R</b>		Tatar	6666
Bengali;Bangla	4860	<b>I-K</b>		Occitan	6149	Telugu	6651
Bhutani	5072	Icelandic [ICE]	5565	Oriya	6164	Thai	6654
Bihari	4854	Indonesian	5560	Oromo(Afan)	6159	Tibetan	4861
Bislama	4855	Interlingua	5547	Panjabi	6247	Tigrinya	6655
Breton	4864	Interlingue	5551	Pashto;Pushto	6265	Tonga	6661
Bulgarian [BUL]	4853	Inupiak	5557	Persian	5247	Tsonga	6665
Burmese	5971	Irish [IRI]	5347	Polish [POL]	6258	Turkish [TUR]	6664
Byelorussian	4851	Italian [ITA]	5566	Portuguese [POR]	6266	Turkmen	6657
<b>C-E</b>		Japanese [JPN]	5647	Quechua	6367	Twi	6669
Cambodian	5759	Javanese	5669	Rhaeto-Romance	6459	<b>U-Z</b>	
Catalan	4947	Kannada	5760	Romanian [RUM]	6461	Ukrainian	6757
Chinese [CHI]	7254	Kashmiri	5765	Russian [RUS]	6467	Urdu	6764
Corsican	4961	Kazakh	5757	<b>S</b>		Uzbek	6772
Croatian	5464	Kinyarwanda	6469	Samoaan	6559	Vietnamese	6855
Czech [CZE]	4965	Kirghiz	5771	Sangho	6553	Volapuk	6861
Danish [DAN]	5047	Kirundi	6460	Sanskrit	6547	Welsh	4971
Dutch [DUT]	6058	Korean [KOR]	5761	Scots Gaelic	5350	Wolof	6961
English [ENG]	5160	Kurdish	5767	Serbian	6564	Xhosa	7054
Esperanto	5161	<b>L-N</b>		Serbo-Croatian	6554	Yiddish	5655
Estonian	5166	Laothian	5861	Sesotho	6566	Yoruba	7161
<b>F-H</b>		Latin	5847	Setswana	6660	Zulu	7267
Faroese	5261	Latvian;Lettish	5868	Shona	6560		
Fiji	5256	Lingala	5860	Sindhi	6550		
Finnish [FIN]	5255	Lithuanian	5866	Singhalese	6555		

## Note

- If you choose a language that has a 3-letter-language code (written in bracket), the code will be displayed every time you change the audio or subtitle language setting on page 35. If you choose any other languages, '---' will be displayed instead.

# SPECIFICATIONS

## General

Signal system	NTSC color
Power requirements	120V AC, 60Hz
Power consumption	20W (standby: 0.6W)
Dimensions (width x height x depth)	17 <sup>-1/8</sup> x 4 <sup>-1/4</sup> x 12 <sup>-3/16</sup> inches (435 x 108 x 309mm)
Weight	10.9 lbs ( 4.9kg )
Operating temperature	41°F (5°C) to 104°F (40°C)
Operating humidity	Less than 80% (no condensation)

## Audio

BD Linear Audio	4 Hz–88 kHz (192 kHz)
DVD Linear Audio	4 Hz–44 kHz (96 kHz), 4 Hz–22 kHz (48 kHz)
Audio CD	4 Hz–20 kHz (44.1 kHz)
Signal to Noise Ratio	100 dB
Audio Dynamic Range	98 dB
THD (Total Harmonic Distortion)	0.005% (1 kHz)

## Terminals

Rear	<b>Audio output (Analog)</b>	
	RCA jack x 2	L/R: 2Vrms (output impedance: more than 1kΩ)
	<b>Video output</b>	
	RCA jack x 1	1Vp-p (75Ω)
	<b>Component video output</b>	
	RCA jack x 3	Y: 1Vp-p (75Ω)    PB: 700mVp-p (75Ω)    PR: 700mVp-p (75Ω)
	<b>Audio output (Digital)</b>	
	RCA jack x 1	500mVp-p (75Ω)
	Optical jack x 1	Digital connector
	<b>HDMI output</b>	
	HDMI jack x 1	Video: 480p, 720p, 1080i, 1080p, 1080p24 / Audio
	<b>ETHERNET terminal</b>	10BASE-T / 100BASE-TX

## Note

- The specifications and design of this product are subject to change without notice.

## Network Service Disclaimer

Content and services made available through this product are transmitted by third parties by means of networks and transmission facilities over which Company has no control and third party services may be terminated or interrupted at any time, and Company makes no representation or warranty that any content or service will remain available for any period of time. Without limiting the generality of this disclaimer, Company expressly disclaims any responsibility for any interruption or suspension of any content or service made available through this product. Company is not responsible for customer service related to the content and services. Any question or request for service relating to the content or services should be made directly to the respective content and service providers.

THIRD PARTY CONTENT AND SERVICES MADE AVAILABLE THROUGH THIS PRODUCT ARE PROVIDED "AS IS." COMPANY DOES NOT WARRANT CONTENT OR SERVICES SO PROVIDED, FOR ANY PURPOSE WHATSOEVER. COMPANY EXPRESSLY DISCLAIMS ANY WARRANTIES, EXPRESS OR IMPLIED INCLUDING WITHOUT LIMITATION, WARRANTIES OF MERCHANTABILITY OR FITNESS FOR A PARTICULAR PURPOSE, ACCURACY, VALIDITY, TIMELINESS, LEGALITY, SUITABILITY, OR QUALITY OF ANY CONTENT OR SERVICE MADE AVAILABLE THROUGH THIS PRODUCT.

IN NO EVENT SHALL COMPANY BE LIABLE FOR, ANY DAMAGES, WHETHER ARISING IN CONTRACT OR TORT, INCLUDING WITHOUT LIMITATION, ANY DIRECT, INDIRECT, INCIDENTAL, SPECIAL OR CONSEQUENTIAL DAMAGES, LOST PROFITS, ATTORNEY FEES, EXPENSES, OR ANY OTHER DAMAGES ARISING OUT OF, OR IN CONNECTION WITH, ANY CONTENT (OR ANY INFORMATION CONTAINED THEREIN) OR SERVICE PROVIDED TO THE USER OR ANY THIRD PARTY, EVEN IF ADVISED OF THE POSSIBILITY OF SUCH DAMAGES.

All content and services accessible through this product belong to third parties and are protected by copyright, patent, trademark and/or other intellectual property rights. Such content and services are provided solely for the User's personal noncommercial use. User may not use any content or services in a manner that has not been authorized by the content owner or service provider. Without limiting the foregoing, unless expressly authorized by the applicable content owner or service provider, you may not modify, copy, republish, upload, post, transmit, translate, sell, create derivative works, exploit, or distribute in any manner or medium any content or services made available through this product.

Integra Division of  
**ONKYO U.S.A. CORPORATION**  
18 park Way, Upper Saddle River, N.J. 07458, U.S.A.  
Tel: 800-225-1946, 201-818-9200 Fax: 201-785-2650 <http://www.integrahometheater.com>

Integra Division of  
**ONKYO CORPORATION**  
Sales & Product Planning Div.: 2-1, Nisshin-cho, Neyagawa-shi, OSAKA 572-8540, JAPAN  
Tel: 072-831-8023 Fax: 072-831-8163

SN 29400492  
(C) Copyright 2010 ONKYO CORPORATION Japan. All rights reserved.



Printed in China  
E5SF1UD/1VMN29753 ★★★★★



\* 1 V M N 2 9 7 5 3 \*