

**SAMSUNG**

Samsung GALAXY **Tab**<sub>10.1</sub> **GT-P7510**  
user manual



# Using this manual

Congratulations on your purchase of the Samsung P7510. This powerful, “go anywhere” device, puts the best of the web and mobile computing at your fingertips in a lightweight, highly versatile platform that fits your active lifestyle. Built on the Google Android operating system, the P7510 gives you access to thousands of useful and entertaining applications to enrich your mobile web experience.

With integrated wireless access and a responsive touch screen, you can read books and newspapers on the go; stay up-to-date on the latest news, sports, and weather; manage your multimedia and business files; and browse the web for maps, business locations, and more.

## Read me first

- Please read all safety precautions and this manual carefully before using your device to ensure safe and proper use.
- The descriptions in this manual are based on the default settings of your device.
- Images and screenshots used in this user manual may differ in appearance from the actual product.
- Content in this user manual may differ from the product, or from software provided by service providers or carriers, and is subject to change without prior notice. Refer to [www.samsung.com](http://www.samsung.com) for the latest version of the user manual.
- Available features and additional services may vary by device, software, or service provider.
- Formatting and delivery of this user manual is based on Google Android operating systems and may vary depending on the user’s operating system.
- Applications and their functions may vary by country, region, or hardware specifications. Samsung is not liable for performance issues caused by third-party applications.

- Samsung is not liable for performance issues or incompatibilities caused by user editing of registry settings.
- You may upgrade your mobile device's software by accessing [www.samsung.com](http://www.samsung.com).
- Sound sources, wallpapers, and images provided in this device are licenced for limited use between Samsung and their respective owners. Extracting and using these materials for commercial or other purposes is an infringement of copyright laws. Samsung is not liable for such copyright infringement by the user.
- Please keep this manual for future reference.

## Instructional icons

Before you start, familiarise yourself with the icons you will see in this manual:



**Warning**—situations that could cause injury to yourself or others



**Caution**—situations that could cause damage to your device or other equipment



**Note**—notes, usage tips, or additional information



**Refer to**—pages with related information; for example: ► p.12 (represents “see page 12”)



**Followed by**—the order of options or menus you must select to perform a step; for example: From the Home screen, open the application list and select **Settings** → **Wireless & networks** (represents **Settings**, followed by **Wireless & networks**)



**Square brackets**—device keys; for example: [⓪] (represents the Power/Lock key)

## Copyright

Copyright © 2011 Samsung Electronics

This user manual is protected under international copyright laws.

No part of this user manual may be reproduced, distributed, translated, or transmitted in any form or by any means, electronic or mechanical, including photocopying, recording, or storing in any information storage and retrieval system, without the prior written permission of Samsung Electronics.

## Trademarks

- SAMSUNG and the SAMSUNG logo are registered trademarks of Samsung Electronics.
- The Android logo, Google Search™, Google Maps™, Google Mail™, YouTube™, Android Market™, and Google Talk™ are trademarks of Google, Inc.
- Bluetooth® is a registered trademark of the Bluetooth SIG, Inc. worldwide.
- Oracle and Java are registered trademarks of Oracle and/or its affiliates. Other names may be trademarks of their respective owners.
- Windows Media Player® is a registered trademark of Microsoft Corporation.
- Wi-Fi®, the Wi-Fi CERTIFIED logo, and the Wi-Fi logo are registered trademarks of the Wi-Fi Alliance.
- All other trademarks and copyrights are the property of their respective owners.

# CE 0168 !

# Contents

<b>Assembling</b> .....	<b>8</b>
Unpack .....	8
Charge the battery .....	9
<b>Getting started</b> .....	<b>11</b>
Turn your device on and off .....	11
Get to know your device .....	12
Use the touch screen .....	15
Get to know the Home screen .....	17
Access applications .....	20
Customise your device .....	20
Enter text .....	24
<b>Web</b> .....	<b>26</b>
Browser .....	26
Pulse .....	31
Market .....	32
YouTube .....	33
Maps .....	34
Latitude .....	35
Places .....	36
Navigation .....	36
Search .....	37
Samsung Apps .....	38

<b>Communication</b>	<b>39</b>
Google Mail	39
Email	41
Talk	44
<b>Entertainment</b>	<b>46</b>
Music	46
MusicHub	48
Camera	48
Gallery	56
Movie Studio	58
<b>Personal information</b>	<b>60</b>
Contacts	60
Calendar	62
<b>Connectivity</b>	<b>64</b>
PC connections	64
Wi-Fi	66
Bluetooth	67
GPS	70
VPN connections	71
<b>Tools</b>	<b>73</b>
Calculator	73
Clock	73
Downloads	74
Voice Search	74
Quickoffice	75

<b>Settings</b> .....	<b>77</b>
Access the Settings menu .....	77
Wireless & networks .....	77
Sound .....	78
Screen .....	79
Location & security .....	79
Applications .....	80
Accounts & sync .....	81
Privacy .....	81
Storage .....	82
Language & input .....	82
Accessibility .....	84
Date & time .....	84
About tablet .....	84
<b>Troubleshooting</b> .....	<b>85</b>
<b>Safety precautions</b> .....	<b>88</b>
<b>Index</b> .....	<b>97</b>

# Assembling

## Unpack

Check your product box for the following items:

- Mobile device
- USB power adapter
- PC data cable
- Headset
- Quick start guide

 Use only Samsung-approved software. Pirated or illegal software may cause damage or malfunctions that are not covered by your manufacturer's warranty.



- 
- The items supplied with your device may vary depending on the software and accessories available in your region or offered by your service provider.
  - You can obtain additional accessories from your local Samsung dealer.
  - The supplied accessories perform best for your device.
  - Accessories other than the supplied ones may not be compatible with your device.



## Charge the battery

Your device has a built-in battery. Before using the device for the first time, you must charge the battery.

 Use only Samsung-approved chargers. Unauthorised chargers can cause batteries to explode or damage your device.

-  Charge the battery only with a charger. You cannot charge the battery with the PC data cable.
- When your battery is low, the device will emit a warning tone and display a low battery message. The battery icon  will also be empty and turn red. If the battery level becomes too low, the device will automatically power off. Recharge your battery to continue using your device.

*I* Connect the PC data cable to the USB power adapter and then plug the end of the PC data cable into the multifunction jack.

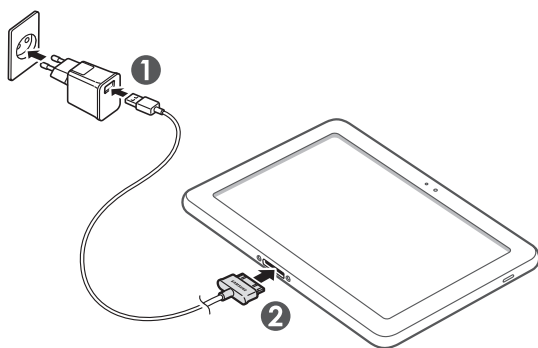

 Connecting the travel adapter improperly may cause serious damage to the device. Any damage caused by misuse is not covered by the warranty.

2 Plug the USB power adapter into a power outlet.



- You can use the device while it is charging, but it may take longer to fully charge the battery.
- While the device is charging, the touch screen and the touch keys may not function due to an unstable power supply. If this happens, unplug the USB power adapter from the power outlet or unplug the PC data cable from the device.
- While charging, the device may heat up. This is normal and should not affect your device's lifespan or performance.
- If your device is not charging properly, bring your device and the charger to a Samsung Service Centre.

3 When the battery is fully charged (the battery icon is no longer moving), unplug the USB power adapter and PC data cable from the device and then from the power outlet.



To save energy, unplug the travel adapter when not in use. The travel adapter does not have a power switch, so you must unplug the travel adapter from the outlet to interrupt the power supply. The travel adapter should remain close to the socket when in use.

# Getting started

## Turn your device on and off

To turn on your device,

- 1 Press and hold [⏻].
- 2 If you turn on your device for the first time, follow the on-screen instructions to set up your device.

To turn off your device, press and hold [⏻] and then select **Power off** → **OK**.

### › Switch to Flight mode

In Flight mode, you can disable all wireless connections and use non-network services in areas where wireless devices are prohibited, such as aeroplanes and hospitals.

To activate Flight mode, go to **Settings** → **Wireless & networks** → **Flight mode**. You can also press and hold [⏻] and then select **Flight mode**.

To deactivate Flight mode and use wireless connections, go to **Settings** → **Wireless & networks** and clear the check box next to **Flight mode**.

# Get to know your device

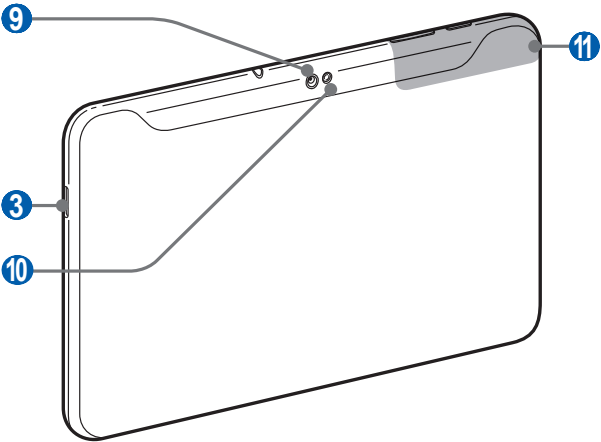
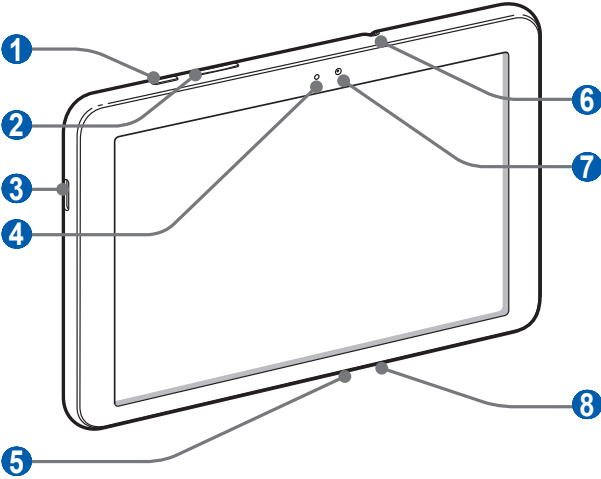

## > Device layout



Number	Function
①	Power/Lock key
②	Volume key
③	Speaker
④	Light sensor
⑤	Multifunction jack
⑥ <sup>1</sup>	Headset jack
⑦	Front camera lens
⑧	Mouthpiece
⑨	Rear camera lens
⑩	Flashbulb
⑪	Internal antenna

1. Connecting a headset to your device improperly can damage the headset jack or the headset.

## › Keys

Key	Function
 Power/ Lock	Turn on the device (press and hold); Access the quick menus (press and hold); Lock the touch screen.
 Volume	Adjust the device's volume.

## › Indicator icons



Icons shown on the display may vary depending on your region or service provider.



Icon	Definition
	Open WLANs available
	WLAN activated
	Bluetooth activated
	Receiving GPS data
	Synchronised with the web
	Uploading data
	Downloading data
	Connected to PC
	WLAN hotspot activated
	New email message
	New Google Mail
	Alarm activated
	Event notification
	Roaming (outside of normal service area)
	Flight mode activated
	Music playback in progress
	Error occurred or caution required
	Battery power level

Icon	Definition
	Unable to charge
1□:□□	Current time

1. If you use a charger that is not approved by Samsung, this indicator will not appear.

## Use the touch screen

Your device's touch screen lets you easily select items or perform functions. Learn basic actions to use the touch screen.

-  • To avoid scratching the touch screen, do not use sharp tools.
- Do not allow the touch screen to come into contact with other electrical devices. Electrostatic discharges can cause the touch screen to malfunction.
- Do not allow the touch screen to come into contact with water. The touch screen may malfunction in humid conditions or when exposed to water.
-  • For optimal use of the touch screen, remove the screen protection film before using your device.
- Your touch screen has a layer that detects small electrical charges emitted by the human body. For best performance, tap the touch screen with your fingertip. The touch screen will not react to touches of sharp tools, such as a stylus or pen.

You can control your touch screen with the following actions:

- Tap: Touch once with your finger to select or launch a menu, option, or application.
- Drag: Tap and drag your finger up, down, left, or right to move to items on lists.
- Tap and hold: Tap an item and hold it for more than 2 seconds to open a pop-up option list.
- Drag and drop: Tap and hold your finger on an item, and then drag your finger to move the item.
- Double-tap: Tap twice quickly with your finger to zoom in or out while viewing photos.

## › Rotate the touch screen

Your device has a built-in motion sensor that detects its orientation. If you rotate the device, the interface will automatically rotate according to the orientation.

To set the interface to keep the orientation,

- 1 Select the system bar at the bottom right of the screen and then select .
- 2 Next to **Lock screen orientation**, drag **ON** to the right.

## › Lock or unlock the touch screen

When you do not use the device for a specified period, your device turns off the touch screen and automatically locks the touch screen to prevent any unwanted device operations. To manually lock the touch screen, press [⏻].

To unlock, turn on the screen by pressing [⏻], and drag  in any direction until it reaches the border of the circle. If you set a screen lock, you need to enter your PIN or password, or draw a pattern. ► p. 22



# Get to know the Home screen

When the device is in Idle mode, you will see the Home screen. From the Home screen, you can view your device's status and access applications. Scroll left or right to a panel of the Home screen.

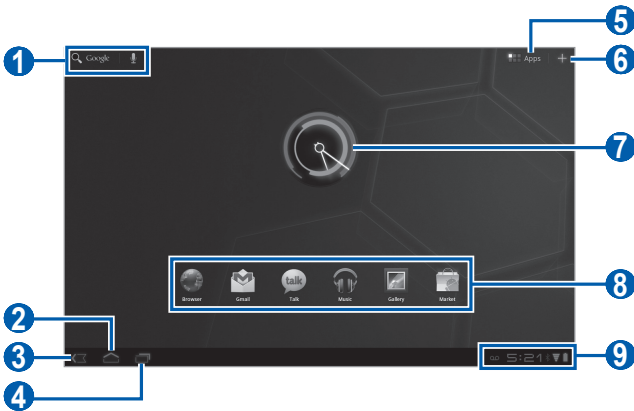

 The above screen may differ depending on your region or service provider.

Number	Function
1	Search the web with the Google Search widget.
2	Return to the Home screen.
3	Return to the previous screen.
4	Open the list of recent applications.
5	Access the application list.
6	Customise the Home screen.
7	View the current time; Set a new alarm.
8	Launch applications with shortcuts.
9	Display indicator icons and your device's current status; Open the notifications panel.

## › Add items to the Home screen

You can customise the Home screen by adding shortcuts to applications or items in applications, widgets, or folders.

To add an item to the Home screen,

- 1 From the Home screen, select .
- 2 Select an item category.
  - **Widgets:** Add widgets. Widgets are small applications that provide convenient functions and information on your Home screen.
  - **App Shortcuts:** Add shortcuts to applications on the Home screen.
  - **Wallpaper:** Set a background image.
  - **More:** Add shortcuts to items, such as bookmarks, contacts, and maps.
- 3 Select an item to add to the Home screen.

## › Move items on the Home screen

- 1 Tap and hold an item to move until the Home screen grid appears.
- 2 Drag the item to the location you want.

## › Remove items from the Home screen

- 1 Tap and hold an item to remove.  
The trash bin appears at the top right of the Home screen.
- 2 Drag the item to the trash bin.
- 3 When the item and the trash bin turn red, release the item.

## › Add a shortcut to an application

- 1 From the application list, tap and hold an application icon and drag it to a Home screen panel at the bottom of the screen.  
The shortcut icon for the application is added to the Home screen.
- 2 Move the icon to the location you want or move it to another panel of the Home screen.

## › Use the notifications summary panel

From the Home screen or while using an application, select the right side of the system bar, and then select  on the notifications panel.



You can view the device's current status and use the following options:

- **Flight mode:** Activate or deactivate Flight mode.
- **Wi-Fi:** Activate or deactivate the WLAN feature.
- **Lock screen orientation:** Activate or deactivate the rotation lock.
- **Brightness:** Adjust the brightness of the display.
- **Notifications:** Set the device to alert you for various events.
- **Settings:** Access the Settings menu.



Available options may vary depending on your region or service provider.

## Access applications

- 1 From the Home screen, select **Apps** to access the application list.
- 2 Select **All** → an application.  
To view downloaded applications, select **Downloaded**.
- 3 Select  to return to the previous screen; Select  to return to the Home screen.

### › Access recent applications

- 1 Select  to open the list of applications you have accessed recently.
- 2 Select an application.

## Customise your device

Get more from your device by customising it to match your preferences.

### › Change the language of the display

- 1 From the Home screen, open the application list and select **Settings** → **Language & input** → **Select language**.
- 2 Select a language you want.

### › Set the current time and date

- 1 From the Home screen, open the application list and select **Settings** → **Date & time**.
- 2 Select your time zone, set the time and date, and change other options.

## › Turn the touch tone on or off

From the Home screen, open the application list and select **Settings** → **Sound** → **Audible selection**.

## › Adjust the device's volume

- 1 Press the Volume key up or down.
- 2 Select  and drag the sliders to adjust the volume level for system sounds and notifications.

## › Switch to Silent mode

Press and hold [] and select **Silent mode** to mute or unmute your device.

## › Select a wallpaper for the Home screen

- 1 From the Home screen, select  → **Wallpaper**.
- 2 Select an image folder → an image.
- 3 If you selected a live wallpaper, select **Set wallpaper**.  
If you selected an image from Gallery, move or resize the rectangle to select a portion of the image, and then select **OK**.



Samsung is not responsible for any use of default images or wallpapers provided on your device.

## › Activate animation for switching windows

You can set a transition effect between windows while using the device.

- 1 From the Home screen, open the application list and select **Settings** → **Screen** → **Animation**.
- 2 Select an animation option.

## › Adjust the brightness of the display

- 1 From the Home screen, open the application list and select **Settings** → **Screen** → **Brightness**.
- 2 Clear the check box next to **Automatic brightness**.
- 3 Drag the slider to adjust the level of brightness.
- 4 Select **OK**.



The brightness level of the display will affect how quickly the device consumes battery power.

## › Set a screen lock

You can lock the touch screen with an unlock pattern or password to prevent unauthorised people from using the device without your permission.



- Once you set a screen lock, your device will require an unlock code each time you turn it on or unlock the touch screen.
- If you forget your PIN or password, bring your device to a Samsung Service Centre to reset it.
- Samsung is not responsible for any loss of security codes or private information or other damages caused by illegal software.

## Set an unlock pattern

- 1 From the Home screen, open the application list and select **Settings** → **Location & security** → **Configure lock screen** → **Pattern**.
- 2 See the on-screen instructions and example patterns and select **Next**.
- 3 Draw a pattern by dragging your finger to connect at least 4 dots.
- 4 Select **Continue**.
- 5 Draw a pattern again to confirm.
- 6 Select **Confirm**.

## Set an unlock PIN code

- 1 From the Home screen, open the application list and select **Settings** → **Location & security** → **Configure lock screen** → **PIN**.
- 2 Enter a new PIN (numeric) and select **Continue**.
- 3 Enter the PIN again and select **OK**.

## Set an unlock password

- 1 From the Home screen, open the application list and select **Settings** → **Location & security** → **Configure lock screen** → **Password**.
- 2 Enter a new password (alphanumeric) and select **Continue**.
- 3 Enter the password again and select **OK**.

## Enter text

You can enter text by selecting characters on the virtual keypad.

 You cannot enter text in some languages. To enter text, you should change the writing language to one of the supported languages. ► p. 82

### ► Enter text using the Android keyboard

Enter text by selecting alphanumeric keys and you can use the following keys:

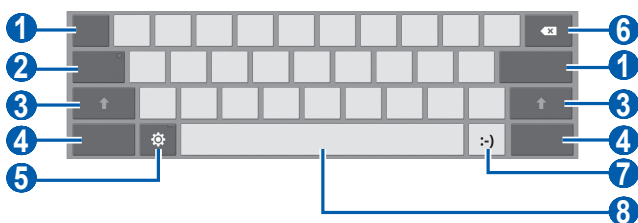



Number	Function
1	Move the cursor to the next text input field.
2	Enter text in capital lock.
3	Change case.
4	Switch between Number/Symbol mode and ABC mode.
5	Access the keypad settings; Change the keypad type or activate the voice input feature (tap and hold).



Number	Function
6	Clear your input.
7	Insert an emoticon; Open the emoticon list (tap and hold).
8	Insert a space.

## › Copy and paste text

While you are entering text, you can use the copy and paste feature to use text in other applications.

- 1 Tap and hold a word.
- 2 Drag  or  to select the text you want.
- 3 Select **Copy** to copy, or **Cut** to cut the text onto the clipboard.
- 4 In another application, tap and hold the text input field.
- 5 Select **Paste** to insert the text from the clipboard into the text input field.

# Web

Web services require a data connection. Contact your operator to choose the best data plan.

## Browser

Learn to access and bookmark your favourite web pages.



- You may incur additional charges for accessing the web and downloading data. For details, contact your service provider.
- The web browser menu may be labelled differently depending on your service provider.
- Available icons may vary depending on your region or service provider.

### › Browse web pages

*I* From the Home screen, open the application list and select **Browser** to launch your homepage.







To access a specific web page, select the URL input field, enter the web address of the web page, and select ▶.

## 2 Navigate web pages with the following keys:



Number	Function
1	Close the current tab.
2	Move backward or forward to web pages in history.
3	Reload the current web page; While the device is loading web pages, this icon changes to X.
4	Open a new tab.
5	Search for information.
6	Access a list of web browser options.
7	Open a list of saved bookmarks and recent internet history.
8	Bookmark the current web page.



While browsing the web page, use the following options:

- To zoom in or out, tap the screen with two fingers and spread them apart (move your fingers closer together to zoom out).
- To open a new tab, select  → **New tab**.
- To open a new tab without saving cookies, select  → **New incognito tab**.
- To search for text on the web page, select  → **Find on page**.
- To send the web address of the web page to others, select  → **Share page**.
- To view page details, select  → **Page info**.
- To view the items downloaded from the web, select  → **Downloads**.
- To customise browser settings, select  → **Settings**.

## › Search for information by voice



This feature may be unavailable depending on your region or service provider.

- 1 From the Home screen, open the application list and select **Browser**.
- 2 Select .
- 3 Select  and say a keyword into your device's microphone.

The device searches for information and web pages related with the keyword.

## › Open multiple pages



You can open multiple pages and switch back and forth between them.

- 1 From the Home screen, open the application list and select **Browser**.
- 2 Select  to open a new tab.
- 3 Access another web page on the new tab.
- 4 To switch back and forth between currently open tabs, select the title of a tab.

## › Bookmark your favourite web pages

If you know the web address of the web page, you can manually add a bookmark.

### Add a bookmark

- 1 From the Home screen, open the application list and select **Browser**.
- 2 Select  → **Add bookmark...**  
You can also select  to bookmark the current web page.
- 3 Enter a page title and a web address.  
To bookmark the web page you were viewing, skip to step 5.
- 4 Select the **Bookmarks** drop-down menu and select a bookmark location to add (if necessary).
- 5 Select **OK**.

To use bookmark options, select , tap and hold a bookmark:

- To open the web page in the current tab, select **Open**.
- To open the web page in a new tab, select **Open in new tab**.
- To edit the bookmark, select **Edit bookmark**.
- To add the bookmark shortcut to the Home screen, select **Add shortcut to home**.
- To send the web address of the web page to others, select **Share link**.
- To copy the web address of the web page, select **Copy link URL**.
- To delete the bookmark, select **Delete bookmark**.
- To use the web page as your homepage of the browser, select **Set as homepage**.

## Create a bookmark folder

- 1 From the Home screen, open the application list and select **Browser**.
- 2 Select , and then tap and hold a bookmarked web page.
- 3 Select **Edit bookmark**.
- 4 Select the **Bookmarks** drop-down menu.
- 5 Select **Other folder...** → **New folder**.
- 6 Enter a name for the bookmark folder and select **OK**.





## › Access recent history

- 1 From the Home screen, open the application list and select **Browser**.
- 2 Select  → **History**.
- 3 Select a web page to access.



## Pulse

You can use the Pulse reader to add feeds for your favourite news topics and read news articles on your device.

## › Read feeds

- 1 From the Home screen, open the application list and select **Pulse**.
- 2 If you are launching this application for the first time, tap the screen to clear the hint.
- 3 Select  to update feeds.
- 4 Scroll up or down to select a feed source.
- 5 Scroll left or right and select a feed.
- 6 While reading a feed, use the following options:
  - To upload a feed to community websites, select  or .
  - To send a feed to others, select .
  - To return to a feed list, select .

## › Manage feed sources

- 1 From the Home screen, open the application list and select **Pulse**.
- 2 Select  to view the feed source list.
- 3 Select  or  to add or delete a feed.

## › Customise the reader settings

- 1 From the Home screen, open the application list and select **Pulse**.
- 2 Select  → **Settings** to customise the display or sync settings for the Pulse reader.

## Market

Based on the Android platform, your device's functionality can be extended by installing additional applications. Android Market provides you an easy and quick way to shop for games and mobile applications.



- This feature may be unavailable depending on your region or service provider.
- Your device will save user files from downloaded applications to the internal memory.



## › Download and install an application

- 1 From the Home screen, open the application list and select **Market**.  
You can also select  at the top right of the screen.
- 2 If you are launching this application for the first time, read the terms and conditions and select **Accept**.
- 3 Search for a file or application and download it.

## › Uninstall an application

- 1 From the Home screen, open the application list and select **Market**.
- 2 Select **My apps**.
- 3 Select the item you want to delete.
- 4 Select **Uninstall**.

## YouTube

Learn to view and upload videos via YouTube.

 This feature may be unavailable depending on your region or service provider.

## › Watch videos

- 1 From the Home screen, open the application list and select **YouTube**.
- 2 Select a video from the list.
- 3 Select a video screen →  to display a full screen.
- 4 Control playback with the virtual keys.







## › Upload videos

- 1 From the Home screen, open the application list and select **YouTube**.
- 2 Select **Your Channel**.
- 3 Select **Upload** and then select a video.
- 4 Enter details for the upload and select **Upload**.



## Maps

Learn to use Google Maps™ to find your location, search the map for streets, cities, or countries, and get directions.

### › Search for a specific location

- 1 From the Home screen, open the application list and select **Maps**.
- 2 If you are launching this application for the first time, select **OK**.  
The map will display your current location.
- 3 Select **Search Maps**.
- 4 Enter a keyword for the location and select 
  - To search for a location by voice, select .
  - To view your current location, select .
  - To search for a place around you, select .
  - To get directions to a specific destination, select .
  - To add layers to the map, select .
  - To access a list of other options, select .
  - To zoom in or out, place two fingers on the screen and spread them apart (move your fingers closer together to zoom out) or double-tap the screen.

## › Get directions to a specific destination

- 1 From the Home screen, open the application list and select **Maps**.
- 2 Select .
- 3 Enter the addresses of the starting location and the ending location.  
To enter an address from your contact list or point the location on the map, select  → **Contacts** or **Point on map**.
- 4 Select a travel method (car, bus, or walk) and select **Go**.
- 5 Select a travel route to view details of your trip (if necessary).
- 6 When you are finished, select  → **Clear Map**.

## Latitude

Learn to share your location with your friends and view friends' locations via Google Latitude™.

 This feature may be unavailable depending on your region or service provider.



- 1 From the Home screen, open the application list and select **Latitude**.  
The device automatically joins Latitude.
- 2 Select  → **Select from Contacts** or **Add via email address**.
- 3 Select friends you want to add, or enter an email address and select **Add friends**.

- 4 Select **Yes**.  
When your friend accepts your invitation, you can share locations.
- 5 Select a friend from the list.  
Your friends' locations are marked with their photos on the map.

## Places

Learn to search for a place around you.

 This feature may be unavailable depending on your region or service provider.

- 1 From the Home screen, open the application list and select **Places**.
- 2 Select a category.  
Your device searches for places around your current location that are related to the category.
- 3 Select a place name to view its details.
- 4 To view the place on the map, select .  
To view the route to the place, select .

## Navigation

Learn to use the GPS navigation system to find and show your destination with voice guidance.

 This feature may be unavailable depending on your region or service provider.

- 1 From the Home screen, open the application list and select **Navigation**.
- 2 If you are launching this application for the first time, select **Accept**.
- 3 Enter your destination by using one of the following methods:
  - **Speak Destination:** Speak your destination such as "Navigate to destination."
  - **Type Destination:** Enter your destination with the virtual keypad.
  - **Contacts:** Select your destination from addresses of your contacts.
  - **Starred Places:** Select your destination from the list of your starred places.
- 4 Select **Install** to use voice-guided navigation (if necessary).
- 5 Follow the route indicated on the map and the voice guide.  
To view directions in text form, select .
- 6 To end the navigation, press [] → **Exit Navigation**.

## Search

You can search for applications and files in your device and specific data on the web.

- 1 From the Home screen, open the application list and select **Search**.
- 2 Enter a letter or a word of the data to search for.
- 3 Select the item's name you want to access.

## Samsung Apps

Samsung Apps allows you to simply and easily download an abundance of applications directly to your device. Featuring a wealth of games, news, reference, social networking, navigation, health related applications and more, Samsung Apps gives you instant access to a huge choice of mobile experience.

Your device gets smarter with fully optimised applications from Samsung Apps. Explore amazing applications and make your mobile life even better.



- This feature may be unavailable depending on your region or service provider.
- For details, please visit [www.samsungapps.com](http://www.samsungapps.com).

- 1 From the Home screen, open the application list and select **Samsung Apps**.
- 2 Search for and download applications as desired.

# Communication



## Google Mail

You can retrieve new email messages from Google Mail™ to your Inbox. When you access this application, the Inbox screen appears. The total number of unread messages displays in the title bar and unread messages display in bold.



- This feature may be unavailable depending on your region or service provider.
- This Google Mail menu may be labelled differently depending on your service provider.















### › Send an email message

- 1 From the Home screen, open the application list and select **Google Mail**.
- 2 Select .
- 3 Enter a name or address in the recipient field.
- 4 Enter a subject and message.
- 5 Select  → a file to attach an image file.
- 6 Select **Send** to send the message.

### › View an email message

- 1 From the Home screen, open the application list and select **Google Mail**.
- 2 Select an email message.

From the message view, use the following options:

- To move to the previous or next message, select **Older** or **Newer**.
- To search for an email message, select .
- To create a new message, select .
- To archive the message, select .
- To delete the message, select .
- To make the message as unread, select  → **Mark unread**.
- To register the message to the spam list, select  → **Report spam**.
- To hide the message, select  → **Mute**. To move the message to the inbox folder, select **All Mail** and drag the message to **Inbox**.
- To reload the messages, select  → **Refresh**.
- To customise the email settings, select  → **Settings**.
- To add a label to a message, select .
- To reply to the message, select .
- To reply to the message including all recipients, select .
- To forward the message to other people, select .
- To add a star to the message, select .
- To view an attachment, select **View**. To save it to your device, select **Save**.



## Email



Learn to send or view email messages via your personal or company email account.

### › Set up an email account

- 1 From the Home screen, open the application list and select **Email**.
- 2 Enter your email address and password.
- 3 Select **Next** (for general email accounts) or **Manual setup** (for other company email accounts).
- 4 Follow the on-screen instructions.
- 5 To add more email accounts, select  → **Account settings** → **Add account** and repeat steps 2-4.

When you are finished setting up the email account, the email messages are downloaded to your device. If you have created more than two accounts, you can switch between email accounts; Select an account name at the top left of the screen and select the one you want to retrieve messages from.

## › Send an email message

- 1 From the Home screen, open the application list and select **Email** → an email account.
- 2 Select .
- 3 Add recipients of your message.  
Enter email addresses manually, separating them with a semicolon or a comma.
- 4 Select + **Cc/Bcc** and add more recipients.
- 5 Select the subject field and enter a subject.
- 6 Select the text input field and enter your email text.
- 7 Select  → a file to attach an image file.
- 8 Select **Send** to send the message.











 If you are offline or outside your service area, the message will be held in the outbox until you are online and in your service area.

## › View an email message

When you open an email account, you can view previously retrieved emails offline or connect to the email server to view new messages. After retrieving email messages, you can view them offline.

- 1 From the Home screen, open the application list and select **Email** → an email account.
- 2 Select  to update the message list.
- 3 Select an email message.

From the message view, use the following options:

- To move to the previous or next message, select **Older** or **Newer**.
- To create a new message, select .
- To reload the messages, select .
- To move the message to another folder, select .
- To delete the message, select .
- To make the message as unread, select  → **Mark as unread**.
- To customise the settings for the account, select  → **Account settings**.
- To reply to the message, select .
- To reply to the message including all recipients, select .
- To forward the message to other people, select .
- To add a star to the message, select .
- To view an attachment, select **View**. To save it to your device, select **Save**.

# Talk

Learn to chat with friends and family via Google Talk™.



This feature may be unavailable depending on your region or service provider.

## › Set your status

- 1 From the Home screen, open the application list and select **Talk**.
- 2 Select your account.
- 3 Customise your status, image, and message to display.

## › Add friends to your friend list

- 1 From the Home screen, open the application list and select **Talk**.
- 2 Enter your Google account and password and select **Sign in** (if necessary).  
The friend list shows all of your Google Talk contacts at a glance.
- 3 Select .
- 4 Enter an email address of the friend and select **Send invitation**.

When your friend accepts the invitation, the friend is added to your friend list.

## › Start a chat

- 1 From the Home screen, open the application list and select **Talk**.
- 2 Select a friend from the friend list. The chat screen opens.
- 3 Enter your message and select ►.  
To add a friend to a chat, select ▲ → **Add to chat**.
- 4 To end the chat, select ✕.

# Entertainment

## Music

Learn to listen to your favourite music while on the go with the music player. The music player supports the following file formats: (Codec:)



- Some file formats are not supported depending on the software of the device.
- If the file size exceeds the available memory, an error can occur when you open files.

### › Add music files to your device

Start by transferring files to your device:



- Download from the wireless web. ▶ p. 26
- Download from a PC with Samsung Kies. ▶ p. 64
- Receive via Bluetooth. ▶ p. 69
- Synchronise with Windows Media Player 11. ▶ p. 65

## › Play music



After transferring music files to your device,

- 1 From the Home screen, open the application list and select **Music**.
- 2 Select **New and recent** → a music category → a music file.
- 3 Control playback with the virtual keys.

While playing music, use the following options:

- To add the music file to a playlist, select  → **Add to playlist**.
- To view music files by artist, select  → **More by artist**.
- To view help information about using the music player, select  → **Help**.

## › Create a playlist

- 1 From the Home screen, open the application list and select **Music** → **New and recent** → **Playlists**.
- 2 Select .
- 3 Enter a title for your new playlist and select **OK**.
- 4 To add music files to the playlist, play a file and select  → **Add to playlist** → the new playlist.

## MusicHub

You can access the online music store, and search for and buy your favourite songs. You can also add a music file to your wish list and play downloaded music files.



This feature may be unavailable depending on your region or service provider.

- 1 From the Home screen, open the application list and select **MusicHub**.
- 2 If you are launching this application for the first time, select the check box next to **Skip this screen for 90 days** and select **Confirm**.
- 3 Search for songs, and preview or buy your favourite songs.

## Camera

Learn how to capture and view photos and videos. You can take photos at resolutions up to 2048 x 1536 pixels (3 megapixels) and videos at resolutions up to 1280 x 720 pixels.



- The camera interface appears only in the landscape orientation.
- The camera automatically turns off when you do not use it for a specified period.
- The memory capacity may differ depending on the shooting scene or shooting conditions.



## › Capture a photo

- 1 From the Home screen, open the application list and select **Camera** to turn on the camera.
- 2 Aim the lens at the subject and make any necessary adjustments.

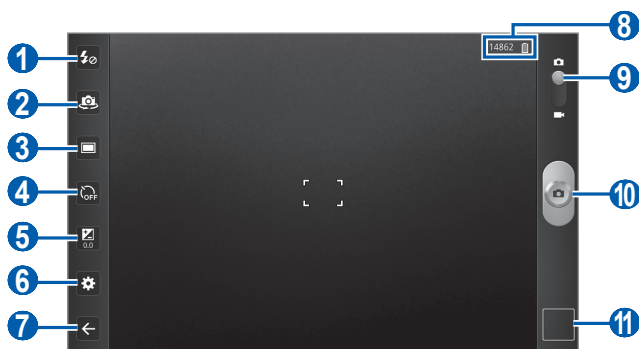





Number	Function
1	Change the flash setting; You can manually turn the flash on or off, or set the camera to automatically use the flash when needed.
2	Switch between the front and rear camera lenses.
3	Change the scene mode.
4	Select the length of the delay before the camera takes a photo.
5	Adjust the exposure value.
6	Change the camera settings.
7	Return to the previous screen.

Number	Function
8	Check the camera status. <ul style="list-style-type: none"> <li>• 14852 : Number of photos you can take (according to available memory)</li> <li>•  : Battery level</li> </ul>
9	Switch to the camcorder.
10	Capture a photo.
11	Open the image viewer to view photos you captured.

3 Tap where you want to focus on the preview screen. The focus frame moves to the place you tap and changes to green when the subject is in focus.



4 Select  to take a photo. The photo is saved automatically.

After taking photos, select the image viewer icon to view the captured photos.

- To view more photos, scroll left or right. You can also tap the screen and scroll through the thumbnails of photos at the bottom of the screen.
- To zoom in or out, place two fingers on the screen and spread them apart (move your fingers closer together to zoom out) or double-tap the screen.
- To start a slideshow of images, select . Tap the screen to stop the slideshow.
- To send a photo to others, select .
- To delete a photo, select .
- To use additional features, select .



## › Capture a photo by using preset options for various scenes

Your camera provides you with predefined settings for various scenes. You can simply select the proper mode for your shooting condition and subjects. For example, when you take photos at night, select the night mode that uses an extended exposure.

- 1 From the Home screen, open the application list and select **Camera** to turn on the camera.
- 2 Select  → **Scene mode** → a scene.
- 3 Make any necessary adjustments.
- 4 Select  to take a photo.



## › Capture a photo in Self shot mode

You can take photos of yourself conveniently using the front camera lens.

- 1 From the Home screen, open the application list and select **Camera** to turn on the camera.
- 2 Select .
- 3 Make any necessary adjustments.
- 4 Select  to take a photo.



## › Capture a photo in Smile shot mode

Your camera can recognise people's faces and help you take photos of their smiling faces.

- 1 From the Home screen, open the application list and select **Camera** to turn on the camera.
- 2 Select  → **Smile shot**.
- 3 Make any necessary adjustments.
- 4 Select .
- 5 Aim the camera lens at your subject.  
Your device recognises people in an image and detects their smiles. When the subject smiles, the device automatically takes a photo.



## › Capture a panoramic photo

You can take wide panoramic photos using Panorama shooting mode. This mode is convenient for photographing landscapes.

- 1 From the Home screen, open the application list and select **Camera** to turn on the camera.
- 2 Select  → **Panorama**.
- 3 Make any necessary adjustments.
- 4 Select  to take the first photo.
- 5 Slowly move the device in any direction and align the green frame with the viewfinder.  
When you have aligned the green frame and viewfinder, the camera will automatically take the next photo.
- 6 Repeat step 5 to complete the panoramic photo.

## › Capture a photo of action

You can capture shots of a moving subject and then combine them into a single photo that shows the action.

- 1 From the Home screen, open the application list and select **Camera** to turn on the camera.
- 2 Select  → **Action shot**.
- 3 Make any necessary adjustments.
- 4 Select  to take the first photo.
- 5 Move the device to follow the moving subject.  
The device automatically takes the next photos.
- 6 Continue to follow the subject until the device has captured all the shots necessary for the action photo.

## › Customise camera settings

Before taking a photo, select  to access the following options:

Option	Function
Shooting mode	Change the shooting mode.
Scene mode	Change the scene mode.
Focus mode	Take close-up photos or set the camera to focus on the subject.
Effects	Apply a special effect, such as sepia or black and white tones.
Resolution	Change the resolution option.
White balance	Adjust the colour balance according to lighting conditions.
Metering	Select a type of exposure metre.

Option	Function
Guidelines	Display the guidelines on the preview screen.
GPS Tag	Set the camera to include location information for your photos. To use this feature, you must activate location services. ► p. 70

## ► Record a video

- 1 From the Home screen, open the application list and select **Camera** to turn on the camera.
- 2 Drag the slider at the top right of the screen to switch to the camcorder.
- 3 Aim the lens at the subject and make any necessary adjustments.

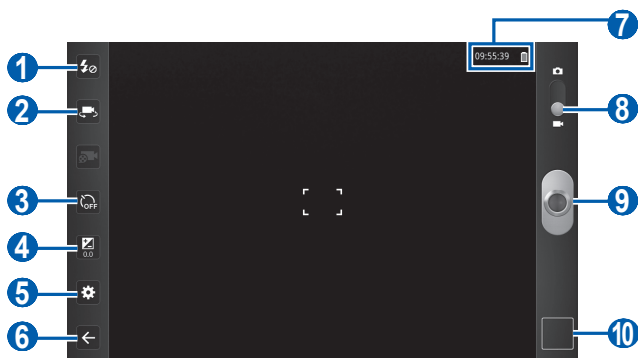

Number	Function
1	Change the flash setting; You can manually turn the flash on or off, or set the camera to automatically use the flash when needed.
2	Switch between the front and rear camera lenses.



Number	Function
3	Select the length of the delay before the camera starts recording a video.
4	Adjust the exposure value.
5	Change the camcorder settings.
6	Return to the previous screen.
7	Check the camcorder status. <ul style="list-style-type: none"> <li>• 09:55:39 : Length of video that can be recorded (according to available memory)</li> <li>•  : Battery level</li> </ul>
8	Switch to the camera.
9	Record a video.
10	Open the image viewer to view videos you recorded.



4 Select  to start recording.

5 Select  to stop recording.

The video is saved automatically.

After recording videos, select the image viewer icon to view the recorded videos.

- To view more videos, scroll left or right. You can also tap the screen and scroll through the thumbnails of videos at the bottom of the screen.
- To play a video, select .
- To start a slideshow of videos, select . Tap the screen to stop the slideshow.

- To send a video to others, select .
- To delete a video, select .
- To use additional features, select .

## › Customise camcorder settings

Before recording a video, select  to access the following options:

Option	Function
Effects	Apply a special effect, such as sepia or black and white tones.
Resolution	Change the resolution option.

## Gallery

Learn to view photos and play videos saved in your device's memory.

## › Supported file formats

Option	Function
Image	Extension:
Video	<ul style="list-style-type: none"> <li>• Extension:</li> <li>• Codec:</li> </ul>



- Some file formats are not supported depending on the software of the device.
- If the file size exceeds the available memory, an error can occur when you open files.



## › View a photo









1 From the Home screen, open the application list and select **Gallery**.

2 Select a folder.



 To view images of videos filtered by file types, select **By album** or **Images and videos** → an option.

3 Select a photo (with no icon) to view.

While viewing a photo, use the following options:











- To view more photos, scroll left or right.
- To zoom out or in, tap the screen with two fingers and spread them apart (move your fingers closer together to zoom out).
- To start a slideshow in the selected folder, select . Tap the screen to stop the slideshow.
- To send a photo to others, select .
- To delete a photo, select .
- To view photo details, select  → **Details**.
- To rotate a photo anti-clockwise, select  → **Rotate left**.
- To rotate a photo clockwise, select  → **Rotate right**.
- To set a photo as wallpaper or a caller image for a contact, select  → **Set picture as**.
- To crop an image from a photo, select  → **Crop**.







## › Play a video

- 1 From the Home screen, open the application list and select **Gallery**.
- 2 Select a folder.  
 To view images of videos filtered by file types, select **By album** or **Images and videos** → an option.
- 3 Select a video (with the  icon) to play.
- 4 Control playback with the virtual keys.

## Movie Studio

You can make a video using media files saved on your device.

- 1 From the Home screen, open the application list and select **Movie Studio**.
- 2 Select **New project**.
- 3 Enter a file name and select **OK**.
- 4 Select  or  to add an image or vide file.
- 5 Select an image or a video, and drag  at the left side of the screen to set a display duration of the media file. You can also drag  or  left or right to set a display duration of the media file.
- 6 Once you add a media file, use the following options:
  - To add a background music, select .
  - To apply an effect to the image or the video, select .
  - To add a title, select .
  - To add a transition effect at the beginning of the image or the video, select . To add a transition effect at the end of the image or the video, select .

- To delete the image or the video, select .
  - To play the video you created, select . To pause playback, select .
  - To restart playback, select .
  - To skip backward or forward, select  or .
- 7 When you are finished, select  → **Export movie**.
- 8 Set a size and quality for the video, and select **Export**.

# Personal information

## Contacts

Learn to create and manage a list of your personal or business contacts. You can save names, mobile phone numbers, home phone numbers, email addresses, birthdays and more for your contacts.

### › Create a contact

- 1 From the Home screen, open the application list and select **Contacts**.
- 2 Select **Create a new contact**.  
If you have a contact saved in your device, select **New**.
- 3 Enter contact information.
- 4 Select **Done** to add the contact to memory.

### › Retrieve contacts by your account



You can retrieve contacts by synchronising your assigned account.

- 1 From the Home screen, open the application list and select **Settings** → **Accounts & Sync**.
- 2 Select an account → **Sync Contacts** →  to synchronise your contact list.  
An updated contact list is retrieved and saved on your device automatically.

## › Find a contact

- 1 From the Home screen, open the application list and select **Contacts**.
- 2 Select **Find contacts** and enter the first few letters of a name.  
You can also drag your finger along the index on the left side to quickly scroll through the list.
- 3 Select the contact's name.

Once you find a contact, you can use the following options:

- To send an email message, select an email address.
- To edit the contact information, select .
- To set as a favourite, select .

## › Create a group of contacts

- 1 From the Home screen, open the application list and select **Contacts**.
- 2 Select **New** and select a text input field next to **Groups**.
- 3 Select **Create new group**.
- 4 Enter a name for the group and select **OK**.

To view contacts by group, select **All contacts** → a group.

# Calendar

Learn to create and manage daily, weekly, or monthly events, and set alarms to remind yourself of important events.

## › Change the calendar view

- 1 From the Home screen, open the application list and select **Calendar**.
- 2 Select a view mode from the top of the calendar.
  - **Day:** Hourly blocks for one full day
  - **Week:** A list of scheduled appointments for the days in one full week
  - **Month:** Daily blocks for the current month

## › Create an event

- 1 From the Home screen, open the application list and select **Calendar**.
- 2 Select .
- 3 Enter the details of the event as required.
- 4 Select **Done**.

## › View events

To view today's schedule,

- 1 From the Home screen, open the application list and select **Calendar**.
- 2 Select .
- 3 Select an event to view its details.

To view events of a specific date,

- 1 From the Home screen, open the application list and select **Calendar**.
- 2 Select a date on the calendar.
- 3 Select an event to view its details.

## › Stop an event alarm

If you set an alarm for a calendar event, the event alarm icon will appear at the specified time.

- 1 Select  on the system bar.
- 2 Select a reminder to view more details about the event.
- 3 To snooze or dismiss the reminder, select **Snooze all** or **Dismiss all**.

# Connectivity

## PC connections

Learn to connect your device to a PC with a PC data cable in various USB connection modes. By connecting the device to a PC, you can synchronise files with Windows Media Player, transfer data to and from your device directly, and use the Samsung Kies program.

### › Connect with Samsung Kies

Ensure that Samsung Kies is installed on your PC. You can download the program from the Samsung website ([www.samsung.com/kies](http://www.samsung.com/kies)).

- 1 Using a PC data cable, connect the multifunction jack on your device to a PC. Samsung Kies will launch automatically.  
If Samsung Kies does not launch automatically, double-click the Samsung Kies icon on your PC.
- 2 Copy files from the PC to the device.  
Refer to the Samsung Kies help for more information.



## › Synchronise with Windows Media Player

Ensure that Windows Media Player is installed on your PC.

- 1 Using the PC data cable, connect the multifunction jack on your device to a PC with Windows Media Player installed.  
When connected, a pop-up window will appear on the PC.
- 2 Open Windows Media Player to synchronise music files.
- 3 Edit or enter your device's name in the pop-up window (if necessary).
- 4 Select and drag the music files you want to the sync list.
- 5 Start synchronisation.

## › Connect as a mass storage device

You can connect your device to a PC as a removable disk and access the file directory.

- 1 Using the PC data cable, connect the multifunction jack on your device to a PC.
- 2 Open the folder to view files.
- 3 Copy files from the PC to your device.



To disconnect the device from the PC, click the USB device icon on the Windows task bar and click the option to safely remove the mass storage device. Then remove the PC data cable from the PC. Otherwise, you may lose data stored on your device or damage your device.

## Wi-Fi

Learn to use your device's wireless networking capabilities to activate and connect to any wireless local area network (WLAN) compatible with the IEEE 802.11 a/b/g/n standards. You can connect to the internet or other network devices anywhere an access point or wireless hotspot is available.

 Your device uses non-harmonised frequency and is intended for use in all European countries. The WLAN can be operated in the EU without restriction indoors, but cannot be operated outdoors in France.

### ▶ Activate the WLAN feature

1 From the Home screen, open the application list and select **Settings** → **Wireless & networks** → **Wi-Fi settings**.

2 Select **Wi-Fi** to activate the WLAN feature.

 An active WLAN running in the background will consume battery power. To preserve battery power, activate the WLAN only when needed.

### ▶ Find and connect to a WLAN

1 From the Home screen, open the application list and select **Settings** → **Wireless & networks** → **Wi-Fi settings**.

The device will automatically search for available WLANs.

2 Select a network under **Wi-Fi networks**.

3 Enter a password for the network (if necessary).

4 Select **Connect**.

## › Add a WLAN manually

- 1 From the Home screen, open the application list and select **Settings** → **Wireless & networks** → **Wi-Fi settings** → **Add Wi-Fi network**.
- 2 Enter the SSID for the network and select the security type.
- 3 Set the security settings depending on the selected security type.
- 4 Select **Save**.

## Bluetooth

Bluetooth is a short-range wireless communications technology capable of exchanging information over a distance of about 10 m without requiring a physical connection.

You do not need to line up the devices to beam information with Bluetooth. If the devices are within range of one another, you can exchange information between them even if they are located in different rooms.



- Samsung is not responsible for the loss, interception, or misuse of data sent or received via the Bluetooth wireless feature.
- Always ensure that you share and receive data with devices that are trusted and properly secured. If there are obstacles between the devices, the operating distance may be reduced.
- Some devices, especially those that are not tested or approved by Bluetooth SIG, may be incompatible with your device.

## › Turn on the Bluetooth wireless feature

- 1 From the Home screen, open the application list and select **Settings** → **Wireless & networks** → **Bluetooth settings**.
- 2 Select **Bluetooth** to turn on the Bluetooth wireless feature.

## › Find and pair with other Bluetooth-enabled devices



- 1 From the Home screen, open the application list and select **Settings** → **Wireless & networks** → **Bluetooth settings** → **Find nearby devices**.
- 2 Select a device.
- 3 Enter a PIN for the Bluetooth wireless feature or the other device's Bluetooth PIN, if it has one, and select **OK**. Alternatively, select **Pair** to match the PIN between your device and the device.

When the owner of the other device enters the same PIN or accepts the connection, pairing is complete. If the pairing is successful, the device will automatically search for available services.



Some devices, especially headsets or hands-free car kits, may have a fixed Bluetooth PIN, such as 0000. If the other device has a PIN, you must enter it.

## › Send data using the Bluetooth wireless feature

- 1 Select a file or item, such as a contact, calendar event, or media file, from an appropriate application.
- 2 Select  → **Bluetooth**, or select  → **Share contact** → **Bluetooth**.
- 3 Search for and pair with a Bluetooth-enabled device.

## › Receive data using the Bluetooth wireless feature

- 1 From the Home screen, open the application list and select **Settings** → **Wireless & networks** → **Bluetooth settings** → **Discoverable**.  
Your device is visible to other Bluetooth devices for 120 seconds.
- 2 When prompted, enter the PIN for the Bluetooth wireless feature and select **OK** (if necessary).
- 3 Select **Accept** to confirm that you are willing to receive data from the device (if necessary).

Received data is saved to an appropriate application or folder according to its type. If you receive a contact file, select **Settings** → **Wireless & networks** → **Bluetooth settings** → **Show received files** → a contact file to import it to your phonebook.

## GPS

Your device is equipped with a global positioning system (GPS) receiver. Learn to activate location services.

To receive better GPS signals, avoid using your device in the following conditions:

- between buildings, in tunnels or underground passages, or inside buildings
- in poor weather
- around high voltage or electromagnetic fields



Do not touch the internal antenna area or cover this area with your hands or other objects while using the GPS functions.



This feature may be unavailable depending on your region or service provider.

### ▶ Activate location services

You must activate location services to receive location information and search the map.

- 1 From the Home screen, open the application list and select **Settings** → **Location & security**.
- 2 Adjust the following settings to activate location services:

Option	Function
Use wireless networks	Set to use WLAN and/or mobile networks for finding your location.
Use GPS satellites	Set to use the GPS satellite for finding your location.
Use location for Google Search	Set the device to use your current location for Google search and other Google services.

## VPN connections

You can create virtual private networks (VPN) and connect to your private network securely through a public network, such as the internet.



Your device should already be configured with internet access. If you have trouble accessing the internet, you need to edit connections. If you are not sure about the connection information to enter, ask your service provider.

### › Set up VPN connections

- 1 From the Home screen, open the application list and select **Settings** → **Wireless & networks** → **VPN settings** → **Add VPN**.
- 2 Select a VPN type.
- 3 Customise the connection information.



Available options may vary depending on the VPN type.

Option	Function
VPN name	Enter a name of the VPN server.
Set VPN server	Enter the IP address of the VPN server.
Enable encryption	Set to encrypt the VPN server.
Set IPsec pre-shared key	Enter a pre-shared key.
Enable L2TP secret	Set to use the L2TP secret password.

Option	Function
Set L2TP secret	Enter the L2TP secret password.
Set user certificate	Select a user certificate that the VPN server uses to identify you. You can import certificates from the VPN server or download from the web.
Set CA certificate	Select a certificate authority (CA) certificate that the VPN server uses to identify you. You can import certificates from the VPN server or download from the web.
DNS search domains	Enter the domain name server (DNS) address.

4 When you are finished, select  → **Save**.

## › Connect to a private network

- 1 From the Home screen, open the application list and select **Settings** → **Wireless & networks** → **VPN settings**.
- 2 Select a private network to connect.
- 3 Enter the user name and password and select **Connect**.



# Tools

## Calculator

Learn to perform mathematical calculations directly on your device like a typical hand-held or desktop calculator.

- 1 From the Home screen, open the application list and select **Calculator**.
- 2 Use the keys that correspond to the calculator display to perform a basic or scientific calculator.

## Clock

Learn to set and control alarms for important events.

### › Set a new alarm

- 1 From the Home screen, open the application list and select **Clock**.
- 2 Select **Set alarm** → **Add alarm**.
- 3 Set alarm details.
- 4 When you are finished, select **Done** → **Done**.

### › Stop an alarm

When the alarm sounds,

- To stop the alarm, select **Dismiss**.
- To repeat the alarm after a specified length of time, select **Snooze**.

## › Delete an alarm

- 1 From the Home screen, open the application list and select **Clock**.
- 2 Select **Set alarm**.
- 3 Select an alarm to delete.
- 4 Select **Delete** → **OK**.



You can deactivate an alarms by clearing the check box next to the time.

## Downloads

Learn to manage logs of files you have downloaded from the web and email.

- 1 From the Home screen, open the application list and select **Downloads**.
- 2 Select a download folder.
- 3 To open a downloaded file, select the log.  
To delete a log, select the check box and then select **Delete**.

## Voice Search

Learn to use the voice command feature to dial a number, send a message, or search for locations and information by voice.



This feature may be unavailable depending on your region or service provider.











- 1 From the Home screen, open the application list and select **Voice Search**.
- 2 If you are launching this application for the first time, select **Yes**.



- 3 Select **Speak now**.
- 4 Say a command into the microphone and select **OK**.

## Quickoffice



Learn to create or view Microsoft Word, Excel, PowerPoint, and Adobe PDF files on your device.

### › Create a Quickoffice document

- 1 From the Home screen, open the application list and select **Quickoffice**.  
If you are launching this application for the first time, register as an online user or skip the registration.
- 2 Select  → a document type.
- 3 While entering contents in the document, use the following options:
  - To undo your last action, select .
  - To insert an image file from the Gallery or create a new photo, select .
  - To search for text in the document, select .
  - To insert a new cell, select .
  - To insert a new slide, select .
  - To start a slideshow, select .
  - To display a keypad on the screen, select .
  - To customise the settings for fonts, select .
  - To use the text-to-speech feature, select .

- 4 When you are finished, select  → **Save**.
- 5 Enter a name for the document and select a location to save the document.
- 6 Select .

## › Open a document

- 1 From the Home screen, open the application list and select **Quickoffice**.
- 2 Select **Local Files** or **Recent Documents** → a document file.
  - To send the document to others, select  → **Send**.
  - To view document details, select  → **Properties**.

## › Upload a document to a server

You can upload your data on a server using the cloud computing service.

- 1 From the Home screen, open the application list and select **Quickoffice**.
- 2 Select  → a website.
- 3 Select **Continue** to confirm.
- 4 Enter your email address and password and select **OK**.  
A remote account will be added on the left pane of the screen.
- 5 Select **Local Files** and drag it to the account you added.
- 6 Select an option to copy or move the file.

# Settings

## Access the Settings menu

- 1 From the Home screen, open the application list and select **Settings**.
- 2 Select a setting category and select an option.

## Wireless & networks

Change the settings for wireless network connections.

### › Flight mode

Disable all wireless functions on your device. You can use only non-network services.

### › Wi-Fi

Turn the WLAN feature on or off.

### › Wi-Fi settings

- **Wi-Fi:** Turn the WLAN feature on or off. ► p. 66
- **Network notification:** Set the device to notify you when an open network is available.
- **Wi-Fi disconnect policy:** Set when the device will turn off the WLAN feature.
- **Add Wi-Fi network:** Add WLAN APs manually.

### › Bluetooth

Turn the Bluetooth wireless feature on or off.

## › Bluetooth settings

- **Bluetooth:** Turn the Bluetooth wireless feature on or off.  
▶ p. 68
- **Device name:** Set a Bluetooth name for your device.
- **Discoverable:** Set your device to be visible to other Bluetooth devices.
- **Show received files:** View files received from other devices via the Bluetooth wireless feature.
- **Find nearby devices:** Search for available Bluetooth devices.

## › VPN settings

Set up and connect to virtual private networks (VPNs). ▶ p. 71

## Sound

Change the settings for various sounds on your device.

- **Vibrate:** Set when the device will vibrate for various events.
- **Volume:** Adjust the volume level for alarm ringtones, system sounds, and notifications.
- **Notification ringtone:** Select a ringtone to alert you to events.
- **Audible selection:** Set the device to sound when you select an application or option on the touch screen.
- **Screen lock sounds:** Set the device to sound when you lock or unlock the touch screen.
- **Haptic feedback:** Set the device to vibrate when you touch the keys.

## Screen

Change the settings for the display.

- **Brightness:** Set the brightness of the display.
- **Auto-rotate screen:** Set whether or not to rotate the content automatically when the device is rotated.
- **Animation:** Set the device to display animation when you switch between windows.
- **Timeout:** Set the length of time the device waits before turning off the display's backlight.
- **Auto adjust screen power:** Set to save power by adjusting the brightness of the display.

## Location & security

Change the settings for securing your device and GPS functionality.

- **Use wireless networks:** Set to use WLAN for finding your location.
- **Use GPS satellites:** Set to use the GPS satellite for finding your location.
- **Use location for Google Search:** Set the device to use your current location for Google search and other Google services.
- **Configure lock screen:** Set the unlock security code.
  - **Off:** Disable the screen lock.
  - **Unsecure:** Set a default unlock pattern to unlock the screen.
  - **Pattern:** Set an unlock pattern to unlock the screen.
  - **PIN:** Set a PIN (numeric) to unlock the screen.
  - **Password:** Set a password (alphanumeric) to unlock the screen.
- **Owner information:** Edit the text you want to display on the screen when you turn on the device.

- **Encrypt tablet:** Set a PIN or a password to encrypt the device to protect data and information saved on the device. Once the device is encrypted, you must enter the password each time you turn on the device. You must first charge the battery because it may take more than an hour to encrypt your device.
- **Visible passwords:** Set the device to display your password as you enter.
- **Device administrators:** View device administrators installed on your device. You can activate device administrators to apply new policies to your device.
- **Use secure credentials:** Use certificates and credentials to ensure secure use of various applications.
- **Install encrypted certificates from SD card:** Install encrypted certificates that are stored in the USB storage.
- **Set password:** Create and confirm a password for accessing credentials.
- **Clear credentials:** Erase the credential contents from the device and reset the password.

## Applications

Change the settings for managing installed applications.

- **Manage applications:** Access the list of the applications installed on the device and check the application information.
- **Running services:** View the services you are using and access them to manage.
- **Memory use:** View available memory and the memory used by applications.
- **Battery use:** View the amount of power consumed by open applications.



- **Unknown sources:** Select to download applications from any source. If you do not select this option, you can download applications only from Android Market.
- **Development:**
  - **USB debugging:** Select to connect your device to a PC by using a PC data cable. This is for application development.
  - **Stay awake:** Set the device's screen to stay on while charging the battery.
  - **Allow mock locations:** Allow mock locations and service information to be sent to a Location Manager service for testing. This is for application development.
- **Samsung Apps:** Set to receive notifications for new applications from Samsung Apps.

## Accounts & sync

Change the settings for the auto sync feature or manage accounts for synchronisation.

- **Background data:** Select this setting to use the auto sync feature. The auto sync will run in the background without opening applications and synchronise data.
- **Auto-sync:** Set the device to synchronise contact, calendar, and email data automatically.

## Privacy

- **Back up my data:** Set to back up your settings and application data to the Google server.
- **Backup account:** Add and view your Google account to back up your data.

- **Automatic restore:** Set to restore your settings and application data when the applications are reinstalled on your device.
- **Factory data reset:** Reset your settings to the factory default values and delete all your data.

## Storage

Check memory information of your device.

## Language & input

Change the settings for text input, the voice recogniser, and the text-to-speech feature.

- **Select language:** Select a display language for all menus and applications.
- **User dictionary:** Set up your own dictionary. The words in your dictionary will appear as word suggestions for your text inputs.
- **Voice recognition settings:**
  - **Language:** Select a language for the Google voice recognition.
  - **SafeSearch:** Set the device to filter explicit text and/or images from voice search results.
  - **Block offensive words:** Hide offensive words your device recognised from voice search results.
- **Text-to-speech settings:**
  - **Listen to example:** Listen to the spoken text for an example. Install voice data for using the text-to-speech feature.
  - **Always use my settings:** Set the device to use the settings you specify in applications rather than the default settings.

- **Default engine:** Set the speech synthesis engine to be used for spoken text.
- **Install voice data:** Download and install voice data for the text-to-speech feature.
- **Speech rate:** Select a speed for the text-to-speech feature.
- **Language:** Select a language for the text-to-speech feature.
- **Engines:** View the text-to-speech engines downloaded from Android Market.
- **Current input method:** View a default keyboard type for text input.
- **Input method selector:** Set the device to hide or display the text input settings icon (  ). If you select **Automatic**, your device will automatically hide or display the icon, based on the keyboard.
- **Configure input methods:**
  - **Android keyboard:** Set the device to use the Android keyboard.
  - **Active input methods:** Select languages to be used for text input.
  - **Settings:**
    - Auto-capitalisation:** Set the device to automatically capitalise the first letter after a final punctuation mark, such as a full stop, question mark, or exclamation mark.
    - Vibrate on key-press:** Set the device to vibrate when you touch a key.
    - Sound on key-press:** Set the device to sound when you touch a key.
    - Auto-correction:** Set the device to automatically correct the misspelled words.
    - Show correction suggestions:** Set the device to predict words according to your input and display word suggestions.

## Accessibility

Change the settings for accessibility features.

- **Accessibility:** Activate an accessibility application you have downloaded, such as Talkback or Kickback, which provide voice, melody, or vibration feedback.
- **Accessibility applications:** Select an accessibility application to use. This option is available only when you downloaded accessibility applications on your device.
- **Download accessibility scripts:** Set to allow downloading of accessibility scripts from Google.

## Date & time

Access and alter the following settings to control how time and date are displayed on your device:

- **Set date:** Set the current date manually.
- **Set time:** Set the current time manually.
- **Select time zone:** Set your home time zone.
- **Use 24-hour format:** Set to the time to be displayed in 24-hour format.
- **Select date format:** Select a date format.

## About tablet

Access information about your device, check the device's status, and update the device system.

# Troubleshooting

## Your device displays network or service error messages

- When you are in areas with weak signals or poor reception, you may lose reception. Move to another area and try again.
- You cannot access some options without a subscription. Contact your service provider for more details.

## The touch screen responds slowly or improperly

If your device has a touch screen and the touch screen is not responding properly, try the following:

- Remove any protective covers from the touch screen. Protective covers may prevent the device from recognising your inputs and are not recommended for touch screen devices.
- Ensure that your hands are clean and dry when tapping the touch screen.
- Restart your device to clear any temporary software bugs.
- Ensure that your device software is upgraded to the latest version.
- If the touch screen is scratched or damaged, take it to your local Samsung Service Centre.

## Your device freezes or has fatal errors

If your device freezes or hangs, you may need to close programs or reset the device to regain functionality. If your device is frozen and unresponsive, press and hold [⏻] for 8-10 seconds. The device will reboot automatically.

If this does not solve the problem, perform a factory data reset. From the Home screen, open the application list and select **Settings** → **Privacy** → **Factory data reset** → **Reset tablet** → **Delete all**.

## **The device beeps and the battery icon flashes**

Your battery is low. Recharge the battery to continue using the device.

## **The battery does not charge properly or the device turns off**

If the battery will no longer charge completely, you need to replace it with a new battery. Take your device to your local Samsung Service Centre.

## **Your device is hot to the touch**

When you use applications that require more power or use applications on your device for an extended period of time, your device may feel hot to the touch. This is normal and should not affect your device's lifespan or performance.

## **Error messages appear when launching the camera**

Your Samsung mobile device must have sufficient available memory and battery power to operate the camera application. If you receive error messages when launching the camera, try the following:

- Charge the battery.
- Free some memory by transferring files to a PC or deleting files from your device.
- Restart the device. If you are still having trouble with the camera application after trying these tips, contact a Samsung Service Centre.

## **Error messages appear when opening music files**

Some music files may not play on your Samsung mobile device for a variety of reasons. If you receive error messages when opening music files on your device, try the following:

- Free some memory by transferring files to a PC or deleting files from your device.
- Ensure that the music file is not Digital Rights Management (DRM)-protected. If the file is DRM-protected, ensure that you have the appropriate license or key to play the file.
- Ensure that your device supports the file type.

## **Another Bluetooth device is not located**

- Ensure that the Bluetooth wireless feature is activated on your device.
- Ensure that the Bluetooth wireless feature is activated on the device you wish to connect to, if necessary.
- Ensure that your device and the other Bluetooth device are within the maximum Bluetooth range (10 m).

If the tips above do not solve the problem, contact a Samsung Service Centre.

## **A connection is not established when you connect the device to a PC**

- Ensure that the PC data cable you are using is compatible with your device.
- Ensure that you have the proper drivers installed and updated on your PC.

# Safety precautions

To prevent injury to yourself and others or damage to your device, read all of the following information before using your device.

## Warning: Prevent electric shock, fire, and explosion

**Do not use damaged power cords or plugs, or loose electrical sockets**

**Do not touch the power cord with wet hands, or disconnect the charger by pulling on the cord**

**Do not bend or damage the power cord**

**Do not use your device while charging or touch your device with wet hands**

**Do not short-circuit the charger or the battery**

**Do not drop or cause an impact to the charger or the battery**

**Do not charge the battery with chargers that are not approved by the manufacturer**

**Do not use your device during a thunderstorm**

Your device may malfunction and your risk of electric shock is increased.

**Do not handle a damaged or leaking Lithium Ion (Li-Ion) battery**

For safe disposal of your Li-Ion batteries, contact your nearest authorised service centre.

**Handle and dispose of batteries and chargers with care**

- Use only Samsung-approved batteries and chargers specifically designed for your device. Incompatible batteries and chargers can cause serious injuries or damage to your device.
- Never dispose of batteries or devices in a fire. Follow all local regulations when disposing of used batteries or devices.



- Never place batteries or devices on or in heating devices, such as microwave ovens, stoves, or radiators. Batteries may explode when overheated.
- Never crush or puncture the battery. Avoid exposing the battery to high external pressure, which can lead to an internal short circuit and overheating.

### **Protect the device, batteries, and chargers from damage**

- Avoid exposing your device and batteries to very cold or very hot temperatures.
- Extreme temperatures can cause the deformation of the device and reduce the charging capacity and life of your device and batteries.
- Prevent batteries from contacting metal objects, as this can create a connection between the + and – terminals of your batteries and lead to temporary or permanent battery damage.
- Never use a damaged charger or battery.

## **Caution: Follow all safety warnings and regulations when using your device in restricted areas**

### **Turn off your device where prohibited**

Comply with all regulations that restrict the use of a mobile device in a particular area.

### **Do not use your device near other electronic devices**

Most electronic devices use radio frequency signals. Your device may interfere with other electronic devices.

### **Do not use your device near a pacemaker**

- Avoid using your device within a 15 cm range of a pacemaker if possible, as your device can interfere with the pacemaker.
- If you must use your device, keep at least 15 cm away from the pacemaker.
- To minimise the possible interference with a pacemaker, use your device on the opposite side of your body from the pacemaker.

### **Do not use your device in a hospital or near medical equipment that can be interfered with by radio frequency**

If you personally use any medical equipment, contact the manufacturer of the equipment to ensure the safety of your equipment from radio frequency.

## **If you are using a hearing aid, contact the manufacturer for information about radio interference**

Some hearing aids may be interfered with by the radio frequency of your device. Contact the manufacturer to ensure the safety of your hearing aid.

## **Turn off the device in potentially explosive environments**

- Always comply with regulations, instructions and signs in potentially explosive environments.
- Do not use your device at refuelling points (service stations), near fuels or chemicals, and at blasting areas.
- Do not store or carry flammable liquids, gases, or explosive materials in the same compartment as the device, its parts, or accessories.

## **Turn off your device when in an aircraft**

Using your device in an aircraft is illegal. Your device may interfere with the electronic navigation instruments of the aircraft.

## **Electronic devices in a motor vehicle may malfunction due to the radio frequency of your device**

Electronic devices in your car may malfunction due to radio frequency of your device. Contact the manufacturer for more information.

# **Proper care and use of your mobile device**

## **Keep your device dry**

- Humidity and all types of liquids may damage device parts or electronic circuits.
- When wet, turn off your device. Dry your device with a towel and take it to a service centre.
- Liquids will change the colour of the label that indicates water damage inside the device. Water damage to your device can void your manufacturer's warranty.

## **Do not use or store your device in dusty, dirty areas**

Dust can cause your device to malfunction.

## **Do not store your device on slopes**

If your device falls, it can be damaged.

## **Do not store your device in hot or cold areas. Use your device at -20 °C to 45 °C**

- Your device can explode if left inside a closed vehicle, as the inside temperature can reach up to 80 °C.
- Do not expose your device to direct sunlight for extended periods of time (such as on the dashboard of a car).
- Store the battery at -20 °C to 45 °C.

## **Do not store your device with such metal objects as coins, keys and necklaces**

- Your device may become deformed or malfunction.
- If the battery terminals are in contact with metal objects, it may cause a fire.

## **Do not store your device near magnetic fields**

- Your device may malfunction or the battery may discharge from exposure to magnetic fields.
- Magnetic stripe cards, including credit cards, phone cards, passbooks, and boarding passes, may be damaged by magnetic fields.
- Do not use carrying cases or accessories with magnetic closures or allow your device to come in contact with magnetic fields for extended periods of time.

## **Do not store your device near or in heaters, microwaves, hot cooking equipment, or high pressure containers**

- The battery may leak.
- Your device may overheat and cause a fire.

## **Do not drop your device or cause impacts to your device**

- The screen of your device may be damaged.
- If bent or deformed, your device may be damaged or parts may malfunction.

## **Do not use a flash close to the eyes of people or animals**

Using a flash close to the eyes may cause temporary loss of vision or damage to the eyes.

## **Ensure maximum battery and charger life**

- Avoid charging batteries for more than a week, as overcharging may shorten battery life.
- Over time, unused batteries will discharge and must be recharged before use.
- Disconnect chargers from power sources when not in use.
- Use batteries only for their intended purposes.

## **Use manufacturer-approved batteries, chargers, accessories and supplies**

- Using generic batteries or chargers may shorten the life of your device or cause the device to malfunction.
- Samsung cannot be responsible for the user's safety when using accessories or supplies that are not approved by Samsung.

## **Do not bite or suck on the device or the battery**

- Doing so may damage the device or cause explosion.
- If children use the device, make sure that they use the device properly.

## **When using the device:**

- Speak directly into the mouthpiece.
- Avoid contact with your device's internal antenna. Touching the antenna may cause the device to transmit more radio frequency than necessary.
- Hold the device with a relaxed grip, press the keys lightly, use special features that reduce the number of keys you have to press (such as predictive text), and take frequent breaks.

## **Protect your hearing**



- Excessive exposure to loud sounds can cause hearing damage.
- Exposure to loud sounds while driving may distract your attention and cause an accident.
- Always turn the volume down before plugging the earphones into an audio source and use only the minimum volume setting necessary to hear your conversation or music.

## **Use caution when using the device while walking or moving**

Always be aware of your surroundings to avoid injury to yourself or others.

## **Do not carry your device in your back pockets or around your waist**

You can be injured or damage the device if you fall.

## **Do not disassemble, modify, or repair your device**

- Any changes or modifications to your device can void your manufacturer's warranty. For service, take your device to a Samsung Service Centre.
- Do not disassemble or puncture the battery, as this can cause explosion or fire.

## **Do not paint or put stickers on your device**

Paint and stickers can clog moving parts and prevent proper operation. If you are allergic to paint or metal parts of the product, you may experience itching, eczema, or swelling of the skin. When this happens, stop using the product and consult your physician.

## **When cleaning your device:**

- Wipe your device or charger with a towel or a rubber.
- Do not use chemicals or detergents.

## **Do not use the device if the screen is cracked or broken**

Broken glass or acrylic could cause injury to your hands and face. Take the device to a Samsung Service Centre to have it repaired.

## **Do not use the device for anything other than its intended use**

## **Avoid disturbing others when using the device in public**

## **Do not allow children to use your device**

Your device is not a toy. Do not allow children to play with it as they could hurt themselves and others, or damage the device.

## **Install mobile devices and equipment with caution**

- Ensure that any mobile devices or related equipment installed in your vehicle are securely mounted.
- Avoid placing your device and accessories near or in an air bag deployment area. Improperly installed wireless equipment can cause serious injury when air bags inflate rapidly.

## **Allow only qualified personnel to service your device**

Allowing unqualified personnel to service your device may result in damage to your device and will void your manufacturer's warranty.

## **Be sure to back up important data**

Samsung is not responsible for data loss.

## **Do not distribute copyright-protected material**

Do not distribute copyright-protected material that you have recorded to others without the permission of the content owners. Doing this may violate copyright laws. The manufacturer is not liable for any legal issues caused by the user's illegal use of copyrighted material.

## Specific Absorption Rate (SAR) certification information

Your device conforms to European Union (EU) standards that limit human exposure to radio frequency (RF) energy emitted by radio and telecommunications equipment. These standards prevent the sale of mobile devices that exceed a maximum exposure level (known as the Specific Absorption Rate, or SAR) of 2.0 W/kg.

During testing, the maximum SAR recorded for this model was 0.164 W/kg. In normal use, the actual SAR is likely to be much lower, as the device has been designed to emit only the RF energy necessary to transmit a signal to the nearest base station. By automatically emitting lower levels when possible, your device reduces your overall exposure to RF energy.

The Declaration of Conformity statement at the back of this manual demonstrates your device's compliance with the European Radio & Terminal Telecommunications Equipment (R&TTE) directive.



When carrying the product or using it while worn on the body maintain a distance of 5 mm from the body to ensure compliance with RF exposure requirements.

## Correct disposal of this product



(Waste Electrical & Electronic Equipment)

(Applicable in the European Union and other European countries with separate collection systems)

This marking on the product, accessories or literature indicates that the product and its electronic accessories (e.g. charger, headset, USB cable) should not be disposed of with other household waste at the end of their working life.

To prevent possible harm to the environment or human health from uncontrolled waste disposal, please separate these items from other types of waste and recycle them responsibly to promote the sustainable reuse of material resources.

Household users should contact either the retailer where they purchased this product, or their local government office, for details of where and how they can take these items for environmentally safe recycling.

Business users should contact their supplier and check the terms and conditions of the purchase contract. This product and its electronic accessories should not be mixed with other commercial wastes for disposal.

This EEE is compliant with RoHS.

## Correct disposal of batteries in this product



(Applicable in the European Union and other European countries with separate battery return systems)

This marking on the battery, manual or packaging indicates that the batteries in this product should not be disposed of with other household waste at the end of their working life.

Where marked, the chemical symbols Hg, Cd or Pb indicate that the battery contains mercury, cadmium or lead above the reference levels in EC Directive 2006/66. If batteries are not properly disposed of, these substances can cause harm to human health or the environment.

To protect natural resources and to promote material reuse, please separate batteries from other types of waste and recycle them through your local, free battery return system.

The rechargeable battery incorporated in this product is not user replaceable. For information on its replacement, please contact your service provider.

## Disclaimer

Some content and services accessible through this device belong to third parties and are protected by copyright, patent, trademark and/or other intellectual property laws. Such content and services are provided solely for your personal noncommercial use. You may not use any content or services in a manner that has not been authorised by the content owner or service provider. Without limiting the foregoing, unless expressly authorised by the applicable content owner or service provider, you may not modify, copy, republish, upload, post, transmit, translate, sell, create derivative works, exploit, or distribute in any manner or medium any content or services displayed through this device.

“THIRD PARTY CONTENT AND SERVICES ARE PROVIDED “AS IS.” SAMSUNG DOES NOT WARRANT CONTENT OR SERVICES SO PROVIDED, EITHER EXPRESSLY OR IMPLIEDLY, FOR ANY PURPOSE. SAMSUNG EXPRESSLY DISCLAIMS ANY IMPLIED WARRANTIES, INCLUDING BUT NOT LIMITED TO, WARRANTIES OF MERCHANTABILITY OR FITNESS FOR A PARTICULAR PURPOSE. SAMSUNG DOES NOT GUARANTEE THE ACCURACY, VALIDITY, TIMELINESS, LEGALITY, OR COMPLETENESS OF ANY CONTENT OR SERVICE MADE AVAILABLE THROUGH THIS DEVICE AND UNDER NO CIRCUMSTANCES, INCLUDING NEGLIGENCE, SHALL SAMSUNG BE LIABLE, WHETHER IN CONTRACT OR TORT, FOR ANY DIRECT, INDIRECT, INCIDENTAL, SPECIAL OR CONSEQUENTIAL DAMAGES, ATTORNEY FEES, EXPENSES, OR ANY OTHER DAMAGES ARISING OUT OF, OR IN CONNECTION WITH, ANY INFORMATION CONTAINED IN, OR AS A RESULT OF THE USE OF ANY CONTENT OR SERVICE BY YOU OR ANY THIRD PARTY, EVEN IF ADVISED OF THE POSSIBILITY OF SUCH DAMAGES.”

Third party services may be terminated or interrupted at any time, and Samsung makes no representation or warranty that any content or service will remain available for any period of time. Content and services are transmitted by third parties by means of networks and transmission facilities over which Samsung has no control. Without limiting the generality of this disclaimer, Samsung expressly disclaims any responsibility or liability for any interruption or suspension of any content or service made available through this device. Samsung is neither responsible nor liable for customer service related to the content and services. Any question or request for service relating to the content or services should be made directly to the respective content and service providers.



# Index

## alarms

- creating 73
- deactivating 74
- stopping 73

## application list

- accessing 20

## battery

- charging 9

## Bluetooth

- activating 68
- finding and pairing with devices 68
- receiving data 69
- sending data 69

## brightness, display 22

## calendar

- creating events 62
- viewing events 63

## camera

- capturing photos 49
- customising camcorder 56
- customising camera 53
- recording videos 54

## connections

- Bluetooth 67
- PC 64
- WLAN 66

## contacts 60

- creating 60
- retrieving 60

## device

- customising 20
- indicator icons 14
- keys 13
- layout 12
- settings 77
- shortcuts panel 19
- turning on or off 11

## download manager 74

## email

- sending 42
- viewing 43

## flight mode 11

## gallery

- playing videos 58
- viewing photos 57

## Google Mail 39

## Google Maps 34

## Google Talk 44

## home screen

- adding items 18
- moving items 18
- removing items 18

## internet

- see web browser

## language 82

## market 32

## messages

- sending email 42
- setting email accounts 41

- movie studio 58
- music player
  - adding files 46
  - creating playlists 47
  - playing music 47
- PC connections
  - mass storage 65
  - Samsung Kies 64
  - Windows Media Player 65
- phonebook
  - creating contacts 60
  - finding contacts 61
- photos
  - capturing 49
  - capturing by scene 51
  - viewing 57
- Pulse 31
- Quickoffice 75
- Samsung Apps 38
- Samsung Kies 64
- settings
  - about tablet 84
  - accessibility 84
  - accounts & sync 81
  - applications 80
  - date & time 84
  - language & input 82
  - location & security 79
  - privacy 81
  - screen 79
  - sound 78
  - storage 82
  - wireless & networks 77
- silent mode 21
- text input 24
- time and date, set 20
- touch screen
  - locking 16
  - using 15
- unpack 8
- video player 58
- videos
  - capturing 54
  - making 58
  - playing 58
- voice search 74
- VPN connections
  - connecting to 72
  - creating 71
- web browser
  - adding bookmarks 29
  - browsing web pages 26
  - opening multiple pages 29
  - searching for information by voice 28
- WLAN
  - activating 66
  - finding and connecting to networks 66
- YouTube 33
  - uploading videos 34
  - watching videos 33

## Declaration of Conformity (R&TTE)

We, **Samsung Electronics**  
declare under our sole responsibility that the product

### Portable Bluetooth/Wi-Fi Device : GT-P7510

to which this declaration relates, is in conformity with the following standards and/or other normative documents.

SAFETY	EN 60950-1 : 2006 +A11 : 2009
SAR	EN 62209-2 : 2010 EN 62311 : 2008 EN 50371 : 2002 Council Recommendation 1999/519/EC
EMC	EN 301 489-01 V1.8.1 (04-2008) EN 301 489-17 V2.1.1 (05-2009) EN 301 489-19 V1.2.1 (11-2002) EN 55022 : 2006 + A1 : 2007 EN 55024 : 1998 + A1 : 2001 + A2 : 2003
RADIO	EN 300 328 V1.7.1 (10-2006) EN 300 440-1 V1.5.1 (03-2009) EN 300 440-2 V1.3.1 (03-2009) EN 301 893 V1.5.1 (12-2008)

We hereby declare that [all essential radio test suites have been carried out and that] the above named product is in conformity to all the essential requirements of Directive 1999/5/EC.

The conformity assessment procedure referred to in Article 10 and detailed in Annex[IV] of Directive 1999/5/EC has been followed with the involvement of the following Notified Body(ies):

BABT, Forsyth House,  
Churchfield Road,  
Walton-on-Thames,  
Surrey, KT12 2TD, UK\*  
Identification mark: 0168



The technical documentation kept at :

Samsung Electronics QA Lab.

which will be made available upon request.  
(Representative in the EU)

Samsung Electronics Euro QA Lab.  
Blackbushe Business Park, Saxony Way,  
Yateley, Hampshire, GU46 6GG, UK\*



2011. 04. 14

Joong-Hoon Choi / Lab Manager

(place and date of issue)

(name and signature of authorised person)

\* It is not the address of Samsung Service Centre. For the address or the phone number of Samsung Service Centre, see the warranty card or contact the retailer where you purchased your product.

Some of the contents in this manual may differ from your device depending on the software of the device or your service provider.

### **To install Kies (PC Sync) Kies**

1. Download the latest version of Kies from the Samsung website ([www.samsung.com/kies](http://www.samsung.com/kies)) and install it on your PC.
2. Using a PC data cable, connect your device to your PC. Samsung Kies will launch automatically. Refer to the Kies help for more information.