

OWNER'S MANUAL



Reverse Osmosis System

MODEL NO. 625.381560

UltraFilter 450

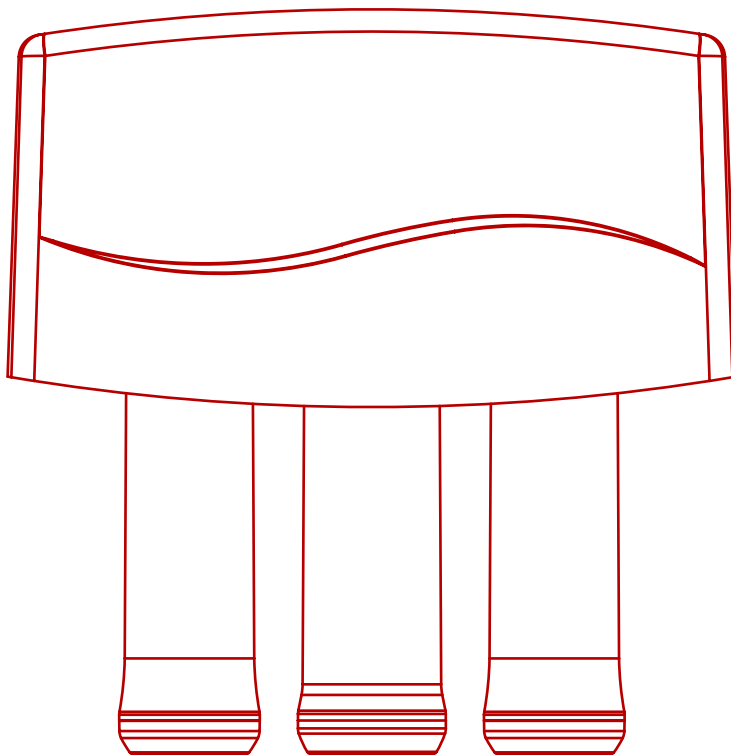

Caution:

Read and follow all safety rules and operating instructions before first use of this product.

Questions ?

Visit www.KenmoreWater.com

or call toll free 1-800-426-9345 (M - F, 7AM - 8 PM CST)

Repair or Parts ? Call toll free 1-800-366-7278

See back cover for other Sears service numbers.

SAVE THIS MANUAL

- Warranty
- Installation
- How It Works
- Care Of
- Specifications
- Repair Parts

System Tested and Certified by NSF International against NSF/ANSI Standard 42 and 58. See performance data sheet for details.

Sears, Roebuck and Co., 3333 Beverly Road, Hoffman Estates, IL 60179 USA

ONE YEAR FULL WARRANTY ON REVERSE OSMOSIS SYSTEM

When installed, operated and maintained according to all instructions supplied with the product, if this Reverse Osmosis System fails due to a defect in material or workmanship within one year from the date of purchase, call 1-800-4-MY-HOME to arrange for free repair (or replacement if repair proves impossible). This warranty does not include filter cartridges or the Reverse Osmosis membrane, which are expendable items.

This warranty applies only while this product is in use in the United States.

This warranty gives you specific legal rights, and you may have other rights which vary from state to state.

Sears, Roebuck and Co., Hoffman Estates, IL 60179

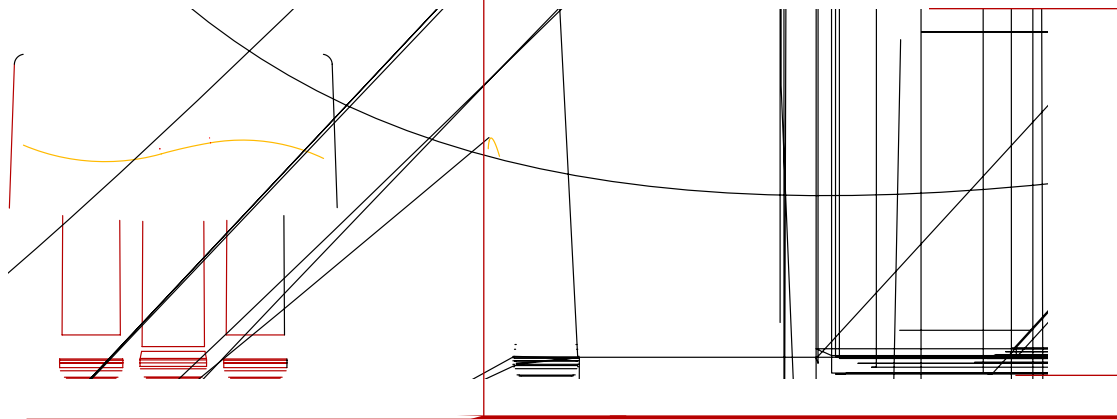

Questions? Call The Kenmore Water Line 1-800-426-9345 or visit KenmoreWater.com

Table of Contents

Unpack and Check Shipment	4
What Your Reverse Osmosis System Will do	5
Plan Your Installation	5-6
Overview and Site Preparation	7
Step 1-Install Supply Water Fitting	8
Step 2-Install Reverse Osmosis Drain	9-10
Step 3-Install Reverse Osmosis Filter Assembly	11
Step 4-Install Storage Tank	11
Step 5-Install Reverse Osmosis Faucet	12-13
Step 6-Connect Tubes	14-15
Step 7-Sanitize, Pressure Test, Purge System	16-17
How Your Reverse Osmosis Water System Works	18-19
Maintenance	20-21
Specifications	22
Troubleshooting	24-25
Exploded View & Parts List	26-27

Safety Guides

- ▼ Read all steps and guides carefully before installing and using your reverse osmosis system. Follow all steps exactly to correctly install. Reading this manual will also help you to get all the benefits from the reverse osmosis system.
- ▼ Do not attempt to use this product to make safe drinking water from non-potable water sources. Do not use the system on microbiologically unsafe water, or water of unknown quality without adequate disinfection before or after the system. This system is certified for cyst reduction and may be used on disinfected water that may contain filterable cysts.
- ▼ Check with your local public works department for plumbing and sanitation codes. You must follow their guides as you install the system. Follow your local codes if they differ with guides in this manual.
- ▼ This system shall only be used for arsenic reduction on chlorinated water supplies containing detectable residual free chlorine at the system inlet. Water systems using an inline chlorinator should provide a one minute chlorine contact time before the RO system.
- ▼ This system is acceptable for treatment of influent concentrations of no more than 27 mg/L nitrate and 3 mg/L nitrite in combination measured as N and is certified for nitrate/nitrite reduction only for water supplies with a pressure of 280 kPa (40 psig) or greater.
- ▼ The reverse osmosis system works on water pressures of 40 psi (minimum) to 100 psi (maximum). If your house water pressure is over the maximum, install a pressure reducing valve in the water supply pipe to the reverse osmosis system.
- ▼ Do not install the reverse osmosis system outside, or in extreme hot or cold temperatures. Temperature of the water supply to the reverse osmosis system must be between 40°F and 100°F. Do not install on hot water.
- ▼ Read the other limits (pH, hardness, etc.) in the specifications and be sure your water supply conforms.
- ▼ The reverse osmosis membrane contains a preservative for storage and shipment. Be sure to purge as instructed on page 17 before using product water.

Questions? Call The Kenmore Water Line 1-800-426-9345 or visit KenmoreWater.com

Unpack and Check Your Carton

INSPECT SHIPMENT

Your Reverse Osmosis Drinking Water System is shipped complete in one carton. Remove all items from your shipping carton.

Check all items against the packing list below. Note any items lost or damaged in shipment. Note any damage to the shipping carton. Refer to the exploded view and parts list in the back of the manual for the part names and numbers of missing or damaged items. If problems exist, refer to the website or the toll free number listed throughout this manual.

Keep the small parts in the parts bag until you are ready to install them.

NOTE: Codes in the state of Massachusetts require installation by a licensed plumber and do not permit the use of saddle valves.

If you live in the state of Massachusetts, review plumbing code 248-CMR of the Commonwealth of Massachusetts before proceeding with the installation.

Packing List

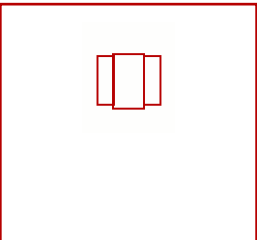
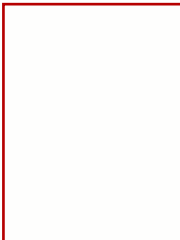
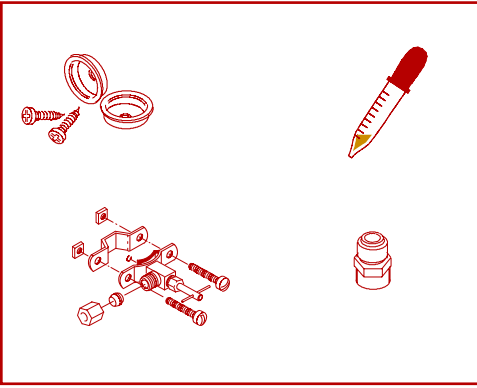
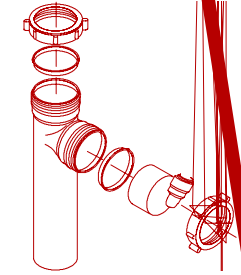
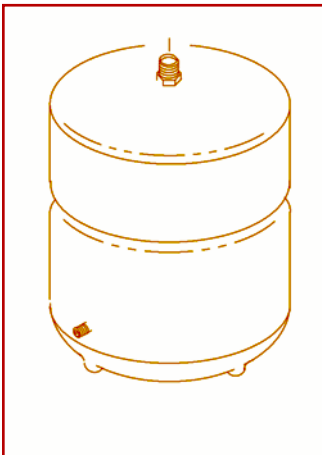
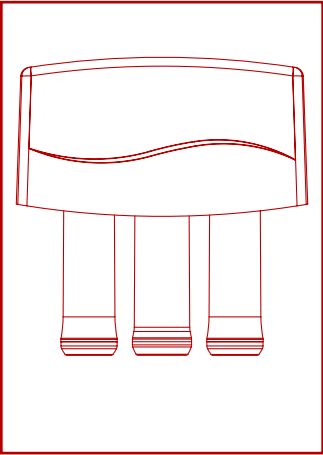

Questions? Call The Kenmore Water Line 1-800-426-9345 or visit KenmoreWater.com

What Your Reverse Osmosis System Will Do

Your Reverse Osmosis (RO) Drinking Water System is a water treatment unit. It uses household water pressure to reverse a natural physical process called osmosis. Water, under pressure, is forced through a semi-permeable membrane where minerals and impurities are filtered out. Clean drinking water goes to the faucet or storage, while minerals and impurities are sent to the drain with RO waste water. The minerals and impurities are measured in water as total dissolved solids (TDS).

The system includes replaceable pre and postfilter sediment-carbon cartridges. The prefilter reduces sand, silt, dirt, rust particles, other sediments, and chlorine from the water supply before it can enter the RO membrane.

The postfilter reduces any tastes and/or odors that may remain in the water, after passing through the RO membrane, and just before going to the RO faucet. To prevent water waste, an automatic shutoff valve closes when the RO faucet is closed and the storage tank is full.

Your reverse osmosis system gives you a continuous supply of sparkling clear, delicious water for drinking, cooking and other uses. Foods will look and taste better too. Having high quality RO product water at your fingertips eliminates the need to buy bottled water. The storage tank holds over 2 gallons of RO product water for your needs.

Plan Your Installation

PLAN YOUR INSTALLATION

It is recommended to read through the entire manual before beginning your installation. Follow all steps exactly. Reading this manual will also help you get all the benefits from your system.

Your Reverse Osmosis Drinking Water System can be installed under a sink or in a remote location. Typical remote sites are a laundry room or utility room. Review the location options below and determine where you are going to install your system.

UNDER THE SINK LOCATION

The Reverse Osmosis Filter Assembly and storage tank are normally installed in a kitchen or bathroom sink cabinet. See Figure 2.

A suitable drain point is needed for reject water from the Reverse Osmosis filter.

REMOTE LOCATION

You can also locate the Reverse Osmosis Filter Assembly and storage tank in a remote location away from the Reverse Osmosis Faucet. You will need a nearby water source and drain point.

See Figure 3.

CHECK SPACE REQUIREMENTS

Check size and position of items for proper installation into location chosen.

TOOLS NEEDED

Review the tools needed list. See Figure 1. Gather needed tools before proceeding with the installation. Read and follow the instructions provided with any tools listed here.

Tools Needed

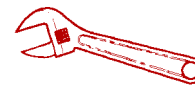

Adjustable Wrench



Phillips Screwdriver

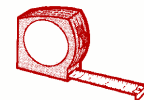

Tape Measure



Drill & Drill bits, if required

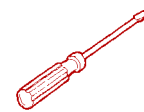

Flathead Screwdriver



Large Adjustable Jaw Pliers or Pipe Wrench



Figure 1

Questions? Call The Kenmore Water Line 1-800-426-9345 or visit KenmoreWater.com

Plan Your Installation

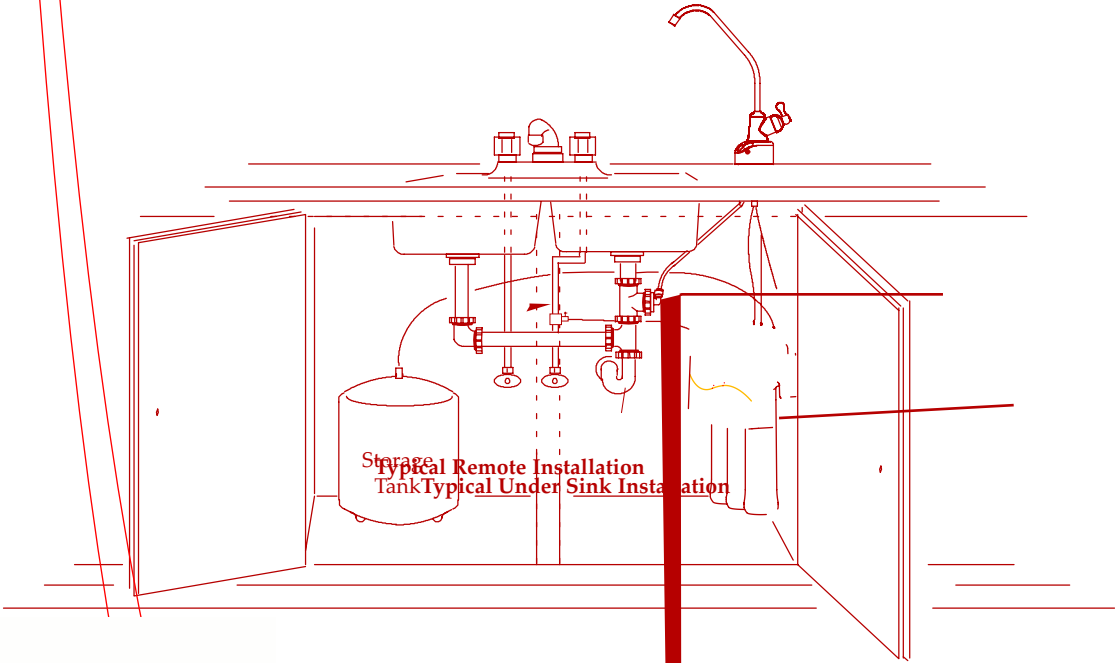

Questions? Call The Kenmore Water Line 1-800-426-9345 or visit KenmoreWater.com

Overview and Site Preparation

OVERVIEW

There are seven easy steps to installing your Drinking Water system. They are as follows:

- STEP 1** - Install Cold Water Supply fitting
- STEP 2** - Install Drain Adapter
- STEP 3** - Install Reverse Osmosis Assembly
- STEP 4** - Install Storage Tank
- STEP 5** - Install Reverse Osmosis Faucet
- STEP 6** - Connect Tubing
- STEP 7** - Sanitize, Pressure Test, Purge System

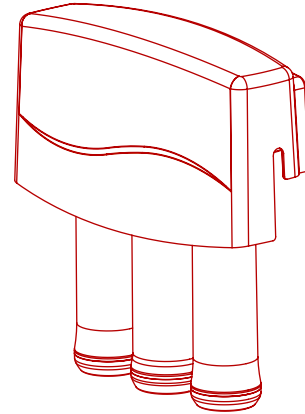

Figure 4

These steps are explained in detail over the next few pages.

It is recommended to read through the entire manual before beginning your installation. Follow all steps exactly. Reading this manual will also help you receive and use all the benefits your Reverse Osmosis System can give you.

PREPARE SITE FOR INSTALLATION

1. Before starting, close the hot and cold water shutoff valves (See Figure 5).
2. Temporarily place tank and filter assembly into cabinet. Double check position of items and space required for proper installation.
3. Remove tank and filter from cabinet and set aside.

NOTE: You must check and comply with all local plumbing codes.

Step 1 - Install Supply Water Fitting

CHOOSE TYPE OF WATER FITTING TO INSTALL

Locate the cold water line in the sink cabinet. It is recommended, but not required, that the cold water line be soft water. You can use the saddle valve provided with your unit to tap into the cold water line. See Fig. 5. Or you can purchase standard pipe fittings locally such as a compression fitting. The fitting must provide a leak-tight connection to the Reverse Osmosis 1/4" tube.

NOTE: Local code may dictate which type of water fitting is used. Consult a plumber if you are not familiar with local codes or plumbing procedures.

NOTE: Codes in the state of Massachusetts require installation by a licensed plumber and do not permit the use of saddle valves.

If you live in the state of Massachusetts, review plumbing code 248-CMR of the Commonwealth of Massachusetts before proceeding with the installation.

INSTALL SADDLE VALVE

(Included with your package)

This fitting will be installed on the cold water pipe. The fitting must provide a leak-tight connection to the Reverse Osmosis 1/4" tubing.

Complete the following steps to install the saddle valve assembly.

1. Review Fig. 5 and familiarize yourself with all parts of the saddle valve. This valve will self-tap a hole in copper tubing or plastic pipe.

IMPORTANT: Before starting, close the hot and cold water shutoff valves (See Figure 5).

2. If installing on iron pipe, drill a 1/8" hole for the piercing pin.

IMPORTANT: If a battery-powered hand drill is not available and an electric drill is used, ensure that the drill is properly grounded.

3. Place the seal on the inside of Clamp X. See Fig. 5.

Turn the valve handle all the way out. (counter-clockwise) Be sure the piercing pin does not stick out beyond the seal.

4. Place Clamp X and Z around the pipe. Secure in place with two screws. Tighten both screws evenly. Do not over tighten screws. See Fig. 5.

5. Turn the valve handle all the way in. (clockwise) This will pierce the wall of the pipe. See Fig. 5.

6. **Do not** connect the tubing to the fitting at this time. This will occur later in the installation.

NOTE: Once the saddle valve is installed, the nut near the handle may need to be tightened to prevent possible leaks.

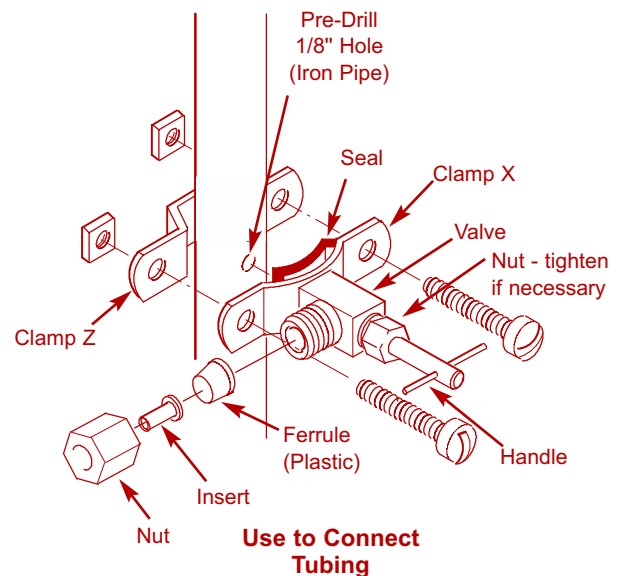
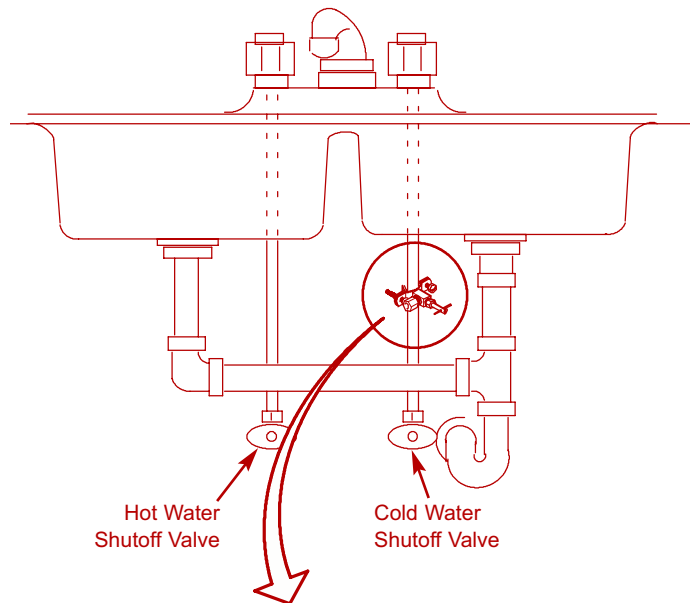

**Saddle Valve Connection
(Included in package)**

Figure 5

Step 2 - Install RO Drain Under Sink

INTRODUCTION

A suitable drain point is needed for the reject water from the Reverse Osmosis Filter. You have two options to choose from:

- **Install the Drain Adapter included with your unit**
See Figures 6, 7 & 8. This is used in under the sink installations. The drain adapter kit is installed onto your sink drain pipe above the P-trap. See Figure 6.
- **Use another existing drain in your home**
This is usually used in remote location type installations. The drain tube from the Reverse Osmosis Filter runs directly to an open drain. See Figures 9 & 10.

NOTE: Local code may dictate which type of drain installation is used. Other than local code, either drain installation types may be used. Consult a plumber if you are not familiar with plumbing procedures.

INSTALL DRAIN ADAPTER KIT (Under sink Installation)

In an under the sink installation, you normally use the P-trap drain adapter. A drain adapter kit is included in your package. Review the drain adapter kit parts in Figure 8. The drain adapter is always installed in the sink drain pipe, above or ahead of the P-trap. See Figures 6 & 8. Be sure to comply with your local plumbing codes. The drain adapter fits 1-1/2" sink drain pipes. Other drain pipe fittings, purchased locally, may be needed in addition to the adapter.

1. Slowly disassemble the sink drain pipe between the sink P-trap and the sink tailpiece. See Figures 6 & 8.
2. Clean the sink tailpiece to assure a leak-tight fit.
3. Install drain adapter directly onto the sink tailpiece using the ferrule and nut. Snug the nut, but do not tighten. See Figure 7.
4. Assemble the drain tubing connector to the drain adapter using the ferrule and nut. Snug the nut, but do not tighten. See Figure 7.

NOTE: Locate so drain tubing from the Reverse Osmosis faucet will make a straight run to the adapter, without dips, loops, low spots or kinks. See Figure 8.

5. Turn the connector to about 45° (10:00 or 2:00 position). See Figure 7. Tighten the nut securely.
6. Assemble the P-trap to the drain adapter, and other drain pipe fittings as required to complete the drain run. See Figure 6.

NOTE: If needed, you can cut the unthreaded end of the adapter to make it fit. Do not cut too short or the adapter will not make a leak-tight seal with the connecting fitting.

7. Tighten all connections, but do not over tighten plastic connections.

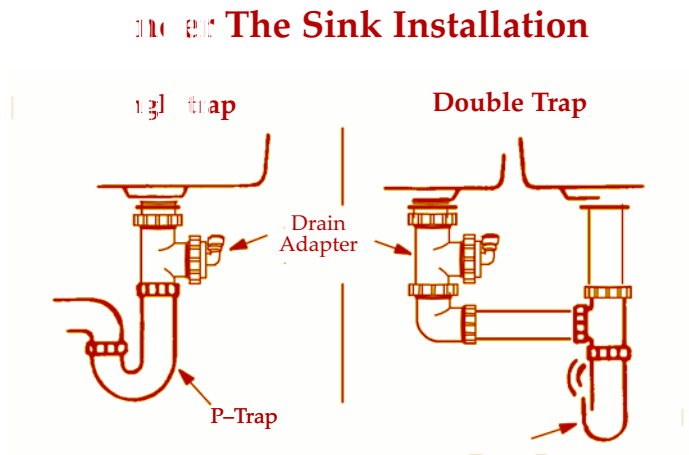

Figure 6

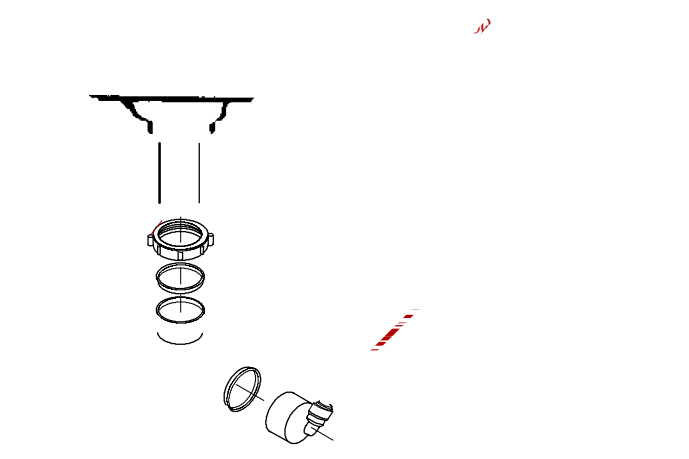

Figure 7



Figure 8

Step 2 - Install RO Drain In Remote Location



Questions? Call The Kenmore Water Line 1-800-426-9345 or visit KenmoreWater.com

Step 3 - Install RO Filter Assembly

INSTALL REVERSE OSMOSIS FILTER ASSEMBLY

The Reverse Osmosis Filter Assembly is mounted on hanger washers. The hanger washers allow you to lift the filter assembly from the washers without any hardware removal. When planning your installation, you need to leave room for changing filters. See Figure 11.

Complete the following steps to install your Reverse Osmosis Filter Assembly:

1. Remove the cover.
2. Locate mounting slots on back of the assembly. See Figure 11.
3. Hold the assembly up to the wall surface and mark locations for the hanger washers. This allows room to change filters.
4. Fasten the hanger washers to the wall using the wood screws provided.
5. Hang assembly on washers.
6. Replace cover.

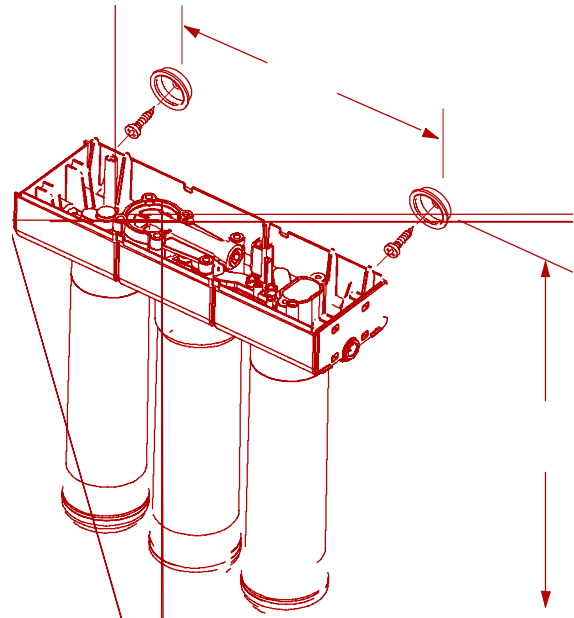

Figure 11

Step 4 - Install Storage Tank

INSTALL STORAGE TANK

1. Apply thread sealing tape to the threads on the nipple at the top of the tank (max. 2 wraps). See Figure 12.
2. Locate the tubing connector. Tighten the tubing connector with a wrench onto the tank nipple 7-8 turns, being careful not to cross thread or overtighten. See Figure 12
3. Do not connect the tube at this time. This will occur later in the assembly.
4. Place the storage tank next to the Reverse Osmosis Assembly. The tank can be placed upright or on its side.

Figure 12

Step 5 - Install RO Faucet

SELECT LOCATION OF REVERSE OSMOSIS FAUCET MOUNTING HOLE

You will need to select the location of the Reverse Osmosis Faucet. You have three options to choose from:

- Use the existing sink top hole for the spray hose or soap dispenser (Must be 1-1/4" in diameter)
- Drill a new hole in the sink
- Drill a new hole in the countertop next to the sink

1. Determine where you are going to install your Reverse Osmosis Faucet.
2. Check to ensure the Reverse Osmosis faucet will mount flat against the mounting surface.
3. Visually review the routing of the tubes from the Reverse Osmosis filter assembly to the faucet. Check to ensure there is adequate tube routing space between the faucet and filter assembly.
4. If drilling is needed, drill a 1-1/4" diameter hole in the mounting surface.

IMPORTANT: Drilling holes into countertops and sinks should only be performed by a qualified installer who is certified for drilling such materials. Drilling of surfaces made of stone or solid surface materials such as granite, marble, Corian™ or other plastic resin products or sinks made of porcelain and stainless steel may cause permanent, irreparable damage to the sink or countertop surface.

INSTALL REVERSE OSMOSIS FAUCET

1. Locate and organize your RO faucet install parts. Refer to Figure 14.
2. Mount faucet base to sink hole until the faucet base is square against the sink surface. The rubber gasket should be between the sink surface and the faucet base.
3. Tighten the toggle bolts until the base is firmly mounted to the sink surface. Do not overtighten.
4. Locate the faucet base. The black and blue tubes are already connected to the faucet. Insert these tubes into the sink hole until approximately one foot of tube length and the faucet base are left above the counter surface. Do not bend or kink the tubes in the process. See Figures 15 and 21.

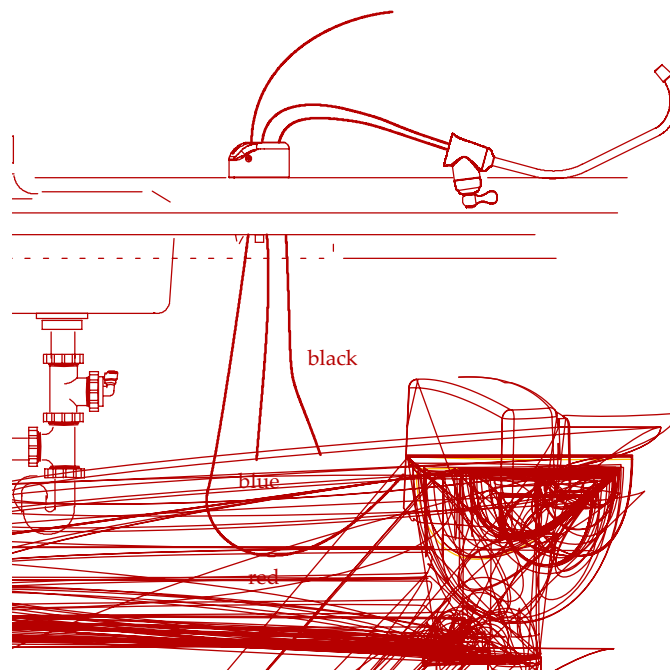

Figure 13

Step 5 - Install RO Faucet

5. Locate the 1/4" red tubing. One end is connected to the RO Filter assembly. See Figure 21. Locate the loose end.

- A. Route red tube through countertop to faucet.
- B. Cut the loose end of the red tube square and to length. See Figure 21.

NOTE: Tubing lengths should allow for the removal of the assembly from the hanger washers for servicing. If tubing lengths are shortened for neater appearance, it may be necessary to keep the assembly on the hanger washers for service.

C. Insert all the way onto the 1/4" faucet barb fitting on faucet. See Figure 15.

D. Pull on the tubing to be sure it is held firmly in the fitting.

NOTE: If you ran the red reverse osmosis drain tubing directly to a remote drain point, disregard step 3 and refer to instructions on page 10.

6. Mount the faucet body on to the faucet base, 1/4 turn.

FAUCET ELECTRONICS

Inside the faucet base is a battery operated 6 month timer. See Figure 14.

An amber LED indicator is also located in the front of the faucet base. This LED will flash continuously after 6 months has passed. This indicates that it is time to replace the battery, prefilter and postfilter.

INSTALL BATTERY

To install battery, complete the following steps.

1. Loosen the screw on the right side of the faucet base. See Figure 14.
2. Press the battery housing upwards from the front faucet base until it releases from the faucet base. See Figure 14.
3. Replace the battery (CR 2032 or equivalent). Place the positive (+) side down into the holder.
4. When the battery is first replaced it will flash six times and turn off. This indicates the battery is fully charged. After the six flashes the timer enters the 6 month time cycle. If it repeatedly flashes just two times, it is not a fully charged battery and will need to be replaced.
5. Re-install the timer housing and firmly tighten the mounting screw. See Figure 14.

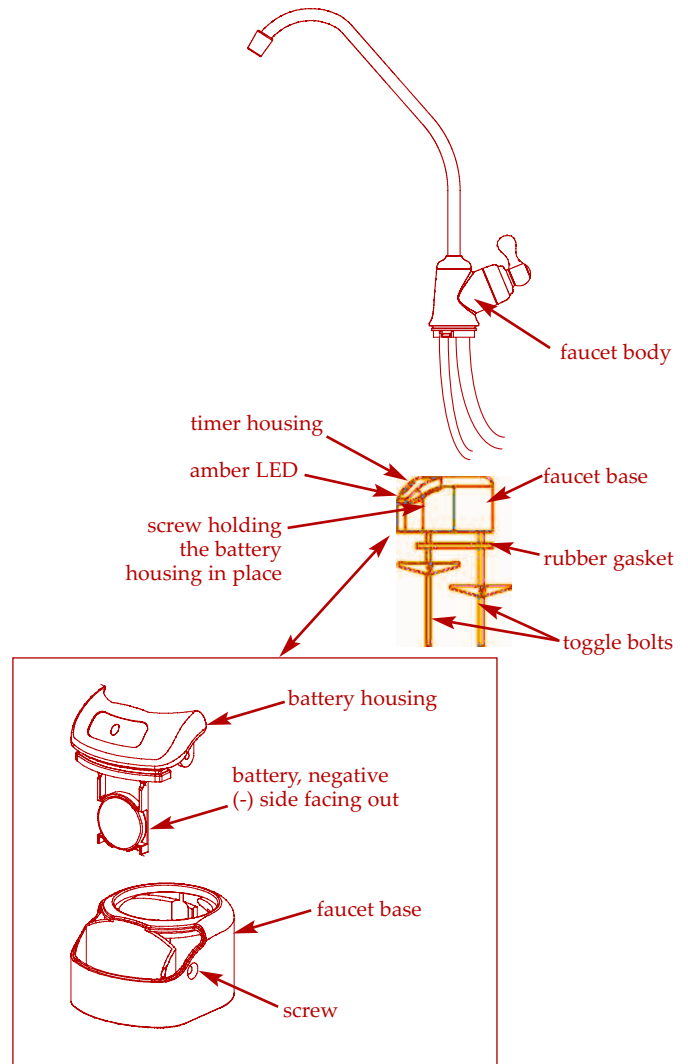

Figure 14

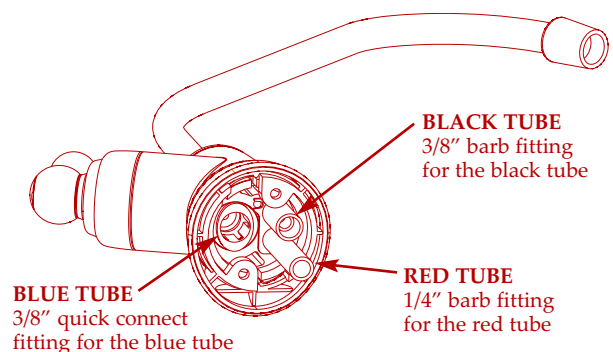

Figure 15

Step 6 - Connect Tubes

HOW TO CUT AND CONNECT THE TUBES

Your Reverse Osmosis Water System includes push-in fittings for quick tubing connection. Review the following instructions before connecting the tubes in the next step.

Cut tubes to length

1. Use a sharp cutter or knife to cut the end of tubing. Always cut the tubing square. See Figure 16.
2. Inspect the end (about 1") of the tubing to be sure there are no nicks, scratches or other rough spots. If needed, cut the tubing again. See Figure 16.

NOTE: Tubing lengths should allow for the removal of the assembly from the hanger washers for servicing. If tubing lengths are shortened for neater appearance, it may be necessary to keep the assembly on the hanger washers for service.

Connect tubes

1. Push tubing through collet, until it engages the o-ring. See Figure 17. Continue pushing until the tube bottoms out against the back of the fitting. See Figure 18. A common mistake is to stop pushing when the tube engages the o-ring. This will lead to future leaks. When a 1/4" tube is fully engaged, 11/16" of the tube has entered the fitting. When a 3/8" tube is fully engaged, 3/4" of the tube has entered the fitting. See Figures 17 & 18.
2. If using tubing other than tubing supplied with the system, be sure it is of high quality, exact size and roundness with a smooth surface.

Disconnect Tubes

1. Push the collet inward with a finger tip. See Figure 20.
2. Continue holding collet inward while pulling the tubing out. See Figure 20.

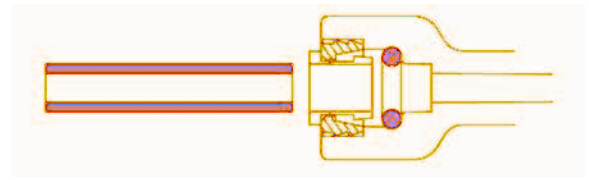

Figure 16

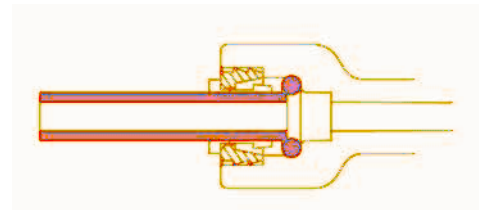

Figure 17

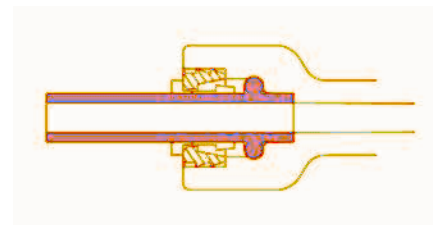

Figure 18



Figure 20

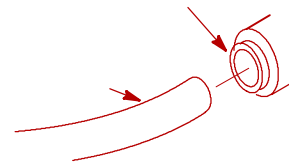

Figure 19

Step 6 - Connect Tubes

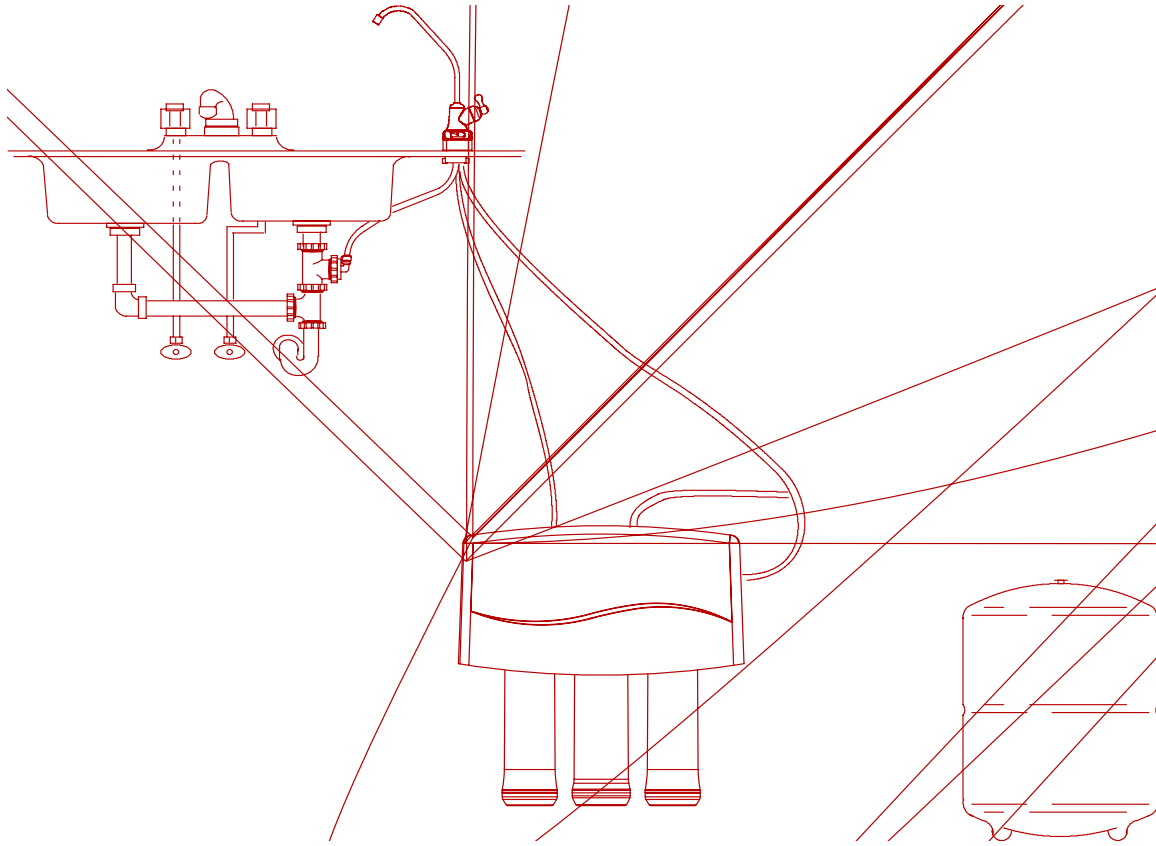

Figure 21

Step 7 - Sanitize, Test and Purge System

SANITIZE THE SYSTEM

Sanitizing is recommended immediately after installation of the Reverse Osmosis system. It's also recommended after servicing inner parts. It is important that the person installing or servicing the system have clean hands while handling inner parts of the system.

Complete the following steps to sanitize the system. See Figure 22.

1. Turn off the water supply to the Reverse Osmosis system.
2. Open the Reverse Osmosis faucet.
3. Locate the eyedropper that is included in package and common household bleach (5.25%).
4. Add 3 ml. of bleach into open end of yellow tank tubing. Handle bleach according to bleach manufacturer's recommendations. See Figure 22.
5. Connect yellow tank tubing to tank connector. See Figures 12 and 22.
6. Sanitizing the system will be completed during the pressure test and purging steps on the following page.
NOTE: The bleach must be removed from the system before drinking the water. See purging instructions on the next page.

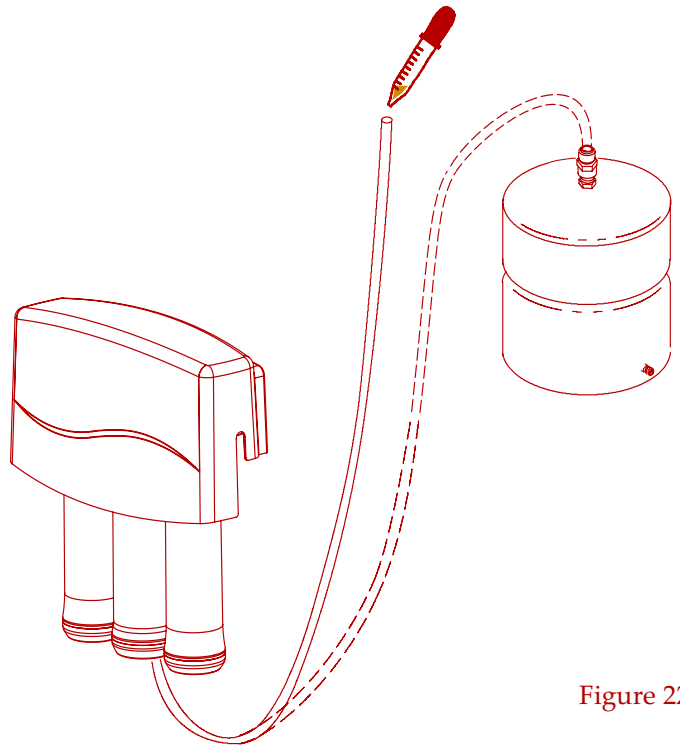

Figure 22

Step 7 - Sanitize, Test and Purge System

PRESSURE TEST THE SYSTEM

NOTE: Complete the sanitizing procedures on the preceding page before pressure testing.

To pressure test the system, complete the following steps.

1. Open the water supply valve to the Reverse Osmosis System. See Figure 23.
2. Open the main water supply valve and several house faucets. This will purge air from the house plumbing and system. Close faucets when water runs smooth. See Figure 23.
3. Pressure will start to build in the RO system in about 2 hours Carefully check all fittings and connections as the system builds pressure. Check for water leaks. Fix leaks if any are found. If problems exist, refer to the troubleshooting chart or call the toll free number.

NOTE: When the system is first pressurized, water may "spurt" from the faucet air gap hole until air is expelled from the RO system.

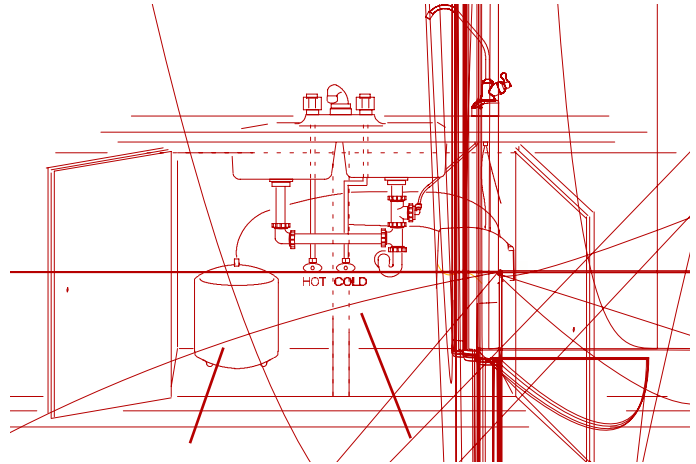

Figure 23

Please review the following operating features before using your Reverse Osmosis System:

You will *not* have filtered water immediately. It may take 1-3 hours to completely fill the storage tank and create maximum flow from the Reverse Osmosis faucet.

Water Pressure from the Reverse Osmosis faucet will be less than your standard faucet due to the high level of filtration performed by the system.

Water will run to the drain while the Reverse Osmosis system is producing purified water, even if you are not drawing water from the Reverse Osmosis faucet. You may hear a small quantity of water going to the drain for a couple of hours. Water going to the drain will automatically shut off when the storage tank is full.

PURGING THE SYSTEM

To purge the system, complete the following steps.

1. Open the Reverse Osmosis Faucet and let water through the system for a 24 hour period.
NOTE: Water flow will be a slow trickle at this time.
2. Close the Reverse Osmosis faucet after the 24 hour purging period is complete.
3. When the purging is finished, your Reverse Osmosis system is ready for use.

How Your RO Water System Works

HOW YOUR REVERSE OSMOSIS SYSTEM WORKS

Introduction: Your Reverse Osmosis (RO) Drinking Water System uses your household water pressure to force water through three filters. Minerals and impurities are filtered out. Delicious tasting drinking water goes to the storage tank-ready for your use. Minerals and impurities are sent down the drain. The following paragraphs will explain in detail how your Reverse Osmosis Drinking Water System works.

Prefilter: Water from the cold supply pipe enters the prefilter. See Figure 24. The prefilter has a replaceable sediment cartridge with activated carbon in its composition. The cartridge reduces taste, odor, sand, silt, dirt, other sediments, and up to the amount of chlorine shown in the specifications.

Reverse Osmosis Cartridge: Filtered, chlorine-free water flows from the prefilter, to the Reverse Osmosis membrane cartridge. See Figure 24. The Reverse Osmosis cartridge is a tightly wound special membrane. The membrane reduces the dissolved solids and organic matter. High quality product water (about one ounce per minute) exits the Reverse Osmosis cartridge. The product water flows to the storage tank, postfilter or Reverse Osmosis faucet. See Figure 24. Reject water, with the dissolved solids and organic matter, is routed to the drain. See Figure 24.

Storage Tank: The storage tank holds up to 2.4 gallons of product water. See Figure 24. A diaphragm inside the tank holds water pressurized to about 30 psi when the tank is full. This provides fast flow to the Reverse Osmosis faucet. When the tank is empty of water, it is pressurized to 5 - 7 psi.

Postfilter: Before going to the Reverse Osmosis faucet, product water goes through the postfilter. See Figure 24. The postfilter is an activated carbon type filter. Any remaining tastes and odors are reduced from the product water. Taste-free, odor-free, clean, high quality drinking water is available at the faucet.

Reverse Osmosis Faucet: The sink or countertop faucet has a hand operated knob to access drinking water. See Figure 24. An air-gap is built into the faucet drain water connection to comply with plumbing codes. See Figure 24.

Faucet Electronics: Inside the faucet base is a battery operated 6 month timer. See Figure 14. An amber LED indicator is also located in the front of the faucet base. This LED will flash continuously after 6 months have passed. This indicates that it is time to replace the battery, prefilter and postfilter.

Shutoff Assembly: The unit has an automatic shutoff system to conserve water. When the storage tank has filled to capacity, and the drinking water faucet is closed, pressure closes the shutoff to stop flow to the drain. After enough drinking water is used, pressure in the system drops, and the shutoff opens to allow the tank to be refilled. See Figure 24.

Check Valve: A check valve is located in the Reverse Osmosis manifold, above the center sump. The check valve prevents a backward flow of product water from the storage tank to drain. A backward flow could damage the Reverse Osmosis Membrane. See Figure 24.

Flow Control: Water flow to the drain is restricted by the flow control. It maintains the desired flow rate to obtain the highest quality drinking water. The flow control is located in the end of the 1/4" red drain tubing, at the Reverse Osmosis manifold drain port. See Figure 24.

How Your RO Water System Works

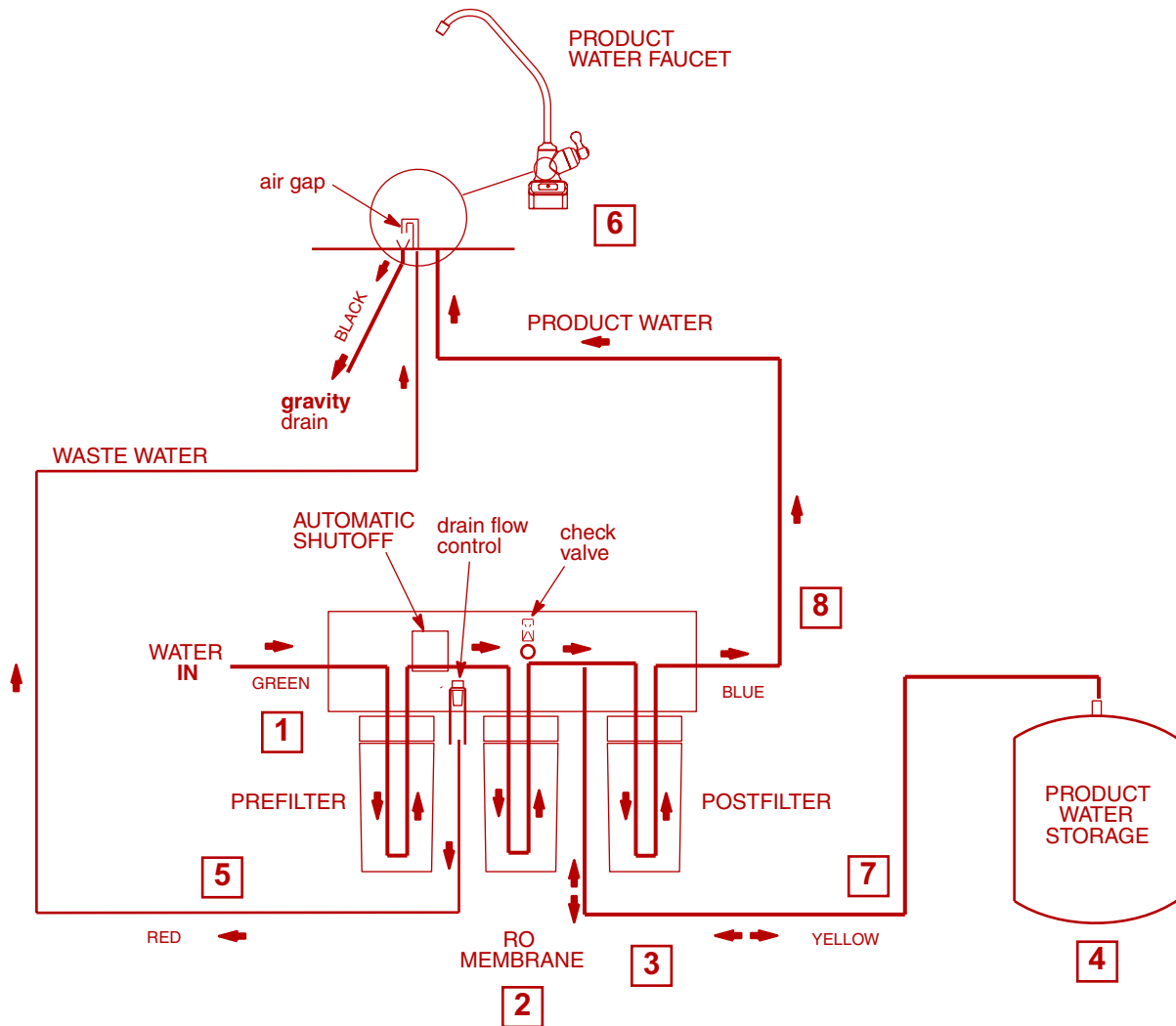

Reverse Osmosis Water Flow Schematic

Figure 24

Water Flow Description

1. Water enters prefilter. Sand, silt and other sediments are reduced. Chlorine is also reduced.
2. Water leaves prefilter and proceeds to the Reverse Osmosis Cartridge.
3. Water enters the Reverse Osmosis membrane. Dissolved solids are reduced.
4. Processed water leaves the Reverse Osmosis Membrane and flows to the storage tank.
5. Waste water with dissolved solids leave the Reverse Osmosis membrane and flows to the drain.
6. Faucet is activated.
7. Processed water leaves the storage tank and flows to the post filter filtered to ensure fresh taste.
8. Water flows to the Reverse Osmosis faucet.

Questions? Call The Kenmore Water Line 1-800-426-9345 or visit KenmoreWater.com

Maintenance

PREFILTER/POSTFILTER MAINTENANCE

NOTE: It is recommended to replace the battery, prefilter and postfilter cartridges at least every 6 months of product water use. Replace more often if they begin to plug with sediments.

The prefilter and postfilter are replaceable sediment cartridges with activated carbon in its composition. See Figure 25. You must periodically replace the prefilter and postfilter cartridge. This will protect the RO membrane from being destroyed by chlorine. It will also prevent the filters from plugging with sediments.

You may notice a slower output of product water as the prefilter and postfilter build up with sediments. Replace the prefilter and postfilter cartridges when this occurs. You should replace the battery whenever you replace the cartridges.

RO MEMBRANE CARTRIDGE MAINTENANCE

The Reverse Osmosis cartridge is a tightly wound special membrane. See Figure 25. The membrane reduces the *dissolved* solids and organic matter. The life of the Reverse Osmosis membrane cartridge depends mostly on the pH of the supply water. (see specifications).

Cartridge life is shorter with higher pH. For example, if supply water pH is from 6.8 to 7.7, the cartridge may last for well over one year. However, cartridge life may be as short as 6 months if the pH is as high as 8.5 to 10. Higher pH weakens the cartridge membrane and causes pin-hole leaks. It's time to replace the Reverse Osmosis cartridge when the production rate and/or quality of product water drops. Product water may begin to taste different or bad, indicating solids and organics are passing through the Reverse Osmosis membrane. See Reverse Osmosis cartridge replacement.

REVERSE OSMOSIS CARTRIDGE REPLACEMENT

Complete the following steps to replace the cartridges.

1. If possible, turn off the water supply to the RO system.
2. Remove (turn to the left) the pre filter cartridge from the filter head to relieve pressure on the Reverse Osmosis cartridge.
3. Remove the Reverse Osmosis cartridge.
4. Remove the postfilter cartridge.
5. Discard the cartridges in a proper manner.
6. Install new cartridges in reverse order (postfilter, Reverse Osmosis and then prefilter). Turn cartridges to the right to re-attach to the filter heads.
7. Remove and replace the timer battery. See Figure 14.
8. Turn on the water supply to the RO system.
9. Purge the Reverse Osmosis membrane cartridge. See page 17 for instructions.

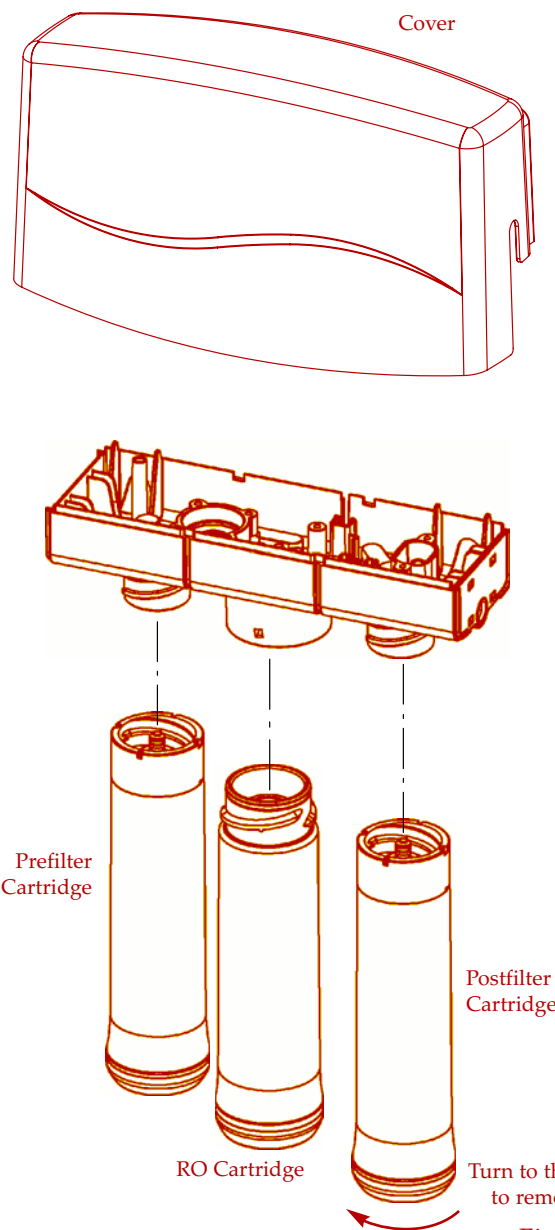

Figure 25

PREFILTER/POSTFILTER CARTRIDGE REPLACEMENT

Complete the following steps to replace the cartridges.

1. If possible, turn off the water supply to the RO system.
2. Remove the pre filter cartridge (turn to the left) from the filter head. Then remove the post filter cartridge.
3. Discard the cartridges in a proper manner.
4. Install new cartridges in reverse order (postfilter first, then pre filter). Turn cartridges to the right to re-attach to the filter heads.
5. Remove and replace the timer battery. See Figure 14.
6. Turn on the water supply to the RO system.
7. Purge the Reverse Osmosis membrane cartridge. See page 17 for instructions.

Maintenance

FLOW CONTROL

The flow control is vital for proper operation of the Reverse Osmosis membrane cartridge. See Figure 26. The control keeps water flowing through the membrane at the required rate. This is to ensure the system produces the best quality product water.

Periodically check the flow control assembly to be sure the small hole through it is clean and unrestricted.

If the flow control assembly requires service, review the exploded view in Figure 26. Assemble and disassemble as shown.

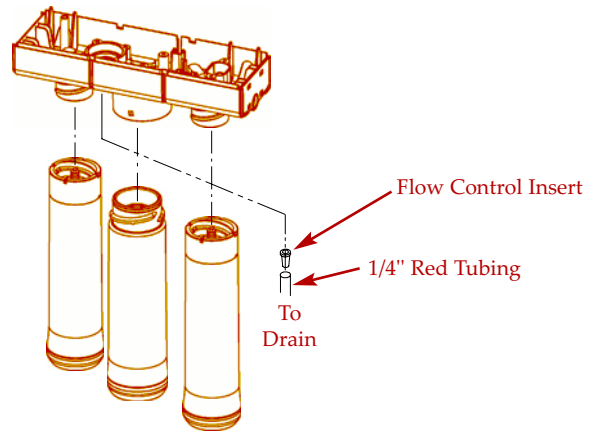
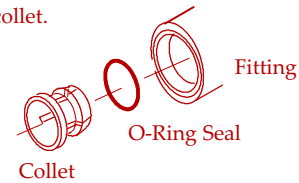

Figure 26

CHANGE COLLET AND O-RING

1. Remove the collet and o-ring from the fitting with a small screwdriver. Be careful not to scratch the internal walls of the collet port. See Figures 27 & 28.
2. Clean collet port, lubricate and insert the o-ring seal into the bottom of the port. See Figures 27 & 28.
3. Push the collet inward until it locks in place. See Figures 27 & 28.

Push o-ring seal into bottom of port then follow with collet.



Change collet and o-ring

Figure 27

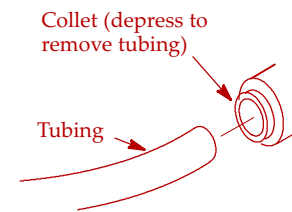

Disconnect Tubing

Figure 28

CHANGE BATTERY

To change battery, complete the following steps.

1. Loosen the screw on the right side of the faucet base. See Figure 29.
2. Press the battery housing upwards from the front faucet base until it releases from the faucet base. See Figure 29.
3. Replace the battery. (Maxell-CR 2032 or equivalent)
4. When the battery is first replaced it will flash six times and turn off. This indicates the battery is fully charged. After the six flashes the timer enters the 6 month time cycle. If it repeatedly flashes just two times, it is not a fully charged battery.
5. Re-install the battery housing and firmly tighten the mounting screw. See Figure 29.

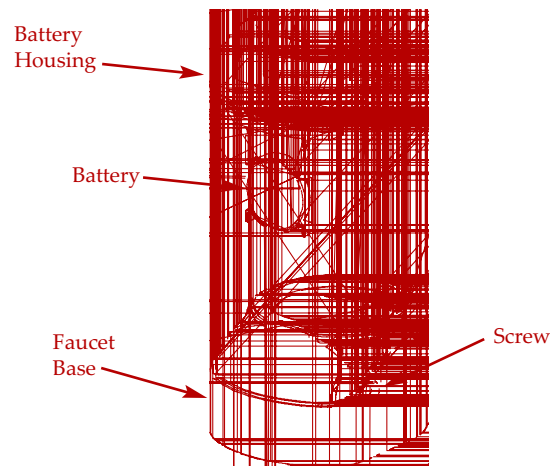

Figure 29

Specifications

Supply water pressure limits	.40-100 psi (280-689 kPa)
Supply water temperature limits	.40-100 °F (5-40°C)
Maximum total dissolved solids (TDS)	.2000 ppm
Maximum water hardness @ 6.9 pH	10 gpg
Maximum iron, manganese, hydrogen sulfide	.0
Chlorine in water supply (max. ppm)	.2.0
Supply water pH limits (pH)	4-10
Product (quality) water, 24 hours ¹	14.53 gal. (55 liters)
Waste water per gallon of product water ¹	5 gal. (18.9 liters)
Percent rejection of TDS, minimum (new membrane) ¹	.90-95
Storage tank capacity (max.)	.2.4 gal. (9.1 liters)
Automatic shutoff control	.yes
Efficiency ²	.9.7 %
Recovery ³	.19.7 %

This system conforms to NSF/ANSI 58 for the specific performance claims as verified and substantiated by test data.

¹@ Feed water supply at 50 psi, 77°F, and 750 TDS. Quality water production, amount of waste water and percent rejection all vary with changes in pressure, temperature and total dissolved solids.

²Efficiency rating means the percentage of the influent water to the system that is available to the user as reverse osmosis treated water under operating conditions that approximate typical daily usage.

³Recovery rating means the percentage of the influent water to the membrane portion of the system that is available to the user as reverse osmosis treated water when the system is operated without a storage tank or when the storage tank is bypassed.

Non-potable Water Sources: Do not attempt to use this product to make safe drinking water from non-potable water sources. Do not use the system on microbiologically unsafe water, or water of unknown quality without an adequate disinfection before or after the system. This system is certified for cyst reduction and may be used on disinfected water that may contain filterable cysts.

Arsenic Reduction: This system shall only be used for arsenic reduction on chlorinated water supplies containing detectable residual free chlorine at the system inlet. Water systems using an inline chlorinator should provide a one minute chlorine contact time before the reverse osmosis system.

Nitrate/Nitrite Test Kit: This system is acceptable for treatment of influent concentrations of no more than 27mg/L nitrate and 3mg/L nitrite in combination measured as N. It is certified for nitrate/nitrite reduction only for water supplies with a pressure of 280 kPa (40 psig) or greater. This system is supplied with a nitrate/nitrite test kit. Product water should be monitored periodically according to the instructions provided with the test kit.

TDS Test Kits: TDS test kits are available by calling 1--800--949--8220, or check the water testing section of your local phone directory.

Installations In The Commonwealth Of Massachusetts: The Commonwealth of Massachusetts requires installation be performed by a licensed plumber. Plumbing code 248--CMR of the Commonwealth of Massachusetts must be followed in these cases.

Product Water Testing: The Reverse Osmosis System contains a replaceable treatment component critical for the effective reduction of total dissolved solids. Product water should be tested periodically to verify that the system is performing properly.

Replacement of the reverse osmosis component: This reverse osmosis system contains a replaceable component critical to the efficiency of the system. Replacement of the reverse osmosis component should be with one of identical specifications, as defined by the manufacturer, to assure the same efficiency and contaminant performance.

Questions? Call The Kenmore Water Line 1-800-426-9345 or visit KenmoreWater.com

Notes

Troubleshooting

Problem: Chlorine taste and/or odor in the RO product water.

Cause: The level of chlorine in your water supply exceeds maximum limits, and has destroyed the Reverse Osmosis membrane.	Correction: If the water supply contains more than 2.0 ppm of chlorine, additional filtering of the water supply to the Reverse Osmosis is needed. Correct this condition before doing maintenance on the Reverse Osmosis system.
Cause: The prefilter is no longer reducing chlorine from the water supply.	Correction: Replace the prefilter, postfilter and Reverse Osmosis membrane cartridges. See page 20.

Problem: Other taste and/or odor.

Cause: Postfilter expended.	Correction: Replace the post filter cartridge. If taste and odor persists, replace the prefilter cartridge and Reverse Osmosis membrane cartridge. See page 20.
Cause: Reverse Osmosis membrane cartridge expended.	
Cause: Contamination in product water storage tank.	Correction: Use sanitizing procedures. Replace pre and post filter cartridge. See pages 16 & 20.
Cause: System contamination.	Correction: Sanitize entire system. Call 1-800-426-9345 for instructions.

Problem: System makes product water too slowly.

Cause: Water supply to the Reverse Osmosis system not within specifications.	Correction: Increase water pressure, precondition the water, etc., as needed to conform before doing maintenance on the Reverse Osmosis system.
Cause: Prefilter or Reverse Osmosis membrane cartridges plugged with sediments.	Correction: Replace the prefilter cartridge. If rate does not increase, replace the postfilter cartridge and Reverse Osmosis membrane cartridge. See page 20.

Problem: System makes lower amount of product water than usual.

Cause: Storage tank air-charge less than 5-7 psi.	Correction: Open Reverse Osmosis faucet and drain tank until flow slows to a drip. Keep faucet open and check tank pressure. If low, pressurize to 6 psi. Close faucet to refill the tank.
--	---

Problem: High total dissolved solids (TDS) in product water

Cause: Water supply to the Reverse Osmosis system not within specifications.	Correction: Increase water pressure, precondition the water, etc., as needed to conform before doing maintenance on the Reverse Osmosis system.
	Correction: Send treated and untreated water samples to a water analysis lab for testing. It is important to test both the treated and untreated water to determine system performance. If the TDS is not within the system's performance guidelines, replace the prefilter, post filter and RO membrane cartridges.

Problem: Continual water flow to drain and no product water.

Cause: Missing flow control insert in red drain tube or its corresponding port.	Correction: Replace flow control insert. See page 21.
--	---

Troubleshooting

Problem: Water leaking from faucet airgap hole.

Cause: Drain side of faucet airgap (3/8" black tubing) plugged, restricted or incorrectly connected to drain point.

Correction: Inspect and eliminate restriction or plug. Refer to installation instructions for proper drain connection. **See page 9.**

Problem: Faucet LED indicator light does not function after battery change.

Cause: Battery dead.

Correction: Replace with new battery. **See page 21.**

Cause: Battery installed incorrectly.

Correction: Install battery correctly. **See pages 13 or 21.**

Problem: Water leaks at push connect fittings

Cause: Tubing not cut square.

Correction: Cut tubing square. **See page 14.**

Cause: Tubing not pushed in all the way.

Correction: Push tubing in all the way. **See page 14.**

Cause: Tubing nicked.

Correction: Remove tube from connection. Remove nicked portion by cutting tube to shorter length. Re-insert in connection. **See page 14.**

Cause: Outer tubing surface finish not smooth.

Correction: Remove tube from connection. Remove problem area by cutting tube to shorter length. Re-insert in connection. **See page 14.**

Exploded View

Questions? Call The Kenmore Water Line 1-800-426-9345 or visit KenmoreWater.com

Parts List

Key No.	Part No.	Description
1	9006062	Screw (2 req'd)
2	9041700	Hanger Washer (2 req'd)
3	7115432	O-ring (2 req'd)
4	7272658	Check Valve
5	7273337	Screw (6 req'd)
6	7281330	Washer (4 req'd)
7	7273345	Automatic Shut-off Cover
8	7250876	Diaphragm Kit
9	7234325	Plunger & Spacer Ring Kit
10	7275185	Flow (Control) Insert
11	3805605	Pre & Post Filter Cartridge *
12	3857705	RO Membrane Cartridge †
13	7256018	Storage Tank
14	7207938	Connector, Tank 1/4 NPT x 3/8 Quick Connect
15	7208489	Drain Adapter
16	7011272	Saddle Valve
17	7271872	Faucet, with Timer Base
18	7284508	Cover
19	7281005	Push-in Fitting Kit, 1/4" ◆ ●
20	7281013	Push-in Fitting Kit, 3/8" ◆ ●
■	7161823	Tubing, 1/4" x 20' - white ▲ ●
■	7161784	Tubing, 1/4" x 100' - white ▲ ●
■	7157280	Tubing, 3/8" x 20' - white ▲ ●
■	7161750	Tubing, 3/8" x 100' - white ▲ ●
■	7154818	Coin Battery
■	7279749	Dropper

* Please purchase replacement pre & post filter cartridges from the retail store where you bought your reverse osmosis system.

† Please call 1-800-4-MY-HOME (1-800-469-4663) to purchase replacement RO membrane cartridges.

◆ These o-rings and collets are for replacement in the manifold housing only. They do not fit the other push-in fitting on Key No. 16.

● Not included.

▲ Tubing lengths for remote installations, direct replacement for colored lengths of tubing.

■ Not illustrated.

Questions? Call The Kenmore Water Line 1-800-426-9345 or visit KenmoreWater.com

Get it fixed, at your home or ours!

Your Home

For repair – **in your home** – of **all** major brand appliances, lawn and garden equipment, or heating and cooling systems, **no matter who made it, no matter who sold it!**

For the replacement parts, accessories and owner's manuals that you need to do-it-yourself.

For Sears professional installation of home appliances and items like garage door openers and water heaters.

1-800-4-MY-HOME® (1-800-469-4663)

Call anytime, day or night (U.S.A. and Canada)

www.sears.com www.sears.ca

Our Home

For repair of carry-in items like vacuums, lawn equipment, and electronics, call or go on-line for the location of your nearest

Sears Parts & Repair Service Center

1-800-488-1222

Call anytime, day or night (U.S.A. only)

www.sears.com

To purchase a protection agreement (U.S.A.) or maintenance agreement (Canada) on a product serviced by Sears:

1-800-827-6655 (U.S.A.)

1-800-361-6665 (Canada)

Para pedir servicio de reparación a domicilio, y para ordenar piezas:

1-888-SU-HOGAR®

(1-888-784-6427)

Au Canada pour service en français:

1-800-LE-FOYER^{MC}

(1-800-533-6937)

www.sears.ca

