

Compact Disc Compact Player

Operating Instructions

About area code

The area code of the player you purchased is shown on upper left of the bar code label on the package. For accessories supplied with your player, check the area code of your model and refer to "Supplied accessories" toward the end of this manual.



D-191
D-192CK

Sony Corporation ©1999 Printed in China

Playing a CD right away!

If you want to play a CD right now, choose to use your player on house current. Other choices are the following two: dry batteries (see "Power Sources" on the reverse side) and car battery.

1 Connect

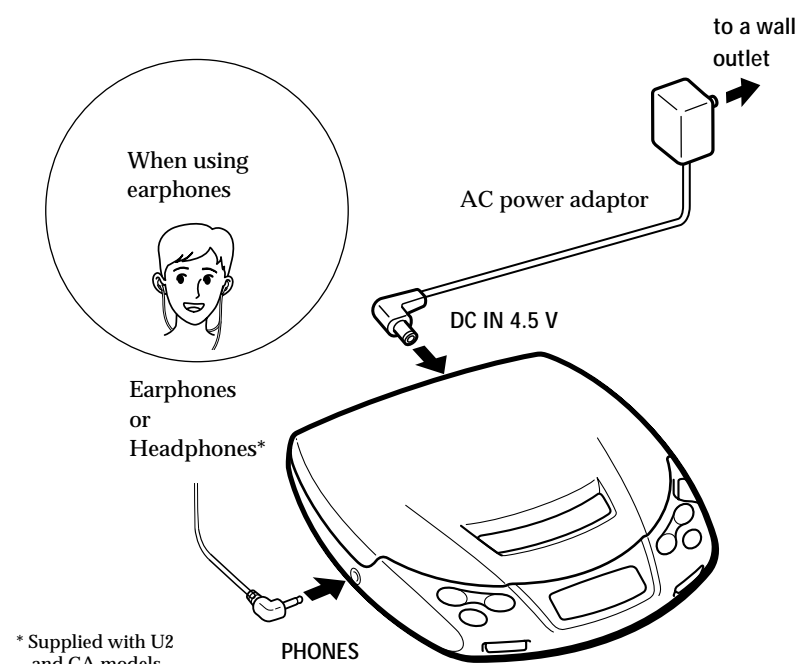

* Supplied with U2 and CA models

For models supplied with the AC plug adaptor
If the AC power adaptor does not fit the wall outlet, use the AC plug adaptor.

To	Press
Find the beginning of the current track (AMS*)	◀◀ once
Find the beginning of previous tracks (AMS)	◀◀ repeatedly**
Find the beginning of the next track (AMS)	▶▶ once
Find the beginning of succeeding tracks (AMS)	▶▶ repeatedly***
Go forward quickly	Hold down ▶▶
Go backwards quickly	Hold down ◀◀

* AMS = Automatic Music Sensor
** When using ◀◀: previous track → previous track first track → last track
***When using ▶▶: next track → next track last track → first track → second track

To remove the CD
Remove the CD while pressing the pivot.

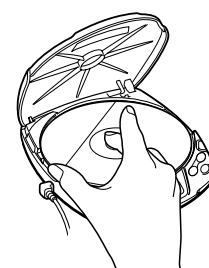

Notes on display

- When you press ▶, the total number of tracks in the CD and the total playing time appear.
- During play, the track number and the elapsed playing time of the current track appear.
- Between tracks, the time to the beginning of the next track will appear with the "--" indication.

Notes on handling CDs

- To keep the CD clean, handle it by its edge. Do not touch the surface.
- Do not stick paper or tape onto the CD.
- Do not expose the CD to direct sunlight or heat sources such as hot air ducts. Do not leave the CD in a car parked under direct sunlight.

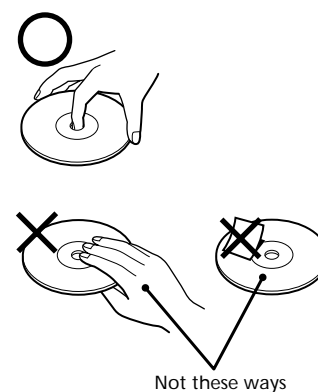

2 Place a CD

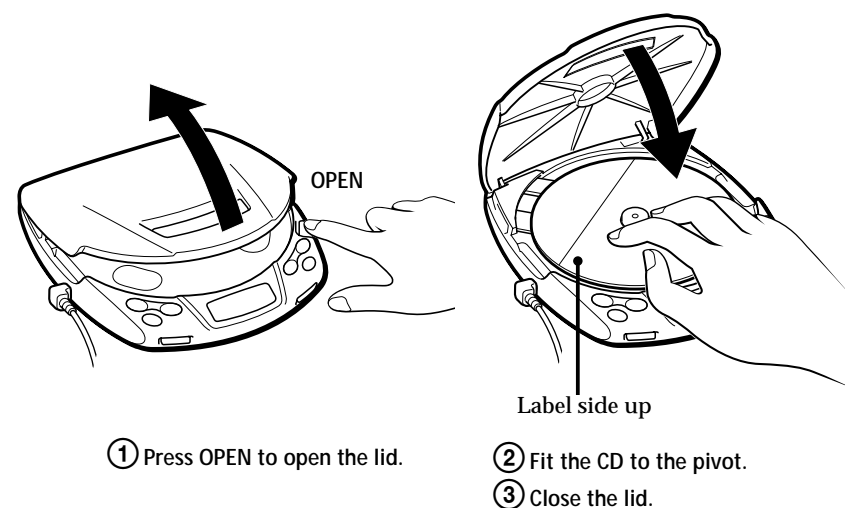

3 Play

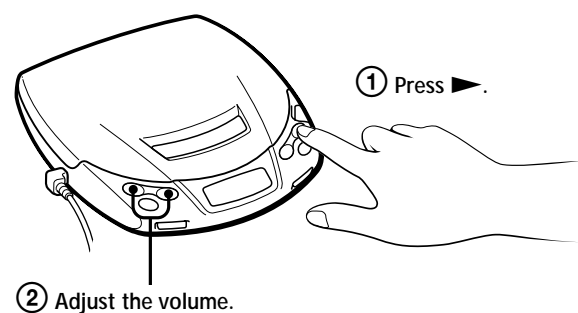

To stop play, press ■.

Note
If you press ■, the setting of the volume will be canceled. Whenever you play a CD, set it again by pressing VOL + or -.

Other Operations

Selecting play mode

You can enjoy the following five play modes: "Normal play", "Repeat play — all the tracks", "Single track play", "Repeat play — a single track" and "Repeat shuffle play".

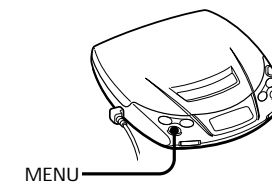

Press MENU during play. Each time you press the button, the play mode indication in the display changes as follows:

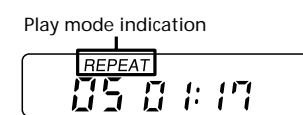

No indication (Normal play)
The player plays all the tracks on the CD once.

"REPEAT" (Repeat play — all the tracks)
The player plays all the tracks on the CD repeatedly.

"1" (Single track play)
The player plays a single track you've selected once.

"REPEAT 1" (Repeat play — a single track)
The player plays a single track you've selected repeatedly.

"REPEAT SHUFFLE" (Repeat shuffle play)
The player plays all the track on the CD in random order repeatedly.

Using other functions

To enjoy more powerful bass sound (Sound function)

You can enjoy a powerful bass-boosted sound.

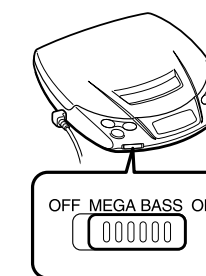

Set MEGA BASS to ON. "BASS" appears in the display.



Note
• If the sound is distorted when emphasizing bass, turn down the volume.

To lock the buttons
You can lock your player against any accidental operations.

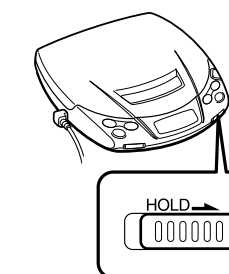

Slide HOLD in the direction of the arrow. When you press any button, "Hold" appears in the display and you cannot operate the player.

To unlock, slide HOLD back.

To protect your hearing (AVLS)
The AVLS (Automatic Volume Limiter System) function keeps down the maximum volume to protect your ears.

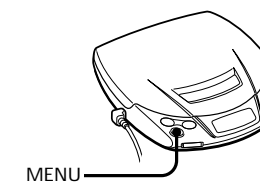

Hold down MENU until "AVLS" appears in the display.

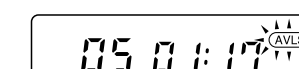

If you turn up the volume to "3.", you cannot turn up the volume any more.

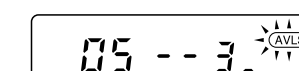

If you want to turn up the volume to more than "3.", hold down MENU until "AVLS" disappears from the display.

Note
• If you use the sound function and the AVLS function at the same time, sound may be distorted. If this happens, turn down the volume.

Connecting to other stereo equipment

You can listen to the CD through other stereo equipment or record a CD on a cassette tape. Refer to the instruction manual of the other equipment for details. Before making connections, turn off each piece of equipment.

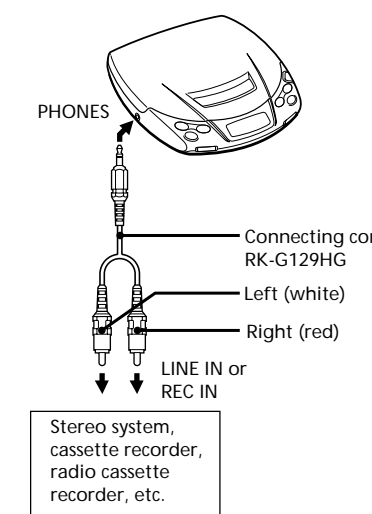

Note

- Before you play the CD, turn down the volume of the connected equipment so as not to damage the connected speakers.
- When you connect other equipment to the PHONES jack of this player, adjust the volume on the connected equipment.
- If you turn up the volume to more than "8.", the sound may be distorted.

Continue to the reverse side →

Welcome!

Thank you for purchasing the Sony Compact Disc Compact Player. Before operating your player, please read this manual and retain it for future reference.

About this manual

The instructions in this manual are for the D-191 and D-192CK. Before you start reading, check your model number. D-191 is the model used for illustration purposes.

Owner's Record

The model and the serial numbers are located at the bottom. Record these numbers in the spaces provided below. Refer to them whenever you call upon your Sony dealer regarding this product.

Model No. _____ Serial No. _____

WARNING

To prevent fire or shock hazard, do not expose the unit to rain or moisture.

To avoid electrical shock, do not open the cabinet. Refer servicing to qualified personnel only.

CAUTION
The use of optical instruments with this product will increase eye hazard.

For the customers in the USA

This equipment has been tested and found to comply with the limits for a Class B digital device, pursuant to Part 15 of the FCC Rules. These limits are designed to provide reasonable protection against harmful interference in a residential installation. This equipment generates, uses, and can radiate radio frequency energy and, if not installed and used in accordance with the instructions, may cause harmful interference to radio communications. However, there is no guarantee that interference will not occur in a particular installation. If this equipment does cause harmful interference to radio or television reception, which can be determined by turning the equipment off and on, the user is encouraged to try to correct the interference by one or more of the following measures:

- Reorient or relocate the receiving antenna.
- Increase the separation between the equipment and receiver.
- Connect the equipment into an outlet on a circuit different from that to which the receiver is connected.
- Consult the dealer or an experienced radio/TV technician for help.

You are cautioned that any changes or modifications not expressly approved in this manual could void your authority to operate this equipment.

For the customers in Australia

The supply cord of the AC power adaptor cannot be replaced; if the cord is damaged, the AC power adaptor should be discarded.

For the customers not in Poland

The (B) mark on the unit is valid only for products marketed in Poland.

For the customers not in Europe

The CE mark on the unit is valid only for products marketed in the European Union.

For the customers not in Russia

This mark on the unit and package is valid only for products marketed in Russia.

A946

Playing a CD in a car

You can use your player in a car as illustrated below.



To connect your player to a car cassette deck, you need the following accessories:

- Car connecting pack
- Car battery cord

or,

- Mount kit CPM-300PC (Mount plate + Car connecting pack + Car battery cord)
- Car battery cord with car connecting pack DCC-E26CP

Refer to the instruction manual of each accessory for details.

When you use the CPM-300PC mount kit/CPM-300P mount plate

Attach the car mount adaptor supplied to the CPM-300PC/300P before installing the player.

Notes

- Do not put the player on the dashboard.
- Do not leave the player in a car parked under sunlight.
- If the sound is distorted, set MEGA BASS to OFF.
- Use a Sony car connecting pack for reducing noise.
- Use only the car battery cord listed in the optional accessories. If you use any other car battery cord, smoke, fire or malfunction may occur.

Switched ignition function (when using the car battery cord)

With this feature, your player stops automatically when you turn off the engine of the car. (This function is not possible with some cars depending on the model.)

▶Power Sources

Using dry batteries

- Open the lid of the battery compartment.

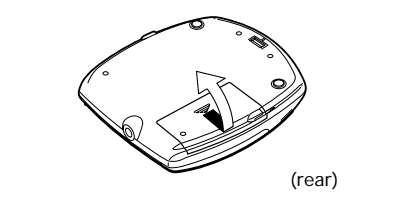

- Insert two LR6 (size AA) alkaline batteries by matching the ⊕ and ⊖ to the diagram inside the battery compartment and close the lid.

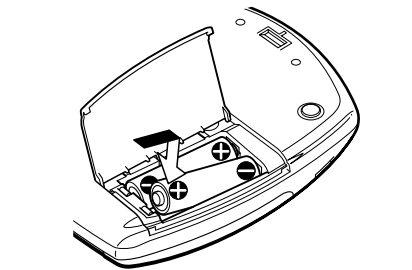

Note

- Do not use manganese batteries for this player.

To take out the dry batteries

Pull the ⊕ side of the battery as shown.

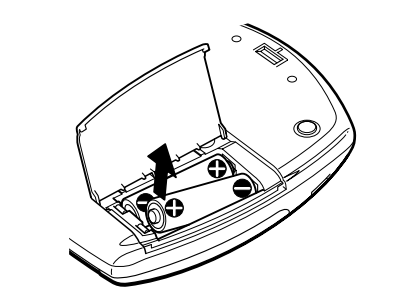

When to replace the dry batteries

If the ⏻ indication appears in the display and the sound becomes inaudible, replace all the batteries with new ones, because the batteries become weak.

Notes

- Do not charge the dry batteries.
- Do not mix new batteries with old ones.
- Do not use different types of batteries together.
- When the batteries are not to be used for a long time, remove them.
- If the battery leakage occurs, wipe off any deposit in the battery compartment, and install new batteries.

Battery life (approx. hours)(EIAJ*)

Battery life varies depending on how the player is used.

Two Sony alkaline batteries LR6SG	10
-----------------------------------	----

*Measured value by the standard of EIAJ (Electronic Industries Association of Japan). (When the unit is used on a flat and stable place.)

How to attach the battery compartment lid

If the battery compartment lid is detached by an accidental drop, excessive force, etc., attach it as illustrated in the numbered order.

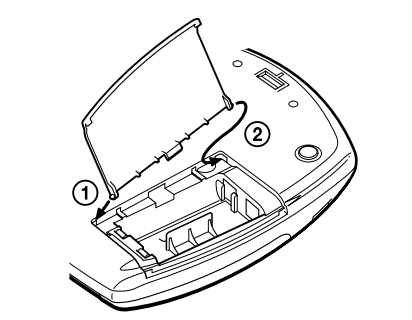

▶Additional Information

Precautions

On safety

- Should any solid objects or liquid fall into the unit, unplug it and have it checked by qualified personnel before operating it any further.
- Do not put any foreign objects in the DC IN 4.5 V (external power input) jack.

On power sources

- When you are not using the player for a long time, disconnect all power sources from the player.

On the AC power adaptor

- Use only the supplied AC power adaptor. If your player is not supplied with it, use AC-E45HG AC power adaptor. Do not use any other AC power adaptor.

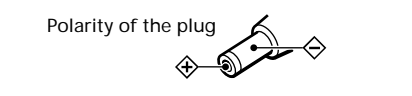

- To unplug the AC power adaptor from the wall outlet, grasp the adaptor itself, do not pull its cord.

On dry batteries

- Do not throw the batteries into fire.
- Do not carry the dry batteries with coins or other metallic objects. It can generate heat if the positive and negative terminals of the battery are accidentally contacted by a metallic object.

On the player

- Keep the lens of the player clean and do not touch it. If you do so, the lens may be damaged and the player will not operate properly.
- Do not put any heavy object on top of the player. The unit and the CD may be damaged.
- Do not leave the player in a location near heat sources, or in a place subject to direct sunlight, excessive dust or sand, moisture, rain, mechanical shock, unlevelled surface, or in a car with its windows closed.
- If the player causes interference to radio or television reception, turn off the player or move it away from the radio or television.
- Do not wrap the player in a cloth or blanket during use as it may cause malfunction or serious accidents.

On headphones/earphones

Road safety

Do not use headphones/earphones while driving, cycling, or operating any motorized vehicle. It may create a traffic hazard and is illegal in some areas. It can also be potentially dangerous to play your headsets at high volume while walking, especially at pedestrian crossings. You should exercise extreme caution or discontinue use in potentially hazardous situations.

Preventing hearing damage

Avoid using headphones/earphones at high volume. Hearing experts advise against continuous, loud and extended play. If you experience a ringing in your ears, reduce volume or discontinue use.

Caring for others

Keep the volume at a moderate level. This will allow you to hear outside sounds and to be considerate to the people around you.

Maintenance

To clean the lens

Clean the lens with a lens cleaning kit KK-DM1.

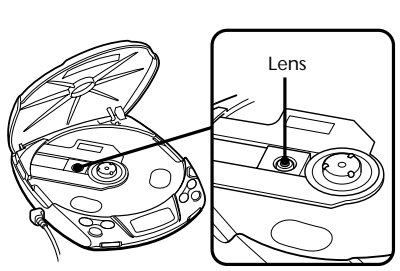

To clean the casing

Use a soft cloth slightly moistened in water or a mild detergent solution. Do not use alcohol, benzine or thinner.

Troubleshooting

Should any problem persist after you have made these checks, consult your nearest Sony dealer.

The CD does not play or “no dl SC” appears in the display though a CD is placed in the unit.

- The CD is dirty or defective.
- Insert the CD with the label side up.
- Moisture condensation has occurred. Leave the unit aside for several hours until the moisture evaporates.
- The lens is dirty.
- Close the lid of the unit and the battery compartment firmly.
- Make sure the batteries are inserted correctly.
- Connect the AC power adaptor to a wall outlet securely.
- Dry batteries are used up. Replace dry batteries with new ones.

When you press ►, “00” appears in the display for a moment, and disappears. The CD does not play.

- Dry batteries are used up. Replace dry batteries with new ones.

No sound, or noise is heard.

- Connect the plugs firmly.
- Plugs are dirty. Clean the plugs with a dry soft cloth periodically.

“Hl dc l n” appears in the display.

- Use only the supplied AC power adaptor or AC power adaptor AC-E45HG (not supplied).

“Hol d” appears in the display when you press a button.

- The buttons are locked. Slide HOLD back.

The ⏻ indication appears in the display when you press a button.

- The dry batteries are used up. Replace them with new ones.

The battery life is short.

- Manganese batteries are used. Use alkaline batteries.
- Replace the batteries with new ones.

The rechargeable battery cannot be charged in the battery compartment of this player.

- This player does not have the function to charge the rechargeable battery.

The volume is limited to a certain level even if you attempt to turn it up.

- AVLS function keeps down the volume. Hold down MENU until “AVLS” disappears from the display.

You cannot use the AMS function nor enjoy the various playing modes such as REPEAT 1, REPEAT and REPEAT SHUFFLE.

- If you use the following discs, the AMS or play mode function may not operate well:
 - a disc where the pause between the tracks is extremely short,
 - a disc that has only one track,
 - a disc that has more than 95 tracks.

You cannot operate the ◀◀/▶▶ buttons.

- After starting play, you cannot operate these buttons until the elapsed time appears in the display. Press them after the time indication appears in the display.

Play does not start right away.

- It may take longer to start playing the disc that has a lot of tracks. Wait for a while.

Specifications

CD player

System

- Compact disc digital audio system
- Laser diode properties**
 - Material: GaAlAs
 - Wavelength: λ = 780 nm
 - Emission duration: Continuous
 - Laser output: Less than 44.6 μW (This output is the value measured at a distance of 200 mm from the objective lens surface on the optical pick-up block with 7 mm aperture.)

Error correction

- Sony Super Strategy Cross Interleave Reed Solomon Code

D-A conversion

- 1-bit quartz time-axis control
- Frequency response**
 - 20 - 20,000 Hz 1⁄3 dB (measured by EIAJ CP-307)

Output (at 4.5 V input level)

- Headphones (stereo minijack)
 - Approx. 5 mW + approx. 5 mW at 16 ohms (Approx. 2 mW + approx. 2 mW at 16 ohms*)
 - *For the customers in France

General

Power requirements

For the area code of the model you purchased, check the upper left side of the bar code on the package.

- Two LR6 (size AA) batteries: 3 V DC
- AC power adaptor (DC IN 4.5 V jack):
 - U2/CA2/E92/MX2 model: 120 V, 60 Hz
 - CED/CEX/EE/EE1/E13/G5/G6/G7/G8/CE7 model: 220 - 230 V, 50/60 Hz
 - CEK model: 230 - 240 V, 50 Hz
 - EA3 model: 110 - 240 V, 50/60 Hz
 - AU2 model: 240 V, 50 Hz
 - JE.W/E33 model: 100 - 240 V, 50/60 Hz
 - HK2 model: 220 V, 50/60 Hz
 - CN2/AR1 model: 220 V, 50 Hz
- Sony CPM-300P mount plate for use on car battery: 4.5 V DC

Dimensions (w/h/d) (without projecting parts and controls)

- Approx. 131×28×148 mm (5 ¹⁄4×1 ¹⁄2×5 ⁵⁄16 in.)

Mass

- Approx. 220 g (7.8 oz)

Operating temperature

- 5°C - 35°C (41°F - 95°F)

Supplied accessories

For the area code of the model you purchased, check the upper left side of the bar code on the package.

- D-191
 - AC power adaptor (1)
 - Headphones (1)*1
 - Earphones (1)*2
 - Connecting cord (Phono plug × 2 ↔ stereo miniplug) (1)*3
 - AC plug adaptor (1)*4
 - *1Supplied with U2 and CA models
 - *2Not supplied with U2 and CA models
 - *3Not supplied with U2 model
 - *4Supplied with E33, E13, and EA3 models
- D-192CK
 - AC power adaptor (1)
 - Headphones (1)*1
 - Earphones (1)*2
 - Connecting cord (Phono plug × 2 ↔ stereo miniplug) (1)*2
 - Car connecting pack (1)
 - Car battery cord (1)
 - Mount plate (1)
 - Velcro tape (2)
 - Spare fuse (1)
 - Spiral tube (1)
 - AC plug adaptor (1)*3
 - *1Supplied with U2 model
 - *2Not supplied with U2 model
 - *3Supplied with E33, E13, and EA3 models

Design and specifications are subject to change without notice.

For US customers

AC power adaptor supplied is not intended to be serviced. Should the AC power adaptor cease to function in its intended manner, during the warranty period, the adaptor should be returned to your nearest Sony Service Center or Sony Authorized Repair Center for replacement, or after warranty period, it should be discarded.

Optional accessories

- Mount plate CPM-300P
- Mount kit CPM-300PC
- Car connecting pack CPA-9
- Car battery cord with car connecting pack DCC-E26CP
- Car battery cord DCC-E245
- Active speaker system SRS-A21, SRS-A41, SRS-A71
- Connecting cord RK-G129HG, RK-G136HG
- AC power adaptor AC-E45HG
- Stereo headphones MDR-A44L, MDR-301LP, MDR-E848LP, MDR-35*
- *When using optional headphones, use only headphones with stereo miniplugs. You cannot use headphones with micro plugs.

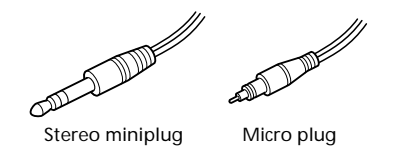

Your dealer may not handle some of the above listed accessories. Please ask the dealer for detailed information about the accessories in your country.