

Personal Audio System

ZS-PS20CP

©2008 Sony Corporation Printed in China

Operating Instructions **GB**

<http://www.sony.net/>

WARNING

To reduce the risk of fire or electric shock, do not expose this apparatus to rain or moisture.

To reduce the risk of electrical shock, do not open the cabinet. Refer servicing to qualified personnel only.

To reduce the risk of fire, do not cover the ventilation of the apparatus with newspapers, tablecloths, curtains, etc. And do not place lighted candles on the apparatus.

To reduce the risk of fire or electric shock, do not expose this apparatus to dripping or splashing, and do not place objects filled with liquids, such as vases, on the apparatus.

As the main plug is used to disconnect the unit from the mains, connect the unit to an easily accessible AC outlet. Should you notice an abnormality in the unit, disconnect the main plug from the AC outlet immediately.

Do not install the appliance in a confined space, such as a bookcase or built-in cabinet.

Do not expose the batteries (battery pack or batteries installed) to excessive heat such as sunshine, fire or the like for a long time.

Excessive sound pressure from earphones and headphones can cause hearing loss.

MPEG Layer-3 audio coding technology and patents licensed from Fraunhofer IIS and Thomson.

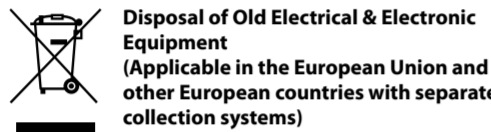

Disposal of Old Electrical & Electronic Equipment (Applicable in the European Union and other European countries with separate collection systems)

This symbol on the product or on its packaging indicates that this product shall not be treated as household waste. Instead it shall be handed over to the applicable collection point for the recycling of electrical and electronic equipment. By ensuring this product is disposed of correctly, you will help prevent potential negative consequences for the environment and human health, which could otherwise be caused by inappropriate waste handling of this product. The recycling of materials will help to conserve natural resources. For more detailed information about recycling of this product, please contact your local Civic Office, your household waste disposal service or the shop where you purchased the product.

Applicable accessories: Remote control



Disposal of waste batteries (applicable in the European Union and other European countries with separate collection systems)

This symbol on the battery or on the packaging indicates that the battery provided with this product shall not be treated as household waste. By ensuring these batteries are disposed of correctly, you will help prevent potentially negative consequences for the environment and human health which could otherwise be caused by inappropriate waste handling of the battery. The recycling of the materials will help to conserve natural resources.

In case of products that for safety, performance or data integrity reasons require a permanent connection with an incorporated battery, this battery should be replaced by qualified service staff only. To ensure that the battery will be treated properly, hand over the product at end-of-life to the applicable collection point for the recycling of electrical and electronic equipment.

For all other batteries, please view the section on how to remove the battery from the product safely. Hand the battery over to the applicable collection point for the recycling of waste batteries.

For more detailed information about recycling of this product or battery, please contact your local Civic Office, your household waste disposal service or the shop where you purchased the product.

Notice for customers: the following information is only applicable to equipment sold in countries applying EU Directives

The manufacturer of this product is Sony Corporation, 1-7-1 Konan, Minato-ku, Tokyo, Japan. The Authorized Representative for EMC and product safety is Sony Deutschland GmbH, Hedelfinger Strasse 61, 70327 Stuttgart, Germany. For any service or guarantee matters please refer to the addresses given in separate service or guarantee documents.

Notes on DualDiscs

A DualDisc is a two sided disc product which mates DVD recorded material on one side with digital audio material on the other side. However, since the audio material side does not conform to the Compact Disc (CD) standard, playback on this product is not guaranteed.

Music discs encoded with copyright protection technologies

This product is designed to playback discs that conform to the Compact Disc (CD) standard. Recently, various music discs encoded with copyright protection technologies are marketed by some record companies. Please be aware that among those discs, there are some that do not conform to the CD standard and may not be playable by this product.

Basic Operations

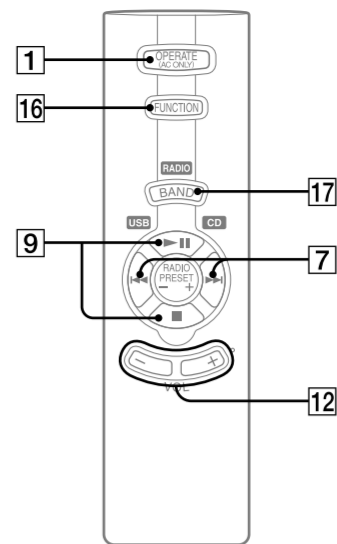
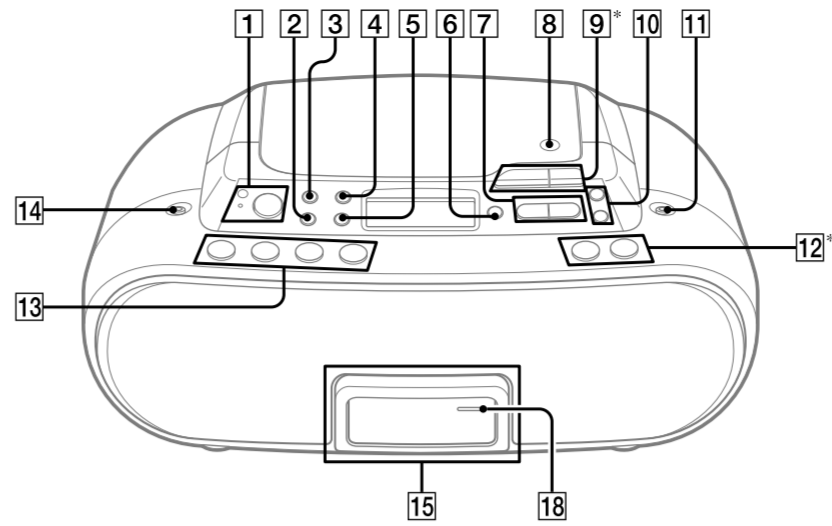

* VOLUME + (VOL + on the remote) **12** and **▶|| 9** on the unit have a tactile dot.

Before using the unit

About the operating voltage

The unit's operating voltage is shown on the bottom of the unit. For changing the AM tuning interval, radio frequency range, and AC operation, check the operating voltage of your unit.

To turn on/off the power

Press OPERATE **1**.

To adjust the volume

Press VOLUME +, - (VOL +, - on the remote) **12**.

To listen through headphones

Connect the headphones to the ϕ (headphones) jack **14**.

To reinforce the bass sound

Press MEGA BASS **2** on the unit. "MEGA BASS" appears in the display. To return to normal sound, press the button again.

Playing a CD/MP3/WMA disc

- Press CD **13** on the unit. (On the remote, press OPERATE **1**) and then press FUNCTION **16** repeatedly until "CD" appears in the display.
- Press \blacktriangle PUSH OPEN/CLOSE **8** on the unit, and place a disc with the label side up in the CD compartment. To close the CD compartment, press \blacktriangle PUSH OPEN/CLOSE **8** on the unit.

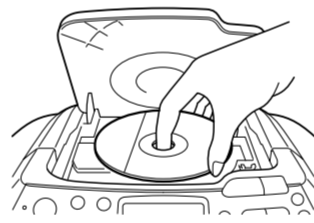

- Press **▶|| 9**. The unit plays all the tracks/MP3/WMA files once. When you place MP3/WMA discs, "MP3" or "WMA" appears in the display after the unit reads the file information.

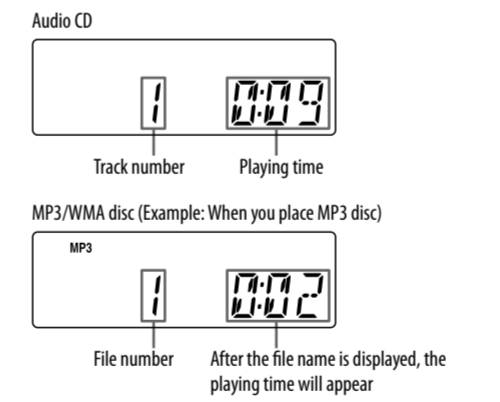

To	Press
Pause playback	▶ 9 . To resume play, press it again.
Stop playback	■ 9 .
Go to the next track/MP3/WMA file	▶▶ 7 .
Go back to the previous track/MP3/WMA file	◀◀ 7 .
Select a folder on an MP3/WMA disc	\square + on the unit to go forward and \square - to go backward 10 .
Locate a point while listening to the sound	▶▶▶ 7 (forward) or ◀◀◀ 7 (backward) on the unit while playing and hold it until you find the point.
Locate a point while observing the display	▶▶▶ 7 (forward) or ◀◀◀ 7 (backward) on the unit in pause and hold it until you find the point.
Remove the CD	\blacktriangle PUSH OPEN/CLOSE 8 .

Tips

- Playback starts from the track/MP3/WMA file last stopped playing (Resume play). During stop, the track/MP3/WMA file number to be played is displayed.
- To cancel resume play (to start play from the beginning of the first track/MP3/WMA file), press \blacksquare **9** or open the CD compartment in stop mode.

Note

You cannot locate a specific track/MP3/WMA file if "SHUF" or "PGM" is lit in the display. Turn off the indication by pressing MODE **4**.

Example of folder structure and playing order

The playing order of folders and files is as follows:

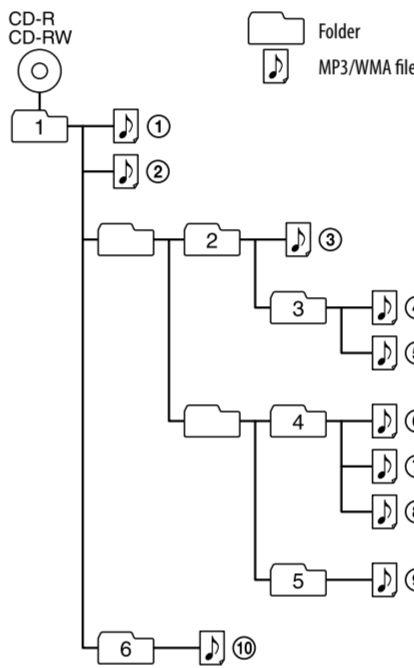

Notes on MP3/WMA discs

- When a disc is inserted, the unit reads all the files on that disc. During this time, "READING" is displayed. If there are many folders or non-MP3/WMA files on the disc, it may take a long time for play to begin or for the next MP3/WMA file to start play. Do not save unnecessary folders or files other than MP3/WMA ones on a disc to be used for MP3/WMA listening.
- A folder that does not include an MP3/WMA file is skipped.
- Maximum number of files: 511
- Maximum number of folders: 150
- Maximum directory steps: 8
- Folder names and file names can be displayed with up to 32 characters.
- The characters A - Z, a - z, 0 - 9, and $_$ can be displayed on this unit. Other characters are displayed as " _".
- This unit conforms to Version 1.1 of the ID3 tag format. If the file has the ID3 tag information, "song title", "artist name", and "album name" can be displayed.
- When naming, be sure to add the file extension ".mp3" or ".wma" to the file name.
- If you put the extension ".mp3" or ".wma" to a file other than an MP3/WMA file, the unit cannot recognize the file properly and will generate random noise that could damage your speakers.
- The file name does not correspond to the ID3 tag.
- If an MP3/WMA disc that contains over 511 files is played, the disc may not be played as shown in the illustration.

Listening to the radio

- Press RADIO **13** on the unit (BAND **17** on the remote) repeatedly. Each time you press the button, the indication changes as follows: "FM" \rightarrow "AM".
- Hold down TUNE + or - **10** until the frequency digits begin to change in the display. The unit automatically scans the radio frequencies and stops when it finds a clear station. If you cannot tune in a station, press TUNE + or - **10** repeatedly to change the frequency step by step. When an FM stereo broadcast is received, "ST" appears.

Tip

If the FM broadcast is noisy, press MODE **4** until "MONO" appears in the display and the radio will play in monaural.

Changing the AM tuning interval

If you need to change the AM tuning interval, do the following:

- Press RADIO **13** on the unit until "AM" is displayed.
- Press DISPLAY/ENTER **5** on the unit for 2 seconds.
- Press RADIO **13** on the unit for 2 seconds. "9k STEP" or "10k STEP" flashes.
- Press PRESET + or - **7** on the unit to select "9k STEP" for 9 kHz interval or "10k STEP" for 10 kHz interval.
- Press DISPLAY/ENTER **5** on the unit. After changing the tuning interval, you need to reset your preset AM radio stations.

Opening/closing the Sliding Tray

Connecting a USB device

- Press **15**. The Sliding Tray **15** is ejected.
- Connect your USB device to the \leftrightarrow (USB) port **15**.

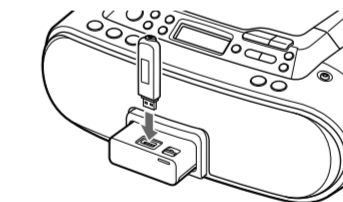

Tip

A digital music player is charged automatically in the USB mode when connected to the \leftrightarrow (USB) port **15**.

Closing the Sliding Tray

- Remove the USB device (see "Listening to music of a USB device").
- Slide the Lock **19** as indicated by the arrow.

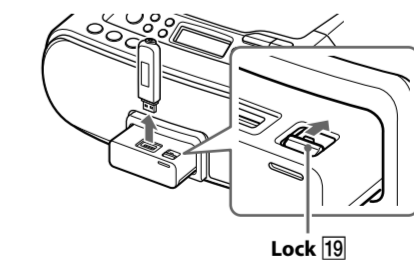

- Push the Sliding Tray **15** into the unit until it clicks.

Notes

- Do not carry the unit with a USB device inserted to the connector. Doing so may cause a malfunction.
- Be sure to store the Sliding Tray **15** before moving the unit.

Listening to music of a USB device

You can listen to music stored on an optional USB device (digital music player or USB storage media). Music files in WMA and MP3 format* can be played on this unit. See "Playable USB devices" on the back page for a list of USB devices that can be connected to this unit. * Files with copyright protection (Digital Rights Management) cannot be played on this unit.

- Press USB **13** on the unit.
- Connect the USB device to the \leftrightarrow (USB) port **15** (See "Connecting a USB device"). "USB MEMORY" appears in the display.
- Press **▶|| 9**. The unit starts playing.

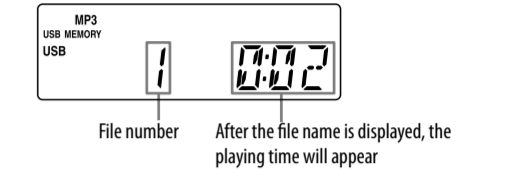

- Press VOLUME + or - (or VOL + or - on the remote) **12** to adjust the volume.

Other operations

To	Press
Pause playback	▶ 9 . To resume play, press the button again*.
Stop playback	■ 9 .
Select a folder	\square + or - 10 .
Select a file	◀◀ or ▶▶ 7 .
Find a point in a file	Hold down ◀◀ or ▶▶ 7 during playback, and release the button at the desired point.
Select Repeat Play	REPEAT 6 on the unit repeatedly until \square or \square 1 appears.
Remove the USB device	Hold down ■ 9 until "NO DEV" appears, then remove the USB device.

* When playing a VBR MP3 file, the unit may resume playback from a different point.

Tips

- Playback starts from the MP3/WMA file you last stopped playing (Resume play). During stop, the MP3/WMA file number and the playing time to be played are displayed.
- To cancel resume play (to start play from the beginning of the first MP3/WMA file), press \blacksquare **9**.

Note

Always hold down **■ 9** and make sure that "NO DEV" appears before removing the USB device. Removing the USB device while "NO DEV" is not displayed may corrupt the data on the USB device or damage the USB device itself.

To change the play mode

Press MODE **4** repeatedly while the USB device is not playing. You can select Normal Play (all files on the USB device (or in the selected folder while \square lights up) one after another), Shuffle Play ("SHUF" or \square SHUF"), or Program Play ("PGM").

Notes on the USB device

- You cannot change the play mode during playback.
- Some time may be needed before playback starts when:
 - the folder structure is complex.
 - the USB device is close to capacity.
- When a USB device is connected, the unit reads all the files on the device. If there are many folders or files on the device, it may take a long time for the unit to finish reading them.
- Do not connect a USB device to the unit through a USB hub.
- For some USB devices, when an operation is performed on the USB device, there may be a delay before it is carried out on this unit.
- This unit may not support all the functions provided on the connected USB device.
- The playback order on this unit may differ from the playback order on the connected USB device.
- During playback, folders that contain no MP3/WMA files are skipped.
- This unit can play MP3 and WMA files that have the ".mp3" or ".wma" file extension.
- If there are files on the disc that have the ".mp3" or ".wma" file extension, but are not MP3/WMA files, the unit may produce noise or malfunction.
- A maximum of 999 MP3/WMA files and 255 folders can be contained on a single USB device. The maximum number of MP3/WMA files and folders may vary, depending on the file and folder structure.
- Compatibility with all MP3/WMA encoding/writing software, recording devices, and recording media cannot be guaranteed. If you use an incompatible USB device, sound skipping or noise may be produced, or the device may not play at all.

Connecting optional components

You can enjoy the sound from an optional component such as a portable digital music player through the speakers of this unit. Be sure to turn off the power of each component before making any connections. For details, refer to the instruction manual of the component to be connected.

- Connect the AUDIO IN jack **11** on the unit to the line output jack of the portable digital music player or other components using an audio connecting cable (not supplied).
- Turn the unit and the connected component on.
- Press AUDIO IN **13** and start playing sound on the connected component. The sound from the connected component is output from the speakers.

To connect the unit to a TV or VCR, use an extension cable (not supplied) with a stereo-mini jack on one end and two phono plugs on the other end.

Other Operations

Using the display

You can check information about the CD using the display.

Checking the information of an audio CD

To check the total track number and playing time of the CD

Press ■ [9] to stop the CD playback.

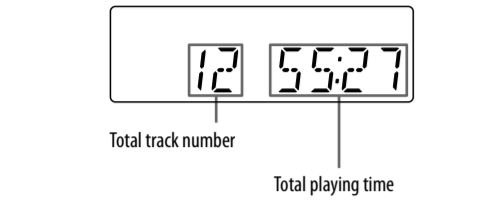

Checking the information of an MP3/WMA disc

To check the total folder number on the CD
Press ■ [9] to stop the CD playback.

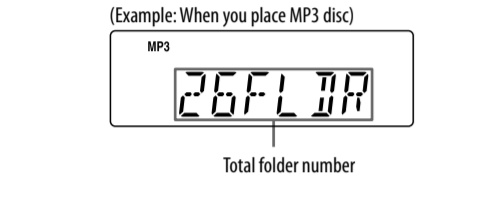

To check file information

Press DISPLAY/ENTER [5] on the unit while playing an MP3/WMA disc. The display changes as follows:

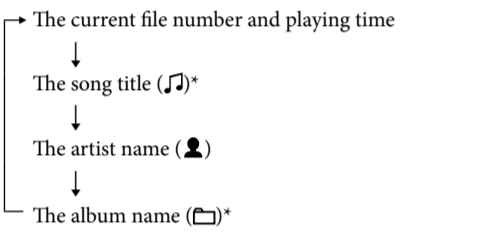

* If the file does not have ID3 information, file name or folder name appears in the display.

Playing tracks/MP3/WMA files repeatedly (Repeat Play)

You can play tracks/MP3/WMA files repeatedly in normal, shuffle or program play modes.

- Press CD [13] on the unit.
 - "CD" appears in the display.
- Proceed as follows:

To repeat	Do this
A single track/MP3/WMA file	<ol style="list-style-type: none">Press REPEAT [6] on the unit until ↺ "1" appears. Press ⏮ or ⏭ [7] to select the track/MP3/WMA file that you want to repeat. Press ▶⏮ [9].
All tracks/MP3/WMA files on the CD	<ol style="list-style-type: none">Press REPEAT [6] on the unit until ↺ "1" appears. Press ▶⏮ [9].
A selected folder (MP3/WMA disc only)	<ol style="list-style-type: none">Press MODE [4] until 📁 appears and then press REPEAT [6] until "REP" appears. Select the folder by pressing 📁 + or 📁 - [10]. Press ▶⏮ [9].

Tracks/MP3/WMA files in random order	<ol style="list-style-type: none">Start Shuffle Play (see "Playing tracks/MP3/WMA files in random order"). Press REPEAT [6] on the unit until ↺ appears. Press ▶⏮ [9].
--------------------------------------	--

MP3/WMA files in a selected folder in random order (MP3/WMA disc only)	<ol style="list-style-type: none">Start Folder Shufle Play (see "Playing tracks/MP3/WMA files in random order"). Press REPEAT [6] on the unit until ↺ appears. Press ▶⏮ [9].
Programed tracks/MP3/WMA files	<ol style="list-style-type: none">Program tracks/MP3/WMA files (see "Creating your own program"). Press REPEAT [6] on the unit until ↺ appears. Press ▶⏮ [9].

To cancel Repeat Play

Press REPEAT [6] on the unit until ↺ disappears from the display.

Playing tracks/MP3/WMA files in random order (Shuffle Play)

You can play tracks/MP3/WMA files in random order.

- Press CD [13] on the unit.
 - "CD" appears in the display.
- Press MODE [4] until "SHUF" appears in the display. When you select Folder Shuffle Play (MP3/WMA disc only), press MODE [4] on the unit until 📁 and "SHUF" appear in the display. Then press 📁 + or - [10] on the unit to select the folder you want.
- Press ▶⏮ [9] to start Shuffle Play.

To cancel Shuffle Play

Stop playing first. Then press MODE [4] until "SHUF" disappears from the display.

Tips

- During Shuffle Play, you cannot select the previous track/MP3/WMA file by pressing ⏮ [7].
- The resume function does not work during Shuffle Play.

Creating your own program (Program Play)

You can arrange the playing order of up to 25 tracks/MP3/WMA files on a CD.

- Press CD [13] on the unit.
 - "CD" appears in the display.
- Press MODE [4] until "PGM" appears in the display.
- Press ⏮ or ⏭ [7] to select the track/MP3/WMA file, and then press DISPLAY/ENTER [5] to add it to the program. Repeat to program other tracks in the order that you want.

After programming the first track, "STEP 1" appears, followed by selected track/MP3/WMA file. Each time you add a track/MP3/WMA file, a step number is added.

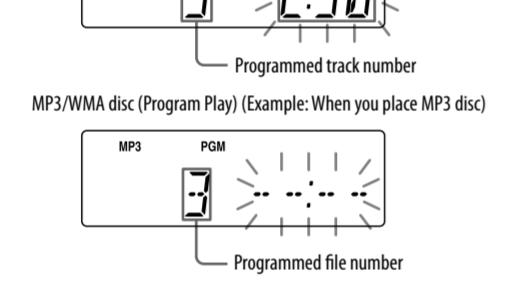
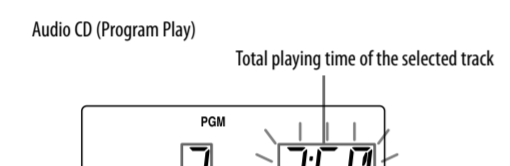

- Press ▶⏮ [9] to start Program Play.

To cancel Program Play

Stop playing first. Then press MODE [4] until "PGM" disappears from the display.

To clear the program you set

Press ■ [9]. "NO STEP" appears in the display for 2 seconds, and the same display information as when inserting a CD appears.

Tips

- You can play the same program again, since the program is saved, until you press ■ [9] or open the CD compartment.
- The resume function does not work during Program Play.

Presetting radio stations

You can store radio stations in unit's memory. You can preset up to 30 radio stations, 20 for FM and 10 for AM in any order.

- Press RADIO [13] repeatedly on the unit to select the band.
- Hold down RADIO [13] on the unit for 2 seconds until "AUTO" flashes in the display.
- Press DISPLAY/ENTER [5] on the unit. The stations are stored in memory from lower frequencies to higher ones.

If a station cannot be preset automatically

You may need to preset a station with a weak signal manually.

- Press RADIO [13] repeatedly on the unit to select the band.
- Tune in the station you want.
- Hold down DISPLAY/ENTER [5] on the unit for 2 seconds until the preset number flashes in the display.
- Press PRESET + or - [7] on the unit until the preset number you want for the station flashes in the display.
- Press DISPLAY/ENTER [5] on the unit. The new station replaces the old one.

Tip

The preset radio stations remain in memory even if you unplug the AC power cord or remove the batteries.

Precautions

Playing preset radio stations

- Press RADIO [13] repeatedly on the unit to select the band.
- Press PRESET + or - [7] on the unit to tune in the stored station.

Falling asleep to music

- Play the music source you want.
- Press SLEEP [3] to display "SLEEP".
- Press SLEEP [3] to select the minutes until the unit goes off automatically.

Each time you press the button, the indication changes as follows:

"AUTO" → "60MIN" → "30MIN" → "20MIN" → "10MIN" → "OFF".

* When you select "AUTO", the CD and USB stops playing in 90 minutes at most and the unit goes off automatically. When you are listening to the radio and audio in, the unit goes off in 90 minutes.

When the preset time has passed, the unit goes off automatically.

If 4 seconds pass after pressing SLEEP [3], the currently displayed time option is entered.

To cancel the sleep function

Press OPERATE [1] to turn off the power, or press SLEEP [3] repeatedly to set the sleep timer to "OFF" in step 3.

Playable USB devices

You can use the following Sony USB devices on this unit. Other USB devices are not playable on this unit.

Verified Sony digital music players (as of January 2008)

Product name	Model name
Walkman [®]	NWD-B103 / B103F / B105 / B105F
	NWZ-A815/A816/A818
	NWZ-S515/S516/S615F/S616F/S618F/S716F

Check the websites below for the latest information about compatible devices.

For customers in Europe:
<http://support.sony-europe.com/>
For customers in Latin America:
<http://www.sony-latin.com/pa/info>
For customers in Asia and Oceania:
<http://www.sony-asia.com/section/support>

Notes

- When formatting the above models, be sure to format using the model itself or the dedicated formatting software for that model.
- Do not use any other than these USB devices. Operation of models not listed here is not guaranteed.
- Operation may not always be ensured even when using these USB devices.
- Some of these USB devices may not be available for purchase in certain areas.
- Playback of Windows Media Audio/AAC files with copyright protection is not supported.
- Files downloaded from a music download website may not be played.
- Connection through a hub is not supported.

Troubleshooting

General

The power is not on.

- Connect the AC power cord to the wall outlet securely.
- Make sure the batteries are inserted correctly.
- Replace all the batteries with new ones if they are weak.
- You cannot turn on the unit with the remote when you operate the unit on batteries.

There is no audio.

- Unplug the headphones when listening through speakers.

Noise is heard.

- Someone is using a portable telephone or other equipment that emits radio waves near the unit.
 - Move the portable telephone, etc., away from the unit.

CD/MP3/WMA player

The CD does not play or "NO DISC" is displayed even when a CD is in place.

- Place the CD with the label surface up.
- Clean the CD.
- Take out the CD and leave the CD compartment open for about an hour to dry moisture condensation.
- The CD-R/CD-RW is blank.
- There is a problem with the quality of the CD-R/CD-RW, recording device or application software.
- Replace all the batteries with new ones if they are weak.

The sound drops out.

- Reduce the volume.
- Clean the CD, or replace it if the CD is badly damaged.
- Place the unit in a location free from vibration.
- Clean the lens with a commercially available blower.
- The sound may drop out or noise may be heard when using poor quality CD-Rs/CD-RWs or if there is a problem with the recording device or application software.

Starting playback takes more time than usual.

- The following discs take a longer time to start playback.
 - a disc recorded with a complicated tree structure.
 - a disc that has not been finalized (a disc to which data can be added).
 - a disc that has many folders or non-MP3/WMA files.

Radio

Reception is poor.

- Reorient the antenna to improve FM reception.

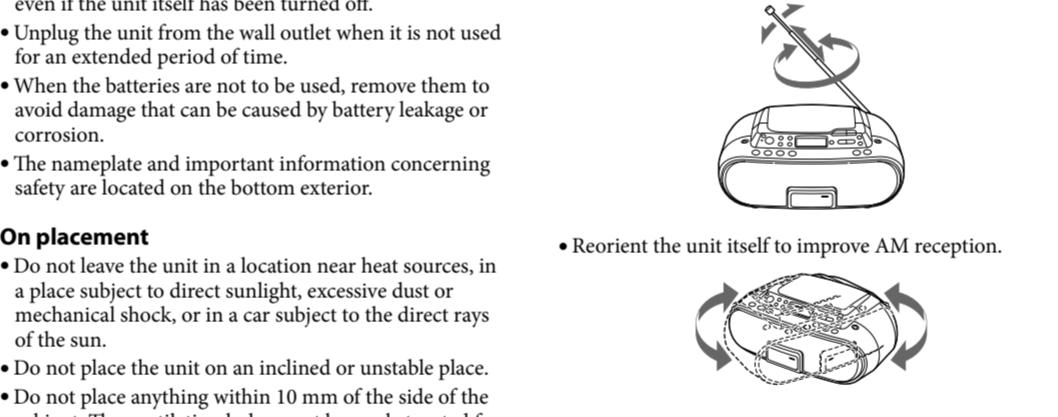

The audio is weak or has poor quality.

- Replace all the batteries with new ones if they are weak.
- Move the unit away from the TV.
- If you are using the remote while listening to AM radio, noise may be heard.

The picture of your TV becomes unstable.

- If you are listening to an FM program near the TV with an indoor antenna, move the unit away from the TV.

Cleaning the cabinet

- Clean the cabinet, panel and controls with a soft cloth slightly moistened with a mild detergent solution. Do not use any type of abrasive pad, scouring powder, or solvent, such as alcohol or benzine.

If you have any questions or problems concerning your unit, please consult your nearest Sony dealer.

USB device

Are you using a compatible USB device?

- If you connect an incompatible USB device, the following problems may occur. See "Playable USB devices" for a list of devices that are supported.
 - The USB device is not recognized.
 - File or folder names are not displayed on this unit.
 - Playback is not possible.
 - The sound skips.
 - There is noise.
 - The sound output is distorted.

"OVER CURRENT" appears.

- An abnormal level has been detected in the electrical current from the ⚡ (USB) port [15]. Turn off the unit and remove the USB device from the ⚡ (USB) port [15]. Make sure there is no problem with the USB device. If this message persists, contact your nearest Sony dealer.

There is no sound.

- The USB device is not connected correctly. Turn off the unit and reconnect the USB device. Then turn on the unit and check whether the "USB MEMORY" lights up or not in the display.

There is noise, skipping, or distorted sound.

- Turn off the unit and reconnect the USB device. Then turn on the unit again.
- The music data itself contains noise, or the sound is distorted. Noise may have entered during the recording process. Delete the file and try recording it again.

The USB device cannot be connected to the ⚡ (USB) port [15].

- The connector on the USB device or USB cable was not correctly oriented when the connection was attempted. Connect the connector on the USB device or USB cable in the correct orientation.

"READING" is displayed for an extended time, or it takes a long time before playback starts.

- The reading process can take a long time in the following cases:
 - There are many folders or files on the USB device.
 - The file structure is extremely complex.
 - The memory is almost full.
 - The internal memory is fragmented.
- To avoid the above problems, we recommend that you adhere to the following guidelines:
 - Keep the total number of folders on USB device to 100 or less
 - Keep the total number of files per folder to 100 or less.

Erroneous display

- The data stored on the USB device may be corrupted. Send the music data to the USB device again.
- This unit can display only numbers and letters of the alphabet. Other characters will not be displayed correctly.

The USB device is not recognized.

- Turn off the unit and reconnect the USB device, then turn on the unit.
- Connect the supported USB device (See "Playable USB devices" (on this page) for the supported device types.).
- The USB device does not work properly. Refer to the USB device operation manual for details on how to deal with this problem. If the problem persists, contact your nearest Sony dealer.

Play does not start.

- Turn off the unit and reconnect the USB device.
- Connect a USB device that this unit can play (see "Playable USB devices").

Play does not start from the first track.

- Set the play mode to Normal Play.

MP3/WMA files cannot be played back.

- The MP3/WMA files do not have the ".mp3" or ".wma" extension.
- The data was not stored in the MP3/WMA format.
- The USB storage device uses a file system other than FAT16 or FAT32.*
- The USB storage device is partitioned. Only the MP3/WMA files in the first partition can be played.
- Playback is possible up to 8 levels.
- The number of folders exceeds 255.
- The number of files exceeds 999.
- The files are encrypted or protected by passwords.

* This unit supports FAT16 and FAT32, but some USB storage media may not support both file systems. For details, refer to the operation manual of the USB storage device in question or contact the manufacturer.

Remote

The remote does not function.

- Replace all the batteries in the remote with new ones if they are weak.
- Make sure that you are pointing the remote at the remote sensor on the unit.
- Remove any obstacles in the path of the remote and the unit.
- Make sure the remote sensor is not exposed to strong light such as direct sunlight or fluorescent lamp light.
- Move closer to the unit when using the remote.

After trying the remedies, if you still have problems, unplug the AC power cord or remove all the batteries. After all the indications in the display disappear, plug the AC power cord or insert the batteries again. If the problem persists, please consult your nearest Sony dealer.