

34 E basicMove Art. 4032

- 
- D** **Gebrauchsanweisung**  
Elektro-Rasenmäher
- 
- GB** **Operating Instructions**  
Electric Lawnmower
- 
- F** **Mode d'emploi**  
Tondeuse électrique
- 
- NL** **Gebruiksaanwijzing**  
Elektrische grasmaaier
- 
- S** **Bruksanvisning**  
Elektrisk gräsklippare
- 
- I** **Istruzioni per l'uso**  
Rasaerba elettrico
- 
- E** **Manual de instrucciones**  
Cortacésped eléctrico
- 
- P** **Instruções de utilização**  
Máquina de cortar relva eléctrica
- 
- DK** **Brugsanvisning**  
Elektrisk plæneklipper

# GARDENA Electric Lawnmower 34 E basicMove

Welcome to the Garden with GARDENA...



Please read these operating instructions carefully and observe the notes given. Use these operating instructions to familiarise yourself with the electric lawnmower, its proper use and the notes on safety.



For safety reasons, children under the age of 16 and people not familiar with these operating instructions must not use this electric lawnmower.

→ Please keep these operating instructions in a safe place.

## Contents

1. Where to Use Your GARDENA Electric Lawnmower	11
2. Safety instructions	11
3. Assembly	13
4. Operation	14
5. Storage	16
6. Maintenance	16
7. Trouble-Shooting	16
8. Technical Data	18
9. Warranty/ Service	18

## 1. Where to Use Your GARDENA Electric Lawnmower

### Correct use

The GARDENA electric lawnmower is designed for cutting lawns in and around the garden.

Do not use the mower on a slope steeper than 20° maximum.

### Please note



To prevent injury, the electric lawnmower must not be used for trimming bushes, hedges, shrubs, for cutting and pruning of climbers or grass on roofs or in balcony boxes. In addition, the electric lawnmower must not be used for chopping up branches, twigs or for levelling irregularities in the soil.

## 2. Safety instructions

→ Please read the notes on safety on the electric lawnmower.



### Warning!

→ Please read the operating instructions before using the mower!



### Danger!

→ Cutting mechanism can cause injuries!



### Danger!

Risk of injury!

→ Keep bystanders away!



→ Unplug from the mains before maintenance or if the mains lead is damaged.

→ Keep the connection cable away from the mower.

### **Check each time you use the mower:**

Inspect the mower each time before you use it. Do not use the mower if the safety devices (switch handle, protective cover, cable strain relief, start button, grassbox) and/or the cutting mechanism are damaged or worn.

Replace damaged or worn parts. Never disable safety devices.

Check the grass to be cut before you start work. Remove any foreign bodies present (e.g. stones, branches).

Check the cutting tool for damage regularly and have it professionally repaired if necessary.

### **Operation:**

This electric lawnmower can cause serious injuries!

You are responsible for the safety of the working area.

Do not tilt the mower on its side whilst using it.

Never lift or carry the mower with the motor running.

Only use the electric lawnmower for the purposes specified in these instructions.

Wear sturdy shoes and long trousers to protect your legs.

Keep your fingers and feet away from the cutting blade and the cutting path.

Make sure you always take up a safe and stable stance whilst working, especially on slopes.

Be particularly careful if you change direction on a slope.

Be careful when going backwards.

Risk of stumbling!

Look out for foreign bodies when working (e. g. stones).

Do not let the handle fall forwards freely when folding it up.

### **Interruptions of work:**

Never leave the electric lawnmower unattended at the working area.

If you interrupt your work store the unit in a safe place.

Disconnect the mains plug!

When you interrupt work in order to go to another working area, always switch off the electric electric lawnmower during transport.

### **Environmental influences:**

Only work when visibility is good.

Familiarise yourself with the surroundings of your working area. Check for possible risks which might be not audible due to the noise of the machine.

Make sure that there are no other people (especially children) or animals anywhere near the working area.

If you do strike an obstacle when working, release the switch handle, **pull out the mains plug** and remove the obstacle.

Check the mower for damage and have it repaired if necessary.

Do not use the electric lawnmower if it is raining or in moist, wet conditions.

Please observe any local restrictions or noise levels.

### **Electrical safety:**



**DANGER!**  
**Electric shock!**

**If the insulation is damaged on the screw fastening the blade in position, this must be replaced by GARDENA Service or a specialist dealer authorised by GARDENA.**

The electric electric lawnmower must only be operated with an undamaged electric cable. If the electric cable or the extension cable is damaged disconnect the mains plug immediately.

The connection cable must be checked regularly for signs of damage and ageing (e.g. cracks).

The cable strain relief on the plug switch must be used (see 4. Operation).

Do not pull on the cable which is attached to the side of the upright.

The cable strain relief on the steering upright must be used (see 3 Fitting the cable clip).

Do not use the electric lawnmower close to swimming pools or garden ponds.

For portable units, which are used outdoors, we recommend to use a residual-current device having a residual-current rating  $\leq 30$  mA. In Switzerland use of a residual-current device is obligatory.

The socket of an extension cable should be water-proof and the connection sockets for extension cables must be made of rubber or be encased in rubber.

Only use permitted extension cables.

Ask your electrician.

Keep the extension cable away from the area you are cutting.

The mains voltage and the equipment voltage stated on the type plate must be the same. If extension cables are used, these must comply with the minimum cross-sections in the table below:

Voltage	Cable length	Cross-section
220-240V/50Hz	Up to 20 m	1.5 mm <sup>2</sup>
220-240V/50Hz	20 - 50 m	2.5 mm <sup>2</sup>

A brief voltage dip may occur when you switch on your electric lawnmower (due to conditions of the power supply) that may affect other devices (e.g. a lamp may flicker).

This problem should not occur with supply impedances of  $Z_{\max} < 0,46 \text{ Ohm}$ .

### 3. Assembly

#### Fitting the wheels:

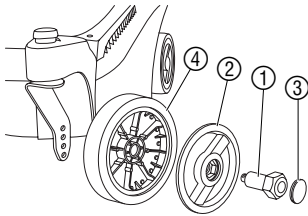

All 4 wheels must always be screwed in at the same cutting height (see 4 Operation "Setting the cutting height").

1. Insert screw ① through the bore in the hub cap ② and push the 6-sided head fully into the hub cap ②.  
**Use wheel hub with short bolt for the front wheel and wheel hub with long bolt for the rear wheel.**
2. Press covering cap ③ into the hub cap ② until it snaps in place.
3. Insert screw ① through the wheel ④ and screw the wheel ④ firmly in place by hand at the side and ensure it is securely located. *Screw in the small wheels (13 cm diameter) at the front and the large wheels (16 cm diameter) at the rear.*

#### Fit the upright:

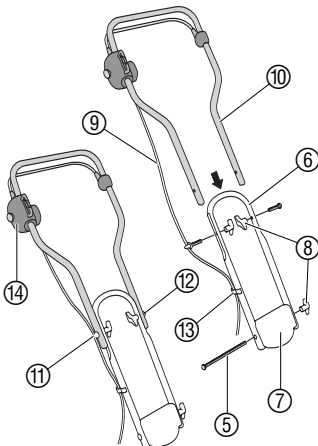

The upper part of the upright is preassembled on the 34 E basicMove lawnmower.

1. Insert long bolt ⑤ through the lower part of the upright ⑥ and the upright holder ⑦ from the cable side.
2. Screw lower part of upright ⑥ firmly in position with the wing nut ⑧. During this process, the wing nut ⑧ must be on the opposite side to the cable ⑨.
3. Push upper part of upright ⑩ into the grooves in the side of the lower part of the upright ⑥ until the bores in the upper part ⑩ and lower part ⑥ of the upright match precisely.

Check positioning of the plug switch ⑭. The cable ⑨ must run along the side of the upright and must not cross over itself.

4. Push short bolt **with** cable guide ⑪ on the cable side from outside through the bore ⑩ in the upper part of the upright ⑩.
5. Push short bolt **without** cable guide ⑫ from outside through the bore in the upper part of the upright ⑩.
6. Place both wing nuts ⑧ on the bolts ⑪ / ⑫ and tighten firmly.
7. Press cable ⑨ into the short bolt **with** cable guide ⑪ and fasten to the lower part of the upright ⑥ with the cable clip ⑬.

### Fitting the grass box:

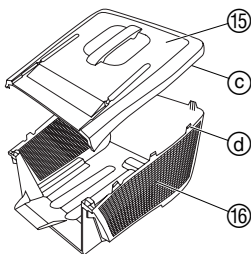

1. Place the box cover (15) on the grass box (16) from above in such a way that **ALL** the eyes (c) are positioned over the hooks (d).
2. Press the box cover (15) on to the grass box (16) until the hooks (d) engage securely.
3. Inspect: Check that all the hooks (d) are engaged securely.

## 4. Operation



### DANGER!

**Cutting tool can cause injuries!**

→ Wait until the cutting blade is stationary before undertaking any adjustment work, wear suitable work gloves and pull out the mains plug.

### Connecting to power supply:

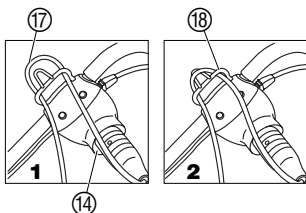

1. Push connector of the extension cable (17) on to the connector of the plug switch (14).
2. Draw a loop of the extension cable (17) through the cable strain relief device (18) **1** and suspend in position **2**.  
*This prevents inadvertent disconnection of the plug and socket connection.*
3. Insert extension cable (17) into a mains socket.

### Starting the mower:



**DANGER! Risk of injury if the mower does not switch off automatically!**

→ Do **not** remove or bypass the safety devices (start button, switch handle).

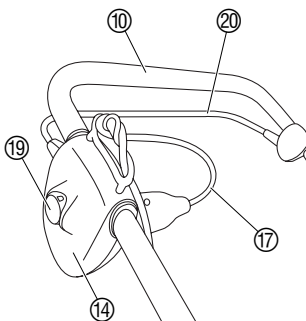

1. Place the lawnmower on flat grass surface.
2. Keep safety interlock (19) pressed down and pull starting lever (20) on the upper handle (10).  
*The lawnmower starts.*
3. Release safety interlock (19).
4. Only push the mower forwards and at walking pace.

**When in operation, the extension cable (17) must always be guided in the direction you are working and to the side of the area to be worked on. Always work away from the connection cable.**

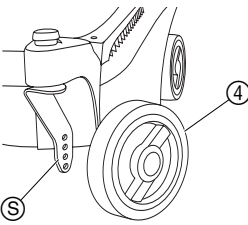
**Adjusting the cutting height:**

The cutting height can be adjusted from 2.0 to 6.5 cm in 1.5 cm-stages (4 positions).

→ Unscrew wheels (4) by hand and screw back in firmly at the cutting height required.

All 4 wheels (4) must always be screwed in at the same cutting height (see scale (5) on the back of the wheel mounting).

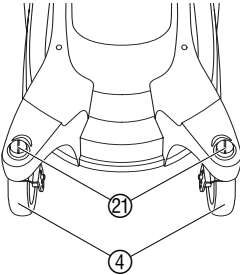
**Mowing on a slope:**

**⚠ To prevent the machine sliding down a slope, it is necessary to lock the front wheels before pushing the machine on to the slope.**

Do not use the mower on a slope steeper than 20° maximum.

1. Turn both red running wheel locks (21) either way by 90° (groove indicates direction of travel).

2. Bring front wheels (4) into straight ahead position until the lock (21) engages.

*The wheels are locked in the straight ahead position.*

After mowing the slope, the front wheels can be unlocked again by turning the wheel lock (21) either way by 90°.

When mowing slopes, cut in lines across the slope.

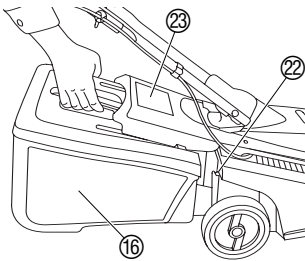
**Mowing with the grass box:**

The grass box must be emptied as soon as grass is left lying on the lawn.

**⚠ DANGER! Foreign bodies thrown out of the mower can cause injuries!**

→ Only lift protective flap with the motor switched off and the cutting blade stationary.

1. Lift protective flap (23) and take out grass box (16) by the handle.

2. Empty the grass box (16) and hang it on the back again using the mounting hook (22) on the casing.

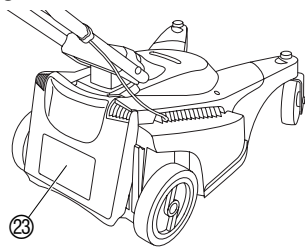
**Mowing without the grass box:**

**Do not put your hand in the discharge opening.**

When the protective flap (23) is released, this closes automatically and covers the discharge opening.

The protective flap (23) is arranged in such a way that it is still possible to mow with the protective flap closed but without a grass box. The cut grass is then dropped on the lawn.

**Mowing tips:**

If grass residue is left in the discharge opening, pull mower backwards about 1 m so that the grass residue can drop out downwards.

To produce a well-maintained lawn, we recommend cutting the lawn regularly once a week if possible. The lawn becomes thicker if cut frequently.

To establish a long interval between mowing (**e.g. whilst away on holiday**), first of all cut in one direction with the cutting height as high as possible, then cut in the crosswise direction at the cutting height required.

If possible, only cut the grass when it is dry, if the grass is damp, the cutting pattern will be uneven.

## 5. Storage

### Storing / transporting the mower:

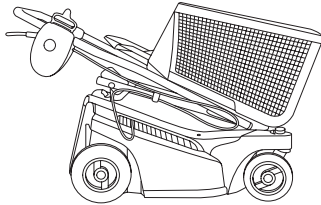

- Store the mower in a closed room to which children cannot gain access.
- 1. Switch off mower and disconnect extension cable.
- 2. To save space, release the wing nuts of the uprights until the joints can be folded together easily.
- 3. Store mower in a dry, enclosed and secure place.

**TIP:** To save space the grass box can be placed on top of the folded up mower.

**Disposal:**  
(in accordance with  
RL2002/96/EC)



The lawn mower must not be added to normal household waste. It must be disposed of in line with local environmental regulations.

## 6. Maintenance



**DANGER! Cutting blade can cause injuries!**

→ Before maintenance, wait until the cutting blade is stationary, wear suitable work gloves and pull out the mains plug.

**DANGER! Injury to persons and damage to property!**

→ Do not clean mower under running water (especially at high pressure).

Grass deposits make the starting process difficult, impair the quality of the cut and the discharge of the grass. Dirt and grass residues are easiest to remove immediately after mowing.

**Clean the underside of the mower casing:**

→ Lay mower on its side carefully and remove grass deposits (do not use sharp objects).

## 7. Troubleshooting



**DANGER! Cutting blade can cause injuries!**

→ Before rectifying faults, wait for the cutting blade to stop, wear suitable work gloves and pull out the mains plug.

## Replacing the blade:

**Blades with chipped edges must be replaced and must not be reground because this causes the mower to be out of balance.**



**The blade must only be replaced by GARDENA Service or a specialist dealer authorised by GARDENA.**

Only an original GARDENA blade must be used. GARDENA spares are available from your GARDENA dealer or via GARDENA Service.

### • GARDENA replacement blade Art. 4091

A damaged or bent blade must be replaced because it will be out of balance.

<b>Fault</b>	<b>Possible cause</b>	<b>Remedy</b>
<b>Motor will not start</b>	Power supply cable faulty.	→ Check power supply cable.
	Extension cable may not have a large enough cross-section.	→ Use extension cable with cross-section complying with table (2. <b>For your Safety</b> ).
<b>Motor jammed and making a noise</b>	Jammed with foreign body.	→ Switch off motor, pull out mains plug and remove foreign body.
	Cutting height too low for the lawn or mowing speed too high.	→ Raise cutting height or reduce mowing speed.
<b>Loud noises, mower rattling</b>	Screws on motor, its fixing or on the mower casing loose.	→ Have screws tightened by an authorised specialist dealer or GARDENA-Service.
<b>Runs unevenly, mower vibrates strongly</b>	Blade damaged or blade mounting released from motor shaft.	→ Have blade tightened or replaced by an authorised specialist dealer or GARDENA-Service.
	Out of balance because of very dirty blade.	→ Clean mower (see 6. Maintenance). If this does not rectify the fault, contact GARDENA Service.
<b>Lawn is not cleanly cut</b>	Blade blunt.	→ Have blade replaced.
	Cutting height too low.	→ Increase cutting height.
	Mowing speed too high.	→ Reduce mowing speed.

If any other faults occur, please contact GARDENA Service.

**Please contact GARDENA Service before sending the mower. Repairs may only be carried out by GARDENA service centres or dealers authorised by GARDENA.**



## 8. Technical Data

<b>34 E basicMove (Art. 4032)</b>	
<b>Power consumption</b>	1000 W
<b>Voltage / Frequency</b>	230 V / 50 Hz
<b>Cutting width / Cutting height</b>	34 cm / 2 – 6,5 cm (4 positions)
<b>Weight</b>	14.5 kg
<b>Volume of grass box</b>	30 l
<b>Working area related emission characteristic value <math>L_{pA}^{1)}</math></b>	76 dB (A)
<b>Noise level <math>L_{WA}^{2)}</math></b>	measured 87 dB (A) / guaranteed 87 dB (A)
<b>Vibrations <math>a_{vhw}^{1)}</math></b>	< 2,5 m/s <sup>2</sup>

Measuring method 1) according to EN 836 2) nach 84/538/EG

## 9. Warranty / Service

GARDENA guarantees this product for 2 years (starting from the date of purchase). This guarantee covers all serious defects of the unit that can be proved to be material or manufacturing faults. Under warranty we will either replace the unit or repair it free of charge if the following conditions apply:

- The unit must have been handled properly and in keeping with the requirements of the operating instructions.
- Neither the purchaser or a non-authorised third party have attempted to repair the unit.

The blade is a wearing part and is not covered by the guarantee.

This manufacturer's guarantee does not affect the user's existing warranty claims against the dealer/seller.

If a fault occurs with your Electric Lawnmower, please return the faulty unit together with a copy of the receipt and a description of the fault, with postage paid to one of the GARDENA Service Centres listed on the back of these operating instructions.

<p><b>D</b> <i>Produkthaftung</i></p>	<p>Wir weisen ausdrücklich darauf hin, dass wir nach dem Produkthaftungsgesetz nicht für durch unsere Geräte hervorgerufene Schäden einzustehen haben, sofern diese durch unsachgemäße Reparatur verursacht oder bei einem Teileaustausch nicht unsere Original GARDENA Teile oder von uns freigegebene Teile verwendet werden und die Reparatur nicht vom GARDENA Service oder dem autorisierten Fachmann durchgeführt wird. Entsprechendes gilt für Ergänzungsstücke und Zubehör.</p>
<p><b>GB</b> <i>Product Liability</i></p>	<p>We expressly point out that, in accordance with the product liability law, we are not liable for any damage caused by our products if it is due to improper repair or if parts exchanged are not original GARDENA parts or parts approved by us, and, if the repairs were not carried out by a GARDENA Service Centre or an authorised specialist. The same applies to spare parts and accessories.</p>
<p><b>F</b> <i>Responsabilité</i></p>	<p>Nous vous signalons expressément que GARDENA n'est pas responsable des dommages causés par ses appareils, dans la mesure où ces dommages seraient causés suite à une réparation non conforme, dans la mesure où, lors d'un échange de pièces, les pièces d'origine GARDENA n'auraient pas été utilisées, ou si la réparation n'a pas été effectuée par le Service Après-Vente GARDENA ou l'un des Centres SAV agréés GARDENA. Ceci est également valable pour tout ajout de pièces et d'accessoires autres que ceux préconisés par GARDENA.</p>
<p><b>NL</b> <i>Productaansprakelijkheid</i></p>	<p>Wij wijzen er nadrukkelijk op, dat wij op grond van de wet aansprakelijkheid voor producten niet aansprakelijk zijn voor schade ontstaan door onze apparaten, indien deze door onvakkundige reparatie veroorzaakt zijn, of er bij het uitwisselen van onderdelen geen gebruik gemaakt werd van onze originele GARDENA onderdelen of door ons vrijgegeven onderdelen en de reparatie niet door de GARDENA technische dienst of de bevoegde vakman uitgevoerd werd. Ditzelfde geldt voor extra-onderdelen en accessoires.</p>
<p><b>S</b> <i>Produktansvar</i></p>	<p>Tillverkaren är inte ansvarig för skada som orsakats av produkten om skadan beror på att produkten har reparerats felaktigt eller om, vid reparation eller utbyte, andra än Original GARDENA reservdelar har använts. Samma sak gäller för kompletteringsdelar och tillbehör.</p>
<p><b>I</b> <i>Responsabilità del prodotto</i></p>	<p>Si rende espressamente noto che, conformemente alla legislazione sulla responsabilità del prodotto, non si risponde di danni causati da nostri articoli se originati da riparazioni eseguite non correttamente o da sostituzioni di parti effettuate con materiale non originale GARDENA o comunque da noi non approvato e, in ogni caso, qualora l'intervento non venga eseguito da un centro assistenza GARDENA o da personale specializzato autorizzato. Lo stesso vale per le parti complementari e gli accessori.</p>
<p><b>E</b> <i>Responsabilidad de productos</i></p>	<p>Advertimos que conforme a la ley de responsabilidad de productos no nos responsabilizamos de daños causados por nuestros aparatos, siempre y cuando dichos daños hayan sido originados por arreglos o reparaciones indebidas, por recambios con piezas que no sean piezas originales GARDENA o bien piezas autorizadas por nosotros, así como en aquellos casos en que la reparación no haya sido efectuada por un Servicio Técnico GARDENA o por un técnico autorizado. Lo mismo es aplicable para las piezas complementarias y accesorios.</p>
<p><b>P</b> <i>Responsabilidade sobre o produto</i></p>	<p>Queremos salientar que segundo a lei da responsabilidade do fabricante, nós não nos responsabilizaremos por danos causados pelo nosso equipamento, quando estes ocorrerem em decorrência de reparações inadequadas ou da substituição de peças por peças não originais da GARDENA, ou peças não autorizadas. A responsabilidade tornar-se-á nula também depois de reparações realizadas por oficinas não autorizadas pela GARDENA. Esta restrição valerá também para peças adicionais e acessórios.</p>
<p><b>DK</b> <i>Produktansvar</i></p>	<p>Vi gør udtrykkeligt opmærksom på at i henhold til produktansvarsloven er vi ikke ansvarlige for skader forårsaget af vores udstyr, hvis det skyldes uautoriserede reparationer eller hvis dele er skiftet ud og der ikke er anvendt originale GARDENA dele eller dele godkendt af os, eller hvis reparationerne ikke er udført af GARDENA-service eller en autoriseret fagmand. Det samme gælder for ekstra udstyr og tilbehør.</p>

<p><b>D EU-Konformitätserklärung</b>  <b>Maschinenverordnung (9. GSGVO) / EMVG / Niedersp. RL</b>  Der Unterzeichnete GARDENA Manufacturing GmbH, Hans-Lorenser-Str. 40, D-89079 Ulm, bestätigt, dass die nachfolgend bezeichneten Geräte in der von uns in Verkehr gebrachten Ausführung die Anforderungen der harmonisierten EU-Richtlinien, EU-Sicherheitsstandards und produktspezifischen Standards erfüllen. Bei einer nicht mit uns abgestimmten Änderung der Geräte verliert diese Erklärung ihre Gültigkeit.</p>	Bezeichnung des Gerätes: Elektro-Rasenmäher Description of the unit: Electric Lawnmower Désignation du matériel : Tondeuse électrique Omschrijving van het apparaat: Elektrische grasmaaier Produktbeskrivning: Elektrisk Gräsklippare Descrizione del prodotto: Rasaerba elettrico Descripción de la mercancía: Cortacésped eléctrico Descrição do aparelho: Máquina de cortar relva eléctrica Beskrivelse af enhederne: Elektrisk plæneklipper
<p><b>GB EU Certificate of Conformity</b>  The undersigned GARDENA Manufacturing GmbH, Hans-Lorenser-Str. 40, D-89079 Ulm, hereby certifies that, when leaving our factory, the units indicated below are in accordance with the harmonised EU guidelines, EU standards of safety and product specific standards. This certificate becomes void if the units are modified without our approval.</p>	Typ: Art.-Nr.: Type: Art. No.: Type : Référence : Type: Art. nr.: Typ: 34 E basicMove Art. nr. : 4032 Modello: Art. : Tipo: Art. Nº: Tipo: Art. Nº: Type: Varenr. :
<p><b>F Certificat de conformité aux directives européennes</b>  Le constructeur, soussigné : GARDENA Manufacturing GmbH, Hans-Lorenser-Str. 40, D-89079 Ulm, déclare qu'à la sortie de ses usines le matériel neuf désigné ci-dessous était conforme aux prescriptions des directives européennes énoncées ci-après et conforme aux règles de sécurité et autres règles qui lui sont applicables dans le cadre de l'Union européenne. Toute modification portée sur ce produit sans l'accord express de GARDENA supprime la validité de ce certificat.</p>	EU-Richtlinien : Harmonisierte EN : EU directives: 98/37/EC EN ISO 12100-1 Directives européennes : 73/23/EC EN ISO 12100-2 EU-richtlijnen: 89/336/EC EN 836 EU direktiv: 89/336/EC EN 836 Direttive UE: 93/68/EC EN 60335-1 Normativa UE: 93/68/EC EN 60335-1 Directrices da UE: 2000/14/EC EN 60335-2-77 EU Retningslinier:
<p><b>NL EU-overeenstemmingsverklaring</b>  Ondergetekende GARDENA Manufacturing, Hans-Lorenser-Str. 40, D-89079 Ulm, bevestigt, dat de volgende genoemde apparaten in de door ons in de handel gebrachte uitvoering voldoen aan de eis van, en in overeenstemming zijn met de EU-richtlijnen, de EU-veiligheidsstandaard en de voor het product specifieke standaard. Bij een niet met ons afgestemde verandering aan de apparaten verliest deze verklaring haar geldigheid.</p>	Hinterlegte Dokumentation: Konformitätsbewertungsverfahren: GARDENA – Nach 2000/14EG Technische Dokumentation Art. 14 Anhang VI
<p><b>S EU Tillverkarintyg</b>  Undertecknad firma GARDENA Manufacturing GmbH, Hans-Lorenser-Str. 40, D-89079 Ulm, intygar härmed att nedan nämnda produkter överensstämmer med EU:s direktiv, EU:s säkerhetsstandard och produktspecifikation. Detta intyg upphör att gälla om produkten ändras utan vårt tillstånd.</p>	Schall-Leistungspegel: gemessen / garantiert Noise level: mesuré / garantie Puissance acoustique : mesurée / garantie Geluidsniveau: gemeten / gegarandeerd Ljudnivå: uppmätt / garanterad Livello rumorosità: testato / garantito Nível sonoro: medido / garantizado Nível de ruído: medido / garantido Lydtrykkniveau: atmålt / garanti 34 E basicMove: 87 dB (A) / 87 dB (A)
<p><b>I Dichiarazione di conformità alle norme UE</b>  La sottoscritta GARDENA Manufacturing GmbH, Hans-Lorenser-Str. 40, D-89079 Ulm, certifica che il prodotto qui di seguito indicato, nei modelli da noi commercializzati, è conforme alle direttive armonizzate UE nonché agli standard di sicurezza e agli standard specifici di prodotto. Qualunque modifica apportata al prodotto senza nostra specifica autorizzazione invalida la presente dichiarazione.</p>	Anbringningsjahr der CE-Kennzeichnung: Year of CE marking: Date d'apposition du marquage CE : Installatiejaar van de CE-aanduiding: 2005 CE-Märkningsår: Anno di rilascio della certificazione CE: Colocación del distintivo CE: Ano de marcação pela CE: CE-Mærkningsår:
<p><b>E Declaración de conformidad de la UE</b>  El que suscribe GARDENA Manufacturing, Hans-Lorenser-Str. 40, D-89079 Ulm, declara que la presente mercancía, objeto de la presente declaración, cumple con todas las normas de la UE, en lo que a normas técnicas, de homologación y de seguridad se refiere. En caso de realizar cualquier modificación en la presente mercancía sin nuestra previa autorización, esta declaración pierde su validez.</p>	
<p><b>P Certificado de conformidade da UE</b>  Os abaixo mencionados GARDENA Manufacturing GmbH, Hans-Lorenser-Str. 40, D-89079 Ulm, por este meio certificam que ao sair da fábrica o aparelho abaixo mencionado está de acordo com as diretrizes harmonizadas da UE, padrões de segurança e de produtos específicos. Este certificado ficará nulo se a unidade for modificada sem a nossa aprovação.</p>	 Peter Lameli Ulm, den 01.12.2005 Technische Leitung Ulm, 01.12.2005 Technical Dept. Manager Fait à Ulm, le 01.12.2005 Direction technique Ulm, 01-12-2005 Hoofd technische dienst Ulm, 2005.12.01. Technical Director Ulm, 01.12.2005 Direzione Tecnica Ulm, 01.12.2005 Dirección Técnica Ulm, 01.12.2005 Director Técnico Ulm, 01.12.2005 Teknisk direktør
<p><b>DK EU Overensstemmelse certificat</b>  Undertegnede GARDENA Manufacturing GmbH, Hans-Lorenser-Str. 40, D-89079 Ulm bekræfter hermed, at enheder listet herunder, ved afsendelse fra fabrikken, er i overensstemmelse med harmoniserede EU retningslinier, EU sikkerhedsstandarder og produktspecifikationsstandarder. Dette certifikat træder ud af kraft hvis enhederne er ændret uden vor godkendelse.</p>	

**Deutschland / Germany**

GARDENA  
Manufacturing GmbH  
Service Center  
Hans-Lorenser-Straße 40  
D-89079 Ulm  
Produktfragen:  
(+49) 731 490-123  
Reparaturen:  
(+49) 731 490-290  
service@gardena.com

**Argentina**

Argensem® S.A.  
Calle Colonia Japonesa s/n  
(1625) Loma Verde  
Escobar, Buenos Aires  
Phone: (+54) 34 88 49 40 40  
info@argensem.com.ar

**Australia**

Nylex Consumer Products  
50-70 Stanley Drive  
Somerton, Victoria, 3062  
Phone: (+61) 1800 658 276  
spare.parts@nylex.com.au

**Austria / Österreich**

GARDENA  
Österreich Ges.m.b.H.  
Stettnerweg 11-15  
2100 Korneuburg  
Tel.: (+43) 22 62 7 45 45 36  
kundendienst@gardena.at

**Belgium**

GARDENA Belgium NV/SA  
Sterrebeekstraat 163  
1930 Zaventem  
Phone: (+32) 2 720 92 12  
Mail: info@gardena.be

**Brazil**

Palash Comércio e  
Importação Ltda.  
Rua Américo Brasiliense,  
2414 - Chácara Sto Antonio  
São Paulo - SP - Brasil -  
CEP 04715-005  
Phone: (+55) 11 5181-0909  
eduardo@palash.com.br

**Bulgaria**

DENEX LTD.  
2 Luis Ahalier Str. - 7th floor  
Sofia 1404  
Phone: (+359) 2 958 18 21  
office@denex-bg.com

**Canada**

GARDENA Canada Ltd.  
100 Summerlea Road  
Brampton, Ontario L6T 4X3  
Phone: (+1) 905 792 9330  
info@gardenacanada.com

**Chile**

Antonio Martinic y Cia Ltda.  
Cassillas 272  
Centro de Cassillas  
Santiago de Chile  
Phone: (+56) 2 20 10 708  
garfar\_cl@yahoo.com

**Costa Rica**

Compania Exim  
Euroberoamericana S.A.  
Los Colegios, Moravia,  
200 metros al Sur del Colegio  
Saint Francis - San José  
Phone: (+506) 297 68 83  
exim\_euro@racsa.co.cr

**Croatia**

KLIS d.o.o.  
Stancecva 79  
10419 Vukovina  
Phone: (+385) 1 622 777 0  
gardena@klis-trgovina.hr

**Cyprus**

FARMOKIPIKI LTD  
P.O. Box 7098  
74, Digeni Akritra Ave.  
1641 Nicosia  
Phone: (+357) 22 75 47 62  
condam@spidernet.com.cy

**Czech Republic**

GARDENA spol. s r.o.  
Řípská 20a, č.p. 1153  
627 00 Brno  
Phone: (+420) 800 100 425  
gardena@gardenabrno.cz

**Denmark**

GARDENA Norden AB  
Salgsafdeling Danmark  
Box 9003  
S-200 39 Malmö  
info@gardena.dk

**Finland**

Habitex Oy  
Martinkyläntie 52  
01720 Vantaa

**France**

GARDENA  
PARIS NORD 2  
69, rue de la Belle Etoile  
BP 57080  
ROISSY EN FRANCE  
95948 ROISSY CDG CEDEX  
Tél. (+33) 0826 101 455  
service.consommateurs@  
gardena.fr

**Great Britain**

GARDENA UK Ltd.  
27-28 Brenkley Way  
Bleazard Business Park  
Seaton Burn  
Newcastle upon Tyne  
NE13 6DS  
info@gardena.co.uk

**Greece**

Agrokrip  
G. Psomadopoulos & Co.  
33 A, Ifestou Str. –  
Industrial Area  
194 00 Koropi, Athens  
Phone: (+30) 210 66 20 225  
service@agrokrip.gr  
www.agrokrip.gr

**Hungary**

GARDENA  
Magyarország Kft.  
Késmárk utca 22  
1158 Budapest  
Phone: (+36) 80 20 40 33  
gardena@gardena.hu

**Iceland**

Ó. Johnson & Kaaber  
Tunguhalsi 1  
110 Reykjavik  
oaj@ojk.is

**Ireland**

Michael McLoughlin & Sons  
Hardware Limited  
Long Mile Road  
Dublin 12

**Italy**

GARDENA Italia S.p.A.  
Via Donizetti 22  
20020 Lainate (Mi)  
Phone: (+39) 02.93.94.79.1  
info@gardenaitalia.it

**Japan**

KAKUICHI Co. Ltd.  
Sumitomo Realty &  
Development Kojimachi  
BLDG., 8F  
5-1 Nibanncho, Chiyoda-ku  
Tokyo 102-0084  
m\_ishihara@kaku-ichi.co.jp  
Phone: (+81) 33 264 4721

**Luxembourg**

Magasins Jules Neuberg  
Boîte postale 12  
L-2010 Luxembourg  
Phone: (+352) 40 14 01  
info@neuberg.lu

**Netherlands**

GARDENA Nederland B.V.  
Postbus 50176  
1305 AD ALMERE  
Phone: (+31) 36 521 00 00  
info@gardena.nl

**Neth. Antilles**

Jonka Enterprises N.V.  
Sta. Rosa Weg 196  
P.O. Box 8200  
Curaçao  
Phone: (+599) 9 767 66 55  
pgm@jonka.com

**New Zealand**

NYLEX New Zealand Limited  
Building 2  
118 Savill Drive  
Mangere, Auckland  
Phone: (+64) 9 270 1806  
lena.chapman@nylex.com.au

**Norway**

GARDENA Norden AB  
Salgskontor Norge  
Karihaugveien 89  
1086 Oslo  
info@gardena.no

**Poland**

GARDENA Polska Sp. z o.o.  
Szymanów 9 d  
05-532 Baniocza  
Phone: (+48) 22 727 56 90  
gardena@gardena.pl

**Portugal**

GARDENA Portugal Lda.  
Recta da Granja do Marquês  
Edif. GARDENA Algueirão  
2725-596 Mem Martins  
Phone: (+351) 21 922 85 30  
info@gardena.pt

**Romania**

MADEX INTERNATIONAL SRL  
Soseaua Odaii 117-123,  
Sector 1,  
București, RO 013603  
Phone: (+40) 21 352 76 03  
madox@ines.ro

**Russia / Россия**

АО АМИДА ТТЦ  
ул. Мосфильмовская 66  
117330 Москва  
Phone: (+7) 095 956 99 00  
amida@col.ru

**Singapore**

Hy - Ray PRIVATE LIMITED  
40 Jalan Pemimpin  
#02-08 Tat Ann Building  
Singapore 577185  
Phone: (+65) 6253 2277  
hyray@singnet.com.sg

**Slovak Republic**

GARDENA Slovensko, s.r.o.  
Bohrova č. 1  
85101 Bratislava  
Phone: (+421) 263 453 722  
info@gardena.sk

**Slovenia**

Silk d.o.o.  
Brodšče 15  
1236 Trzin  
Phone: (+386) 1 580 93 00  
gardena@silks.si

**South Africa**

GARDENA  
South Africa (Pty.) Ltd.  
P.O. Box 11534  
Vorna Valley 1686  
Phone: (+27) 11 315 02 23  
sales@gardena.co.za

**Spain**

GARDENA IBÉRICA S.L.U.  
C/ Basauri, nº 6  
La Florida  
28023 Madrid  
Phone: (+34) 91 708 05 00  
(4 líneas)  
atencioncliente@gardena.es

**Sweden**

GARDENA Norden AB  
Försäljningskontor Sverige  
Box 9003  
200 39 Malmö  
info@gardena.se

**Switzerland / Schweiz**

GARDENA (Schweiz) AG  
Bitzberg 1  
8184 Bachenbülach  
Phone: (+41) 1 860 26 66  
info@gardena.ch

**Turkey**

GARDENA / Dost Diş Ticaret  
Mümesillik A.Ş. Sanayi  
Çad. Adil Sokak No. 1  
Kartal - Istanbul  
Phone: (+90) 216 38 93 939  
info@gardena-dost.com.tr

**Ukraine / Украина**

АОЗТ АЛЬЦЕСТ  
ул. Іайдара 50  
г. Киев 01033  
Phone: (+380) 44 220 4335  
info@gardena.ua

**USA**

Melnor Inc.  
3085 Shawnee Drive  
Winchester, VA 22604  
Phone: (+1) 540 722-9080  
service\_us@melnor.com

4032-20.960.01/1205

© GARDENA  
Manufacturing GmbH  
D-89070 Ulm  
http://www.gardena.com