RADEON™ 8500

RADEON™ 8500LE

RADEON™ 7500

User's Guide

Version 5.0

P/N 137-40282-50 Rev. D

Copyright © 2002, ATI Technologies Inc. All rights reserved.

ATI and all ATI product and product feature names are trademarks and/or registered trademarks of ATI Technologies Inc. All other company and/or product names are trademarks and/or registered trademarks of their respective owners. Features, performance and specifications are subject to change without notice. Product may not be exactly as shown in the diagrams.

Reproduction of this manual, or parts thereof, in any form, without the express written permission of ATI Technologies Inc. is strictly prohibited.

Disclaimer

While every precaution has been taken in the preparation of this document, ATI Technologies Inc. assumes no liability with respect to the operation or use of ATI hardware, software or other products and documentation described herein, for any act or omission of ATI concerning such products or this documentation, for any interruption of service, loss or interruption of business, loss of anticipatory profits, or for punitive, incidental or consequential damages in connection with the furnishing, performance, or use of the ATI hardware, software, or other products and documentation provided herein.

ATI Technologies Inc. reserves the right to make changes without further notice to a product or system described herein to improve reliability, function or design. With respect to ATI products which this document relates, ATI disclaims all express or implied warranties regarding such products, including but not limited to, the implied warranties of merchantability, fitness for a particular purpose, and non-infringement.

Product Notice

MACROVISION

A.Apparatus Claims of U.S. Patent Nos. 4,631,603, 4,577,216, 4,819,098, and 4,907,093 licensed for limited viewing users only.

B.In the printed collateral material that accompanies the Product, the following notice must be printed in an appropriate place in such materials:

This product incorporates copyright protection technology that is protected by method claims of certain U.S. patents and other intellectual property rights owned by Macrovision Corporation and other rights owners. Use of this copyright protection technology must be authorized by Macrovision Corporation, and is intended for home and other limited viewing uses unless otherwise authorized by Macrovision Corporation. Reverse engineering or disassembly is prohibited.

Table of Contents

- Introduction. 1**
- Features At A Glance 2**
 - RADEON 7500 2
 - RADEON 8500 and RADEON 8500LE 2
- ATI's CATALYST™ Software Suite 3**
 - Multiple Displays and 3D Gaming Experience..... 3
 - Direct 3D® and OpenGL® 3
 - HydraVision™ 3
- Multiple Displays 4**
- Connecting Your Monitor(s) 4**
- CATALYST Software Suite 5**
- ATI Displays Tab..... 5**
 - Enabling/Disabling Secondary Displays 6
 - Enabling Extended Desktop Mode..... 6
 - Dynamic Display Reassignment 6
 - Virtually Repositioning Your Displays 8
 - Ratiometric Expansion 8
- ATI Color Tab 9**
- ATI Options Tab..... 11**
- ATI Overlay Tab 12**
- Direct 3D® Control Panel. 14**
- Main and Custom Settings..... 14**
- Direct 3D® Compatibility Settings 17**
- OpenGL® Control Panel 19**
- Main and Custom Settings..... 19**
- OpenGL® Compatibility Settings..... 22**
- Using TV Out. 23**
 - View your PC's display on a TV..... 23
- Connecting to a TV or a VCR 23**
 - Starting Windows® with TV Display Enabled 25
 - Using SCART Connectors for European TVs 25
 - How To Enable/Disable The TV Display 25
 - Using and Adjusting TV Out..... 26
 - How TV Display Cannot Be Used 26
 - Using a Monitor vs. Using the TV Display..... 26
 - Adjusting Monitor Display..... 27

Viewing Text on a TV	27
Reducing Edge Distortion	28
Changing Display Configurations	29
Using Games and Applications	29

Introduction

The RADEON family of graphic accelerators delivers ground breaking 3D graphics performance.

- Designed and built by ATI Technologies Inc.
- Powered by the RADEON Visual Processing Unit (VPU).
- Awesome 3D gaming performance.
- Support for OpenGL[®] applications.
- Support for Direct 3D[®] applications.
- High resolution in 3D up to 2048x1536.
- Best performance for today's and tomorrow's applications.
- Supports TV-out to connect your PC to your TV or VCR.

Features At A Glance

RADEON 7500

The RADEON 7500 provides high performance acceleration for today's demanding 3D graphic applications. Its main features are:

- VIDEO IMMERSION™ which provides industry-leading DVD playback and digital TV decode capability
- CHARISMA ENGINE™ which is the main VPU, providing the necessary power to accelerate today's 3D games and applications
- PIXEL TAPESTRY™ which can apply 3 textures at once to a complex 3D gaming scene
- TV output support

RADEON 8500 and RADEON 8500LE

In addition to the features of the RADEON 7500, the RADEON 8500 series also provides:

- TRUFORM™ technology which makes the curved surfaces of 3D objects look smoother and more life-like
- SMARTSHADER™ technology which can realistically create the visual properties of any material, like glass, metal, wood, and produce 3D depth by rendering the object's shadows
- SMOOTHVISION™ which provides users with various degrees of jagged edge removal from 3D images, allowing users to configure their own high quality or high performance gaming experience
- PIXEL TAPESTRY™ II which provides even greater 3D rendering power
- Digital flat panel support (RADEON 8500 only)

ATI's CATALYST™ Software Suite

Multiple Displays and 3D Gaming Experience

ATI's CATALYST Software Suite provides multiple display functionality, and the advanced graphic features, such as TRUFORM, for the ultimate 3D gaming experience. For help on installing the CATALYST Software Suite, refer to the **Getting Started Guide**.

The CATALYST Software Suite installs the ATI display tabs. These tabs are accessed through the Windows® **Display** Control Panel, through the **Advanced...** button located on the **Settings** tab. For a detailed explanation of each ATI tab, refer to [CATALYST Software Suite on page 5](#).

Direct 3D® and OpenGL®

The CATALYST Software Suite supports the latest versions of Direct 3D® and OpenGL®. Your 3D game titles will come to life, as you can tweak the game's settings for maximum 3D image quality or 3D gaming performance.

ATI's Direct 3D® and OpenGL® tabs are available through the Windows® **Display** Control Panel, through the **Advanced...** button located on the **Settings** tab.

For a detailed explanation of the Direct 3D® and OpenGL® tabs, refer to [Direct 3D® Control Panel on page 14](#), and [OpenGL® Control Panel on page 19](#).

HydraVision™

You can also use HydraVision for advanced multi-monitor management. For more information please refer to the **HydraVision User's Guide** PDF located on your ATI Installation CD.

Multiple Displays

Connecting Your Monitor(s)

The RADEON 8500 provides hardware support for one DVI-I monitor or two VGA monitors using the DVI-I-to-VGA adapter. A TV can also be used to expand your desktop by using the S-Video out. The RADEON 7500 provides support for one VGA monitor and Composite output to a TV.

Plug the monitor cable into your card (if you are running multiple monitors, connect their cables to the appropriate connectors), **then turn on the PC and monitor(s).**

To connect a flat panel **directly** to your RADEON 8500, use the DVI-I connector. To connect a VGA monitor to the DVI-I connector, use the DVI-I-to-VGA adapter as shown below.

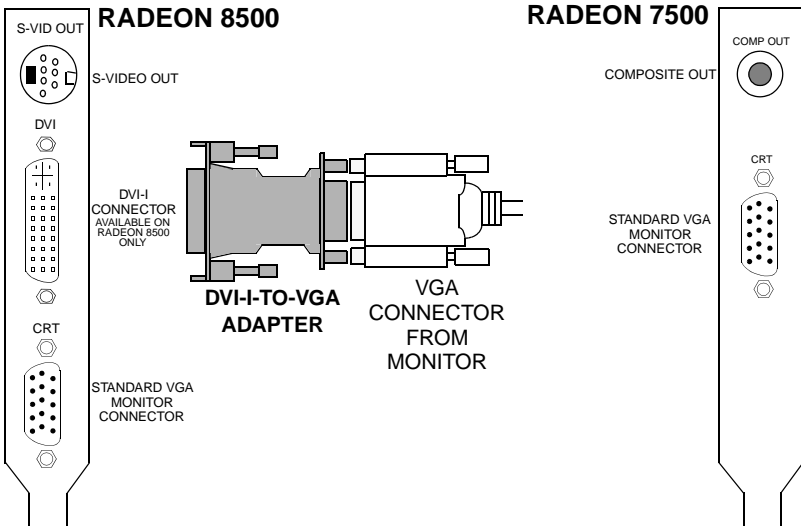

When you use multiple monitors with your card, one monitor will always be **Primary**. Any additional monitor(s) will be designated as **Secondary**.

CATALYST Software Suite

The following section provides an explanation of each ATI tab available after installing the CATALYST Software Suite.



Features presented in the following pages may not be supported in all operating systems and/or may appear differently.

ATI Displays Tab

The ATI Displays tab provides the multi monitor features. Here you can enable/disable display devices and swap the assignment of **Primary** and **Secondary** displays.

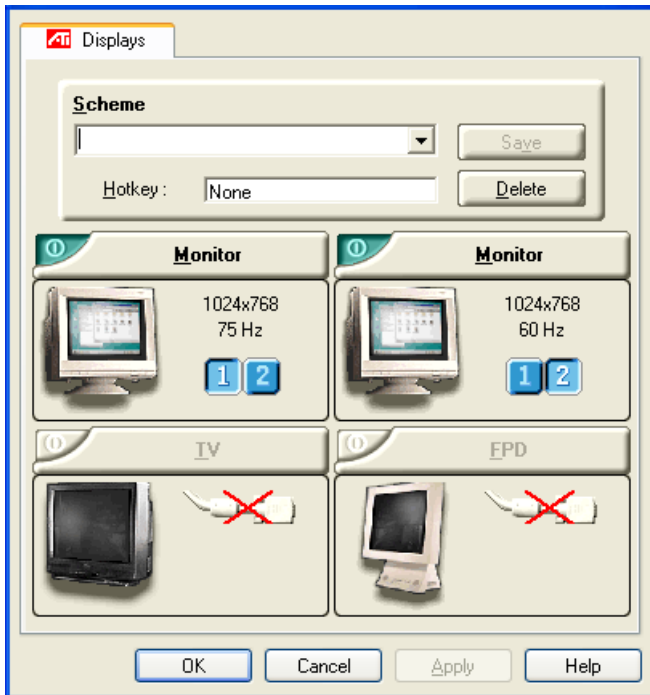

Enabling/Disabling Secondary Displays

- 1 Access the Windows[®] **Control Panel**. Double-click **Display**.
- 2 Click on the **Settings** tab and then the **Advanced...** button.
- 3 Click on the **ATI Displays** tab.
- 4 Click the enable/disable button  for the display device you want to enable/disable.
- 5 Click **OK** or **Apply** to save the changes.

Enabling Extended Desktop Mode

- 1 Access the Windows[®] **Control Panel**. Double-click **Display**.
- 2 Click on the **Settings** tab.
- 3 Click the monitor icon for the display onto which you want to extend your desktop.
- 4 Click **Yes** to enable the selected display.
- 5 Checkmark the **Extend my Windows desktop onto this monitor** check box (Windows[®] may automatically place it there).
- 6 Click **OK** or **Apply** to save the changes.



Dynamic Display Reassignment





You can change the assignment of your **Primary** and **Secondary** display on the fly, without rebooting. However, before you can change the assignment of the **Primary** display, at least one **Secondary** display must be enabled, and Extended Desktop mode must be enabled.

To enable a Secondary display, refer to the section [Enabling/Disabling Secondary Displays](#).

To enable Extended Desktop Mode, refer to the section [Enabling Extended Desktop Mode](#).

- 1 Access the Windows[®] **Control Panel**. Double-click **Display**.
- 2 Click on the **Settings** tab and then the **Advanced...** button.
- 3 Click on the **ATI Displays** tab.

The ATI Displays tab shows you the display(s) that are active. The Primary display has the  button depressed. To change the display assignment, you can click the Primary display's  button or you can click the  button of the other display device.

In Windows[®] 2000 and Windows[®] NT4.0, clicking on the  button will reassign the Primary and Secondary monitors. Clicking on the  button creates a clone or mirror image of the Primary display onto the Secondary display. Clicking on the  button extends your desktop to a Secondary display located to the right of the Primary display. Clicking on the  button extends your desktop to a Secondary display located below the Primary display.

- 4 Click **OK** or **Apply** to save the changes.

Virtually Repositioning Your Displays

- 1 On the **Settings** tab, click and drag the appropriate monitor icon to the desired position. For example, the secondary display can be dragged to the left of the primary display, allowing it to be virtually on the left, as shown below.
- 2 Click **OK** or **Apply** to save the changes.

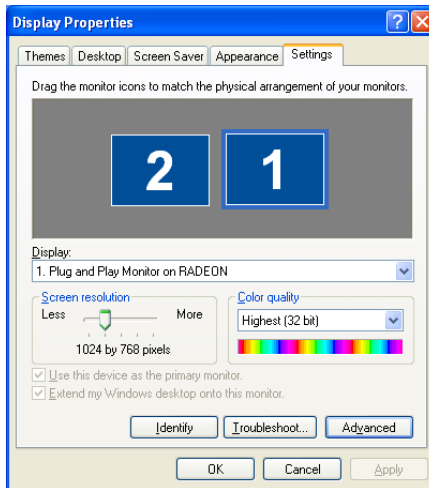

Ratiometric Expansion

Your RADEON card offers ratiometric expansion (or digital panel scaling as it is commonly known). This expands a low resolution image to fill a higher resolution panel. However, ratiometric expansion is only available on the **Primary** display. Therefore, if a flat panel display (FPD) is set as Secondary, the Extended Desktop mode is disabled and the resolution is less than the FPD's native resolution. This causes the FPD to default to center mode.

ATI Color Tab

The ATI Color tab is used to adjust the color settings. You can change the red, green and blue display colors. Desktop brightness and Game Gamma (brightness) can also be changed.

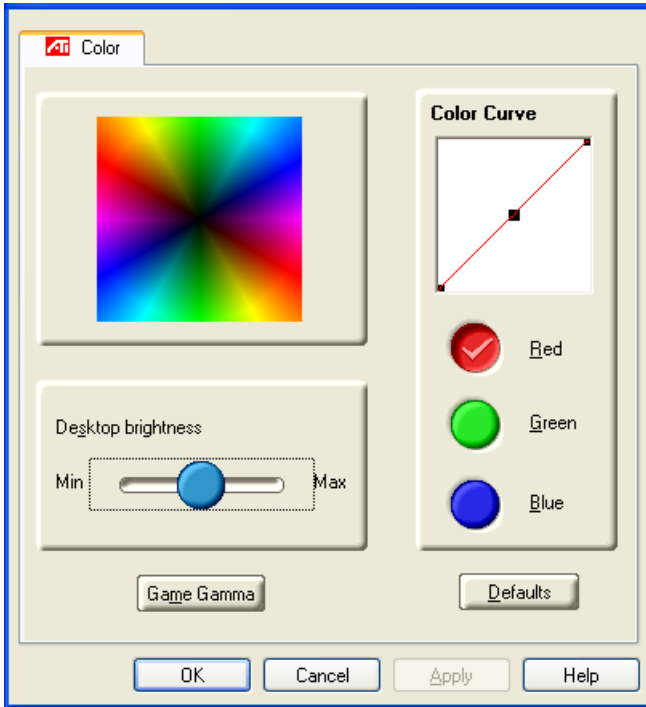

ATI Color Tab	
Desktop Brightness	This increases or decreases the brightness of your desktop. The higher the gamma value, the higher the brightness of your display.
Color Curve	This adjusts the selected color (red, green or blue check button) by moving the color curve with your mouse.
Game Gamma button	This accesses Game Gamma Properties.
Defaults button	This allows you to reset the desktop brightness and color settings to default values.

Clicking the **Game Gamma** button accesses the Game Gamma Properties.

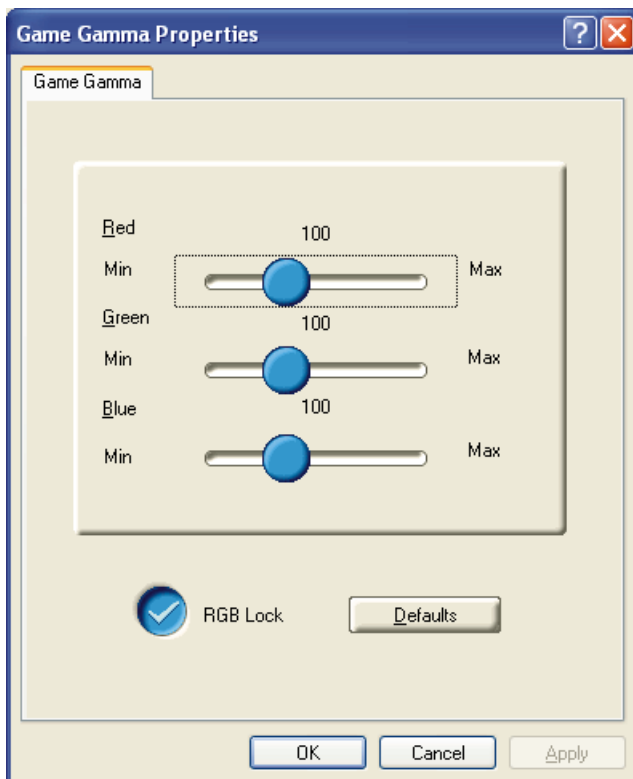

Game Gamma Properties

Red Green Blue sliders	These controls allow you to increase or decrease the color brightness of Direct 3D and OpenGL games played in fullscreen mode. (NOTE: Game Gamma is NOT supported in Windows NT4.0)
RGB Lock	Uncheck this to adjust the RGB sliders individually. Check this to adjust all three sliders at the same time.
Defaults button	This allows you to reset the Game Gamma settings to default values.

ATI Options Tab

The ATI Options tab provides detailed driver information and access to the card's specifications. You can also enable or disable the ATI taskbar icon.

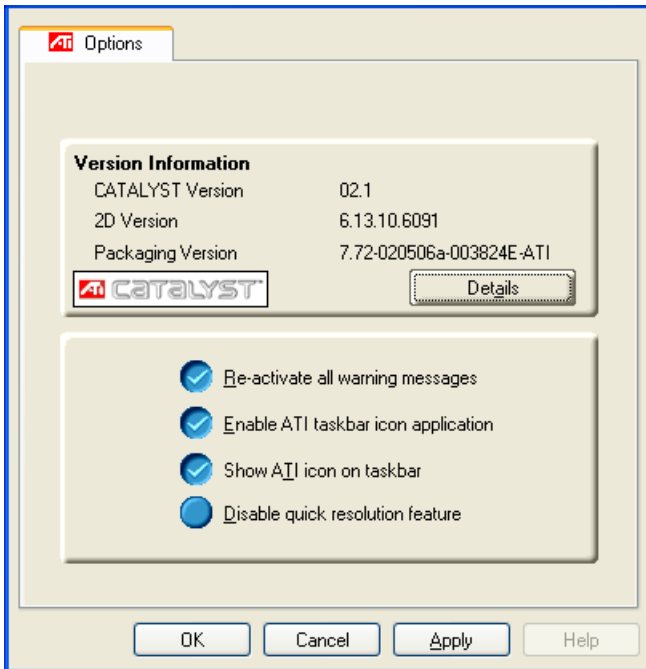

ATI Options Tab	
Version Information	Provides the CATALYST version number, 2D version number and the driver build information.
Details button	Provides access to the Details tab which lists the card's hardware details and driver information.
Reactivate all warning messages	This allows you to reactivate any disabled graphics warning messages.
Enable ATI taskbar icon application	Unchecking this allows you to disable the ATI taskbar applications and removes the ATI icon from your system tray.

Show ATI icon on taskbar	Unchecking this allows you to remove the ATI icon from your system tray without disabling the ATI icon applications.
Disable quick resolution feature	Quick resolution feature is accessible by left-clicking the ATI icon in the system tray. Checking this option disables the feature.

ATI Overlay Tab

The ATI Overlay tab allows you to configure the brightness, contrast, saturation, hue and gamma properties of your video overlay.

Video Overlay

Video overlay allows for the viewing of full-motion video on your PC. However, there is only one video overlay, which is only available on the **Primary** display. The video overlay controls are automatically activated during playback of any video file type that supports overlay adjustments.

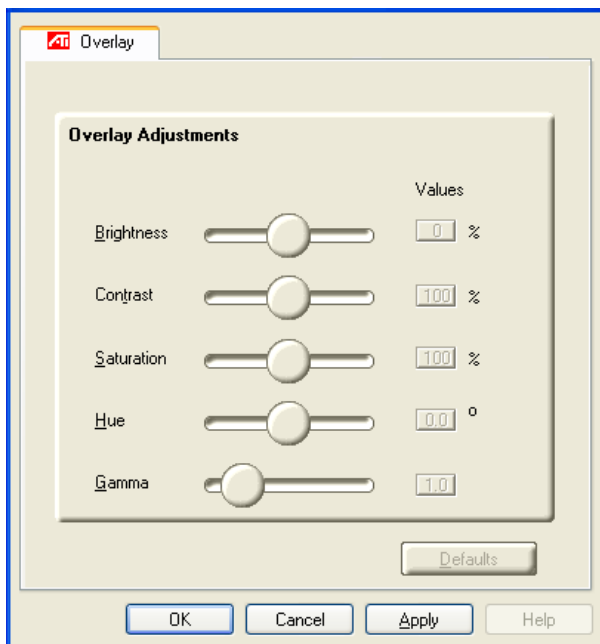

ATI Overlay Tab	
Brightness	Use this slider to adjust the brightness of the video image.
Contrast	Use this slider to adjust the contrast in the video image.
Saturation	Use this slider to adjust the vividness of the color. Sliding it all the way to the left removes all color and produces a black and white picture.
Hue	Use this slider to adjust the pureness or tint of the red, green and blue components of the color.
Gamma	Use this slider to adjust the overall intensity of the video image.
Defaults button	This allows you to reset the Overlay settings to default values.

Direct 3D[®] Control Panel

Using this tab, gamers can tweak the settings of their Direct 3D[®] games.

Main and Custom Settings

In the **Main Settings** you can maximize overall performance by moving the slider to the left, or you can enhance overall image quality by moving the slider to the right.

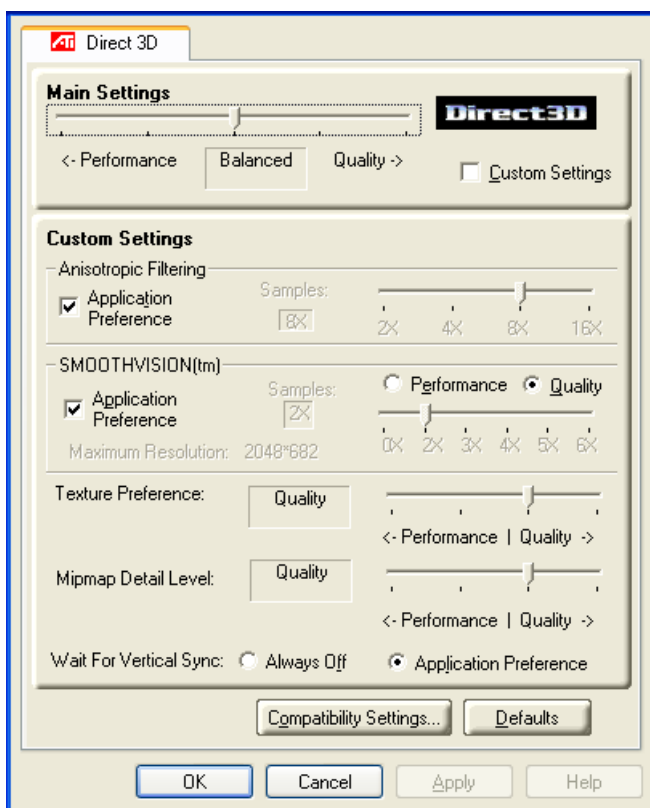

Main Settings slider	This allows you to emphasize what kind of application experience you'd like to have. Moving the slider to the left will maximize application performance, while moving the slider to the right will provide excellent 3D image quality. Moving this slider from one position to the next changes the individual Custom Settings sliders found below.
Custom Settings checkbox	When Custom Settings is checked, the Main Settings slider is disabled, allowing you to move each individual slider in the Custom Settings section below. Setting the individual sliders gives you complete control over your application experience. Using Custom Settings is recommended for advanced users only.
Anisotropic Filtering checkbox	Anisotropic filtering uses a texture filtering technique that blends multiple texture samples together. Selecting Application Preference will result in high quality textures, with a negligible reduction in the application's performance.
Anisotropic Filtering slider	The number of samples taken when anisotropic filtering is performed can vary. By moving this slider to the right, as the number of samples taken increases, the quality of the final image increases significantly. 16X provides extremely detailed, crisp-looking images as a result of the largest number of texture samples possible.
SMOOTH VISION checkbox	SmoothVision (Anti-Aliasing) improves image quality by removing jagged edges from 3D images, resulting in smoother, more natural-looking objects. Selecting Application Preference will result in high quality images, with a negligible reduction in the application's performance.
SMOOTH VISION Performance button	Select Performance for the best possible 3D gaming performance at a slight reduction in 3D image quality. The maximum screen resolution possible will automatically be indicated.
SMOOTH VISION Quality button	Select Quality for the best possible 3D image quality at a slight reduction in 3D gaming performance. The maximum screen resolution possible will automatically be indicated.
SMOOTH VISION slider	SmoothVision (Anti-Aliasing) can be applied using different sample patterns and sample points such as 2X or 4X. Moving this slider to the right increases sampling to provide the most realistic 3D image.

Texture Preference slider	Selecting this decides whether your application should use high quality or high performance textures. Moving the slider to the right delivers the highest quality experience. Moving the slider to the left emphasizes a high performance solution while still providing good visuals.
Mipmap Detail Level slider	This will allow you to choose the texture quality of the mipmaps the application will use. Mipmaps are a collection of different sized textures of the same image. As the user moves closer to a 3D object the image quality should increase, requiring a higher quality texture of the same image. The base mipmap is the highest quality texture, and all subsequent mipmaps are smaller sized textures of the same image. Moving the slider to the right selects a higher quality base mipmap, delivering the highest quality application experience. Moving the slider to the left selects a lower quality mipmap, delivering the highest application performance.
Wait for Vertical Sync	Wait for vertical sync will lower the frame rate of full screen games but reduce the image tearing that can occur with the higher frame rate. Selecting Application Preference allows the application to decide whether or not it should display its frames at the refresh rate of the monitor. Selecting Always Off allows the application to run at its highest possible frame rate, regardless of the monitor's refresh rate which is typically less than the frame rate at which the application will run.
Compatibility Settings button	This button allows you to access advanced settings that can solve compatibility issues for a few specific Direct 3D applications.
Defaults	This button allows you to reset the Direct3D settings to default values.

Direct 3D[®] Compatibility Settings

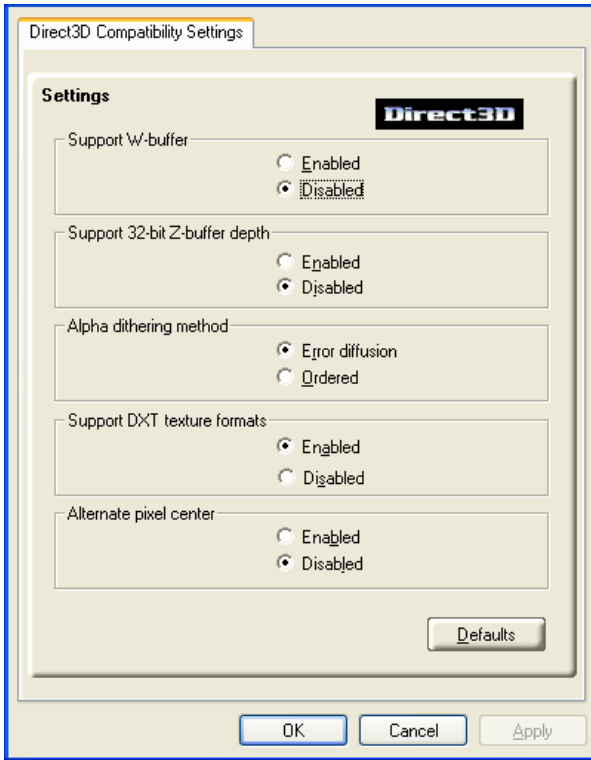

Support W-buffer

This will enable W-Buffer support for 3D games. It is recommended to disable this for games that do not support this feature. Certain applications require the increased precision of W-Buffering and will exhibit artifacts unless the W-Buffer is enabled.

Support 32-bit Z-buffer depth

Z-Buffer Bit Depth can be 16 bits, 24 bits, or 32 bits. 16 and 24 are selected by default to achieve optimum performance. Very few applications require a 32 bit Z-Buffer, so in most cases this feature should be disabled.

Alpha dithering method	When applications use both dithering and alpha blending, visual artifacts can occur. This option allows you to select how the application should handle both features at the same time. In most cases Error Diffusion will handle this situation quite well, but there are a few cases where selecting Ordered may be necessary.
Support DXT texture formats	Enabling this allows applications to use this kind of texture format. There are a few applications that can only support a limited number of texture formats. By selecting Disabled , the driver will not support DXT texture formats, thus reducing the number of texture formats supported.
Alternate pixel center	This may eliminate problems with some D3D games which display vertical and horizontal lines around textures, or text that appears incorrect. However, this setting should only be used if you are experiencing the symptoms mentioned, as it may cause problems with other games.
Defaults button	This button allows you to reset the Direct 3D Compatibility Settings to default values.

OpenGL[®] Control Panel

Using this tab, gamers can tweak the settings of their OpenGL[®] games.

Main and Custom Settings

In the **Main Settings** you can maximize overall performance by moving the slider to the left, or you can enhance overall image quality by moving the slider to the right.

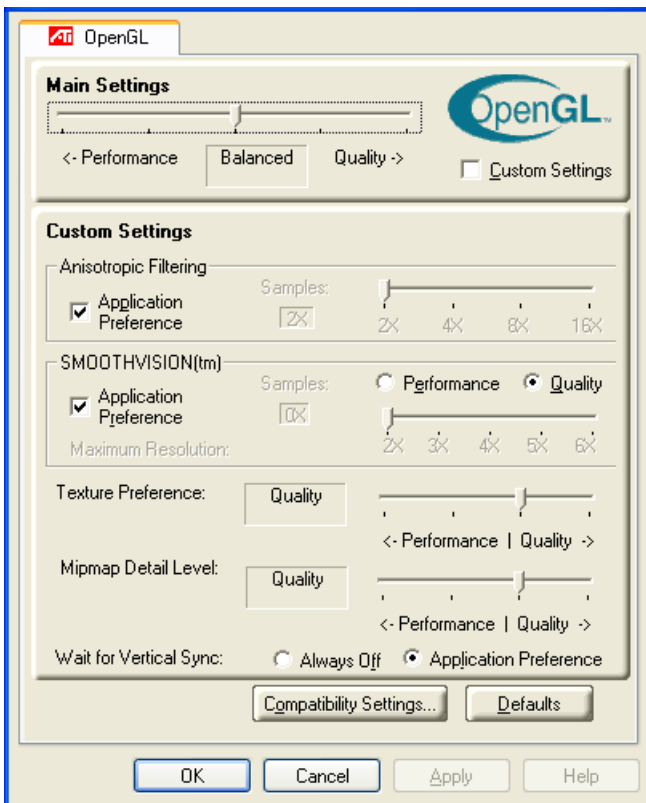

Main Settings slider	This allows you to emphasize what kind of application experience you'd like to have. Moving the slider to the left will maximize application performance, while moving the slider to the right will provide excellent 3D image quality. Moving this slider from one position to the next changes the individual Custom Settings sliders found below.
Custom Settings checkbox	When Custom Settings is checked, the Main Settings slider is disabled, allowing you to move each individual slider in the Custom Settings section below. Setting the individual sliders gives you complete control over your application experience. Using Custom Settings is recommended for advanced users only.
Anisotropic Filtering checkbox	Anisotropic filtering uses a texture filtering technique that blends multiple texture samples together. Selecting Application Preference will result in high quality textures, with a negligible reduction in the application's performance.
Anisotropic Filtering slider	The number of samples taken when anisotropic filtering is performed can vary. By moving this slider to the right, as the number of samples taken increases, the quality of the final image increases significantly. 16X provides extremely detailed, crisp-looking images as a result of the largest number of texture samples possible.
SMOOTH VISION checkbox	SmoothVision (Anti-Aliasing) improves image quality by removing jagged edges from 3D images, resulting in smoother, more natural-looking objects. Selecting Application Preference will result in high quality images, with a negligible reduction in the application's performance.
SMOOTH VISION Performance button	Select Performance for the best possible 3D gaming performance at a slight reduction in 3D image quality. The maximum screen resolution possible will automatically be indicated.
SMOOTH VISION Quality button	Select Quality for the best possible 3D image quality at a slight reduction in 3D gaming performance. The maximum screen resolution possible will automatically be indicated.
SMOOTH VISION slider	SmoothVision (Anti-Aliasing) can be applied using different sample patterns and sample points such as 2X or 4X. Moving this slider to the right increases sampling to provide the most realistic 3D image.

Texture Preference slider	Selecting this decides whether your application should use high quality or high performance textures. Moving the slider to the right delivers the highest quality experience. Moving the slider to the left emphasizes a high performance solution while still providing good visuals.
Mipmap Detail Level slider	This will allow you to choose the texture quality of the mipmaps the application will use. Mipmaps are a collection of different sized textures of the same image. As the user moves closer to a 3D object the image quality should increase, requiring a higher quality texture of the same image. The base mipmap is the highest quality texture, and all subsequent mipmaps are smaller sized textures of the same image. Moving the slider to the right selects a higher quality base mipmap, delivering the highest quality application experience. Moving the slider to the left selects a lower quality mipmap, delivering the highest application performance.
Wait for Vertical Sync	Wait for vertical sync will lower the frame rate of full screen games but reduce the image tearing that can occur with the higher frame rate. Selecting Application Preference allows the application to decide whether or not it should display its frames at the refresh rate of the monitor. Selecting Always Off allows the application to run at its highest possible frame rate, regardless of the monitor's refresh rate which is typically less than the frame rate at which the application will run.
Compatibility Settings button	This button allows you to access advanced settings that can solve compatibility issues for a few specific OpenGL applications.
Defaults	This button allows you to reset the OpenGL settings to default values.

OpenGL[®] Compatibility Settings

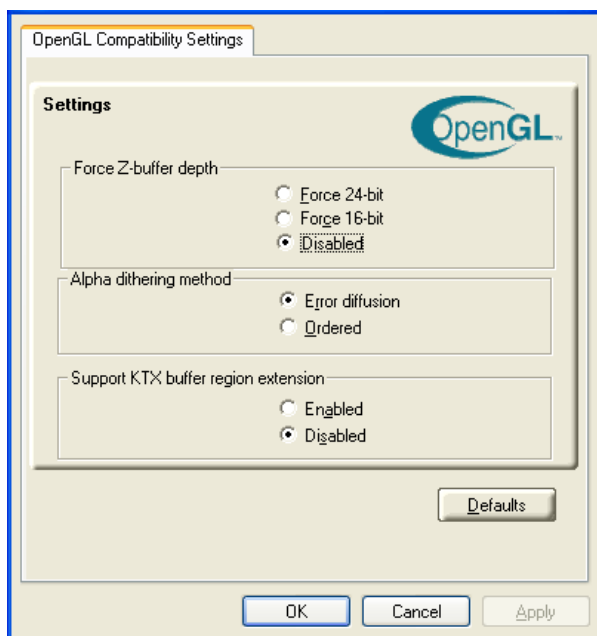

Force Z-buffer depth	This allows you to explicitly set the Z-Buffer depth. Most applications will work best when Disabled is selected
Alpha dithering method	When applications use both dithering and alpha blending, visual artifacts can occur. This option allows you to select how the application should handle both features at the same time. In most cases Error Diffusion will handle this situation quite well, but there are a few cases where selecting Ordered may be necessary
Support KTX buffer region extension	Enabling this feature allows rapid updates of those portions of your screen that have changed. Note that most applications will not be affected by activating this feature
Defaults button	This button allows you to reset the OpenGL Compatibility Settings to default values.

Using TV Out

View your PC's display on a TV

Your RADEON card has TV Out capability. You can attach your card to a TV and monitor at the same time. Or you can connect it to your VCR and record your monitor's display.

TV display is ideal for playing games, giving presentations, watching movies, and browsing the Internet. The following tips will help you get the most out of your TV Out feature.

IMPORTANT INFORMATION for European Customers

Some PC monitors in Europe **cannot** be used simultaneously with TV display. When you enable TV display in Europe, the refresh rate for the monitor and TV is set to 50Hz. Some monitors may not support this refresh rate and could be damaged.

- Please check the documentation supplied with your monitor to see if your monitor supports a refresh rate of 50Hz.

If your monitor does not support 50 Hz (or if you are not sure), then turn off your monitor before turning on your PC when using your TV as a display.

For information on disabling TV display, see [How To Enable/Disable The TV Display on page 25](#).

Some TVs in Europe may use a SCART connection. If you use SCART, please read [Using SCART Connectors for European TVs on page 25](#) before attempting to connect your PC to your European TV.



Connecting to a TV or a VCR

To connect your RADEON 8500 to a TV or a VCR, use an S-Video cable. To connect your RADEON

7500 to a TV or a VCR, use a Composite (RCA) cable. If your TV has cable input only, you can connect your card to your TV through your VCR or an RF modulator (available in most electronics stores).

Connecting Your Video Out to a TV or VCR

- 1 Turn off your PC and your TV (or VCR).
- 2 Ensure your card was installed correctly as per the Getting Started Guide.
- 3 Determine if your TV (or VCR) has an S-Video or Composite video connection.
- 4 Looking at the back of your PC, locate your S-Video Out or Composite Out. Using an appropriate cable, attach one end of the cable to your video out and the other to your TV (or VCR). Refer to the illustration for further help.
- 5 Turn on your PC and your TV (or VCR).

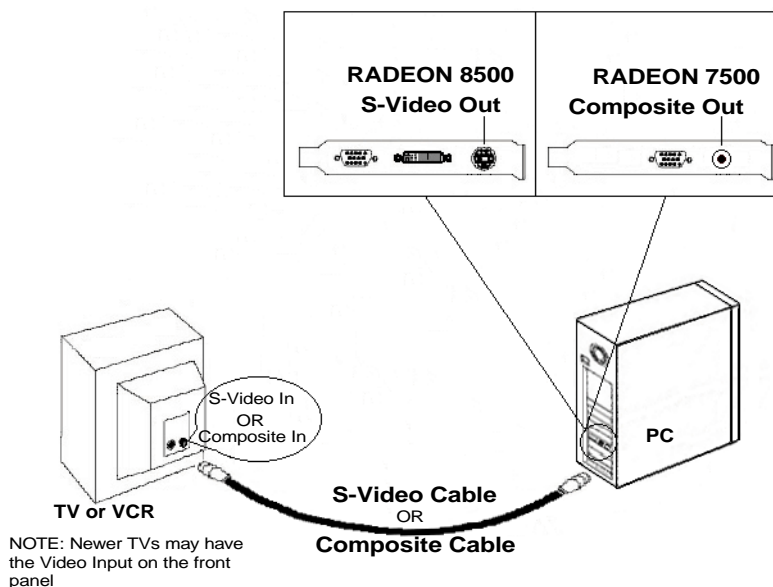

Starting Windows[®] with TV Display Enabled

The TV screen may become scrambled during the initial Windows[®] logo display. This is only a temporary effect and your screen will be restored within a few seconds.

During start up, your RADEON card will go through a sequence of mode settings, during which your TV display will remain blank. This process takes only a few seconds and helps program the TV display.

Using SCART Connectors for European TVs

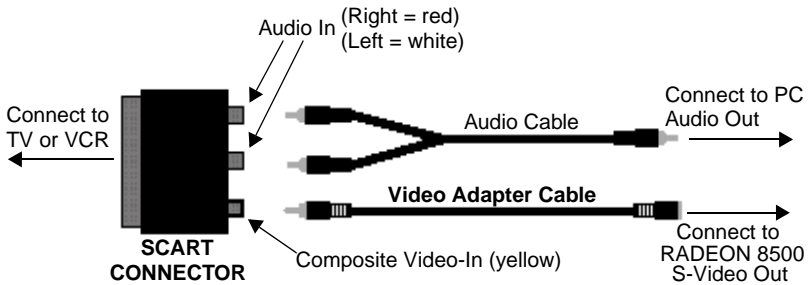

The above illustration shows how to connect your RADEON 8500 to a European TV using the SCART.

The SCART connector supports only the Composite video format, which means you will have to use an S-Video-to-Composite **Video Adapter Cable**. If your European TV **does** support S-Video input, you should connect directly to the TV with an S-Video cable rather than through the SCART.

For the RADEON 7500 you can use a Composite (RCA) cable to connect directly to the SCART.

How To Enable/Disable The TV Display

- 1 Access the Windows[®] **Control Panel**. Double-click **Display**.
- 2 Click on the **Settings** tab and then the **Advanced...** button.

- 3 Click on the **ATI Displays** tab. Click on the **TV** button.
- 4 Click the enable/disable button. 
- 5 Click **OK** or **Apply** to save the changes.

Using and Adjusting TV Out

For information about how to use TV display, right click the **ATI taskbar icon**, point to **Help**, then point to **ATI Television Display**.

How TV Display Cannot Be Used

A TV cannot be left connected to the graphics card if two analog monitors are connected to your RADEON card, even if the TV is off and not enabled in the software.

An analog monitor connected to the DVI-I connector cannot be left connected to your RADEON card when TV out is enabled. In both cases, your RADEON card will become overloaded, resulting in a dim image on all devices.

Using a Monitor vs. Using the TV Display

Using your TV for your PC's display is ideal for playing games, giving presentations, watching movies, and browsing the Internet. However, the display on your monitor may change or look squashed. This occurs because the display adjusts to fit the dimensions of your TV. To correct the monitor's display, use the monitor's control buttons to adjust its display size and position.

Some single frequency monitors may not work with TV display enabled. If you experience problems when TV display is enabled, disable TV display to restore your monitor's display.

Adjusting Monitor Display

The size of the display on your monitor may be smaller and not perfectly centered when you have TV display enabled. These effects are caused by the changes required to provide a proper display on the TV.

Use the controls available on the **Adjustments** tab on the **Monitor Properties** page (accessible by clicking on the **Monitor** button on the **ATI Displays** tab) to adjust the display on your monitor only. Click on the **TV** button to adjust the TV display only.

Viewing Text on a TV

A TV is designed primarily to show moving, rather than static, images. The large dot pitch of a TV (which is fine for moving video) will yield poor quality static images such as text.

The small text sizes commonly used for PC desktops can appear blurred or unclear on a TV. You can compensate for this by using larger fonts.

To Use Larger Display Fonts

- 1 Access the Windows[®] **Control Panel**. Double-click **Display**.
- 2 For Windows[®] XP, click the **Appearance** tab. For Windows[®] 98, Windows[®] Me, Windows[®] 2000, click the **Settings** tab, the **Advanced...** button, then the **General** tab. For Windows[®] NT click the **Settings** tab.
- 3 In the **Font Size** box, select the size you want your displayed fonts to be.
- 4 Click **Apply**. If prompted, click **Yes** to restart your PC.

Reducing Edge Distortion

When using a TV for your PC's display, you may see some edge distortion on the left and right side of your TV screen. This effect depends on your TV and the PC application you are running.

To reduce edge distortion, you can increase the TV display's horizontal size.

To Increase the Horizontal Size

- 1 Access the Windows[®] **Control Panel**. Double-click **Display**.
- 2 Click on the **Settings** tab and then the **Advanced...** button.
- 3 Click on the **ATI Displays** tab.
- 4 Click on the **TV** button.
- 5 Click the **Adjustments** tab.
- 6 In the **Screen Size** section, click on the plus (+) button beside the horizontal arrowheads  to increase the horizontal size of the TV display.
- 7 Click **OK** or **Apply** to save the changes you have made.

You can also reduce edge distortion by increasing the TV's contrast.

To Increase the TV Contrast

- 1 Access the Windows[®] **Control Panel**. Double-click **Display**.
- 2 Click on the **Settings** tab and then the **Advanced...** button.
- 3 Click on the **ATI Displays** tab.
- 4 Click on the **TV** button.

- 5 Drag the **Contrast** slider to the right to increase the contrast.
- 6 Click **OK** or **Apply** to save the changes you have made.

Changing Display Configurations

If you move your PC to a place where you are using TV display only, make sure that you have the TV display feature enabled.

You can set your display resolution as high as 1024x768. However, higher resolutions will result in a virtual desktop. If a TV is your only display device and a higher mode is selected, the display on your TV will disappear.

Using Games and Applications

Some older games and applications may program your RADEON card directly, to run under a specific display mode. This may cause your TV display to turn off automatically or become scrambled (the PC monitor will not be affected). Your TV display will be restored once you exit the game or if you restart your PC.