

# Networked Receiver Controller

## NRC-2.0.1

### Users' Guide

11<sup>th</sup> October 2005

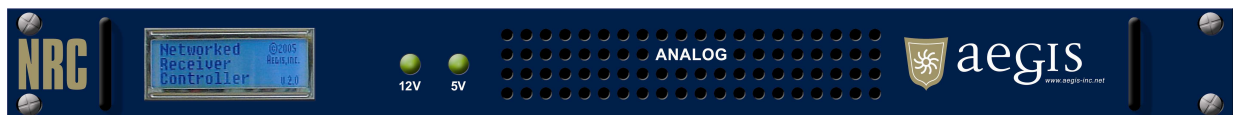

DUNS: 826771508  
CAGE: 1RKF1



[www.aegis-inc.net](http://www.aegis-inc.net)  
Telecom Engineering Services & Products  
8610 Washington Blvd. Suite 213 Jessup, MD 20794  
240.568.9006 240.568.9008 [fax]

## **Proprietary Statement**

All rights reserved. No part of this publication may be reproduced, stored in a retrieval system, or transmitted, in any form by any means, electronic, mechanical, by photocopying, recording, or otherwise without prior written permission.

## **Disclaimer**

Information furnished in this manual is believed to accurate and reliable. However, no responsibility is assumed for its use, or for any infringements of patents or other rights of third parties that may result from its use.

## **Warning**

This equipment utilizes voltages which are potentially dangerous and may be fatal if contacted. Exercise caution when working with the equipment any time the protective cover is removed.

## Table of Contents

General Information.....	5
Channel Architecture .....	6
Audio Data Capture .....	6
Universal Receiver Translation/Abstraction.....	7
Capabilities Summary.....	8
Receiver Controllable Settings .....	8
Client Connection Options.....	8
Remote NRC System Monitoring.....	8
Digitized Audio Channel Output Options.....	8
Receiver Channel POST .....	8
Network Time Protocol (NTP) Client.....	8
Specifications .....	9
System Hardware .....	9
Supported Receivers .....	9
Physical Inputs/Outputs .....	9
A/D Conversion .....	9
Chassis .....	9
Support Software .....	9
Power .....	9
Documentation.....	9
Installation.....	11
Contents .....	11
Hardware Installation.....	12
Step 1: Receiver Audio Signal Termination Type.....	12
Step 2: Rack Mount the NRC unit .....	12
Step 3: Connect Power.....	12
Step 4: Connect Receivers .....	12
Step 5: Optional - Connect an External Clock.....	12
Step 6: Connect to the Network .....	12
NRC Configuration.....	13
Prerequisites:.....	13
Step 1: Connect to the NRC.....	13
Step 2: Change Administrator Password .....	14
Step 3: Configure Network Settings .....	15
Step 4: Set the Time and Date.....	15
Step 5: Configure the Network Time Daemon (Optional).....	16
Step 6: Set the Host Name .....	17
Step 7: Restart the NRC.....	17
Step 8: Configure the NRC for Receivers.....	19
Operation.....	20
Using the NRC.....	20
Starting the NRC.....	20
Interpreting the LCD Display .....	20
Requirements .....	22
Running the NRC Java Client.....	22

Connect to NRC Server Dialog.....	22
The Main Application Window .....	23
Change Receiver Model Dialog.....	31
Change Antenna Model Dialog .....	32
NRC Properties Dialog .....	33
Capture Channel Data Dialog .....	34
Signal Display Dialog .....	35
Appendix A - Receiver Configuration.....	37
BAE Systems WJ-8723.....	37
TEN-TEC RX-331 .....	37
Appendix B - Software Upgrades .....	38
NRC File System .....	38
UPDATE Command .....	39
RESTORE Command .....	39
CLEAN Command.....	40
Upgrade Procedure.....	40

# General Information

The Networked Receiver Controller (NRC) is a single node network device capable of simultaneously:

- controlling and configuring up to 8 attached receivers for data collection
- collecting and digitizing each receiver's analog audio output signal
- formatting and routing the digitized receiver's signal to an attached network client.

A simple diagram of the NRC system is shown below.

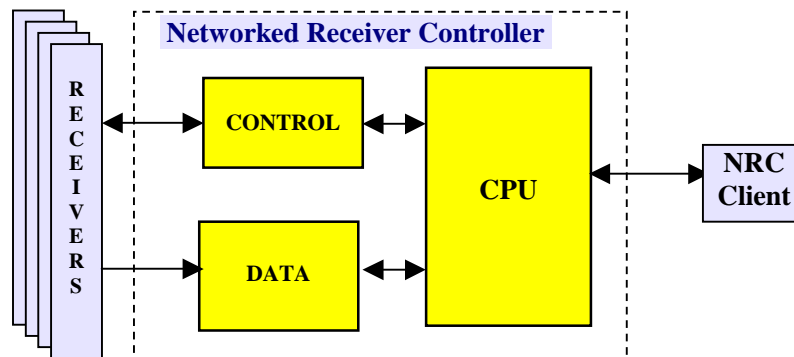

The NRC represents the server portion of a network based client/server architecture. NRC clients connect and disconnect from the NRC via an Ethernet network connection as necessary. When connected, a client has the ability to control, configure and collect digitized audio data from the associated receiver.

Each receiver is physically connected to the NRC via an RS-232 command/control port and an audio input port. The receiver's analog audio output is connected to an A/D where it is sampled at 16 KHz with 16 bit resolution. The resultant digitized audio signal is available for secondary processing and distribution from the NRC as required. The default NRC configuration provides a 4 KHz band-limited, 8 KHz sampled data signal. This digital audio signal is available to the NRC client through a simple packet based protocol, which aggregates samples into a single data packet for forwarding to the client.

The NRC server is a 1 rack unit chassis system with the following front and back views.

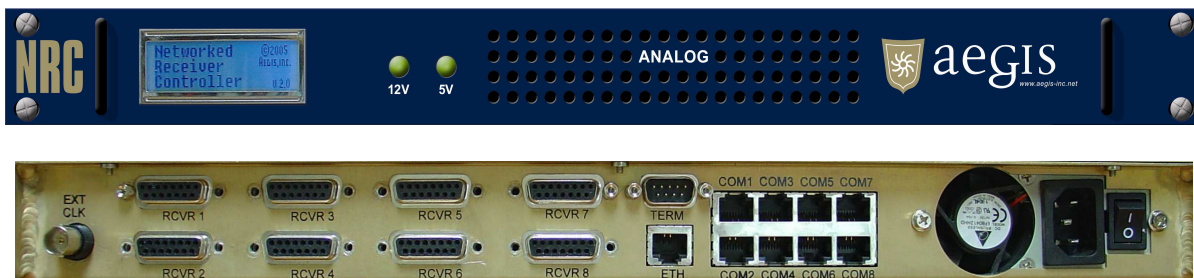

In this chapter, the various features of the NRC will be discussed.

# Channel Architecture

A channel defines a virtual connection between a client application and a receiver connected to the NRC.

There are two types of channel connections which can be established to a receiver; a Primary connection and a Piggy-back connection.

1. A Primary Connection
  - a. A Primary connection is established with a receiver when the receiver is free of any other client connections.
  - b. A Primary connected client has full access and control of the receiver and its resources.
2. Piggy-back Connection
  - a. A Piggy-back connection is established with a receiver when the receiver currently has one or more other clients already attached to it.
  - b. A Piggy-back connected client cannot change any of the receivers settings, although it can view the current receiver settings, and capture and format the receivers audio output.

The NRC supports one Primary connection per receiver and multiple Piggy-back connections, with the NRC able to support an aggregate of 64 simultaneous Primary/Piggy-back connections.

## Audio Data Capture

The NRC uses an 8 channel PCI-based Analog/Digital converter card to digitize each receiver's audio output signal. Each receiver's audio signal is digitized into 16-bit samples (14.8 effective bits/sample) at a sampling rate of 16 KHz.

Each client attached to the receiver can receive a copy of this sampled audio data through a simply packet based protocol, and can specify:

- the number of samples to be contained within a data packet
- the effective sampling rate of the data - either 8 KHz or 16 KHz.
- the audio data filtering option – 4 KHz LPF ON or OFF, and
- the packet time stamping – TAI64N ON or OFF

Sampling synchronization is achieved either via the NRC's internal high precision crystal oscillator circuitry or by a user provided external clock signal into the NRC's EXT CLK port. The user external clock signal, if used, should be a 50% duty cycle (TTL) square wave operating at a frequency of 16 KHz.

## Universal Receiver Translation/Abstraction

The NRC abstracts the user from each receiver's proprietary low-level communications protocol by presenting a common receiver translation software tasking interface to the user. This common software interface allows the user to task the receivers at a logical level without the need to worry about how to implement this tasking. This allows a wide range of different receivers to be tasked via the NRC in the same manner regardless of the number, model or configuration of the receivers.

This receiver hardware abstraction allows the NRC:

- To be easily programmed to connect to almost any receiver with an audio output.
- To accommodate being connected to different receiver models simultaneously.
- To control the major functions of any receiver through a simple tasking protocol.
- To provide receiver vendor independence, allowing the user to utilize the most appropriate receiver for any given application.

Receiver XML configuration files are used to define the different receiver protocol profiles. This allows new receiver support to be added to the NRC relatively quickly and simply by generating and integrating a new receiver XML profile file.

A list of currently supported receivers can be found in the *specifications* section of this document, with additional receiver support able to be provided upon request.

# Capabilities Summary

<p><b>Receiver Controllable Settings</b></p> <ul style="list-style-type: none"> <li>• Frequency</li> <li>• Detection Mode</li> <li>• IF Bandwidth</li> <li>• AGC mode</li> <li>• BFO</li> <li>• Reset / Reboot</li> <li>• Pass native commands to the receiver             <ul style="list-style-type: none"> <li>○ By-pass the generic receiver interface and send the receiver proprietary commands</li> </ul> </li> <li>• Receiver Memory Interface Support             <ul style="list-style-type: none"> <li>○ Save, recall and query receiver configuration memory settings</li> </ul> </li> </ul>	<p><b>Client Connection Options</b></p> <ul style="list-style-type: none"> <li>• Up to 64 simultaneous client connections</li> <li>• Primary - connection to a receiver when it is free             <ul style="list-style-type: none"> <li>○ Full control and access to the receiver, the audio data and its configuration options.</li> </ul> </li> <li>• Piggyback - connection to a receiver that already has a Primary client attached             <ul style="list-style-type: none"> <li>○ Limited connection privileges</li> <li>○ No control of the receiver but visibility of the receiver's settings.</li> <li>○ Full access to the receiver's audio configuration and data options.</li> <li>○ Can be promoted to Primary connection status if the existing Primary client disconnects</li> </ul> </li> </ul>
<p><b>Remote NRC System Monitoring</b></p> <ul style="list-style-type: none"> <li>• View current state of receiver configurations and attached clients</li> <li>• View health and well being of NRC</li> </ul>	<p><b>Digitized Audio Channel Output Options</b></p> <ul style="list-style-type: none"> <li>• Sampling Rate: 8 KHz (default), 16 KHz</li> <li>• Filtering: 4 KHz LPF (default), None</li> <li>• Samples/Data Packet: 640 (default), 128-4096</li> <li>• Packet Time Stamping: None (default), TAI64N</li> <li>• Retune Samples skipped: 350 (default), variable</li> <li>• Collection Control: Start / Stop</li> </ul>
<p><b>Receiver Channel POST</b></p> <ul style="list-style-type: none"> <li>• A power on self test is used to verify each receiver's RS-232 control and audio signal paths to reduce the possibility of incorrectly connecting receiver cables</li> </ul>	<p><b>Network Time Protocol (NTP) Client</b></p> <ul style="list-style-type: none"> <li>• The NRC is configurable to obtain and synchronize time with an NTP Server</li> </ul>



# Specifications

<p><b>System Hardware</b></p> <ul style="list-style-type: none"> <li>• CPU System:             <ul style="list-style-type: none"> <li>○ PC x86 SBC based system</li> </ul> </li> <li>• Operating System             <ul style="list-style-type: none"> <li>○ Linux OS, Compact Flash based file system</li> </ul> </li> </ul>	<p><b>Supported Receivers</b></p> <ul style="list-style-type: none"> <li>• DRS WJ-8723 HF Receiver</li> <li>• Ten-Tec RX-331HF Receiver</li> <li>• Additional Receivers available upon request</li> </ul>
<p><b>Physical Inputs/Outputs</b></p> <ul style="list-style-type: none"> <li>• Number of controllable receivers: 1 to 8</li> <li>• Connections/Receiver             <ul style="list-style-type: none"> <li>○ 1x Audio Input Port (DB-15)</li> <li>○ 1x Control Port (RJ-45, RS-232)</li> </ul> </li> <li>• Network Port (RJ-45, 10/100 Base-T Ethernet)</li> <li>• Remote Serial Terminal Port (DB-9, RS-232)</li> <li>• External A/D Card Clock Input (BNC, TTL)</li> </ul>	<p><b>A/D Conversion</b></p> <ul style="list-style-type: none"> <li>• Sample Resolution:             <ul style="list-style-type: none"> <li>○ 16-bit (14.8 effective bits)</li> </ul> </li> <li>• Channel Sampling Rate: 16 KHz</li> <li>• Pre A/D Channel Gain: 1 (default), 2, 4, 8</li> <li>• Internal Sampling Clock             <ul style="list-style-type: none"> <li>○ Accuracy: 10ppm 0-85C</li> <li>○ Stability: 10ppm 0-85C</li> </ul> </li> <li>• External A/D Card Clock Input             <ul style="list-style-type: none"> <li>○ 16 KHz TTL square-wave: 50% duty-cycle</li> <li>○ Optional input to provide external sync</li> </ul> </li> <li>• Analog Signal Input             <ul style="list-style-type: none"> <li>○ Range: -5V to +5V</li> </ul> </li> <li>• Types: Single-Ended / Differential</li> </ul>
<p><b>Chassis</b></p> <ul style="list-style-type: none"> <li>• 1RU (19"x 20"x1.75"), fits standard 19" racks</li> <li>• Jonathan 375QD-20 slide mounts fitted</li> <li>• Weight: 10lbs</li> <li>• Ventilation: Positive internal pressure</li> <li>• Internal Heating Profile:             <ul style="list-style-type: none"> <li>○ Fully loaded NRC, temperature increase &lt;+15F above ambient</li> </ul> </li> </ul> <p><b>Note:</b> Chassis not recommended to be solely mounted in 19" rack by bolts through the chassis' front panel - rack slides or rack shelving recommended.</p>	<p><b>Support Software</b></p> <ul style="list-style-type: none"> <li>• Java and C++ programming APIs</li> <li>• Example Client Program</li> <li>• Remote software upgrade capability</li> </ul>
<p><b>Power</b></p> <ul style="list-style-type: none"> <li>• Nominal power: 25 W</li> <li>• Max power: 32 W</li> <li>• Operating Range:             <ul style="list-style-type: none"> <li>○ 100-240 VAC, @47-63Hz (Auto-Select)</li> </ul> </li> </ul>	<p><b>Documentation</b></p> <ul style="list-style-type: none"> <li>• Programmers Manual</li> <li>• Users Manual</li> <li>• Protocol Interfacing Document</li> </ul>



# Installation

## Contents

The following is a list of items delivered with the NRC unit.

- Networked Receiver Controller unit (1)
- Power cable (1)
- Receiver Control Cables (8)
  - For BAE Systems WJ-8723 units - 8x DB25M-RJ45 - grey cables
  - For TenTec RX331 units - 8x DB25M-RJ45 - black cables
- Receiver Audio Cables (8)
  - For BAE Systems WJ-8723 - 8x DB15M/DB15M audio cables
  - For TenTec Rx331 units - 8x DB15M/DB15M audio cables
- Users' Guide (1)
- Programmers' Guide (1)
- Documentation and SDK CD (1)

# Hardware Installation

## Step 1: Receiver Audio Signal Termination Type

The NRC supports both differential and single-end audio signals, with the factory system default being configured to support Differential Mode.

If Single-End mode is required, proceed as follows:

1. Ensure the NRC is powered off
2. Remove the top cover of the NRC.
3. Locate the two banks of 4x DIP switches, **D1** and **D2**.
4. Set all switches to the ON position for single-ended operation.
  - a. Conversely, set each switch to the OFF position for differential operation.
5. Replace the cover and install the screws.

**Note: The NRC software's default configuration is to support Differential Mode, and hence it must also be configured to match the desired audio signal state. The *NRC Configuration* section will address this requirement.**

## Step 2: Rack Mount the NRC unit

The NRC chassis supports Jonathan Type 375QD-20 chassis slides and these are recommended for rack mounting the NRC where necessary.

**Note:** It is not recommended that the NRC Chassis be solely mounted in 19" rack by bolts through the chassis' front panel - rack slides or rack shelving recommended.

## Step 3: Connect Power

The supplied power cable should connect the power adapter on the back panel power socket of the NRC. The NRC power supply is an auto-sensing unit which can accept voltages between 100-240VAC @47-63Hz.

## Step 4: Connect Receivers

Each brand and model of receiver has specific configuration and installation instructions that must be followed prior to operation with the NRC. Please refer to Appendix A.

## Step 5: Optional - Connect an External Clock

If an external clock connection is desired for A/D synchronization, use a coaxial cable to connect a 16 KHz TTL (50% duty cycle) external clock signal to the EXT CLK port on the NRC's back.

The NRC's default configuration uses the internal clock and hence the system needs to be re-configured to use an external signal for A/D synchronization. This can be achieved after the Hardware Installation through the NRC Java client's "Global NRC Properties" dialog, or via the programmers' SDK.

## Step 6: Connect to the Network

A Cat-5 cable should be used to connect between the ETH port on the back panel of the NRC and the local area network.

# NRC Configuration

## Prerequisites:

In order to successfully configure the NRC for operational use, the installer must have access to:

- a. a terminal emulation program
  - i. Before using it on the network the NRC must be properly configured, by running a configuration utility on the NRC through a remote terminal session. This requires connecting serially to the NRC from another computer. The operating system of the computer is not important as long as it has a compatible terminal emulation program. For example, most Linux distributions contain **minicom** and the Windows systems contain **HyperTerminal**, both of which are appropriate for this application requirement. In addition, the computer must contain an available serial port.
- b. A computer machine on which the NRC java client can be run
  - i. In order to configure the NRC to understand the type of attached receivers, the supplied NRC Java client needs to be able to run. This computer needs to be on the same network as the NRC unit so it can attach to the NRC.

## Step 1: Connect to the NRC

Before using it on the network the NRC must be properly configured, by running a configuration utility on the NRC through a remote terminal session. This requires connecting serially to the NRC from another computer. The operating system of the computer is not important as long as it has a compatible terminal emulation program. For example, most Linux distributions contain **minicom** and the Windows systems contain **HyperTerminal**, both of which are appropriate for this application requirement. In addition, the computer must contain an available serial port.

The following steps describe the remote terminal connection process:

1. Power on the NRC
2. Connect a DB9 null modem cable from the remote terminal port on the NRC to a serial port on the computer.
3. Start the terminal emulation application on the computer.
4. Specify correct terminal settings on the terminal emulation application. Please refer to the application documentation for instructions on how to make these settings.
  - COM Port: *use the serial port on the computer that connects to the NRC.*
  - Bits per second: 9600
  - Data bits: 8
  - Parity: none
  - Stop bits: 1
  - Flow control: None
  - Terminal emulation: vt100
5. Activate the terminal (press Enter a few times). You may need to send a terminal *break* if this doesn't work.
6. Once this terminal is active the linux system and NRC boot-up messages will be echoed to the remote terminal. Once the NRC system has finished booting, a user login prompt will appear.

If this is the first time the NRC has been turned-on, once the NRC has completed its initial system boot-up process, the NRC system LCD graphics files will be uploaded into the LCD display. The NRC's LCD display will indicate which LCD memory location the current image is being uploaded into and once this image upload process is finished, the LCD display will be activated and display 8 channel status windows above the status message "www.aegis-inc.net".<sup>1</sup>

7. Once the NRC has reached this stage, the user should then login to the NRC via the remote terminal.

**Note: If you login before the NRC system has completed the LCD image file upload and the LCD display isn't displaying the 8 channel status icons, the NRC file system will be in a read-only state. This will mean that none of the NRC configuration changes available through the NRC Configuration Utility will be able to be changed.**

8. Login as *root*, with the Aegis shipped *root* password set to *aegisnrc*. The option on how to change the password will be discussed shortly. Once logged in, the following NRC Configuration Utility will appear.

```
Networked Receiver Controller
Configuration Utility

(c)2005 Aegis, Inc.

1 ) Change administrator password
2 ) Configure network settings
3 ) Set time and date
4 ) Set NRC name
5 ) Configure NTP daemon

R ) Restart NRC
-----
Selection:
```

## Step 2: Change Administrator Password

It is important to change the root password immediately to secure the machine. Select option *1* and follow the screen prompts to enter a new password. Below is a screen sequence example when the password is changed.

```
Change administrator password:

Do you really want to do this (y/N)? y

Changing password for root
Enter the new password (minimum of 5, maximum of 8 characters)
Please use a combination of upper and lower case letters and numbers.
Enter new password: Nrc-001
Re-enter new password: Nrc-001

password changed
```

**Important: don't forget or lose the root password.** Doing so will make it impossible to administer these settings or to make any upgrades or changes to the NRC. In the case that this does occur, call Aegis, Inc. for recovery information.

---

<sup>1</sup> See "Interpreting the LCD display" for details

### Step 3: Configure Network Settings

Before the NRC can be accessed from the network, it must be assigned a network address. Select option 2 to configure the network options.

Below is a screen sequence example as the IP address settings are configured.

```
Configure network settings:

Present settings for device eth0:
Local IP address = 192.168.1.159
Netmask = 255.255.255.0
Broadcast address = 192.168.1.255
Network address = 192.168.1.1

Enter the following new values.

IP address (enter "DHCP" for DHCP dynamic IP addressing): 192.168.1.175
Subnet mask: 255.255.255.0
Broadcast address: 192.168.1.255
Network address: 192.168.1.1

New parameters for network device eth0:
IP address = 192.168.1.175
Subnet mask = 255.255.255.0
Broadcast address = 192.168.1.255
Network address = 192.168.1.1

Accept these settings (y/N)?y

Network device successfully configured.

You must restart the NRC in order for these changes to take affect.
```

The following IP properties are needed to configure the NRC:

1. IP address  
The IP address of the NRC if one has been assigned by the network administrator or "DHCP" if dynamic network addressing is supported in the network.
2. Subnet mask  
Obtain the correct value from your network administrator or press *Enter* for none.
3. Broadcast address  
Obtain the correct value from your network administrator or press *Enter* for none.
4. Network address  
Obtain the correct value from your network administrator or press *Enter* for none.

These changes will take effect once the NRC needs to be restarted. It is probably easiest to make all the NRC system changes and then restart the NRC at the completion of the changes.

### Step 4: Set the Time and Date

Select option 3 to set the correct time and date.

Below is a screen sequence example as the time and date are configured.

```
Current time: Wed Jul 6 15:24:35 UTC 2005

Please enter new time and date in month,day,hour,minute,year format
```

(mmdhhmmyyyy) : 070615292005

Time and Date set to: Wed Jul 6 15:29:00 UTC 2005

Please note the time/date format - month/day/hour/minute/year (MMDDHHMMYYYY).  
For the above example, if it was 3:29pm (15:29) on July 6, 2005  
If you enter return without entering a new time string the time and date will not be changed.

## Step 5: Configure the Network Time Daemon (Optional)

You can optionally configure the NRC to use the Network Time Protocol daemon (NTPd) to keep the NRC system clock synchronized with other machines on the network.

Typical NTPd configuration requires only the IP address of a time server. This can be provided by either another machine on the local network with NTPd already configured, or from one of many free public NTP servers. Detailed information about NTP and a Public NTP Server list can be found at <http://www.ntp.org>.

Select option 5 to configure the basic NTPd option, which displays the following menu.

```
Networked Receiver Controller
NTP Configuration Utility

1 ) Modify NTPd config file
2 ) Add ntpd to startup

B ) Go back to NRC main menu

-----
Selection:
```

To modify or view the current NTPd configuration file select *1*. Below is a screen sequence example as the NTPd is configured.

```
Current /etc/ntp.conf:
# File generated by Aegis configuration
# No one except the servers can access the ntpd service:
restrict default ignore
restrict 192.168.1.149 nomodify noquery notrap
server 192.168.1.149

Change ntpd configuration? (y/N) y
Restrict remote access to ntpd? (Y/n) y

NTP server address: 192.168.1.146
Additional server parameters:

Test '192.168.1.146' now? (Y/n)y
Testing '192.168.1.146'...

Looking for host 192.168.1.146 and service ntp
host found : 192.168.1.146
server 192.168.1.146, stratum 3, offset 0.065870, delay 0.02568
 6 Jul 16:31:01 ntpdate[1032]: adjust time server 192.168.1.146 offset
0.065870c

'192.168.1.146' tested ok.
Add another server? (y/N) n
```



After the above change sequence is complete set the ntp.conf file contains the following:

```
restrict default ignore
restrict 192.168.1.146 nomodify noquery notrap
server 192.168.1.146
```

Once the ntp information has been configured the ntp daemon needs to be started and added to the server startup. Select option 2 from the NTP Configuration Utility. Below is a screen sequence example as the NTPd daemon is enabled.

```
Add ntpd to server startup? (y/N) y
Added to startup. Start ntpd now? (Y/n) y

Starting ntpd .....
```

The ntp daemon can be stopped and removed from the start-up by re-selecting option 2 from the NTP Configuration Utility, which toggles to now show a remove ntpd option:

```
2 ) Remove ntpd from startup
```

Below is a screen sequence example as the NTPd daemon is disabled and removed from the server startup.

```
Remove ntpd from server startup? (y/N) y

Removed from startup. Kill all running ntpd processes? (Y/n) y
Okay, killed.
```

## Step 6: Set the Host Name

Select option 4 and enter a name for this NRC. This name should uniquely identify this NRC. Below is a screen sequence example as the NRC name is changed.

```
Set NRC name:

Current NRC name: nrc
Change NRC name (y/N)? y

Enter new NRC name: nrcl
Change NRC name to nrcl ? y

NRC name changed
```

## Step 7: Restart the NRC

Select option R to restart the NRC. The NRC has two restart options – a system halt and a system reboot. The NRC needs to be restarted to activate all the changes made through this configuration utility. Once the system is restarted, the NRC will be accessible from the network.

The systems reboot and halt operations both shutdown the NRC system, with the reboot command initiating a follow-on system restart.

Below is a screen sequence example as the NRC is reboot.

Restart NRC:

Halt or Reboot (h/R)? r

Reboot system. Do you wish to proceed (y/N)? y

Proceeding with shutdown process.

Terminated

~ # flushing ide devices: hdd

Restarting system.

**Note: Normal operation is suspended in the NRC when using the remote terminal. Be sure to restart the NRC after using the remote terminal to resume normal operation.**

## Step 8: Configure the NRC for Receivers

From a computer, start the NRC Java Client. See the section, *Using the NRC Java Client Application* for details on requirements and running the NRC Java Client.

### Configure the signal termination type and DAQ Channel Gain

After connecting to the NRC from the NRC Java Client, right click on the NRC node, identified by its machine name or IP address. Click Properties and the “NRC Properties” dialog will appear. Configure the necessary options.<sup>2</sup>

Ensure that the following NRC software options match the previously set hardware options:

- Conversion Clock Source (Internal or External)
- Audio Input Type (Differential or Single-Ended)

The pre-A/D converter receiver gain for each receiver channel is also set through this dialog, with the default being a gain of 1 with gains of 2, 4 and 8 also being available.

Note: When changes are made to any of these NRC attributes, all NRC channels will be stopped, reconfigured and restarted, disrupting any current processing on any of these channels.

### Assign receiver models to each channel

Connect to the first channel that is attached to a receiver. Right click on the channel node and select “Change receiver model.” The “Change receiver model” dialog will appear.<sup>3</sup>

Select the desired receiver model from the list. Press Enter or click the Enter button and the dialog will be dismissed. Confirm the change by noting the contents of the tree.

Repeat this process for each channel that is attached to a receiver.

Note:

It is important to ensure the correct format receiver control cables are used to connect the receiver to the NRC unit. Installing the wrong format cables will prohibit the NRC from successfully communicating with the receiver.

eg. Trying to use TenTec RX331 receiver format control cables to connect to WJ-8723 receiver will fail as they have different signaling requirements.

Congratulations. The setup process is now complete. The NRC Java Client application can now be used to connect to the NRC.

---

<sup>2</sup> See “*Using the NRC Java Client Application – NRC Properties dialog*” for further details.

<sup>3</sup> See “*Using the NRC Java Client Application – Change receiver model dialog*” for further details

# Operation

## Using the NRC

### Starting the NRC

After pressing the power button, the NRC may take up to 60 seconds to initialize and be ready for operation. Initially the display will show “Networked Receiver Controller” and NRC version. When initialization is complete, the NRC LCD display will be activated and display 8 channel status windows above the Aegis status message “www.aegis-inc.net”.

### Power-On Self Test (POST)

A Power-On Self Test (POST) is a receiver connection integrity test is an integral part of the NRC. During this test, the control and audio connections for each channel are checked for proper connection and operation to and with the NRC.

The POST configures each NRC attached receiver to generate and output a unique frequency analog test tone, which is then digitally processed to ensure it is at the expected frequency. If the NRC is able to successfully configure the receiver and process the audio test tone then the receiver is deemed to have passed the POST and be available for use. The success or failure of each channel’s POST test is reported on the LCD display<sup>4</sup>.

This POST is run on a per-channel basis when:

1. A new receiver type is attached to the NRC and configured for the channel.
2. A receiver is powered on or otherwise comes online, including when the NRC is initially turned on or re-boot.
3. A receiver is “reboot” via the Java GUI.

Note: If the receiver for some reason goes *off-line* and then returns *on-line* while there is at least one client already connected to that receiver, the POST will not run until all attached clients disconnect from that receiver channel. This allows the NRC to run the POST in the background only when the receiver is free. When a POST is running, clients will be inhibited from connecting to the channel until the POST test is completed (~1-2sec).

### Interpreting the LCD Display







The LCD display contains important information regarding the status and use of the NRC. During normal operation, the LCD will display a symbol reflecting the current status of each channel, with the display’s left-most symbol being channel 1’s status across to channel 8’s status on the right hand side.



Only one symbol is displayed to reflect the status of a given channel and hence the symbols have an inherent priority and hence only the highest priority symbol will be displayed.

---

<sup>4</sup> See “Interpreting the LCD Display” for details

The LCD display symbols are listed – from highest to lowest priority, along with their meaning in the following table.

-  The NRC is not configured for this channel; Configure the correct receiver for this channel.  
The receiver attached to this channel is currently offline.
-  - Caused when the NRC is unable to communicate with the receiver via the RS-232 connection.  
- Check the receiver and its NRC connections, whether the receiver is powered on, and whether the receiver is operational or needs to be reset or needs the power cycled.  
The receiver attached to this channel failed an integrity test.
-  - Caused when a receiver is able to communicate with the NRC, but fails to respond as expected when tuned to provide a self-test audio tone to the NRC unit.  
- Check the receiver's RS-232 and audio connections to the NRC match and then reboot/re-power the receiver and/or the NRC.
-  A client is currently connected to this channel and is receiving data from this channel.
-  A client is currently connected to this channel.
-  This channel is fully functional and available for use.

When the NRC is configured and operating correctly symbols  ,  and  will be most often displayed.

## Using the NRC Java Client Application

### Requirements

The NRC Java Client application can be executed on any computer that supports the Java 2 platform and is connected to the network. It is most thoroughly tested with the Sun Java 2 Platform, Standard Edition (version 1.4), which can be downloaded freely from <http://java.sun.com/j2se/1.4.2/download.html>. It is recommended that the newest version of the Java 2 Platform be used. Consult your system administrator for more information on running Java on your system.

### Running the NRC Java Client

On systems that support automatic execution for known file types, the application can be run by double-clicking the NRCJavaClient.jar file.

Otherwise, from a command prompt, navigate to the directory that contains this file. Type: `java -jar NRCJavaClient.jar` and press Enter. If the java.exe application is not found in a path pointed to by the PATH environment variable, specify the path on the command line.

### Connect to NRC Server Dialog

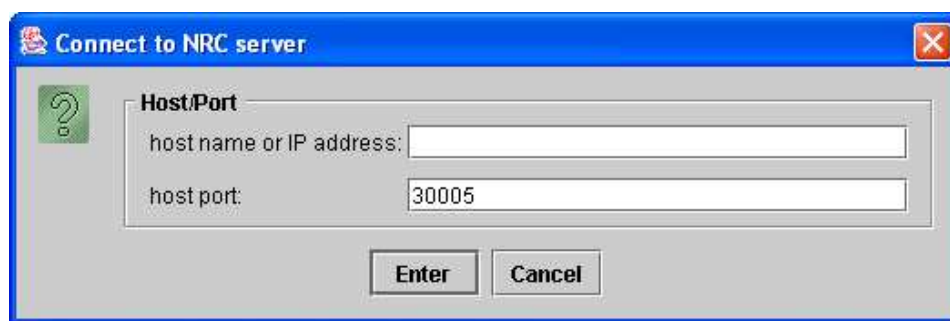

The first order of business is to make a network connection with an NRC server. This can be done with knowledge of the IP address or DNS-resolvable hostname given to the NRC during the software configuration. The NRC Java Client can attach to multiple NRC servers or the same NRC server multiple times.

When starting the NRC Java Client, the “Connect to NRC server” dialog box appears. This dialog can be raised at any time by clicking the “Connect to NRC server” button on the toolbar of the main application window.

Enter the IP address or hostname of the NRC server and the port number in this dialog and click the Enter button or press the Enter key.

Note: the default port number is automatically generated before the dialog appears.

## The Main Application Window

The window is split into several functional areas. On the left is the tree, and to the right is the content panel. A toolbar is found at the top, and a status bar can be seen at the bottom of the window. Each of these components is discussed in detail below.

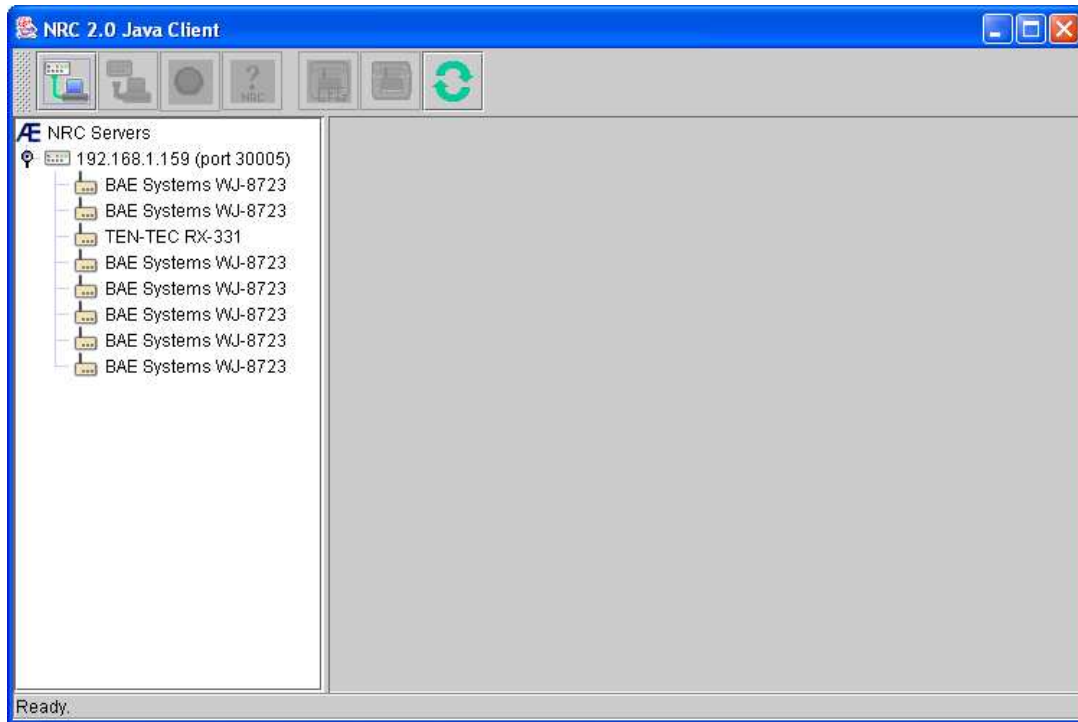

## Tree

The tree control is found on the left-hand side of the main application window and functions much like the similar control found in file browsing applications. Each component in the tree is referred to as a node. Nodes are organized in a hierarchical fashion. The tree is navigated by clicking the various nodes in the tree. When a node is clicked, the content panel is updated to provide detailed information and control options corresponding to that node in the tree. In addition, some of the toolbar buttons are enabled or disabled to reflect their use when that node is selected.

Each time a connection is made with an NRC server, a node is inserted in the tree below the “NRC Servers” node representing the connection to that server. The title of the node is the IP address or hostname entered. Below this NRC node, several “channel” nodes are inserted. Each node represents a channel of that NRC server.

### *Channel Nodes*

Channel nodes provide some immediate information on the current state of that channel. The title of each node is the model name of the receiver attached to that channel. The NRC has 8 channels and these are represented with the top node being tied to channel 1, node 2 tied to channel 2, and sequentially down to node 8 being tied to channel 8. If there is no receiver configured for that channel, the node will read, “No receiver attached.”

In addition, the color of the node shows the connection state of that channel.

- Gray: no receiver is attached to that channel
- Beige: the channel is free
- Green: a primary client is attached to that channel with full access privileges
- Red: the channel is in use by another client
- Yellow: a piggyback client is attached to that channel with limited privileges

## Content Panel

The content panel contains a display corresponding to the current selection in the tree. This display typically provides information regarding the tree selection as well as controls that can be used to modify this information. The following sections discuss the content panels displayed when the various node types are selected.

### *“NRC Servers” Node*

There is no function for this node currently, so the content panel appears blank when this node is selected.

### *NRC Server Node*

Each NRC server node represents an existing connection between the client and an NRC server. When a server node is selected, “Monitor” information will be displayed in the content panel. The monitor information provides a scrollable window summary of the NRC's current status which includes:

- NRC Server’s Identification information
  - name, IP address
- NRC Server’s Configuration information
  - Clock Status, Channel Gain settings, NTP status.

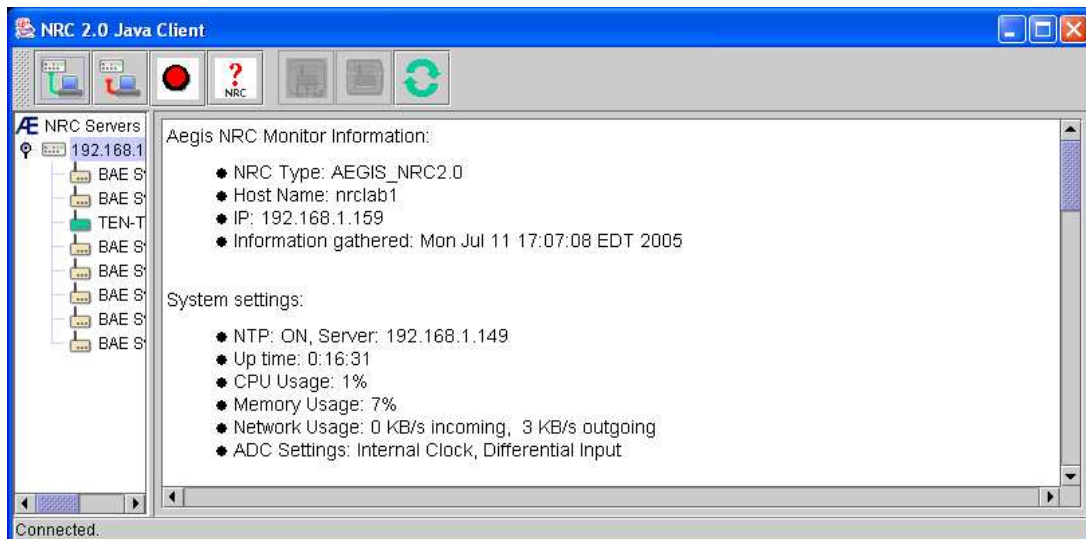



- NRC Server's Performance information
  - Length of time the NRC server has been running - uptime
  - Current CPU usage - average over the last 5 seconds
  - Current memory usage
  - Current network usage (outgoing and incoming data)

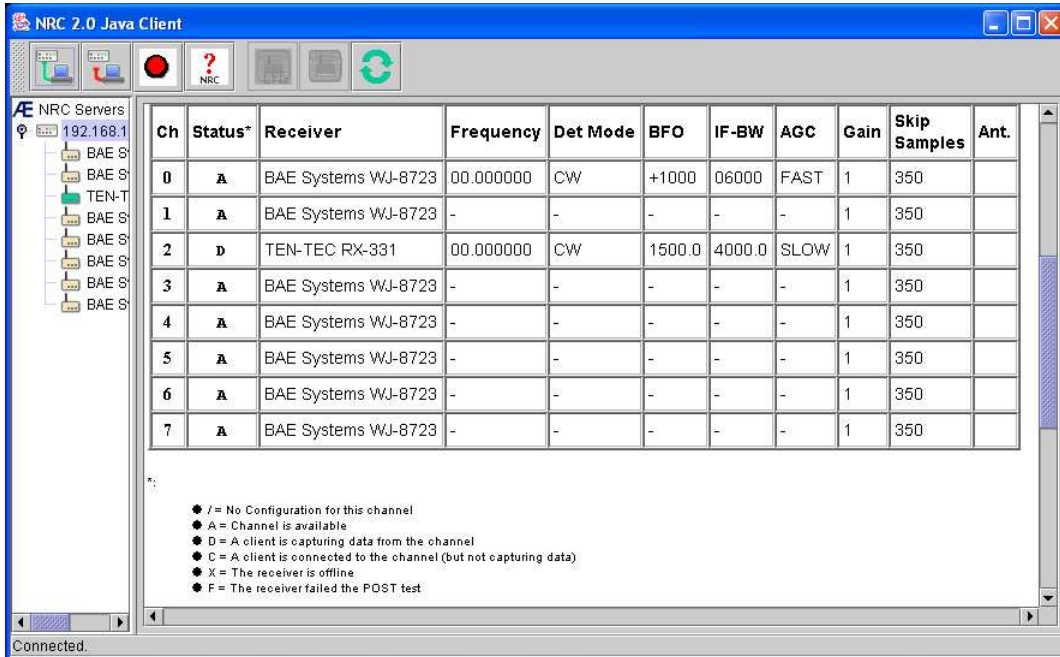

- NRC Channel Summary Information
  - Summary of each channel's current status and receiver configuration
  - Summary of all clients currently connected to each channel

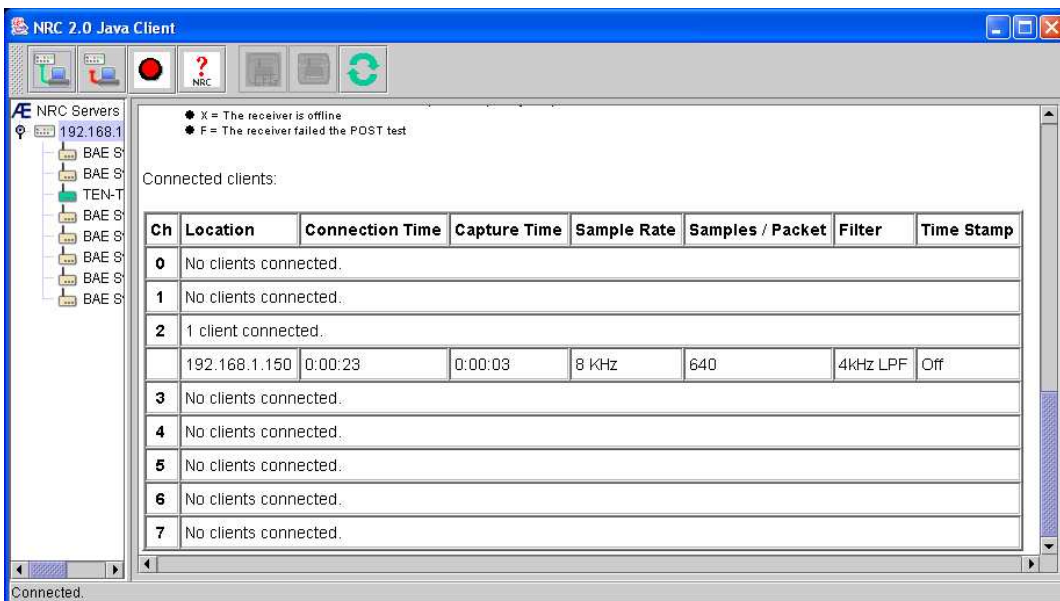

## Channel Node

Most of the functionality of the NRC Java Client is provided in the content panel when a channel node is selected in the tree. This panel is separated into three areas:

- **Connect state**  
Positioned at the top, this area gives the current connection state of the channel and the ability to connect to, piggyback to or disconnect from the channel, if applicable. If the channel is connected to another client, the network address of that client appears. If the client is currently piggybacking the channel, the network address of the primary client is shown.

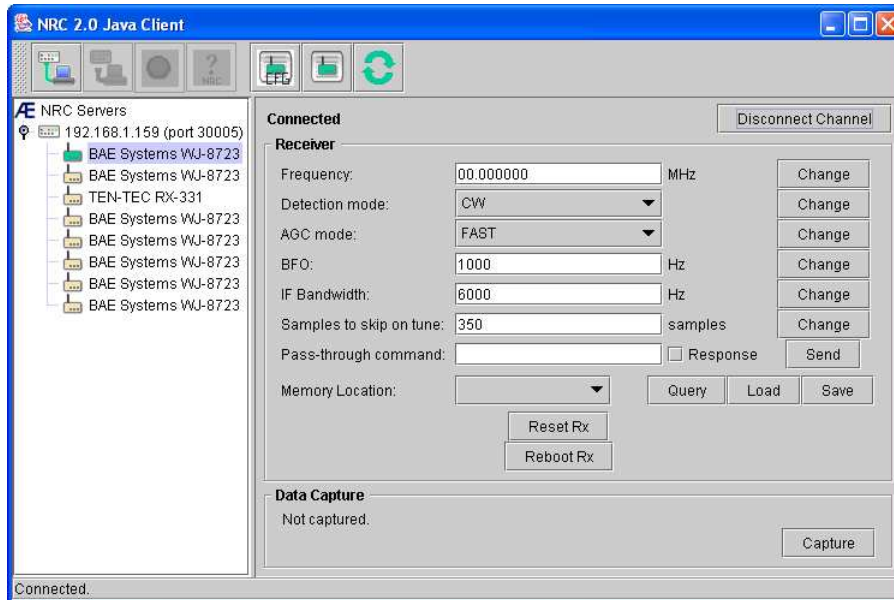

- **Receiver**
  - **Receiver Configurable Options**  
The receiver section contains the current state of the configurable receiver parameters for the receiver attached to the channel - frequency, detection mode, AGC mode, BFO, IF Bandwidth. Each of these parameters can be changed by entering the new value in the corresponding field and then pressing Enter or clicking the corresponding Change button. NOTE: You must hit the change button for new pull down options in Detection Mode or AGC Mode to take effect.
  - **Samples to skip on tune**  
This indicates the number of audio samples to discard when changing receiver parameters, and ensures the output signal reflects that associated with the changed values.
  - **Receiver Memory Interface**  
The memory location interface allows the receiver's internal memory locations to be accessed and receiver parameters to be queried, loaded or saved.

- Query – This button allows you to query the receiver to find out which parameters are stored in memory. Some receiver types also support the ability to display what values are currently stored at a specific memory location. Below is a query on a WJ receiver.

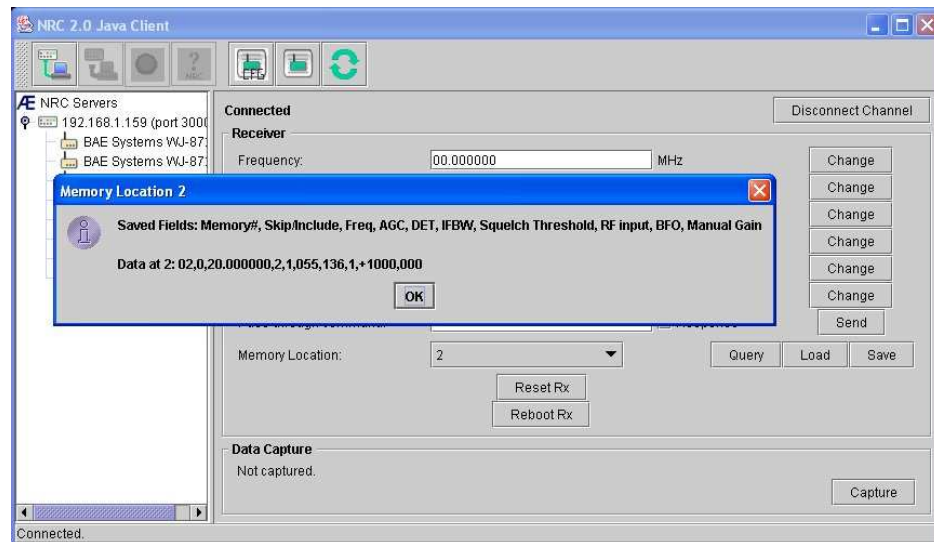

- Load – This option loads the receiver configuration from the specified memory location into the receiver’s current configuration. If nothing is stored at the memory location the behavior of this operation is dependant on the type of receiver. Some receivers may ignore the command or load a default configuration, or for example.
- Save – This option saves the receiver’s current configuration to the specified memory location. The number of locations varies with each type of receiver. It is important to note that the volatility of the memory is also dependant on the type of receiver. Some receivers may clear all saved settings if the “Reset Rx” button is pressed, others may maintain the memory until the receiver is powered down.

Note: Different receivers store different attributes and hence there is no uniform list of options which are saved for all receivers, with not even the basic frequency, detection mode, AGC mode, BFO and IF Bandwidth parameters saved for all receivers.

- Receiver Pass thru Command  
An ACSII-based text command can be sent directly to the receiver using the “Pass-thru command”. Enter the command string into the corresponding text field and press Enter or click “Send”. Please refer to the receiver operator’s manual for the valid command set for each receiver. If the “Response” box is checked, then an ASCII response is







expected from the receiver and it will be delivered back to the client. If the box is checked but no response is generated by the receiver then the receiver will briefly go offline while the NRC re-synchronizes communication. If a receiver response is generated when the box is not checked, the response is simply discarded. The “Response” box should not be checked unless a response is required by the user.





Note: This interface should only be used by advance users who are familiar with the impact of issuing commands directly to the receivers.

- Receiver Reset  
The receiver reset button provides a receiver reset capability, although it is important to note that the result of a reset can be different for different receivers.  
eg. Resetting the WJ-8723 receiver resets the receiver back to a known configuration profile, while resetting the TenTec Rx331 refreshes the receiver with its most recent user programmed settings.
- Receiver Reboot  
The receiver reboot button allows a low level receiver reboot sequence to be sent to the receiver where supported. It should be used when the receiver has entered into some unknown state and is a last resort before a power-off reset is tried.  
The receiver reboot process also initiates a POST of the receiver and will take about 15secs.
- Data capture  
The bottom section of the content panel allows the user to capture audio data samples from the receiver attached to this channel. Clicking the Capture button will launch the Capture channel data dialog. While capturing, the Stop button allows the user to stop data capture.

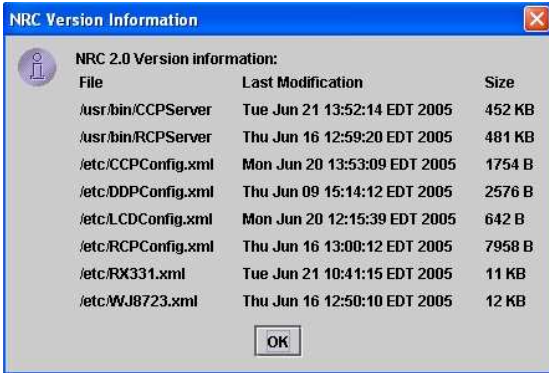
## Toolbar

The icon buttons on the top toolbar provide quick access to common functions. The below table summaries these:

	<p>“Connect to NRC server” button: when clicking this button, the “Connect to NRC server” dialog is raised, allowing the user to connect to an NRC server.</p> 
	<p>“Disconnect from NRC server” button: this button is enabled when an NRC server is selected in the tree. When clicking this button, the user can choose to disconnect from the selected NRC server.</p> 
	<p>“Reboot NRC Server” button: This button is enabled when an NRC server is selected in the tree. When clicking this button, a dialog will appear asking if you really want to reboot the NRC server. Selecting yes in this dialog will cause the NRC server to perform a warm restart. All connections to the NRC server will be terminated and new connections will need to be established with the NRC once it is fully reboot, about 60 seconds later.</p> 
	<p>“Receiver version” button: This button is enabled when the NRC server is selected in the tree. When clicking this button, a summary of the NRC software modules is displayed</p> 

	<p>“Receiver configuration” button: This button is enabled when a connected channel node is selected in the tree. When clicking this button, the configuration options of that receiver are presented. The receiver provides the actual text, so the user is referred to the receiver operating manual to decode the text.</p> 
	<p>“Receiver status” button: this button is enabled when a connected channel node is selected in the tree. When clicking this button, the status of that receiver is presented. The receiver provides the actual text, so the user is referred to the receiver operating manual to decode the text.</p> 
	<p>“Refresh” button: when clicking this button, the information on the various panels of the main application window is refreshed from the NRC server, ensuring the most up-to-date information is displayed.</p>

## Status Bar

The status bar exists at the bottom of the screen. It will contain informative messages as commands are executed.

## Change Receiver Model Dialog

The model of the receiver attached to a channel may be changed from the channel node in the tree if the client is currently connected to that channel. Right-click on the channel node, select “Change receiver model” and the “Change receiver model” dialog appears.

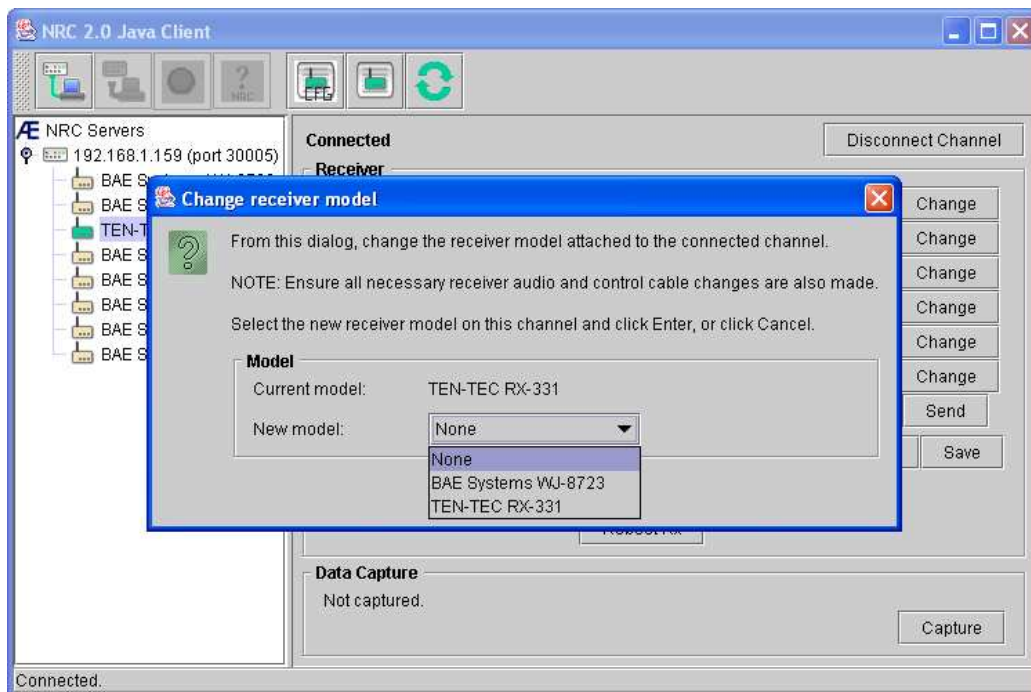

The current receiver is displayed, and a dropdown box contains a list of receiver models supported by the NRC server. Select the new model from the list or select “None” to indicate that no receiver is attached to this channel. Press Enter or click the Enter button and the dialog will be dismissed. Confirm the change by noting the contents of the tree.

The change in receiver model is persistent and will be remembered even after the NRC server is powered off.

Note: Ensure the correct receiver audio and control cables are connected to the NRC in line with these new options. Power-down the NRC while cable changes are made.



## Change Antenna Model Dialog

The name of the antenna connected to a receiver may be changed from the channel node in the tree if the client is currently connected to that channel. Right-click on the channel node, select “Change antenna”, and the “Change antenna” dialog appears.

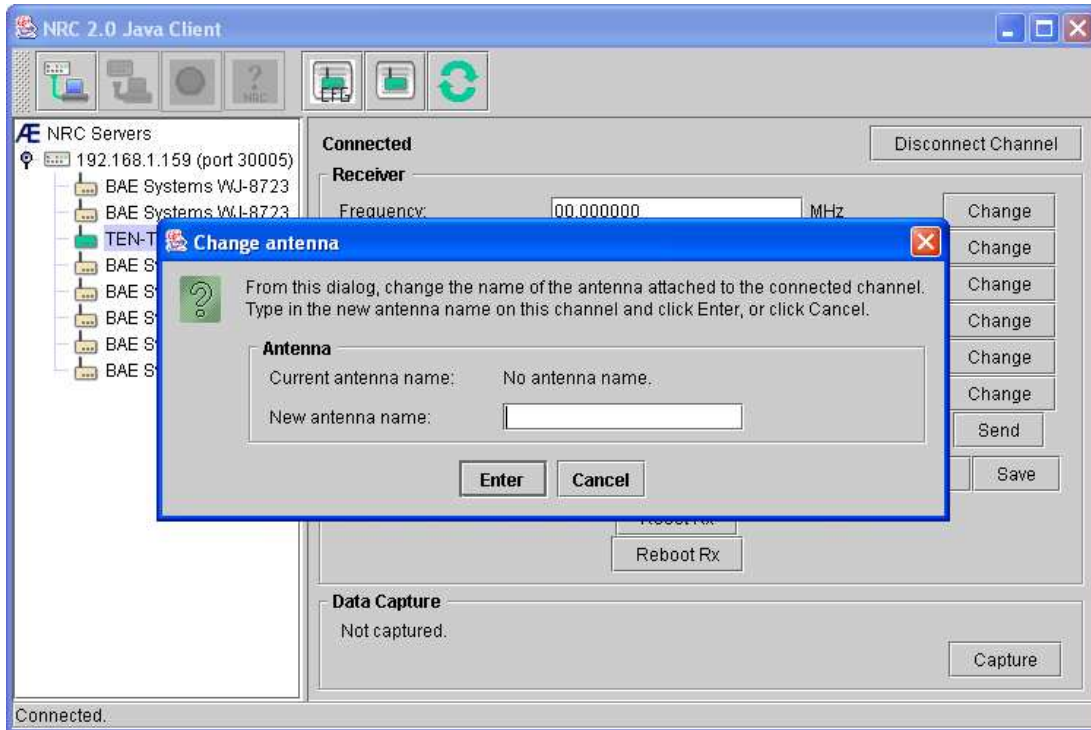

The current antenna name is displayed. Type in the new antenna name in the text box provided. Press Enter or click the Enter button and the dialog will be dismissed.

The change in antenna name is persistent and will be remembered even after the NRC server is powered off.



## NRC Properties Dialog

Global NRC properties can be viewed and modified from the respective NRC node in the tree. Right-click on the desired NRC node, select “Properties and the “NRC Properties” dialog appears.

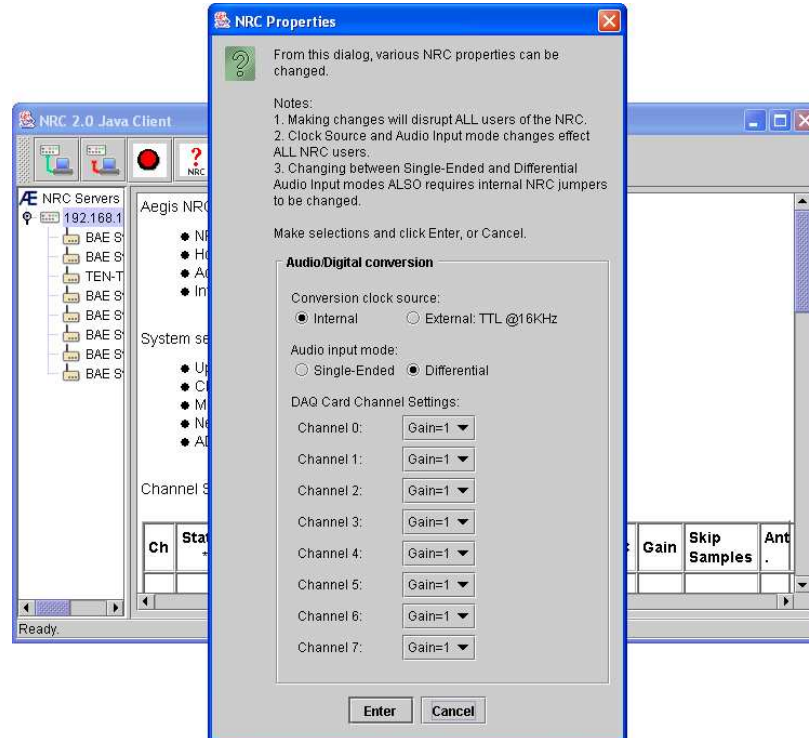

This dialog presents different NRC properties which can be changed, all of which are related to the configuration of the Audio/Digital conversion unit in the NRC:

- Conversion clock source: This selects whether the NRC internal clock triggers sampling or an external clock source triggers the sampling through the NRC’s external EXT Clock connector.
- Audio input mode: This selects whether the audio signal provided by the receivers is a single-ended or differential signal.
- DAQ Card channel Gains: This selects the pre-A/D gain which is applied to the receiver’s analog signal before it is digitized.

**Notes: If any of these settings are modified, the NRC data acquisition process is reboot, which will disrupt data capture on all channels. Use with care.** These changes are persistent and will be remembered even after the NRC server is powered off.

## Capture Channel Data Dialog

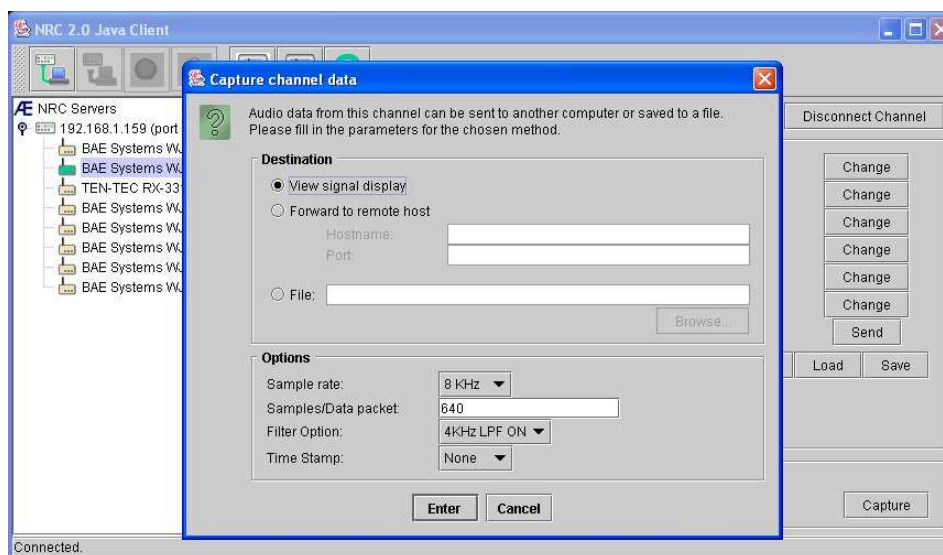

The capture dialog allows the user to start capturing digital audio samples from the channel and forward the samples to a variety of destinations.

Clicking the Capture button from the content panel launches this dialog. This button is only available if the displayed channel is connected.

### Destination

- View signal display: This option displays the Signal display dialog and uses the audio samples from this channel to drive the display. The signal can be displayed as a time based signal or a spectral signal.
- Forward to remote host: Using this option, the audio data samples are forwarded via socket to the remote host and port specified.
- File: If this option is selected, the audio samples are saved to file. Either type the full path to the file or use the Browse facility to determine the file name.

### Options

- Sample rate: Use the drop down box to specify either 8 KHz (default) or 16 KHz sample rate for the data collection.
- Samples/Data packet: Specify the number of samples the NRC server should collect before forwarding them to the client. The default is 640.
- Filter Option: If enabled, the server will filter the data through a 4KHz Low Pass Filter before sending it to the client.
- Time Stamp: If enabled, the server will time stamp<sup>5</sup> each data packet with a TAI64N time stamp representing the time that the last sample in the packet was captured. The default is for there to be no time stamp.

<sup>5</sup> If the NRC's ntp is configured the time stamp will be in synchronized with the network time, otherwise this timestamp will be synchronized to the NRC's internal system clock.

## Signal Display Dialog

This dialog represents the audio samples graphically in two possible forms. The first is signal mode, where data is graphed along the time domain.

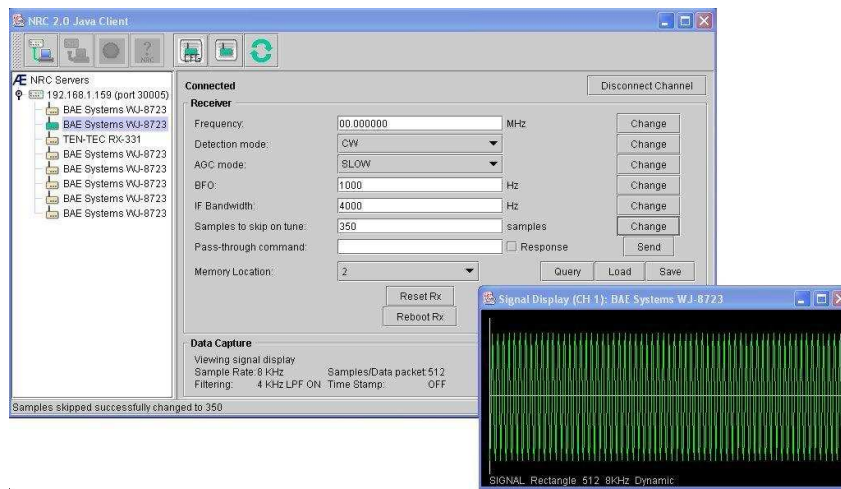

The second is a spectral mode, where the data is graphed in the frequency domain.<sup>6</sup>

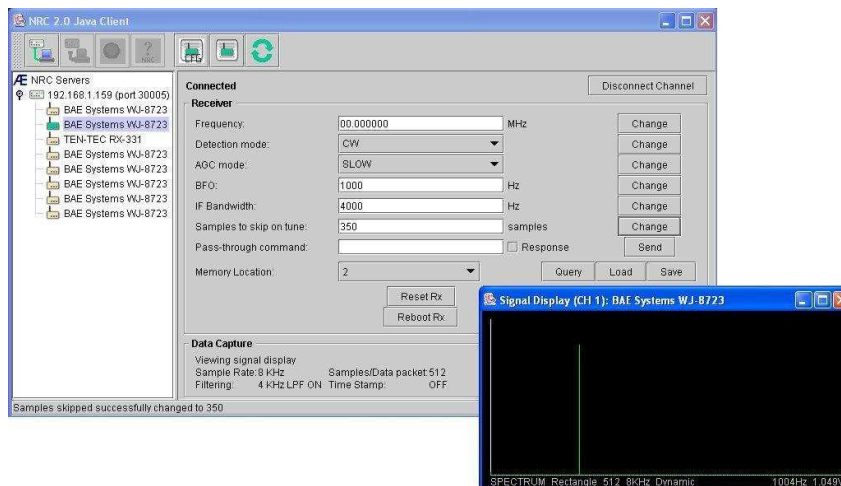

Switch between modes by right-clicking on the display and using the Display menu.

Additional information about the signal can be gleaned by moving the mouse cursor around the signal display. The cursor will turn into a crosshair design, and information regarding that point of display will be displayed at the bottom-right of the dialog. In signal mode, the time in milliseconds (x) will appear, followed by the voltage (y). In spectrum mode, the frequency in hertz (x) will be shown, followed by the voltage (y).

Closing the display dialog will stop capture on that channel.

<sup>6</sup> Meaningful Spectral displays are only displayed for data packets of sizes: 218, 256, 512, 1024, 2048 and 4096. For other data packet sizes a null display is shown.

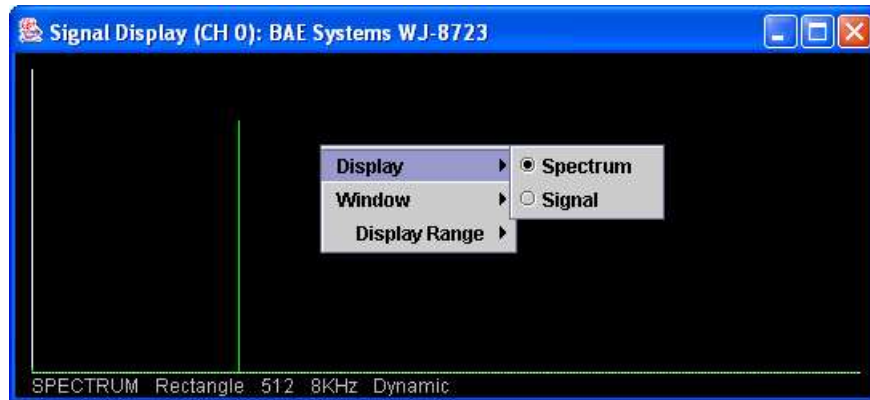

In addition to providing different graph domains, the data can be viewed using various well-known windowing functions: Rectangular, Bartlett, Hanning, Hamming, Blackman. Switch between modes by right-clicking on the display and using the Window menu.

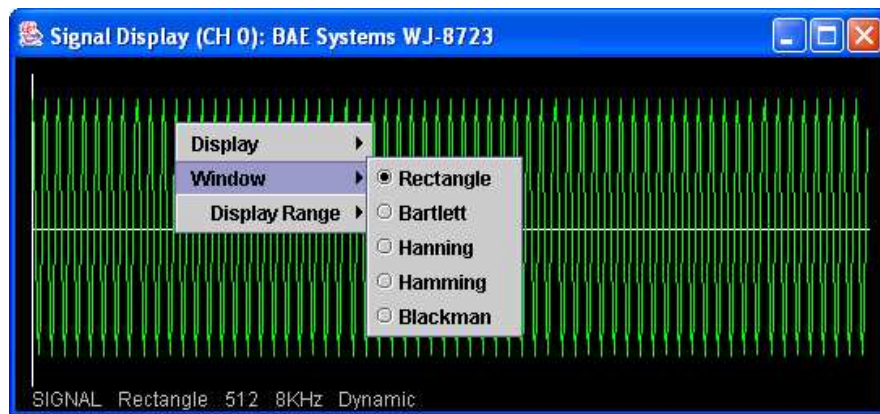

The display signals levels can be set using the Display Range menu options, which provides:

- Dynamic scaling: dynamically adjusts the signal amplitude to maximize the size of the data in the viewing window. This is the default scaling option.
- Static scaling: provides a number of different static amplitude ranges for the viewing window.

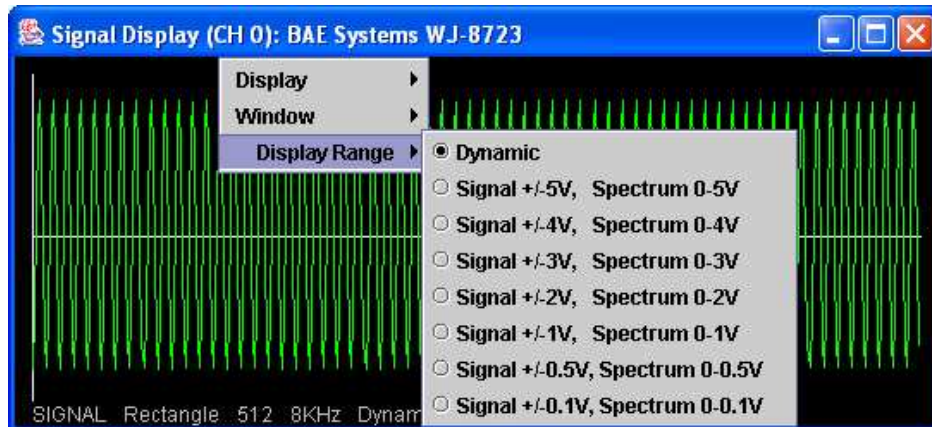

# Appendix A- Receiver Configuration

## BAE Systems WJ-8723

- The WJ-8723 must be configured to operate and communicate with the NRC units. This is achieved by configuring the WJ-8723 DIP switches A2S1 and A2S2<sup>7, 8</sup> to:
  - set the receiver mode to SINGLE-DROP mode
    - set rocker switches 1-5 of DIP switch A2S2 to 1
  - set the serial communications to 19,200 bps
    - set rocker switches 1-3 of DIP switch A2S1 to 1,0,0 respectively
- Once the receiver switch settings have been adjusted, cycle the receiver power for switch settings to become active.
- Be sure to use the BAE Systems WJ-8723 correct control and audio cables.<sup>9</sup>
- Connect the control cable from the RS-232/CTL port (D25F) on the receiver to one of the NRC's COM ports (RJ-45F). The number of this NRC COM port determines the channel number of that receiver.
- Connect the audio cable from the AUDIO OUT/AUX port on the receiver to the corresponding RCVR port on the NRC. Be sure to select the RCVR port with the same number as the COM port chosen in the previous step.

## TEN-TEC RX-331

- The RX-331 must be configured to operate and communicate with the NRC units. This is achieved by configuring the RX-331 DIP switches S1 and S2<sup>10, 8</sup> to:
  - set the receiver address to 1
    - set rocker switches 1-8 of DIP switch S2 to 0,0,0,0,0,0,1 respectively
  - set the serial communications to 19,200 bps, , 8 data bits, no parity, and 1 stop bit.
    - set rocker switches 1-8 of DIP switch S1 to 0,1,1,1,1,0,0,0 respectively.
- Once the receiver switch settings have been adjusted, cycle the receiver power for switch settings to become active.
- Be sure to use the correct control and audio cables for the TEN-TEC RX-331.<sup>11, 12</sup>
- Connect the D25M end of the combined NULL modem/control cable to the RS232, J1 port (D25F) on the receiver and the other end to one of the NRC's COM ports (RJ-45F). The number of this NRC COM port determines the channel number of that receiver.
- Connect the audio cable from the J8 port on the receiver to the corresponding RCVR port on the NRC. Be sure to select the RCVR port with the same number as the COM port chosen in the previous step.

---

<sup>7</sup> Full Instructions on page 2-9 of the "Installation and Operation Manual for the WJ-8723 Digital HF Receiver" Manual

<sup>8</sup> Switch settings: 1 is UP/ON, 0 is DOWN/OFF.

<sup>9</sup> These cables can be obtained from Aegis Inc.

<sup>10</sup> Refer to page 4-12 of the "HF DSP Receiver Model RX-331 - Technical Manual" for full instructions

<sup>11</sup> These cables can be obtained from Aegis Inc.

<sup>12</sup> To convert between TEN-TEC RX-331 and WJ-8723 control cables requires a standard RS-232 crossover to be used in conjunction with the DB25-RJ45 cable

# Appendix B - Software Upgrades

From time to time Aegis may release an upgrade the NRC system software. This can be integrated into the NRC by either replacing the NRC systems' internal compact flash card or by remotely downloading new files into the NRC system. This appendix discusses the second option of downloading remotely new files into the NRC.

This information is provided for reference and is not expected to be needed by every user.

**NOTE: Any NRC system upgrades need to be performed by a linux/unix IT system administrator and coordinated with Aegis to ensure a smooth system upgrade - this is not a novice activity.**

## NRC File System

The NRC is built upon a Gentoo Linux file system, which includes a script file which runs during the reboot process. This script file looks to see if there are any system, upgrade files which have been placed in certain directories since the last reboot.

The file relevant portion of the system file tree is: `/root/code_changes/` directory and its sub-directories.

An extract of the relevant NRC directory structure is shown below:



where:

- `code_changes` is a command file directory
- `updates` is the directory where new system files are copied to for subsequent installation into the NRC system
- `updates/lcd` is the directory where new lcd files are placed for installation into the LCD Display
- `old` is the directory where original system files are moved to as a result of a software update
- `old/lcd` is the directory where original lcd files are moved to as a result of a software update

The NRC supports 3 null-sized command files which when placed in the `code_change` directory initiate action; UPDATE, RESTORE and CLEAN. A command file is simply a regular file of no content that has a specific file name.

## UPDATE Command

If the UPDATE command file is present in *code\_changes* directory during an NRC system bootup, a check will be made to see if there are valid NRC system files in *update* (CCPServer, RCPserver, CCPConfig.xml, RCPconfig.xml, DDPCConfig.xml, LCDConfig.xml, Receivers.xml, WJ8723.xml and/or RX331.xml) and/or any “.bmp” files in the *update/lcd* directory which need to be integrated into the NRC file system.

If valid system files are found in *update* at boot-up, the current existing NRC system files of the same name are moved into the *code\_changes/old* directory and the new system files are moved into the appropriate NRC system directories.

If valid “.bmp” files (LCD image files) are found in *update/lcd*, the current NRC directory of lcd files are copied from the NRC system into the *old/lcd* directory, and the lcd files in *update/lcd* are moved into the NRC system lcd directory.

Once this process is completed the UPDATE command file in *code\_changes* will be replaced with an UPDATE\_COMPLETE command file.

As the NRC system boots up these new files will now be part of the operational system.

## RESTORE Command

The RESTORE command allows the NRC system to be rolled back to the original configuration in the advent that recently installed UPDATE changes need to be replaced.

If the RESTORE command file is present in *code\_changes* directory during an NRC system bootup, a check will be made to see if there are valid NRC system files in *old* (CCPServer, RCPserver, CCPConfig.xml, RCPconfig.xml, DDPCConfig.xml, LCDConfig.xml<sup>13</sup>, Receivers.xml, WJ8723.xml and/or RX331.xml) and/or any “.bmp” files in the *old/lcd* directory which need to be re-integrated back into the NRC file system.

If valid system files are found in *old*, the current existing NRC system files of the same name are moved into the *code\_changes/update* directory and the old system files are moved into the appropriate NRC system directories.

If valid “.bmp” files are found in *old/lcd*, the current NRC directory of lcd files are copied from the NRC system into the *update/lcd* directory, and the lcd files in *old/lcd* are moved into the NRC system *lcd* directory.

Once this process is completed the RESTORE command file in *code\_changes* will be replaced with an RESTORE\_COMPLETE command file.

As the NRC system boots up these restored files will now be part of the operational system.

---

<sup>13</sup> For the lcd “.bmp” files to be reloaded into the display, the corresponding LCDConfig.xml in *old* needs to be edited to set the all the time fields to “0”.



## CLEAN Command

The CLEAN command removes all command, command acknowledgement files and system files from *code\_changes* directory tree.

If the CLEAN command file is present in *code\_changes* directory during an NRC system bootup, all the files in the *code\_changes* directory tree will be deleted and hence cleaned.

Once this process is completed the CLEAN command file in *code\_changes* is simply deleted – there is no acknowledgement file generated for this activity.

## Upgrade Procedure

To perform a software upgrade, the necessary files need to be downloaded into the NRC system itself. The following describes how to transfer update files and command files to the NRC.

### Part 1 – Set up the NRC system to accept incoming files

The NRC file system is set as “read-only”, which doesn’t allow files to be written to the file system. In order to change this, an *ssh* shell session needs to be established with the NRC, through which the NRC configuration utility can be run.

Step 1: Open up a new console session on the unix workstation.

Step 2: From this console session open up an *ssh* terminal session into the NRC system  
#. *ssh* root@<NRC ip address>  
#. password <enter NRC root password>

Step 3: Once the NRC Configuration Utility appears, "ctrl-c" out of this application and leave this session open.

### Part 2 - Download the new NRC system files

Step 1: Open up a new console session on the unix workstation

Step 2: From this console session use *scp* to download the necessary NRC system files into *code\_changes/updates* and new display files into *code\_changes/updates/lcd*  
eg. to download a new CCPServer  
# *scp* CCPServer root@<NRC ip address>:/root/code\_changes/updates  
# password <enter NRC root password>  
- an acknowledgement of 100% complete will be echoed back to the terminal window for each file transferred.

Step 3: Repeat Step 2 as many time as is needed to download all necessary files. Note that *scp* supports wildcarding, so multiple files can be downloaded in one command.



eg. to copy all bmp display files into the appropriate NRC directory:  
# scp \*.bmp root@<NRC ip address>:/root/code\_changes/updates/lcd  
# password <enter NRC root password>  
- an acknowledgement of 100% complete will be echoed back to the terminal window for each file transferred.

### Part 3 - Download the Command files

Step 1: In the console session on the unix workstation create an empty command file (either UPDATE, RESTORE or CLEAN)  
eg. # touch UPDATE

Step 2: Download the command file  
eg. # scp UPDATE root@<NRC ip address>:/root/code\_changes  
# password <enter NRC root password>  
- an acknowledgement of 100% complete will be echoed back to the terminal window for the transferred command file.

Step 3: Optional – Check file transfer  
From the open ssh session view that the files have been transferred by navigating to the appropriate directory and listing the contents of that directory  
eg. Navigate to */root/code\_changes* to view file

### Part 3 - Alternative - Create the command file directly on the NRC

Step 1: From the *ssh* shell navigate on the NRC */root/code\_changes*

Step 2: Use touch to create an empty command file directly in the */root/code\_changes* directory.  
eg. touch UPDATE

### Part 4 - Initiate Command Action

The NRC needs to be re-booted for the changes to take effect.

Step 1: Reboot the NRC system by typing *reboot* in the NRC's ssh terminal session or cycle the NRC power.

Step 2: During up the reboot process the */root/code\_changes* directory will be read and if one of the three command files is found the necessary action will be initiated.

Step 3: Once the changes have taken place, the command file will be replaced by the corresponding command acknowledgement file. This can be optionally viewed via an *ssh* session.

