

SONY

Portable MiniDisc Recorder

Operating Instructions

Recorder Operation _____ **page 11**

Software Operation _____ **page 92**



Net MD



MDLP

"WALKMAN" is a registered trademark of Sony Corporation to represent Headphone Stereo products.  is a trademark of Sony Corporation.

MZ-N910

©2003 Sony Corporation

WARNING

To prevent fire or shock hazard, do not expose the unit to rain or moisture.

Do not install the appliance in a confined space, such as a bookcase or built-in cabinet.

To prevent fire, do not cover the ventilation of the apparatus with news papers, table cloths, curtains, etc. And don't place lighted candles on the apparatus.

To prevent fire or shock hazard, do not place objects filled with liquids, such as vases, on the apparatus.

Certain countries may regulate disposal of the battery used to power this product. Please consult with your local authority.

Caution

The use of optical instruments with this product will increase eye hazard.

CAUTION — INVISIBLE LASER RADIATION WHEN OPEN

AVOID EXPOSURE TO BEAM

Information

IN NO EVENT SHALL SELLER BE LIABLE FOR ANY DIRECT, INCIDENTAL OR CONSEQUENTIAL DAMAGES OF ANY NATURE, OR LOSSES OR EXPENSES RESULTING FROM ANY DEFECTIVE PRODUCT OR THE USE OF ANY PRODUCT.

The validity of the CE marking is restricted to only those countries where it is legally enforced, mainly in the countries EEA (European Economic Area).

- SonicStage, OpenMG and the OpenMG logo, MagicGate Memory Stick and the MagicGate Memory Stick logo, Memory Stick and the Memory Stick logo, Net MD and the Net MD logo are trademarks of Sony Corporation.
- Microsoft, Windows, Windows NT and Windows Media are trademarks or registered trademarks of Microsoft Corporation in the United States and /or other countries.
- IBM and PC/AT are registered trademarks of International Business Machines Corporation.
- Macintosh is a trademark of Apple Computer, Inc. in the United States and/or other countries.
- MMX and Pentium are trademarks or registered trademarks of Intel Corporation.
- All other trademarks and registered trademarks are trademarks or registered trademarks of their respective holders.
- TM and ® marks are omitted in this manual.

Notice for users

On the supplied software

- Copyright laws prohibit reproducing the software or the manual accompanying it in whole or in part, or renting the software without the permission of the copyright holder.
- In no event will SONY be liable for any financial damage, or loss of profits, including claims made by third parties, arising out of the use of the software supplied with this recorder.
- In the event a problem occurs with this software as a result of defective manufacturing, SONY will replace it. However, SONY bears no other responsibility.
- The software provided with this recorder cannot be used with equipment other than that which is so designated.
- Please note that, due to continued efforts to improve quality, the software specifications may be changed without notice.
- Operation of this recorder with software other than that provided is not covered by the warranty.

Program © 2001, 2002 Sony Corporation

Documentation © 2003 Sony Corporation

Table of contents

Recorder Operation

Looking at controls	12
---------------------------	----

Getting started	16
-----------------------	----

Recording an MD right away!	19
-----------------------------------	----

Playing an MD right away!	23
---------------------------------	----

Various ways of recording	25
Viewing various information	25
To start/stop recording in sync with the sound source (Synchro-recording)	26
Long-time recording (MDLP)	27
Recording from a TV or radio (Analog Recording)	28
Recording from a microphone	29
To select microphone sensitivity	29
Adding track marks while recording	30
Adding track marks manually	30
Adding track marks automatically (Auto Time Mark)	30
Adjusting the recording level manually	31

Various ways of playback	32
Viewing various information	32
Selecting the play mode	32
Playing a track repeatedly (Repeat Play)	33
Listening to selected tracks only (Bookmark Play)	33
Listening to tracks in a desired sequence (Program Play)	34
Adjusting the sound (Virtual-Surround • 6-Band Equalizer)	34
Varying the virtual sound to create different acoustics (Virtual-Surround)	34
Selecting the sound quality (6-Band Equalizer)	35
Changing playback speed (Digital Pitch Control)	36
Setting the alarm (Melody Timer)	36
Connecting to a stereo system (LINE OUT)	38

Editing recorded tracks	39
Before editing	39
Labeling a track or a disc (Name)	39
Labeling	40
Re-labeling	41
Moving recorded tracks (Move)	42
Dividing a track (Divide)	43
Dividing a track directly	43
Adjusting the dividing point before dividing a track (Divide Rehearsal)	43
Combining tracks (Combine)	44
Erasing tracks and the entire disc (Erase)	44
To erase a track	45
To erase the whole disc	45

Using the group function	46
What is the group function?	46
Using the group function when recording	46
Recording tracks to a new group	46
Recording a track to an existing group	47
Using the group function when playing	47
Playing a track in group play	47
Selecting the play mode for group play (Group Play Mode)	48
Repeat play for the selected group play mode (Group Repeat Play)	48
Playing groups in a desired sequence (Group Program Play)	48
Editing groups	49
Assigning tracks or groups as a new group (Group Setting)	49
Releasing a group setting	50
Labeling recorded groups	50
Moving a track in a disc with group setting	51
Changing the order of a group on a disc (Group Move)	52
To erase a group	52

Other operations	54
Useful settings	54
How to use the menu items	57
Setting the clock to stamp the recorded time	58
Turning off the beep sound	58
Changing the operational direction of the display	59
Preserving battery power (Power Save Mode)	59
Recording without overwriting existing material	59
Creating a new group when recording	60
Selecting the play mode	60
Adjusting the sound (Virtual-Surround • 6-Band Equalizer)	62
Changing playback speed (Digital Pitch Control)	63
Starting the playback quickly (Quick Mode)	63
Protecting your hearing (AVLS)	64
Viewing various information	64
Turning on/off the backlight	65
Adjusting the contrast of the display window (Contrast Adjustment)	65
Labeling (Name)	65
Moving recorded tracks	66
Erasing tracks, the entire disc or groups (Erase)	67
Assigning tracks or groups as a new group (Group Setting)	67
Releasing a group setting	67
Using the alarm (Melody Timer)	68
Storing the settings for individual discs (Personal Disc Memory)	68
List of menus	70

Power sources	72
Battery life	72

Additional information	73
Precautions	73
Specifications	75

Troubleshooting and explanations	77
Troubleshooting	77
While charging	77
While recording	78
While playing	80
While Editing	82
While using group function	83
Others	83
Messages	85
Explanations	89

Software Operation

What is a Net MD?	93
-------------------------	----

Basic Operations	94
Basic operational flow using the Net MD	94
Providing the required system environment	95
System requirements	95
Installing the software onto your computer	96
Before installing the software	96
Installing SonicStage Ver.1.5	97
Connecting the Net MD to your computer	99
Storing audio data to your computer	100
Starting SonicStage	100
Recording audio CDs to the hard disk drive	101
Labeling audio data	103
Transferring audio data from your computer to the Net MD (Check-out)	104
Checking out audio files to the Net MD	104
Listening to an MD	107
Listening to an MD with the Net MD connected to the computer	107
Listening to an MD with the Net MD disconnected from the computer	107

Advanced operations	108
Using other functions!	108
Using the SonicStage online help	108

Other information	110
Settings and Precautions	110
Settings according to OS	110
For users with OpenMG Jukebox, SonicStage, or SonicStage Premium installed on their computer	112
Note on hard disk drive space	113
Notes on system suspend/hibernation mode	113
Backing up the audio data	113
Uninstalling the SonicStage software	114
For Windows XP users	114
For Windows Millennium Edition/Windows 98 Second Edition users	114
For Windows 2000 users	115
Troubleshooting	116
If your computer does not recognize the Net MD	118
If the installation was not successful	118
Information and explanations	120
Net MD FAQ	120
On copyright protection	122
Glossary	124
Index	126

Before using this product

This manual explains the recorder operations and the installation and basic use of the supplied SonicStage software. For details on the various operations, refer to the pages indicated below.

When using the recorder

Recorder Operation (pages 11 to 91)

Pages 11 to 91 in this manual explain the use of the Net MD as an ordinary MiniDisc Walkman.

Troubleshooting and explanations (page 77)

This section shows the troubles you may find while using the recorder, and their solutions.



When using the Net MD (the recorder) connected to your computer

Software Operation (pages 92 to 125)

Pages 92 to 125 in this manual explain the installation and basic operations of the supplied SonicStage software. Refer to these pages for details.

Other information (page 110)

This section shows the troubles you may find while using the SonicStage software, and their solutions. It also has the list of frequently asked questions and answers.

SonicStage Ver. 1.5 Help

This is an online help that you can view on your computer screen.

Refer to online help for details on the use of the software. To display the help window, see page 108.

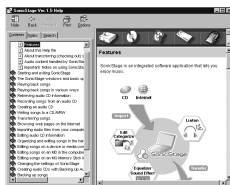

Notes on the "Software Operation" section

- The displayed items in the illustrations that appear in this section may differ from the actual items displayed by the software.
- Explanations in this section assume familiarity with basic Windows operations. For details on the use of your computer and the operating system, please refer to the respective manuals.
- Explanations in this section cover general Net MD products. For this reason, some explanations (and some illustrations) may not be applicable to your Net MD. Please refer to the operating instructions of your Net MD as well.

Checking the supplied accessories

AC power adaptor (1)

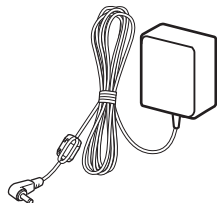

Battery charging stand (1)

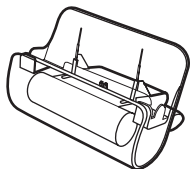

Headphones/earphones with a remote control (1)

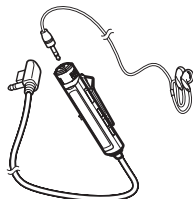

Dedicated USB cable (1)

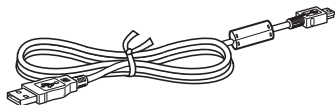

NH-14WM Nickel metal hydride rechargeable battery (1)

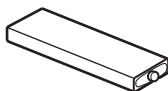

Battery carrying case (1)

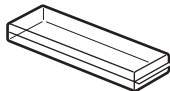

Dry battery case (1)

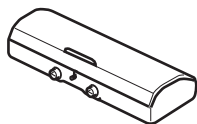

Optical cable (1)

CD-ROM (SonicStage Ver. 1.5) (1)*

Carrying pouch/carrying case with a belt clip (1)

* Do not play a CD-ROM on an audio CD player.

Looking at controls

The recorder

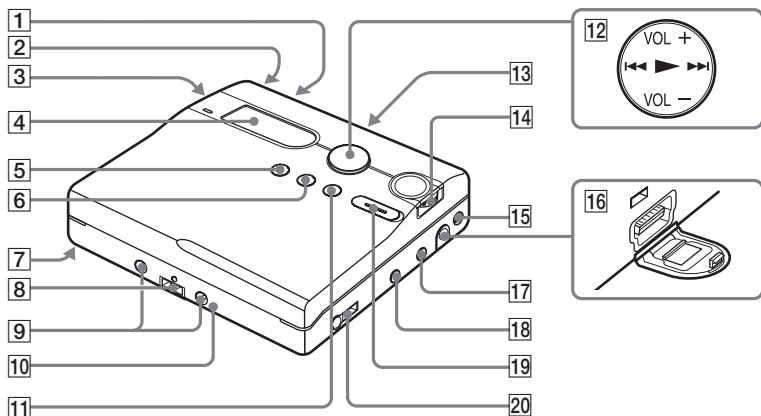

1 END SEARCH button

2 T MARK button

3 Battery compartment

4 Display window

5 GROUP button

6 ■ • CHG button

7 HOLD switch

Slide the switch in the direction of the arrow to disable the buttons on the recorder. To prevent the buttons from being accidentally operated when you carry the recorder, use this function.

8 Terminals for attaching a battery charging stand

9 Terminals for attaching a dry battery case

10 DC IN 3V jack

11 || button

12 5-way control key

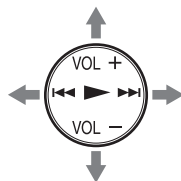

Operation	Function
Press ►*	play
Press ◀◀	rewind
Press ▶▶	fast forward
Press VOL +*, -	volume

* The ► and VOL + button has a tactile dot.

13 OPEN switch

- 14 Jog dial (MENU/ENTER)



Turn to select

Push to enter

- 15 Handstrap hole

Use the hole to attach your own strap.

- 16 Dedicated USB cable connecting jack

- 17 LINE IN (OPT) jack

- 18 MIC (PLUG IN POWER) jack

There is a tactile dot beside the MIC (PLUG IN POWER) jack.

- 19 REC (record) switch

- 20  (headphones/earphones)/LINE OUT jack

The display window of the recorder

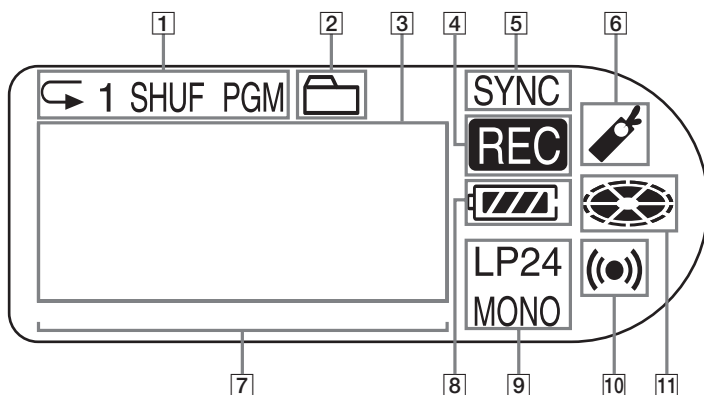

- 1 Play mode indication

Shows the play mode (shuffle play, program play, repeat play, etc.) of the MD.

- 2 Group indication

- 3 Character information display

Displays the disc and track names, date, error messages, track numbers, etc.

- 4 REC indication

Lights up while recording. When flashing, the recorder is in record standby mode.

- 5 SYNC (synchro-recording) indication

- 6 Bookmark indication

Lights up when playing a bookmarked track.

- 7 Level meter

- 8 Battery indication

Shows the approximate remaining battery condition.

- 9 LP2, LP4, MONO (monaural) indication

- 10 Melody timer indication

- 11 Disc indication

Shows that the disc is rotating for recording or playing.

The headphones/earphones with a remote control

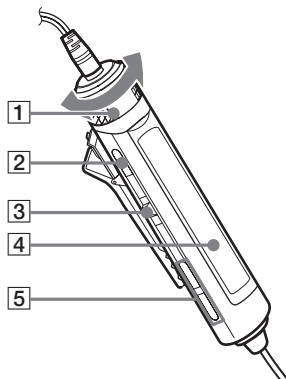

- 1** Volume control (VOL+, -)
Turn to adjust the volume.
- 2** ■ (stop) button
- 3** Jog lever (▶||/ENT, ◀◀, ▶▶)
▶||/ENT (to press): play, pause, enter
◀◀ (to slide towards): REW
▶▶ (to slide towards): FF
- 4** Display window
- 5** 📁 (group) +, -

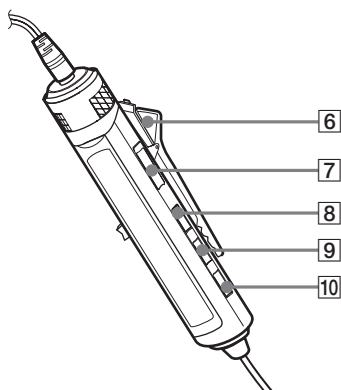

- 6** Clip
- 7** HOLD switch
Slide the switch in the direction of the arrow (a yellow mark appears) to disable the buttons on the remote control. To prevent the buttons from being accidentally operated when you carry the recorder, use this function.
- 8** DISPLAY button
- 9** P MODE/⏪ button
- 10** SOUND button

Using the clip for the remote control

It may be hard for you to read the indications in the display if the remote control is attached upside down with the clip in its current position. In this case, attach the clip in the opposite direction as shown below.

1 Remove the clip.

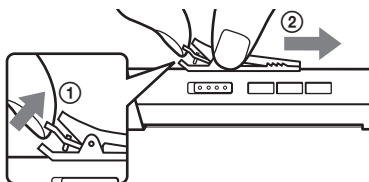

2 Attach the clip in the opposite direction.

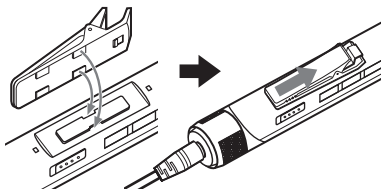

The display window of the remote control

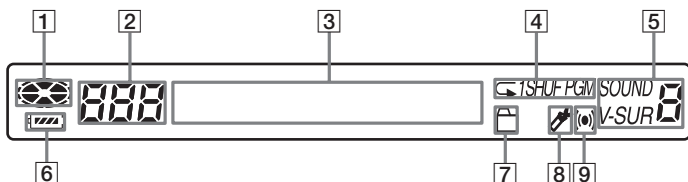

- | | |
|---------------------------------|----------------------------|
| 1 Disc indication | 6 Battery level indication |
| 2 Track number display | 7 Group indication |
| 3 Character information display | 8 Bookmark indication |
| 4 Play mode indication | 9 Melody timer indication |
| 5 SOUND indication | |

Getting started

Charge the rechargeable battery before using. Even if the rechargeable battery is not charged, you can use the recorder as long as the AC power adaptor is connected.

1 Insert the rechargeable battery.

Slide OPEN to open the battery compartment lid.

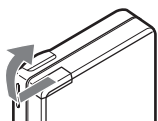

Insert the NH-14WM rechargeable battery minus end first.

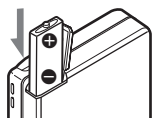

Close the lid.

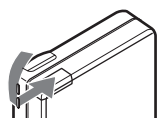

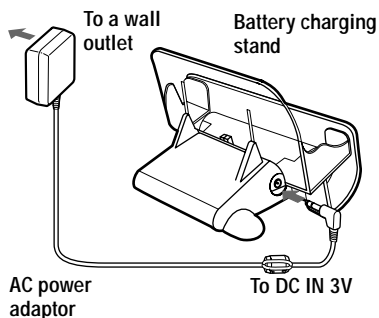

2 Charge the rechargeable battery.

- 1 Connect the AC power adaptor to the battery charging stand and the AC adaptor to a wall outlet.

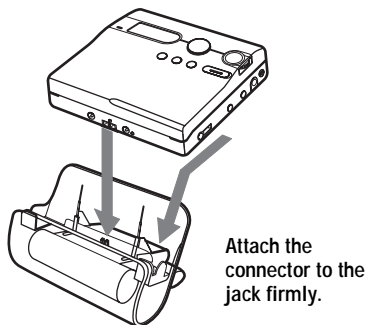

- 2 Place the recorder on the battery charging stand.



“Charging” flashes,  appears in the display, and charging starts. When charging is completed, the battery indication disappears. Full charging of a completely discharged rechargeable battery takes about 3.5 hours. The recorder can be used when  disappears in the display. The battery will be fully charged after charging is continued 2 more hours.

- Remove the recorder from the battery charging stand.

For models supplied with the AC plug adaptor

If the AC power adaptor does not fit the wall outlet, use the AC plug adaptor.

Using the alkaline dry battery

Attach the dry battery case to the recorder.

Insert the battery minus end first.

Rear of the recorder

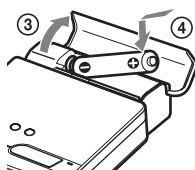
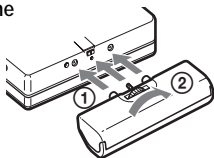

Insert a LR6 (size AA) alkaline dry battery.

To operate the recorder for the longest possible time, use the dry battery together with a fully charged rechargeable battery.

3 Make connections and unlock the controls.

- Connect the headphones/earphones with the remote control to \odot /LINE OUT.
- Slide HOLD to the opposite direction of the arrow (\rightarrow) on the recorder or the remote control to unlock the controls.

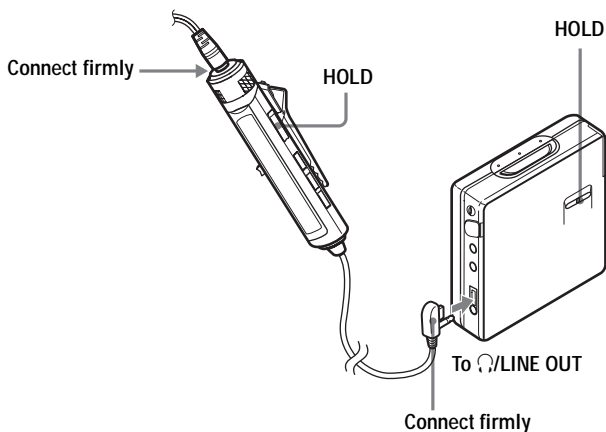



continued



You can also charge the rechargeable battery by connecting the AC power adaptor directly to the recorder.

Connect the AC power adaptor to DC IN 3V on the recorder, and then press **■** • CHG while the recorder is stopped.

“Charging” and  appear in the display and charging starts. Full charging takes about 3.5 hours. Charging is complete when  disappears. Charging time may vary depending on the battery condition.

Notes

- If you start playback or do another operation during charging, the charging will stop.
- “Charging” and  may not appear in the display immediately after you place the recorder on the battery charging stand. The indication will, however, begin flashing after a few minutes and charging will begin.
- Charge the battery at a temperature of +5°C (+41°F) to +40°C (+104°F).

Battery life

The battery life is measured with the power save mode on (see “Preserving battery power (Power Save Mode)” (page 59)). For details, refer to “Battery life” (page 72).

When recording

(Unit: Approx. hours)

Batteries	SP Stereo	LP2 Stereo	LP4 Stereo
NH-14WM nickel metal hydride rechargeable battery	11	16	20
LR6 (SG) Sony alkaline dry battery	11	16	21
NH-14WM nickel metal hydride rechargeable battery + LR6 (SG)	29	38	50

When playing

Batteries	SP Stereo	LP2 Stereo	LP4 Stereo
NH-14WM nickel metal hydride rechargeable battery	31	38	45
LR6 (SG) Sony alkaline dry battery	47	57	69
NH-14WM nickel metal hydride rechargeable batter + LR6 (SG)	80	95	114

Recording an MD right away!

This section explains the basic procedure for making digital recordings using an optical cable connected to a CD player, Digital TV or other digital equipment. Make sure to use the optical cable. It is recommended to use the recorder with the AC power adaptor when recording. For other recording operations, see “Various ways of recording” (page 25).

1 Insert an MD.

1 Slide OPEN to open the lid.

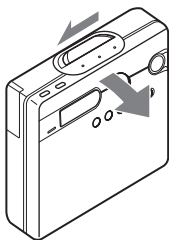

2 Insert an MD to the direction of the arrow with the label side facing front, and press the lid down to close.

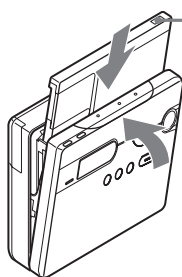

Make sure to check the record-protect tab is closed.

2 Make connections. (Insert the cables firmly and completely into the appropriate jacks.)

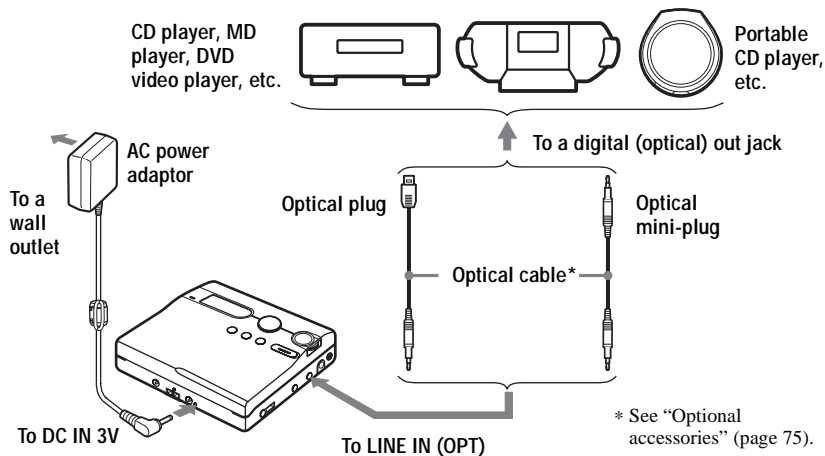

Note

It is recommended that you connect the AC power adaptor directly to the recorder while recording. If you record using the battery charging stand, make sure that the fully charged rechargeable battery is inserted in the recorder just in case the recorder becomes detached from the battery charging stand.

3 Record an MD.

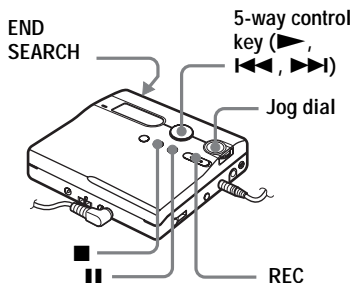

- 1 Select and pause the sound source to be recorded.
- 2 While the recorder is stopped, press and slide REC. "REC" and the REC LED light up and recording starts.
- 3 Play the source you want to record. Track marks are automatically added at the same point as the sound source.

To stop recording, press ■.

Note

If you record on a previously recorded disc, the recorder is factory set to overwrite the entire contents of the disc. If you want the recording to start after the existing contents, do the procedure "Recording without overwriting existing material" (page 59) before doing step 3, "Record an MD." (page 20).

To	Press
Record from the end of the current contents ¹⁾	Press END SEARCH, and then press and slide REC. ¹⁾
Record over previous material from a point partway through ¹⁾	Press ►, or press ◀◀, or ▶▶ to find the start point of recording, and then press ■ to stop. Then press and slide REC.
Pause	Press ■. ²⁾ Press ■ again to resume recording.
Remove the MD	Press ■ and open the lid. ³⁾ (The lid does not open while "TOC Edit" flashing in the display.)

¹⁾ If "REC-Posi" is set to "From End", recording operations will always start from the end of the previously recorded material without pressing the END SEARCH button (page 59).

²⁾ A track mark is added at the point where you press ■ again to resume recording while pausing; thus the remainder of the track will be counted as a new track.

³⁾ If you open the lid while "REC-Posi" is set to "From Here", recording will begin from the top of the disc the next time you record. Check the point to start recording on the display.

If the recording does not start

- Make sure the recorder is not locked (pages 12, 17).
- Make sure the MD is not record-protected (pages 19, 74).
- Premastered MDs cannot be recorded over.

To know the recording condition

The REC LED lights up or flashes according to the recording condition.

Recording condition	REC LED
While recording	lights up flashes according to the loudness of the source while recording with a microphone (voice mirror)
Recording standby	flashes
Less than 3 minutes' recording time available	flashes slowly
A track mark has been added ¹⁾	goes off momentarily
While checking-out	flashes faster

¹⁾ Except when track marking was done manually or automatically using Auto Time Mark (page 30).

Notes

- Do not change the rechargeable battery during operation even if the recorder is connected to the AC power adaptor. The operation may stop.
 - “TOC Edit” flashes while data of the recording (the track’s start and end points, etc.) is being recorded. Do not move or jog the recorder or disconnect the power source while the indication is flashing in the display.
 - If the power supply is disrupted (i.e. the battery is removed or becomes exhausted or the AC power adaptor is disconnected) during a recording or editing operation, or while “TOC Edit” appears in the display, then it will not be possible to open the lid until power is restored.
 - Note the following when recording from a portable CD player:
 - Some portable CD players may not be capable of digital out when the AC power adaptor is disconnected. If this is the case, connect the AC power adaptor to the portable CD player and use it on AC power as the power source.
 - On some portable CD players, optical output may not be possible when using an anti-skip function (e.g., ESP* or G-PROTECTION). If this is the case, turn off the anti-skip function.
- * Electronic Shock Protection



- The recording level is adjusted automatically. To adjust the level manually, see “Adjusting the recording level manually” (page 31).
- You can monitor the sound during recording. Connect the headphones/earphones with remote control to /LINE OUT and adjust the volume by turning the control on the remote control (pressing VOL + or – on the recorder). This does not affect the recording level.

Playing an MD right away!

1 Insert an MD.

- 1 Press OPEN to open the lid.

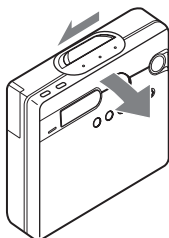

- 2 Insert an MD to the direction of the arrow with the label side facing front, and press the lid down to close.

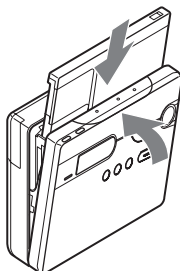

2 Play an MD.

5-way control key (▶, ◀◀, ▶▶, VOL+, -)

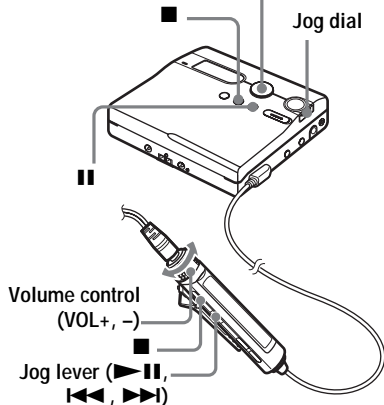

A short beep sounds in the headphones/earphones when you operate.

- 2 Press VOL + or - to adjust the volume on the recorder.
Turn the volume control towards VOL + or - on the remote control.
The volume will be shown in the display.

To stop play, press ■.

A long beep sounds in the headphones/earphones when you operate. After you stop the recorder, the recorder will automatically turn off in about 10 seconds (when using batteries) or about 3 minutes (when using an AC power adaptor).

Playback starts from the point you last stopped playing.

To start with the first track of the disc, press ▶ on the recorder or the jog lever (▶||) on the remote control for 2 seconds or more.

- 1 Press ▶ on the recorder.
Press the jog lever (▶||) on the remote control.

To	Operation on the recorder	Operation on the remote control
Pause	Press . Press again to resume play.	Press ▶▶ . Press ▶▶ again to resume play.
Select a track directly viewing track number or name	Turn the jog dial, and then press to enter.	—
Find the beginning of the current track	Press ◀◀◀ . Press ◀◀◀ repeatedly until you reach the beginning of the desired track.	Slide the jog lever towards ◀◀◀ . Slide the jog lever towards ◀◀◀ repeatedly until you reach the beginning of the desired track.
Find the beginning of the next track	Press ▶▶▶ .	Slide the jog lever towards ▶▶▶ .
Go backwards or forward while playing	Press and hold ◀◀◀ or ▶▶▶ .	Slide and hold the jog lever towards ◀◀◀ or ▶▶▶ .
Search for a point in a track while viewing the elapsed time (Time search)	While pausing, press and hold ◀◀◀ or ▶▶▶ .	While pausing, slide and hold the jog lever towards ◀◀◀ or ▶▶▶ .
Search for a specific track while viewing track numbers (Index search)	While the recorder is stopped, press and hold ◀◀◀ or ▶▶▶ .	While the recorder is stopped, slide and hold the jog lever towards ◀◀◀ or ▶▶▶ .
Cue to the beginning of every 10th track (only during playback of the disc with no group settings) ¹⁾	Press GROUP , and then press ◀◀◀ or ▶▶▶ .	Press ⏮ + or ⏭ .
Remove the MD	Press ■ and open the lid. ²⁾	Press ■ and open the lid.

¹⁾ For more details, see “Using the group function” (page 46).

²⁾ Once you open the lid, the point to start play will change to the beginning of the first track (except when the disc information is stored to the Personal Disc Memory).

If the play does not start

Make sure the recorder is not locked (pages 12, 17).

Note

The playback sound may skip if:

- the recorder receives stronger continuous shock.
- a dirty or scratched MiniDisc is played.

Viewing various information

You can check the remaining time, track number, etc. when recording or during stop. Group-related items appear only when a track with group settings is played and then stopped.

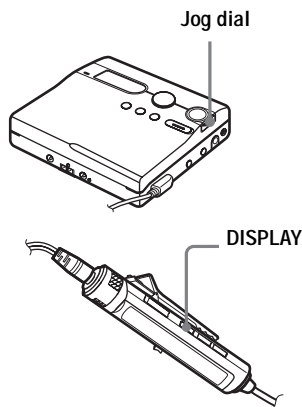

On the recorder

- 1 Press the jog dial.
- 2 Turn the jog dial until "DISPLAY" appears in the display, and then press the jog dial.
- 3 Turn the jog dial until the information you want appears in the display, and then press the jog dial to enter the selection.

Display window on the recorder

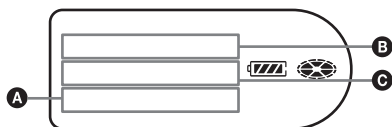

Each turn changes the display as follows.

LapTime → RecRemain → GP Remain → AllRemain → Title → Sound → Clock

When you press the jog dial, the selected information appears at **A**, **B** and **C**.

A (selected item)	B	C
— (LapTime)	Track number	Elapsed time
RecRemain	Track number	Remaining time for recording
GP Remain	Numbers of tracks after the current tracks in the group	Remaining time after the current location within the group
AllRemain	Numbers of tracks after the current track	Remaining time after the current location
Track name	Disc name	Group name
Sound mode name	Indication of the selected sound mode	—
Clock	Current date	Current time

Note

Depending on the group settings, the operating conditions, and the disc settings, you may not be able to select certain indications or the indications may appear differently.

On the remote control

1 Press DISPLAY.

Each time you press the button, the display changes as follows.

Display window on the remote control

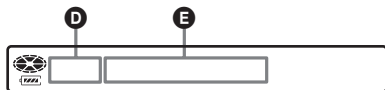

Display: D/E

D	E
Track number	Elapsed time
Track number	Track name
Numbers of tracks in the group	Group name
Numbers of tracks in the disc	Disc name
Track number	Disc name
Track number	Indication of the selected sound mode
—	Current time

Note

Depending on the group settings, the operating conditions, and the disc settings, you may not be able to select certain indications or the indications may appear differently.



If you want to check the playing position or track name while playing, see “Viewing various information” (page 32).

To start/stop recording in sync with the sound source (Synchro-recording)

During synchro-recording, the starting and stopping of recording occurs are synchronized with the sound source. This simplifies digital recordings (e.g., from a CD player) since the need to operate the recorder or the sound source is eliminated. Synchro-recording is only possible with the optical cable connected.

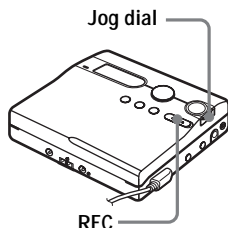

- 1** Make connections.
Use the appropriate optical cable to suit the source equipment. For details, see “Optional accessories” (page 75).
- 2** While the recorder is stopped, press the jog dial.
- 3** Turn the jog dial until “REC SET” appears in the display, and then press the jog dial.
- 4** Turn the jog dial until “SYNC REC” appears in the display, and then press the jog dial.
- 5** Turn the jog dial until “SYNC ON” appears in the display, and then press the jog dial.
- 6** Press and slide REC.
“REC” and the REC LED on the recorder light up in the display and the recorder stands by for recording.

- 7 Play the source you want to record.
The recorder starts recording automatically when it receives the playing sound.

To stop recording

Press ■.



When there is no sound from the player for about 3 seconds during synchro-recording, the recorder goes into the standby mode automatically. When the sound comes from the player again, the recorder resumes synchro-recording. If the recorder is kept in the standby mode for 5 minutes or longer, the recorder stops automatically.

Notes

- The pause function cannot be turned on or off manually during synchro-recording.
- Do not switch the “SYNC REC” setting while recording. Recording may not be done properly.
- Even when there is no sound on the sound source, there may be cases when recording does not pause automatically during synchro-recording due to the noise level emitted from the sound source.
- If a silent portion is encountered for approximately 2 seconds during synchro-recording from a sound source other than a CD or an MD, a new track mark is automatically added at the point where the silent portion ends.

Long-time recording (MDLP)

Select each recording mode according to the recording time that you want. Stereo recording is possible at 2 times (LP2) or 4 times (LP4) the normal (stereo) recording time. Monaural recording at 2 times normal recording time is also possible.

MDs recorded in MDLP mode can be played back only on MD players or recorders with MDLP playback mode.

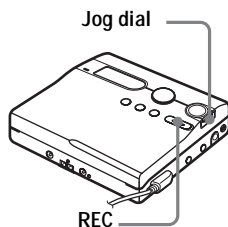

- 1 While the recorder is stopped, press the jog dial.
- 2 Turn the dial until “REC SET” appears in the display, and then press the jog dial.
- 3 Turn the dial until “REC MODE” appears in the display, and then press the jog dial.

- 4 Turn the jog dial to select the desired recording mode, and then press the jog dial to enter the selection.

Recording mode ¹⁾	Display window on the recorder	Recording time ³⁾
SP stereo	SP	Approx. 80 min.
LP2 stereo	LP2	Approx. 160 min.
LP4 stereo	LP4	Approx. 320 min.
Monaural ²⁾	MONO	Approx. 160 min.

¹⁾ For better sound quality, record in normal stereo (stereo) or LP2 stereo mode.

²⁾ If you record a stereo source in monaural, the sounds from left and right will be mixed.

³⁾ When using an 80-minute recordable MD

- 5 Press and slide REC to start recording.

- 6 Play the source you want to record.

To stop recording

Press ■.

The recorder keeps the setting of the recording mode when you record the next time.



Audio components that support the LP2 stereo or LP4 stereo modes are indicated by the **MDLP** or **MDLP** logo marks.

Notes

- It is recommended that you use the AC power adaptor for long recordings.
- When you record in LP4 mode, momentary noise may be produced on very rare occasions with certain sound sources. This is because of the special digital audio compression technology that enables a recording time 4 times longer than normal. If noise is produced, it is recommended that you record in normal stereo or LP2 mode to obtain better sound quality.

Recording from a TV or radio (Analog Recording)

This section explains how to record from an analog equipment such as a cassette recorder, radio, or TV.

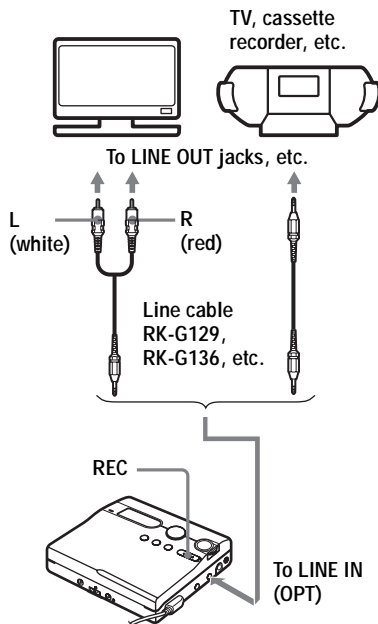

- 1 Make connections.

Use the appropriate connecting cord to suit the source equipment. For details, see “Optional accessories” (page 75).

- 2 Press and slide REC to start recording.

- 3 Play the source you want to record.

Recording from a microphone

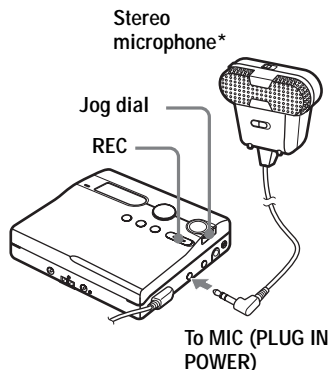

* See "Optional accessories" (page 75).

- 1 Connect the stereo microphone to the MIC (PLUG IN POWER) jack. The recorder changes to microphone input automatically.
- 2 Press and slide REC to start recording.

To select microphone sensitivity

- 1 While the recorder is recording or stopped, press the jog dial.
- 2 Turn the jog dial until "REC SET" appears in the display, and then press the jog dial.
- 3 Turn the jog dial until "MIC SENS" appears in the display, and then press the jog dial.

- 4 Turn the jog dial until "SENS HIGH" or "SENS LOW" appears in the display, and then press the jog dial to enter the selection.

SENS HIGH: When recording a soft sound or a sound with a normal volume.

SENS LOW: When recording a loud sound or a sound at close range.



When using a plug-in power-type microphone, the microphone can be operated even when its power switch is turned off since power is supplied from the recorder itself.

Notes

- The recorder automatically switches input in the following order; optical input, microphone input, and analog input. You cannot record through the microphone while an optical cable is connected to the LINE IN (OPT) jack.
- The microphone may pick up the operating sound of the recorder itself. Use the microphone away from the recorder in such cases. Please note that the sound of recorder operations may be picked up if the microphone that you use has a short connector.
- Only the left-channel sound is recorded when a monaural microphone is used.

Adding track marks while recording

You can add track marks (track number) while recording to divide the material into separate parts.

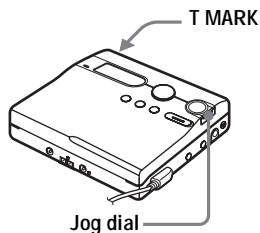

Adding track marks manually

- 1 While the recorder is recording, press T MARK (press P MODE/⏏ on the remote control).

Adding track marks automatically (Auto Time Mark)

Use this feature to add track marks automatically at specified intervals when recording through the analog input connector or a microphone. This function is convenient for recording long period of time, such as lectures, meetings, etc.

- 1 While the recorder is recording or in recording pause, press the jog dial.
- 2 Turn the jog dial until “REC SET” appears in the display, and then press the jog dial.
- 3 Turn the jog dial until “TIME MARK” appears in the display, and then press the jog dial.
“OFF” flashes in the display.

- 4 Turn the jog dial until “ON” appears in the display, and then press the jog dial.
- 5 Turn the jog dial until the desired time interval appears in the display, and then press the jog dial to enter the selection.

One rotation of the jog dial changes the time setting (Time:) by 1 minute, within the range of 1 to 99 minutes.

To cancel Auto Time Mark
Select “OFF” in step 4 or stop recording.

Using Auto Time Mark to add track marks while recording

When the elapsed recording time exceeds the time interval for Auto Time Mark:

The recorder adds track marks at the point you set the time interval and from that point the recorder adds a track mark whenever the time interval has elapsed.

Example: Eight minutes of recording has been completed when the Auto Time Mark time interval is set to 5 minutes. A track mark will be added at the 8-minute point (after the start of recording) and after each 5-minute interval thereafter.

When the time interval set for Auto Time Mark exceeds the elapsed recording time:

The recorder adds track marks when the set Auto Time Mark time interval has elapsed.

Example: Three minutes of recording has been completed when the Auto Time Mark time interval is set to 5 minutes. A track mark will be added at the 5-minute point (after the start of recording) and after each 5-minute interval thereafter.



“T” appears before the time display on the recorder for track marks added by Auto Time Mark, and “T” appears after the time display on the remote control.

Notes

- If you add a track mark by pressing T MARK or **II**, etc. while recording, Auto Time Mark will begin automatically adding track mark each time the selected time interval as elapsed.
- The setting will be lost when the recording stopped.

Adjusting the recording level manually

The sound level is adjusted automatically while recording. If necessary, you can set the recording level manually during both analog and digital recording.

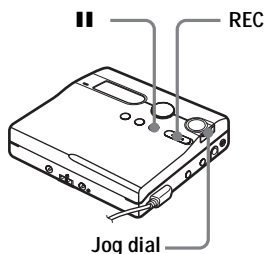

- 1 While pressing **II**, press and slide REC.
The recorder stands by for recording.
- 2 Press the jog dial.
- 3 Turn the jog dial until “REC SET” appears in the display, and then press the jog dial.
- 4 Turn the dial until “RecVolume” appears in the display, and then press the jog dial.

- 5 Turn the jog dial until “ManualREC” appears in the display, and then press the jog dial.

- 6 Play the source.

- 7 While observing the level meter in the display, adjust the recording level by turning the jog dial.

Set the level so that the meter segments light up between **A** and **B**. If the meter segments lights up to the right of **B**, reduce the input level. Each level meter shows the following.
Upper — L channel input level
Lower — R channel input level

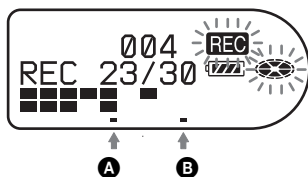

- 8 Press **II** again to start recording.
If your source is an externally connected component, play the source to the beginning of the material to be recorded, and then start recording.

To switch back to automatic level control

Select “Auto REC” in step 5.

Notes

- You cannot adjust the left and right channel levels separately.
- Once you stop recording, the recorder will revert to automatic recording level adjustment mode the next time you start a recording operation.
- To adjust the recording level manually during synchro-recording, do steps 1 to 7 of the procedure in this section with “SYNC REC” is set to “SYNC OFF”. Afterwards, set “SYNC REC” setting to “SYNC ON”, and start recording (page 26).

This section explains the operations that are done on the remote control. For details on operations done on the recorder, see the pages indicated for each operation.

Viewing various information

You can check the track name, disc name, etc. during playback. Group-related items appear only when a track with group settings is played.

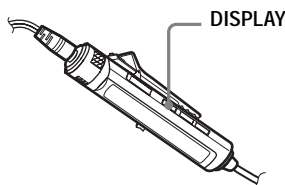

- While playing, press DISPLAY. Each time you press DISPLAY, the display changes as follows.

Display window on the remote control

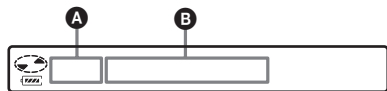

Display: A/B

A	B
Track number	Elapsed time
Track number	Track name
Numbers of tracks in the group	Group name
Numbers of tracks in the disc	Disc name
Track number	Disc name
Track number	Indication of the selected sound mode

A	B
—	Recorded time
Track number	SP/LP mode of the current track

Note

Depending on the group settings, the operating conditions, and the disc settings, you may not be able to select certain indications or the indications may appear differently.



If you want to check the remaining time or the recording position while recording or in stop mode, see "Viewing various information" (page 25).

For the recorder operation, see page 64.

Selecting the play mode

You can select the various play modes using the P MODE/⏮ button.

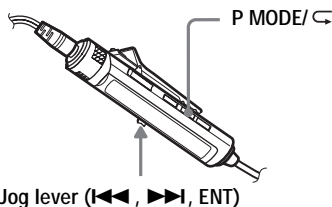

- Press P MODE/⏮ repeatedly. Each time you press the button, the play mode changes as follows:

Play mode indication

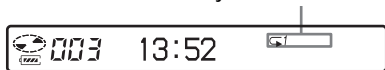



Indication ¹⁾	Play mode
(none) (normal Play)	All the tracks are played once.
1 (single-track play)	A single track is played once.
 (Bookmark play)	Bookmarked tracks play back in order of their track number.
SHUF (shuffle play)	All the tracks are played in random order.
PGM (program play)	Tracks are played in the order that you specified.

¹⁾ Group play mode () appears whenever you play a disc with group settings. For more details, see "Playing a track in group play" (page 47).

For the recorder operation, see page 60.

Playing a track repeatedly (Repeat Play)

You can use the repeat function for normal play, single-track play, shuffle play, and program play mode.

- 1 While playing in the selected play mode, press P MODE/ for 2 seconds or more.
 appears in the display.

To cancel repeat play

Press P MODE/ for 2 seconds or more.



By pressing the P MODE/ button during repeat play, you can change the play mode to used with repeat play.

For the recorder operation, see page 60.

Listening to selected tracks only (Bookmark Play)

You can bookmark tracks on a disc and play them only. The sequence of bookmarked tracks cannot be changed.

To bookmark the tracks

- 1 While playing the track you want to bookmark, press the jog lever for 2 seconds or more.

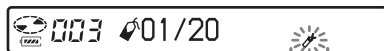



Flashing slowly

The first track of the bookmark play is set.

- 2 Repeat step 1 to bookmark the other tracks.

Bookmarks can be set up to 20 tracks in a disc.

To play the bookmarked tracks

- 1 While playing, press P MODE/ repeatedly until " TrPLAY?" appears in the display.
- 2 Press the jog lever.
The bookmarked tracks start playing, starting with the smallest track number.

To erase bookmarks

While playing the track for which you want to erase the bookmark, press the jog lever for 2 seconds or more.

Note

If you open the lid, all bookmarks are canceled.

For the recorder operation, see page 60.

Listening to tracks in a desired sequence (Program Play)

- 1 While playing, press P MODE/  repeatedly until “PGM” appears in the display.
- 2 Slide the jog lever repeatedly to select a track, and then press to enter that track.



- 3 Repeat step 2 to program more tracks. You can program up to 20 tracks.
- 4 After programming the tracks, press the jog lever for 2 seconds or more. The program is stored and playback starts from the first track.



The program play setting will remain in memory even after playback finishes or is stopped.

Note

If you open the lid, all program settings are canceled.

For the recorder operation, see page 61.

Adjusting the sound (Virtual-Surround • 6-Band Equalizer)

You can vary the virtual sound to create different acoustics, or modify the sound to suit your taste and store it for later use.

The following two effect can be selected.

V-SUR (Virtual-Surround VPT Acoustic Engine)

Provides 4 kinds of virtual surround conditions.

6-BAND EQUALIZER

Provides 6 different sound qualities.

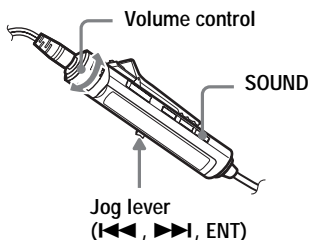

Varying the virtual sound to create different acoustics (Virtual-Surround)

- 1 While playing, press SOUND repeatedly to select “V-SUR”
- 2 Press SOUND for 2 seconds or more.
- 3 Slide the jog lever repeatedly to select the surround mode.

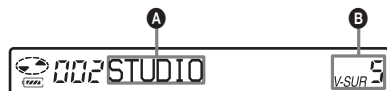

Each time you slide the jog lever, **A** and **B** change as follows:

A	B
STUDIO	V-SUR S

A	B
LIVE	V-SUR L
CLUB	V-SUR C
ARENA	V-SUR A

- 4 Press the jog lever to enter the selected surround mode.

Selecting the sound quality (6-Band Equalizer)

- While playing, press SOUND repeatedly to select "SOUND."
- Press SOUND for 2 seconds or more.
- Slide the jog lever repeatedly to select the sound mode.

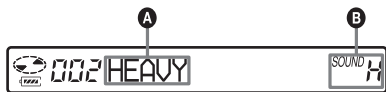

Each time you slide the jog lever, **A** and **B** change as follows:

A	B
HEAVY	SOUND H
POPS	SOUND P
JAZZ	SOUND J
UNIQUE	SOUND U
CUSTOM1	SOUND 1
CUSTOM2	SOUND 2

- 4 Press the jog lever to enter the selected sound mode.

To cancel the procedure

Press **■** for 2 seconds or more.

To cancel the setting

Press SOUND repeatedly until the indication at **B** disappears.

To modify and store the sound

You can modify the sound and store the results in "CUSTOM1" and "CUSTOM2".

- Do steps 1 to 3 of "Selecting the sound quality (6-Band Equalizer)" (page 35), and slide the jog lever until "CUSTOM1" or "CUSTOM2" appears.
- Press the jog lever.
- Slide the jog lever repeatedly to select the frequency.



Frequency (100 Hz)

From the left, you can select 100 Hz, 250 Hz, 630 Hz, 1.6kHz, 4 kHz, or 10 kHz

- 4 Turn the volume control repeatedly to adjust the level.

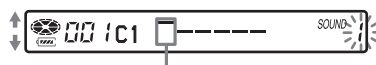

Level (+6 dB)

You can select from among seven levels. -6 dB, -3 dB, 0 dB, +3 dB, +6 dB

- Repeat steps 3 and 4 to adjust the level for each frequency.
- Press the jog lever to enter the selection.

To cancel the procedure

Press **■** for 2 seconds or more.

To return to the preceding setting

Press **■**.

Note

When you assign "SOUND" settings to "CUSTOM1" or "CUSTOM2", the maximum volume setting will be limited to a certain level ("VOL 24") to prevent excessive loudness.

For the recorder operation, see page 62.

Changing playback speed (Digital Pitch Control)

The speed control function is useful for language study and other purpose. This function changes the playback speed without changing the playback pitch. The playback speed can be varied from +100% to -50% the normal speed, in 13 steps.

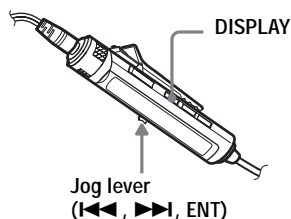

- 1 While playing, press DISPLAY for 2 seconds or more.
- 2 Slide the jog lever repeatedly until "USEFUL" appears in the display, and then press the jog lever.
- 3 Slide the jog lever repeatedly until "DPC" appears in the display, and then press the jog lever.
The player changes to speed-setting mode. Select the speed while listening the sound.

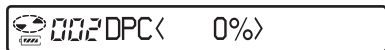

- 4 Slide the jog lever repeatedly to select the desired playback speed, and then press the jog lever to enter the selection.
"DPC" appears in the display.

To cancel the procedure
Press ■ for 2 seconds or more.

To return to the preceding setting

Press ■.



Once you open the lid, the playback speed reverts to the normal speed (0%).

Note

When using digital pitch control, you may hear noise or an echo in the playback.

For the recorder operation, see page 63.

Setting the alarm (Melody Timer)

The alarm is convenient way to remind yourself of important times, such as when to get off the train. The alarm can be set to go off in 1 to 99 minutes. The alarm will also go off while the recorder is stopped.

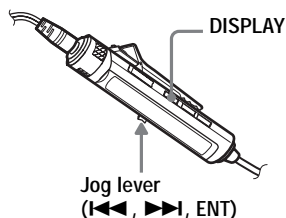

- 1 Press DISPLAY for 2 seconds or more.
- 2 Slide the jog lever repeatedly until "USEFUL" appears in the display, and then press the jog lever.
- 3 Slide the jog lever repeatedly until "M-TIMER" appears in the display, and then press the jog lever.

- 4 Slide the jog lever repeatedly until “ON” appears in the display, and then press the jog lever.
() appears.



- 5 Slide the jog lever repeatedly to select the alarm sound, and then press the jog lever.
You can select from three kinds of sounds.

Display	Alarm sound
TIMER 1	Classical music 1
TIMER 2	Classical music 2
TIMER 3	Classical music 3

- 6 Slide the jog lever repeatedly to select the elapsed time.



Each time you slide the jog lever, the elapsed time setting (TIME :) changes by 1 minute, within a range of 1 to 99 minutes.

- 7 Press the jog lever to enter the setting.
The time remaining until the alarm is shown in the display while the recorder is stopped.

To cancel the procedure
Press  for 2 seconds or more.

To return to the preceding setting
Press .

To check the time remaining until the alarm
Stop playback. The remaining time will appear in the display after a short while.
Do steps 1 to 6 again to display the remaining time during play or play-pause.

To cancel the alarm setting
Select “OFF” in step 4.

To stop the alarm
Press any button.



- If you end the procedure after step 4, the previous alarm setting is automatically used.
- After sounding for one minute, the alarm will automatically stop and the alarm setting will be canceled. If the alarm sounds during stop mode, then the power will automatically turn off 10 seconds after the alarm stops. If the alarm stops while an MD is playing, the playback will continue uninterrupted.

Notes



- The settings will be lost when you start recording.
- The timer will begin counting down from the moment you select “ON” in step 4. The recorder will begin counting down again from the moment you change the elapsed time in step 6.

For the recorder operation, see page 68.

Connecting to a stereo system (LINE OUT)

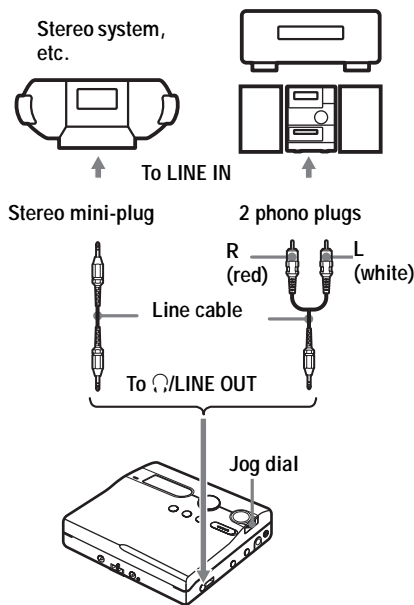
You can listen to the playback sound from connected component. Connect the /LINE OUT jack of the recorder to the LINE IN jacks of an amplifier or a tape player with a line cable.





When connecting a line cable to the /LINE OUT jack of the recorder, be sure to set the “AUDIO OUT” parameter for the /LINE OUT jack.

- 1 Press the jog dial.
- 2 Turn the jog dial until “USEFUL” appears in the display, and then press the jog dial.
- 3 Turn the dial until “AUDIO OUT” appears in the display, and then press the jog dial.

- 4 Turn the jog dial until “LINE OUT” appears in the display, and then press the jog dial to enter the selection.

Notes

- If the “AUDIO OUT” parameter for the /LINE OUT jack is set to “LINE OUT”, VOL + or -, Virtual Surround, or 6-Band Equalizer will not function.
- The “AUDIO OUT” parameter for the /LINE OUT jack cannot be set to “LINE OUT” when the remote control is connected.
- When you connect the headphones/earphones directly to the recorder, set the “AUDIO OUT” parameter for the /LINE OUT jack to “HeadPhone” in step 4.

This section explains the operations that are done on the recorder. For details on operations done on the remote control, see the pages indicated for each operation.

Before editing

You can edit your recordings by adding/erasing track marks or labeling tracks and MDs.

Notes

- Premastered MDs cannot be edited.
- Close the record-protect tab on the side of the MD before editing
- When "TOC Edit" is flashing, the editing results are being recorded.
 - Do not move or jog the recorder.
 - Do not disconnect the power source.
 - The lid becomes locked.

Labeling a track or a disc (Name)

You can name tracks and discs using the recorder's character palette.

Note

To label a group, see page 50.

Available characters

- Capital and small letters of the English alphabet
- Numbers 0 to 9
- ! " # \$ % & () * . ; < = > ?
@ _ ` + - ' , / : _ (space)

Maximum number of characters per name

Track names, group names, and disc name: Approx. 200 each (containing a mixture of all available characters)

Maximum number of characters that can be input per disc

Alphanumeric characters and symbols only: Approx. 120 titles of about 10 characters each (a maximum of about 1,700 characters)

The number of titles that can be stored on a disc depends on the number of characters that are input for track names, group names, and disc name.

About the character palette

During operations on the recorder, characters can be selected from the character palette in the display.

The character palette has the following configuration.

```
ABCDEFGHIJKLMNOPQRSTUVWXYZ 123  
abcdefghijklmnopqrstuvwxyz 456  
. , - ? ! & ' " / @ ; : ( ) # $ * < = > ` + % _ 0 7 8 9
```

Letter input area

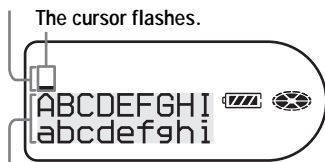

Character palette

Since only a part of the character palette is visible on the display, use the control bar to move the cursor and enter characters.

Note

If you enter the symbol "/" between the characters in disc names such as "abc//def", you may be unable to use the group function.

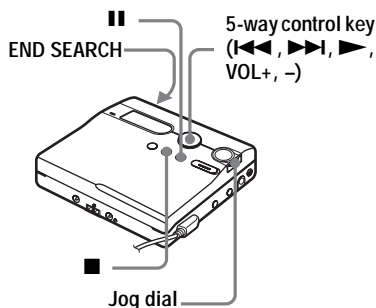

Labeling

You can label a track or disc while the recorder is stopped, recording or playing. Note that if you label a track while the recorder is stopped, the track must be the currently selected.

- 1 Press the jog dial.
- 2 Turn the jog dial until “EDIT” appears in the display, and then press the jog dial.
- 3 Turn the jog dial until “Name” appears in the display, and then press the jog dial.
- 4 Turn the jog dial until the following item appears in the display, and then press the jog dial.

When labeling a track	“🎵 : Name”
When labeling a disc	“🎵 : Name”

The cursor flashes in the letter input area and the track, group, or disc is ready to be labeled.

The cursor flashes.



- 5 Press VOL -.
The cursor shifts from the letter input area to the character palette.

The cursor and character alternate.



- 6 Select a letter using the control key and press ► to enter.

The selected letter appears in the letter input area and the cursor moves to the next input position.

The cursor flashes at the next input position.

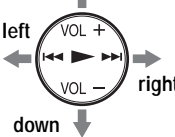

The buttons used for character input and their functions are listed below.

Functions ¹⁾	Operations
To move the cursor in the character palette.	Control key  Turn the jog dial (move the cursor upward or downward).
To select a character in the letter input area.	Turn the jog dial.
To enter a letter.	Press ► Press the jog dial.

Functions ¹⁾	Operations
To move the cursor from the letter input area to the character palette.	Press VOL -.
To move the cursor from the character palette to the letter input area.	Press ■.
To enter a name.	Press the jog dial or ► for 2 seconds or more.
To insert a blank space before the cursor.	Press END SEARCH and VOL + at the same time.
To delete a letter.	Press END SEARCH and VOL - at the same time.
To display “:”, “_” or “/” at the input position in the letter input area.	Press ■■.
To switch capital and small letters.	Press ■■.
To cancel labeling.	Press ■ in the letter input area.

¹⁾ Functions of the buttons or the control may differ depending on when the cursor is in the letter input area or in the character palette.

7 Repeat step 6, and then enter all characters of the label name.

8 Press the jog dial for 2 seconds or more.

A track or disc is labeled.

Note

When the recording is stopped while labeling a track or a disc during recording, or when the recording moves on to the next track while labeling a track, the input at that point is entered automatically.

Re-labeling

You can change the label of the disc or a track by doing the procedure for “Labeling a track or a disc (Name)” (page 39).

To re-label a track:

Start playing the track you want to re-label, and then change the track name while the recorder is playing, or change the track name while the recorder is stopped and the track to be re-labeled is currently selected.

To re-label a disc:

You can re-label the disc while the recorder is stopped, recording, or playing.

To cancel labeling

Press ■ for 2 seconds or more.

To return the preceding settings

Press ■.

Notes

- The recorder is able to display, but cannot label using Japanese “Katakana” characters.
- The recorder cannot rewrite a disc or track name of more than 200 letters that was created by another device.

For the remote control operation, see page 65.

Moving recorded tracks (Move)

You can change the order of the recorded tracks.

Note

To move tracks in a disc with group settings, see page 51.

Example

Move track C (track number 3) from the third to the second track.

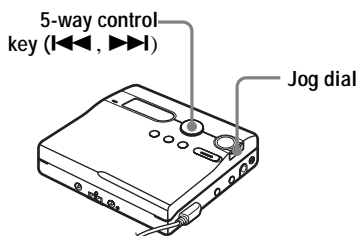
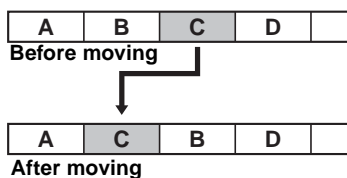

- 1 While playing the track you want to move, press the jog dial.
- 2 Turn the jog dial until "EDIT" appears in the display, and then press the jog dial.
The recorder plays the selected track repeatedly.
- 3 Turn the jog dial until "Move" appears in the display, and then press the jog dial.

- 4 Turn the jog dial until "♪: Move" appears in the display, and then press the jog dial.

The selected track number flashes in the middle row of the display.

If the track has been labeled, press ▶▶ to make the track name appear in the display. Press ◀◀ to display the track number again.

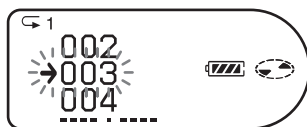

- 5 Turn the jog dial until the destination track number flashes in the display.
For the example, since track C will be moved to track "002", turn the jog dial until "002" flashes in the display.

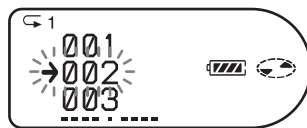

- 6 Press the jog dial to enter the selection.
The track moves to the selected destination track.

To cancel moving

Press ■ for 2 seconds or more.

To return the preceding settings

Press ■.

For the remote control operation, see page 66.

Dividing a track (Divide)

You can divide a track with a track mark, creating a new track from the part following the track mark. You can also make fine adjustments to the track mark position before making the actual division. The track numbers will increase as follows.

This function can be set with the recorder only.

Note

You cannot add a track mark on a track that has been checked-out from your computer.

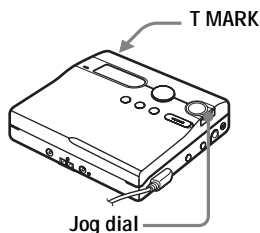
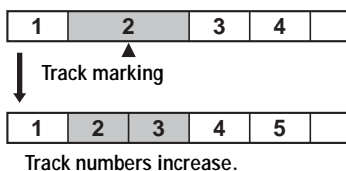

Dividing a track directly

- 1 While playing or pausing an MD, press T MARK on the recorder at the point you want to mark.

“MARK ON” appears in the display, and a track mark is added. The track number will increase by one.

Adjusting the dividing point before dividing a track (Divide Rehearsal)

- 1 While playing, press T MARK for 2 seconds or more.

Four seconds of the track from the point T MARK is pressed is played back repeatedly.

The point T MARK is pressed.

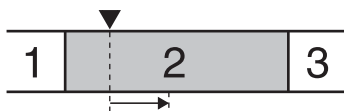

Four seconds of the track plays back repeatedly.

- 2 Turn the jog dial to adjust the point to divide.

Turning the jog dial moves the dividing point forward or backwards. The dividing point can be moved up to a maximum of 8 seconds forward or backwards from the point T MARK was pressed in step 1.

The point T MARK is pressed in step 1.

The dividing point shifts a maximum of 8 seconds forward or backwards.

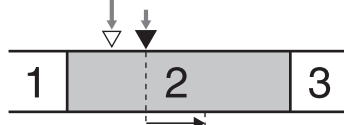

The moved four-second interval plays back repeatedly.

- 3 Press the jog dial to enter the dividing point.

To add track marks while recording (except while synchro-recording)

Press T MARK on the recorder (P MODE/⏏ on the remote control) at the point you want to add a track mark. You can use Auto Time Mark to add track marks automatically at specified intervals (except while digital recording) (page 30).

Combining tracks (Combine)

When you record with analog (line) input, unnecessary track marks may be recorded where recording level is low. You can erase a track mark to combine the tracks before and after the track mark. The track numbers will change as follows. This function can be set with the recorder only.

Notes

- You cannot erase a track mark on a track that has been checked-out from your computer.
- To combine groups or tracks in a disc with group settings, see page 49.
- You cannot combine tracks recorded in different recording mode.

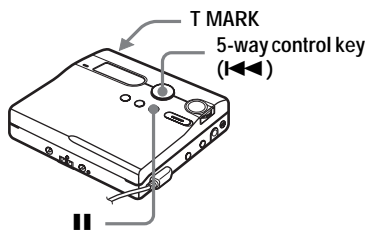
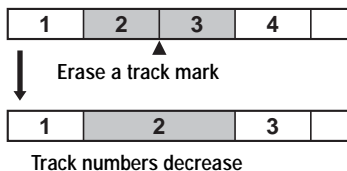

1 While playing the track with the track mark you want to erase, press II to pause.

2 Find the track mark by pressing ⏏ slightly.

For example, to erase the third track mark, find the beginning of the third track. “00:00” appears in the display. “MARK” appears in the display for a few seconds.

3 Press T MARK to erase the mark. “MARK OFF” appears in the display. The track mark is erased and the two tracks are combined.



When you erase a track mark, the date, time, and name assigned to the mark are also erased.

Note

When you erase a track mark between the two consecutive tracks that are assigned into different groups, the second track is re-assigned into the group containing the first track. In addition, if you combine a track that is assigned to a group with a track that is not assigned to a group (two consecutive tracks), the second track takes the same registration setting as the first track.

Erasing tracks and the entire disc (Erase)

You can erase unnecessary tracks or all tracks on a disc.

Note

- You cannot erase tracks that have been checked out from your computer. You cannot erase an entire disc if it contains a checked-out track. In this case, check in the track or tracks to the computer.
- When you erase groups, see page 52.

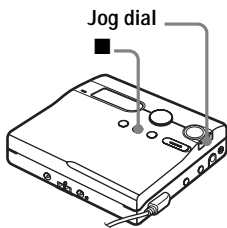

To erase a track

Note that once a recording has been erased, you cannot retrieve it. Make sure of the track you are erasing.

- 1 While playing the track you want to erase, press the jog dial.
- 2 Turn the jog dial until "EDIT" appears in the display, and then press the jog dial.
- 3 Turn the jog dial until "Erase" appears in the display, and then press the jog dial.
- 4 Turn the jog dial until "🎵 : Erase" appears in the display, and then press the jog dial.
"Erase OK?" and "PushENTER" appear in the display.
- 5 Press the jog dial to erase the track.
The track is erased and the next track starts to play. All the tracks after the one erased are automatically renumbered.

To erase a part of a track
Add track marks at the beginning and the end of the part you want to erase, then erase the part (page 43).

To erase the whole disc

You can quickly erase all the tracks and data of the MD at the same time.

Note that once a recording has been erased, you cannot retrieve it. Be sure to check the contents of the disc before you erase it.

- 1 Play the disc you want to erase to check the contents.
- 2 Press ■ to stop.
- 3 Press the jog dial.
- 4 Turn the jog dial until "EDIT" appears in the display, and then press the jog dial.
- 5 Turn the jog dial until "Erase" appears in the display, and then press the jog dial.
- 6 Turn the jog dial until "🎵 : Erase" appears in the display, and then press the jog dial.
"AllErase?" and "PushENTER" appear in the display.
- 7 Press the jog dial to erase the whole disc.
"TOC Edit" appears in the display, and all the tracks will be erased. When erasing is complete, "BLANKDISC" flashes and "00:00" appears in the display.

To cancel erasing

Press ■ for 2 seconds or more.

To return the preceding settings

Press ■.

For the remote control operation, see page 67.

What is the group function?

The group function is provided to allow playback of discs with group settings. The group function is convenient for playback of MDs on which several albums or CD singles have been recorded in MDLP (LP2/LP4) mode.

What is a disc with group settings?

The recorder can operate various functions in units of group; that is tracks that have been recorded on a disc as part of separate groups, as shown below.

Before group settings are made

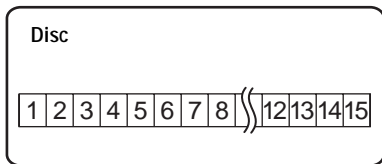

- ↓
- Track 1 to 5 are assigned to group 1.
 - Track 8 to 12 are assigned to group 2.
 - Track 13 to 15 are assigned to group 3.
 - Track 6 to 7 are assigned to no group.

After group assignments have been made

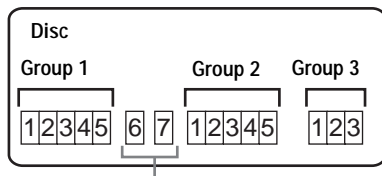

Tracks that were not assigned to a group are treated as being part of "Group -".

You can create a maximum of 99 groups on a disc.

Note

It will not be possible to make a group setting if the tracks, groups and disc name on a disc exceed the maximum number that can be input.

Using the group function when recording

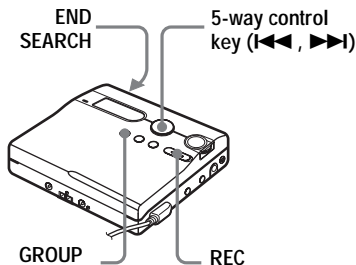

Recording tracks to a new group

During recording, you can add a new group at the end of the currently recorded tracks on a disc.

- 1 While the recorder is stopped, press END SEARCH.
- 2 While pressing GROUP, press and slide REC.
- 3 Play the source sound.
A new group will be added after the current contents on a disc.

To stop recording

Press ■.
The material that was recorded up until ■ was pressed is entered as a new group.

Recording a track to an existing group

You can add a track to an existing group.

- 1 Press GROUP and press ◀◀ or ▶▶ until the group you want to add a track to appears in the display.
- 2 While pressing GROUP, press and slide REC.
- 3 Play the source sound.



- To add a track that is currently playing to a group, stop or pause playing the track first, and then do the procedure from step 2.
- You can set the recorder to always create a new group without pressing the GROUP button. See page 60 for details.

Using the group function when playing

The recorder can operate various playback with a disc which has group setting.

This section explains the operations that are done on the remote control. For details on operations done on the recorder, see page 61.

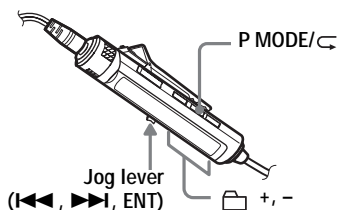

Playing a track in group play

In group play, all groups are played in order, starting with group 1, followed by the unassigned tracks ("Group --"). Playback stops after all the tracks have been played.

- 1 While playing, press P MODE/⏏ until "⏏" appears in the display.



To cue to the start of a group (Group Skip)

- 1 While playing, press ⏏ + or ⏏ -. Pressing the ⏏ - button cues to the first track in the current group. Pressing the button again cues to the first track of the previous group.

Selecting the play mode for group play (Group Play Mode)



The shuffle play and program play function can be used during group play mode.

- 1 Press P MODE/↶ repeatedly.
After normal playback, the following play modes are displayed.

Display	Play mode
 (Normal Group Play)	All tracks in the groups play back once (starting with the first track in group 1).
 , SHUF (In-Group Shuffle)	Shuffle play starts with the group that is currently playing, and continues with the succeeding groups.
 , PGM (Group Program)	The groups are played in the order that you specified.

Repeat play for the selected group play mode (Group Repeat Play)

- 1 While playing in the selected group play mode, press P MODE/↶ for 2 seconds or more.
Playback repeats in the respective group mode.

Display	Play mode
 ↶	Repeat play of tracks within a group.
 SHUF ↶	Repeat shuffle play of tracks within a group.
 PGM ↶	Repeat play for group program.

Playing groups in a desired sequence (Group Program Play)

Do the procedure explained in “Listening to tracks in a desired sequence (Program Play)” (page 34) to playback groups in a desired sequence. You can program up to 10 groups. The sequence of tracks within the groups cannot be changed.

Editing groups

This section explains the operations that are done on the recorder. For details on operations done on the remote control, see the pages indicated for each operation.

Assigning tracks or groups as a new group (Group Setting)

With this function, you can assign existing tracks or groups to a new group, and also you can assign a track that currently belongs to no group to an existing group.

You can create a maximum of 99 groups on a disc.

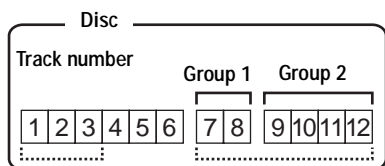

Assigning tracks 1 to 3 to a new group
Assigning group 1 and group 2 to a new group

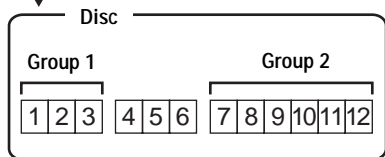

Registration of non-consecutive tracks is not possible (for example, track 3 and tracks 7 and 8 cannot be assigned to a new group).

Track numbers appear according to their order on the disc, not their order within the group.

Notes

- It is not possible to make a group setting if the tracks, groups and disc name on a disc contain more than the maximum number of characters that can be stored.
- The tracks or groups must be sequential. If the desired tracks or groups are not consecutive, you must move them to make them consecutive before you can assign them (“Moving recorded tracks (Move)”, page 42).

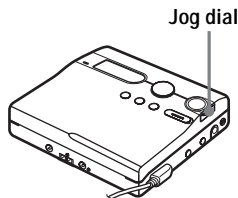

- 1 Press the jog dial.
- 2 Turn the dial until “EDIT” appears in the display, and then press the jog dial.
- 3 Turn the jog dial until “ : Set” appears in the display, and then press the jog dial.
The track number of the first track (“STR”) appears in the display.



- 4 Turn the jog dial until the number of the desired first track appears in the display, and then press the jog dial.
This selects the first track of the new group.

- 5 Turn the jog dial until the number of the desired last track appears in the display, and then press the jog dial to enter the selection.

This selects the last track of the new group and the group can be labeled.

- 6 Label a group (see “Labeling recorded groups” (page 50)).

To cancel the procedure

Press ■ for 2 seconds or more.

To return the preceding setting

Press ■.

Notes

- In step 4, the first track must be either the first track of an existing group or a track that does not belong to a group.
- When selecting the last track in step 5, make sure the track comes after the one selected in step 4. The last track must be either the last track of an existing group or a track that does not belong to a group.

For the remote control operation, see page 67.

Releasing a group setting

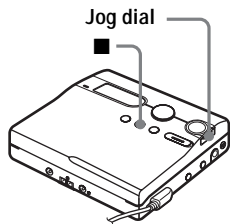

- 1 Select a group you want to release and check the contents (see “Playing a track in group play” (page 47)).
- 2 Press ■.
- 3 Press the jog dial.

- 4 Turn the dial until “EDIT” appears in the display, and then press the jog dial.

- 5 Turn the jog dial until “☐ : Release” appears in the display, and press the jog dial.
“Release?” and “PushENTER” appear in the display.

- 6 Press the jog dial to release a group.
The group setting of the selected group is released.

To cancel the operation

Press ■ for 2 seconds or more.

To return the setting one level before

Press ■.

For the remote control operation, see page 67.

Labeling recorded groups

You can label a group while the recorder is recording or playing a track in the group. You can also label a group while a track in the group is selected and the recorder is stopped.

- 1 Do the procedure of “Labeling” (page 40) and select “☐ : Name” in step 4, and then do steps 5 to 8.

For the remote control operation, see page 66.

Moving a track in a disc with group setting

You can move a track from one group out of the group or to another group. You can also move a track that does not belong to a group to a group to an existing group.

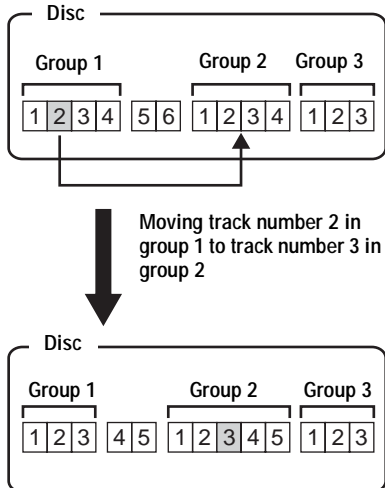

5-way control key
(◀◀, ▶▶)

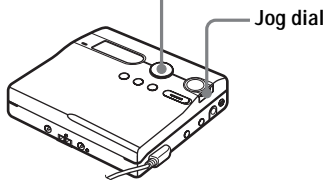

- 1 While playing the track you want to move, press the jog dial.
- 2 Turn the jog dial until “EDIT” appears in the display, and then press the jog dial.
The recorder plays the selected track repeatedly.

- 3 Turn the jog dial until “Move” appears in the display, and then press the jog dial.
- 4 Turn the jog dial until “ : Move” appears in the display, and then press the jog dial.
- 5 When moving a track out of a group, skip this step.
When moving a track to a different group, turn the jog dial until the destination group appears in the display, and then press the jog dial.
If the group has been labeled, press **▶▶** to display the group name. Press **◀◀** to return to the group number display.



- 6 Turn the jog dial until the destination track number (the track number within a group if the destination is a different group) appears in the display, and then press the jog dial to enter your selection.
The selected track number appears in the middle row of the display.
If the track has been labeled, press **▶▶** to make the track name appear in the display. Press **◀◀** to return to the track number display.

To cancel moving
Press **■** for 2 seconds or more.

To return the preceding setting
Press **■**.

For the remote control operation, see page 66.

Changing the order of a group on a disc (Group Move)

5-way control key
(◀◀, ▶▶)

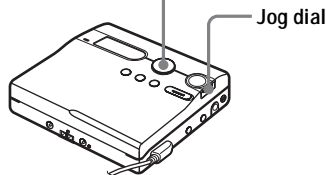

- 1 While playing a track within a group whose order you want to change, press the jog dial.
- 2 Turn the dial until “EDIT” appears in the display, and then press the jog dial.
- 3 Turn the jog dial until “Move” appears in the display, and then press the jog dial.
- 4 Turn the jog dial until “☐ : Move” appears in the display, and then press the jog dial.

The group number to which the currently playing track belongs appears in the middle section of the display. If the group has been labeled, press ▶▶ to display the group name. Press ◀◀ to return to the group number display.

Example: Moving the first group in the disc (Group01) to the position between the second (Group02) and the third (Group03) group.



- 5 Turn the jog dial to select the destination point on the disc, and then press the jog dial to enter the selection.

To cancel moving

Press ■ for 2 seconds or more.

To return the preceding setting

Press ■.

For the remote control operation, see page 66.

To erase a group

You can erase tracks in a selected group.

Note that once a recording has been erased, you cannot retrieve it. Be sure to check the contents of the group before you erase it.

Note

You cannot erase tracks that have been checked out from your computer. You cannot erase a group if it contains a checked-out track. In this case, check in the track or tracks to the computer.

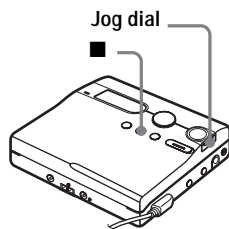

- 1 Select a group you want to erase and check the contents (see “To cue to the start of a group (Group Skip)” (page 47)).
- 2 Press ■.
- 3 Press the jog dial.

- 4 Turn the jog dial until “EDIT” appears in the display, and then press the jog dial.
- 5 Turn the jog dial until “Erase” appears in the display, and then press the jog dial.
- 6 Turn the jog dial until “ : Erase” appears in the display, and then press the jog dial.
The group name and “GP Erase?” appear, and “PushENTER” flashes in the display.
- 7 Press the jog dial to erase the group.
The group is erased.

To cancel erasing

Press  for 2 seconds or more.

To return the preceding setting

Press .

For the remote control operation, see page 67.

Useful settings

The recorder has many menus with useful functions for recording, playback, editing, etc. The following table shows the menu items that you can select. Some items can be set with both the recorder and the remote control, and some can be set with either the recorder or the remote control.

Category	Function	What it does	Operation	Site page
Preparation	Clock setting	Sets the date and time.	recorder	page 58
General operations	Beep on/off	Turns the beep sound on or off.	recorder	page 58
			remote control	page 58
	Jog dial	Turning the jog dial changes the operational direction on the display.	recorder	page 59
Power saving	Maximizes the battery life.	recorder	page 59	
		remote control	page 59	
Recording	Synchro-Recording	Simplifies operations during digital recording.	recorder	page 26
	Long-time recording	Selects the recording mode (SP, LP2, LP4, or monaural).	recorder	page 27
	Selecting the microphone sensitivity	Sets the microphone sensitivity to suit the source sound.	recorder	page 29
	Adding track marks (Divide)	Adds track marks automatically at specified intervals.	recorder	page 30
	Adjusting the recording level	Manually adjusts the recording level.	recorder	page 31
	Selecting the record-starting point	Allows you to specify whether material is overwritten or not when recording.	recorder	page 59
	Group recording	Sets the recorder to create a new group with each recording operation.	recorder	page 60

Category	Function	What it does	Operation	Site page
Playing	Selecting the play mode	Selects the play mode, such as repeat play, program play, etc.	recorder	page 60
			remote control	page 32
	Changing the sound quality	Customizes the surround or equalizer mode settings.	recorder	page 62
			remote control	page 34
	Changing the playback speed	Varies the playback speed without changing the pitch.	recorder	page 63
	Listening to playback from connected component	Outputs sound from the  /LINE OUT jack when listening to a connected component.	recorder	page 38
	Starting playback quickly	Sets the recorder to start playback or cue to a track quickly.	recorder	page 63
remote control			page 63	
Limiting the maximum volume	Sets a limit on the maximum volume to protect your hearing.	recorder	page 64	
		remote control	page 64	
Display	Viewing information	Displays various information such as the remaining time, etc. in the display window.	recorder	pages 25 and 64
			remote control	pages 25 and 32
	Selecting the backlight status	Selects the status of the backlight in the display window on the remote control.	remote control	page 65
Adjusting the contrast	Adjusts the contrast of the display window on the recorder.	recorder	page 65	

Category	Function	What it does	Operation	Site page
Editing	Labeling (Name)	Labels tracks, groups, or the disc.	recorder	page 39 (track and disc) page 50 (group)
			remote control	page 40 (track and disc) page 66 (group)
	Moving	Changes the order of tracks or groups.	recorder	page 42 (track) page 51 (group)
			remote control	page 66
	Erasing	Erases tracks, groups, or the entire disc contents.	recorder	page 44 (track and disc) page 52 (group)
			remote control	page 67
	Assigning tracks to groups	Assigns recorded tracks or groups to a new group.	recorder	page 49
			remote control	page 67
	Releasing a group	Releases group settings.	recorder	page 50
			remote control	page 67
Useful functions	Melody Timer	Sets the alarm to go off after a desired time interval.	recorder	page 68
			remote control	page 36
	Personal Disc Memory	Stores the recorder settings.	recorder	page 68
			remote control	page 68

How to use the menu items

To set the menu items, do the following procedure.

On the recorder:

- 1 Press the jog dial to enter the menu.
- 2 Turn the jog dial to select the item.
- 3 Press the jog dial to enter the selection.
- 4 Repeat steps 2 and 3.
The setting will be entered when you press the jog dial at the last.

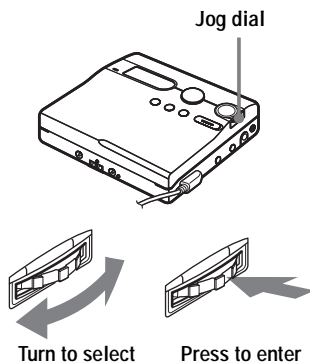

On the remote control:

- 1 Press DISPLAY for 2 seconds or more to enter the menu.
- 2 Slide the jog lever to select the item.
- 3 Press the jog lever to enter the selection.
- 4 Repeat steps 2 and 3.
The setting will be entered when you press the jog lever at the last.

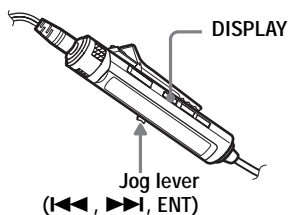

To return the preceding setting

Press ■.

To cancel the operation while setting

Press ■ for 2 seconds or more.

Setting the clock to stamp the recorded time

To stamp the date and time on the MD when you record, you first need to set the clock. Once you set the clock, the recorder will include a time stamp each time you record something. The recording date is not recorded for tracks that are checked out from your computer.

This function can be set with the recorder only.

- 1 When the recorder is stopped, enter the menu and select "OPTION" - "CLOCK SET".

The digits of the year flash.

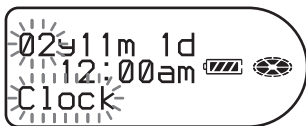

- 2 Change the current year by turning the jog dial, and then press the jog dial.

The digit of the month flashes.

- 3 Repeat step 2 to enter the current month, date, hour, and minute.

When you press the jog dial to enter the minute, the clock starts operating.

If you make a mistake while setting the clock

Press ◀◀ to go back to the wrongly entered item, and then enter the correct value. You can skip a step by pressing ▶▶.

To display the current time

• On the recorder

While the recorder is stopped or recording, enter the menu, and select "DISPLAY" - "Clock".

• On the remote control

While the recorder is stopped or recording, press DISPLAY repeatedly.

To display the time in the 24-hour system

While setting the clock, press T MARK. To display the time in the 12-hour system, press T MARK again.

To maintain the correct time

Once you set the clock, it will keep correct time as long as the recorder is connected to a power source, such as the charged rechargeable battery, alkaline dry battery, or AC power adaptor. However, if no power source is connected, the clock setting will change back to the factory setting after about 3 minutes. When changing the alkaline dry battery, make sure to do it within 3 minutes.

Notes

- Make sure the time is correctly set if you want the time stamp to be accurately recorded for an important recording.
- Under normal conditions, the clock may vary by about plus or minus 3 minutes per month.

Turning off the beep sound

You can turn off/on the beep sound on the recorder and the remote control.

- 1 Enter the menu and select "OPTION" - "BEEP".
- 2 Select "BEEP OFF".

To turn on the beep sound
Select "BEEP ON".

Changing the operational direction of the display

When you turn the jog dial downward, the display scrolls downward. This is the factory setting. You can change the factory setting to scroll in the opposite direction.

This function can be set with the recorder only.

- 1 Enter the menu and select "OPTION"
- "JOG DIAL".
- 2 Select "REVERSE".

To turn the setting to normal
Select "DEFAULT".

Preserving battery power (Power Save Mode)

This function allows you to maximize the operating life of the battery when playing the recorder with headphones/earphones (with a remote control) or a line cable connected to the /LINE OUT jack. Power consumption is reduced by turning off the display when no operation has been made for a while.

- 1 Enter the menu and select "OPTION"
- "PowerMode".
- 2 Select "PowerSave".

To turn the setting to normal
Select "NORMAL".

Recording without overwriting existing material

If you wish to avoid recording over the current contents of an MD, do the following procedure. All new material will then be recorded from the end of the current contents. The recorder is factory set to record over existing material.



This function can be set with the recorder only.

- 1 Enter the menu and select "OPTION"
- "REC-Posi".
- 2 Select "From End".

To start recording over the current contents

Select "From Here".



- To temporarily record without recording over the current contents, press END SEARCH before the start of recording. The recording will begin after the last track, even if "REC-Posi" is set to "From Here" (factory setting). The remaining recordable time on the disc will appear in the display when you press END SEARCH.
- If the group recording setting (" : REC") is set to " : REC ON", the recorder will not overwrite existing materials.

Creating a new group when recording

By sliding REC to the right, you can set the recorder to create a new group automatically each time you record. This is convenient when recording several CDs in succession.

This function can be set with the recorder only.

- 1 While the recorder is stopped, enter the menu and select "REC SET" - "☐ : REC".
- 2 Select "☐ : REC ON".

To turn the setting to normal
Select "☐ : REC OFF".

Selecting the play mode

- 1 Enter the menu and select "PLAY MODE".
- 2 Select the desired play mode.

When you select **A**, **B** appears.

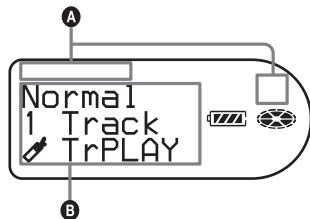

Indication A/B ¹⁾	Play mode
— /Normal	All the tracks are played once.
1/1 Track	A single track is played once.

Indication A/B ¹⁾	Play mode
/ TrPLAY	Bookmarked tracks play back in order of their track number.
SHUF/Shuffle	All tracks are played in random order
PGM/Program	Tracks are played in the order that you specified.

¹⁾ Group play mode appears whenever you play a disc with group settings. For more details, see "Selecting the play mode for group play (Group Play Mode)/Repeat play for the selected group play mode (Group Repeat Play)" (page 61).

- 3 Select "RepeatON" (playing a track repeatedly) or "RepeatOFF".

When you select "RepeatON", appears on **B** and the playback repeats with the play mode selected in step 2.

For the details and the remote control operation, see page 32.

Listening to selected tracks only (Bookmark Play)

To bookmark the tracks

- 1 While playing the track you want to bookmark, press for 2 seconds or more.
The first track of the bookmark play is set.
- 2 Repeat step 1 to bookmark the other tracks.

To play the bookmarked tracks

- 1 Select " TrPLAY?" in step 2 of "Selecting the play mode" (page 60).
- 2 Select "RepeatON" or "RepeatOFF".

To erase bookmarks

While playing the track for which you want to erase the bookmark, press the jog lever for 2 seconds or more.

For the details and the remote control operation, see page 33.

Listening to tracks in a desired sequence (Program Play)

- 1 Select “Program” in step 2 of “Selecting the play mode” (page 60).
- 2 Select “RepeatON” or “RepeatOFF”.
- 3 Turn the jog dial to select a track, and then press the jog dial.

The selected track enters.

Track number Program number



- 4 Repeat step 3 to program more tracks.
 - 5 Press the jog dial for 2 seconds or more.
- The program is set and the playback starts from the first track.

For the details and the remote control operation, see page 34.

Playing a track in group play

- 1 Do steps 1 and 2 of “Selecting the play mode” (page 60) and select “Normal” in step 2.

To cue to the start of a group (Group Skip)

- 1 While playing, press GROUP.
- 2 Press ◀◀ or ▶▶.

For details and the remote control operation, see page 47.

Selecting the play mode for group play (Group Play Mode)/ Repeat play for the selected group play mode (Group Repeat Play)

- 1 Do steps 1 and 2 of “Selecting the play mode” (page 60).
The following group play mode appear after normal play modes.

Display	Play mode
📁:Normal (Normal Group Play)	All tracks in the groups play back once (starting with the first track in group 1).
📁: Shuffle (In-Group Shuffle)	Shuffle play starts with the group that is currently playing, and continues with the succeeding groups.
📁:Program (Group Program)	The groups are played in the order that you specified.

- 2 Select “RepeatON” or “RepeatOFF”.

Playing group in a desired sequence (Group Program Play)

Do the procedure explained in “Listening to tracks in a desired sequence (Program Play)” (page 61) to playback groups in a desired sequence. You can program up to 10 groups. The sequence of tracks within the groups cannot be changed.

For details and the remote control operation, see page 48.

Adjusting the sound (Virtual-Surround • 6-Band Equalizer)

Varying the virtual sound to create different acoustics (Virtual-Surround)

- 1 Enter the menu and select "SOUND" - "V-SUR".
- 2 Turn the jog dial repeatedly to select the surround mode, and then press the jog dial to enter the selection.

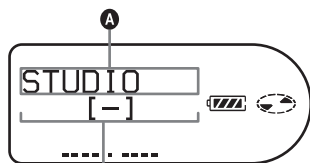

Indication which represents each sound mode appears.

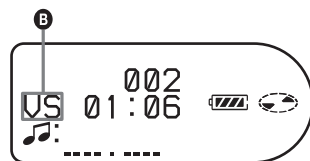

Each time you turn the dial, **A** changes. When you press the jog dial, **B** appears.

A	A
STUDIO	VS
LIVE	VL
CLUB	VC
ARENA	VA

Selecting the sound quality (6-Band Equalizer)

- 1 While playing, enter the menu and select "SOUND" - "SOUND EQ".

- 2 Turn the jog dial repeatedly to select the sound mode and then press the jog dial to enter the selection.

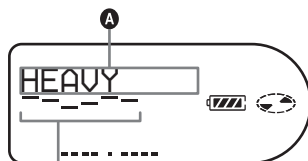

Level of the each frequency (100Hz - 10 kHz)

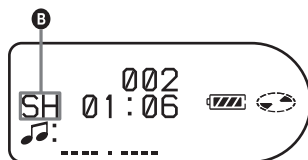

Each time you turn the jog dial, **A** changes. When you press the jog dial, **B** appears.

A	B
HEAVY	SH
POPS	SP
JAZZ	SJ
UNIQUE	SU
CUSTOM1	S1
CUSTOM2	S2

To modify and store the sound

- 1 While the recorder is playing, enter the menu and select "SOUND" - "SOUND EQ" - "CUSTOM1" or "CUSTOM2".
- 2 Press **◀** or **▶** to select the frequency.



Frequency (100 Hz)

From the left, you can select 100 Hz, 250 Hz, 630 Hz, 1.6kHz, 4 kHz, 10 kHz

3 Press VOL + or – to adjust the level.

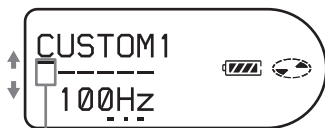

Level (+6 dB)

You can select from among seven levels.
–6 dB, –3 dB, 0 dB, +3 dB, +6 dB

4 After selecting the level, press the jog dial to enter.

To cancel the setting
Select “SOUND OFF”.

For details and the remote control
operation, see page 34.

Changing playback speed (Digital Pitch Control)

- 1 While the recorder is playing, enter the menu and select “USEFUL” - “DPC”.
- 2 Turn the jog dial to select the desired playback speed, and then press to enter.

Example: while selecting the playback
speed of +50% the normal.

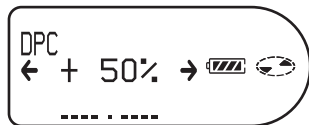

For details and the remote control
operation, see page 36.

Starting the playback quickly (Quick Mode)

After pressing the playback button or
cuing to the track, the playback can start
quickly.

- 1 While the recorder is stopped or
playing, enter the menu and select
“OPTION” - “PowerMode”.
- 2 Select “QUICK”.

Display window on the recorder



Display window on the remote control



To switch back to the normal
setting
Select “NORMAL”.

Notes

- When the power mode is set to “QUICK”, the power remains on within the recorder even when nothing appears in the display. This leads to a shorter battery life. For this reason, it is recommended that you charge the battery daily.
- If no recorder operation (including opening or closing of the lid) occurs for 17 hours, the power in the recorder automatically turns off. For this reason, the next time you start playback or do another operation, the recorder will not respond quickly. The unit, however, will return to quick mode afterwards.

Protecting your hearing (AVLS)

The AVLS (Automatic Volume Limiter System) function keeps down the maximum volume to protect your ears.

- 1 Enter the menu and select “OPTION” - “AVLS”.
- 2 Select “AVLS ON”.
When you try to turn the volume too high, “AVLS” appears in the display. The volume is kept to a moderate level.

To cancel the AVLS
Select “AVLS OFF”.

Viewing various information

- 1 While playing, enter the menu and select “DISPLAY”.
- 2 Select the information you want.

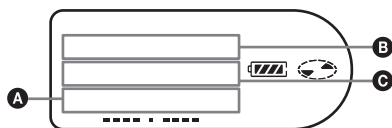

Indication: **A**(selected item)/**B**/**C**

A (selected item)	B	C
— (LapTime)	Track number	Elapsed time
1 Remain	Track number	Remaining time of the current track
GP Remain	Group name	Remaining time after the current location in the group

A (selected item)	B	C
AllRemain	Number of tracks after the current track	Remaining time after the current location in the disc
Track name (Title)	Disc name	Group name
Sound mode name (Sound)	Indication of the selected sound mode	—
RecDate	Recorded date	Recorded time

Note

Depending on the group settings, the operating conditions, and the disc settings, you may not be able to select certain indications or the indications may appear different.

For details and the remote control operation, see page 32.

Turning on/off the backlight

The backlight of the display window of the remote control can be set to remain on or off.

This function can be set with the remote control only.

1 While the recorder is stopped, enter the menu and select “OPTION” - “BACKLIGHT”.

2 Select the desired item.

Display	Setting
AUTO	The backlight lights when you operate the recorder or the remote control, and automatically turns off when no operation is made for a few seconds.
ON	The backlight lights when the recorder is operating.
OFF	The backlight stays off.

Adjusting the contrast of the display window (Contrast Adjustment)

You can adjust the contrast of the display window on the recorder.

This function can be set with the recorder only.

1 While the recorder is stopped, enter the menu and select “OPTION” - “CONTRAST”.

2 Turn the jog dial to adjust the contrast, and then press the jog dial to enter the selection.

Note

You cannot adjust the contrast with the remote control, nor can you adjust the contrast of the display on the remote control.

Labeling (Name)

1 Enter the menu and select “EDIT” - “Name”.

2 Select one of the following.

When labeling a track	“🎵 : Name”
When labeling a disc	“🌀 : Name”

3 Turn the volume control repeatedly to select a letter and press the jog lever to enter.

The selected letter stops flashing and the cursor moves to the next input position.

The cursor flashes at the next input position.



The buttons and control used for character input and their functions are listed below.

Functions	Operation
To move the cursor to the left or right.	Slide the jog lever (◀◀, ▶▶)
To change the letter to the one before/next one.	Turn the volume control (VOL+, -).
To enter a letter.	Press the jog lever (▶▶/ENT).
To enter a name.	Press the jog lever for 2 seconds or more (▶▶/ENT).
To switch between capital letters, small letters, and numbers/marks.	Press P MODE/↶.
To insert a blank space.	Press ☐ +.
To delete a letter.	Press ☐ -.
To cancel labeling.	Press ■ for 2 seconds or more.

continued

4 Repeat step 3 and enter all characters of the label name.

5 Press the jog lever for 2 seconds or more.

For details and the recorder operation, see page 39.

Labeling recorded groups

1 Select “ : Name” in step 2 of “Labeling (Name)” (page 65) and do steps 3 to 5 to label a group.

For the details and the recorder operation, see page 50.

Re-labeling

You can re-label recordings by following the procedure of “Labeling (Name)” (page 65).

For details and the recorder operation, see page 41.

Moving recorded tracks

1 While playing the track you want to move, enter the menu and select “EDIT” - “Move” - “ : Move”.

Example: When moving track number 3, “Tr003” appears in the display.



2 Slide the jog lever repeatedly until the destination track number appears in the display.

Example: When moving to track number 2, “Tr002” appears in the display.



3 Press the jog lever to enter the selection.

For details and the recorder operation, see page 42.

Moving a track in a disc with group setting

1 While playing the track you want to move enter the menu and select “EDIT” - “Move” - “ : Move”.

2 When moving a track out of a group, skip this step.
When moving a track into a different group, slide the jog lever until the destination group appears in the display, and then press the jog lever.



3 Slide the jog lever repeatedly until the number of the destination track (within a group when moving into a different group) appears in the display, and then press to enter the selection.

For details and the recorder operation, see page 51.

Changing the order of a group on a disc (Group Move)

1 While playing a track within a group whose order you want to change, enter the menu and select - “EDIT” - “Move” - “ : Move”.

2 Slide the jog lever repeatedly to select a destination point on the disc, and then press to enter the selection.

Example: When moving the first group (GP01) to the second group (GP02)

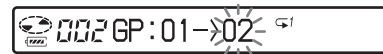



For details and the recorder operation, see page 52.

Erasing tracks, the entire disc or groups (Erase)

Erasing tracks



- 1 While playing the track you want to erase, enter the menu and select “EDIT” - “Erase” - “ : Erase”. “Erase OK?” and “PushENTER” appear in the display.
- 2 Press the jog lever to erase a track.

To erase the whole disc

- 1 Play the disc you want to erase to check the contents.
- 2 Press  to stop.
- 3 Enter the menu and select “EDIT” - “Erase” - “ : Erase”. “AllErase?” and “PushENTER” appear in the display.
- 4 Press the jog lever to erase the whole disc.

For details and the recorder operation, see page 44.

To erase a group

- 1 Select a group you want to erase and check the contents (see “To cue to the start of a group (Group Skip)” (page 47)).
- 2 Press  to stop.
- 3 Enter the menu and select “EDIT” - “Erase” - “ : Erase”. “GP Erase?” and “PushENTER” appear in the display.
- 4 Press the jog lever to erase a group.

For details and the recorder operation, see page 52.

Assigning tracks or groups as a new group (Group Setting)



- 1 Enter the menu and select “EDIT” - “ : Set”.
- 2 Slide the jog lever repeatedly until the number of the desired first track appears in the display, and then press the jog lever.



- 3 Slide the jog lever repeatedly until the number of the desired last track appears in the display, and then press the jog lever.
- 4 Label a group (see “Labeling recorded groups” (page 66)).

For details and the recorder operation, see page 49.

Releasing a group setting

- 1 Select a group that you want to release and check the contents (see “To cue to the start of a group (Group Skip)” (page 47)).
- 2 Press .
- 3 Enter the menu and select - “EDIT” - “ : Release”. “Release?” and “PushENTER” appear in the display.
- 4 Press the jog lever to enter the selection.

For details and the recorder operation, see page 50.

Using the alarm (Melody Timer)

- 1 Enter the menu and select “USEFUL” - “M-TIMER” - “ON”.

(●) lights up in the display and the alarm sound can be selected.

- 2 Turn the jog dial repeatedly to select the alarm sound, and then press the jog dial.

See step 5 of “Setting the alarm (Melody Timer)” (page 37) for the varieties of alarm sound.

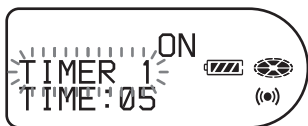

- 3 Turn the jog dial to select the elapsed time.



One rotation of the control changes the elapsed time setting (TIME :) by 1 minute, within a range of 1 to 99 minutes. To change the time quickly, keep turning the jog dial.

- 4 Press the jog dial to enter the selection.

The time remaining until the alarm is shown in the display while the recorder is stopped.

To cancel the alarm setting
Select “OFF”.

To stop the alarm
Press any button.

For details and the remote control operation, see page 36.

Storing the settings for individual discs (Personal Disc Memory)

The recorder can store the various settings for each disc, and then retrieve them automatically whenever the disc is inserted.

The following setting can be stored:

- Volume
- Play mode
- Group mode
- Program play
- Sound quality (Virtual Surround/6-Band Equalizer)
- Playback speed (Digital Pitch Control)
- Bookmark

- 1 When the recorder is stopped, playing, or play-paused, enter the menu and select “USEFUL” - “PERSONAL”.

“Entry?” appears in the display.

Display window on the recorder

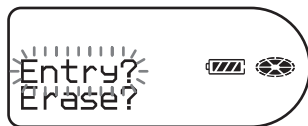

Display window on the remote control

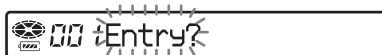

- 2 Press the jog dial (on the recorder) or jog lever (on the remote control) to enter the selection.

“Entry OK” appears in the display and the disc settings are stored in the recorder.

Erasing the disc information

- 1 Insert the disc whose information is to be erased and verify its contents.
- 2 Select “Erase?” after step 1.
“Erase OK” appears in the display and the disc information is erased.

Note

If you try to erase the disc information of a disc that have never been stored, “No Entry!” appears in the display for a few seconds.



“PERSONAL” appears when the disc with its setting stored is inserted.

Notes

- The settings for up to 20 discs can be stored. Any settings stored afterwards will replace the settings for the least used disc among the 20.
- If you add tracks or perform an editing operation (not including labeling) to a disc whose settings have been stored on the recorder, the disc will no longer be recognizable by the recorder and the stored information will become useless. In this case, store the settings again.

List of menus



Menus on the recorder

Items listed under “Menu 1” are the selectable items which appear when you press the jog dial, items listed under “Menu 2” are the selectable items which appear when you select an item in Menu 1, and “Menu 3” are the selectable items which appear when you select an item in Menu 2.











Note

Different indication may be displayed depending on the operating conditions and disc settings.

Menu 1	Menu 2	Menu 3
EDIT	Name	: Name ↔ : Name ↔ : Name
	: Set	—
	: Release	—
	Move	: Move ↔ : Move
	Erase	: Erase ↔ : Erase ↔ : Erase
DISPLAY	LapTime	—
	RecRemain (while recording and stopped)/1 Remain (while playing)	—
	GP Remain	—
	AllRemain	—
	Title	—
	Sound	—
	Clock(while recording and stopped)/Rec Date (while playing)	—
PLAY MODE	Normal	RepeatOFF (factory setting) ↔ RepeatON
	1 Track	
	TrPLAY	
	Shuffle	
	Program	
	:Normal	
	: Shuffle	
	:Program	
SOUND	SOUND OFF	—
	V-SUR	STUDIO ↔ LIVE ↔ CLUB ↔ ARENA
	SOUND EQ	HEAVY ↔ POPS ↔ JAZZ ↔ UNIQUE ↔ CUSTOM1 ↔ CUSTOM2

Menu 1	Menu 2	Menu 3
USEFUL	PERSONAL	Entry? ↔ Erase?
	M-TIMER	OFF (factory setting) ↔ ON
	DPC	—
	AUDIO OUT	HeadPhone (factory setting) ↔ LINE OUT
REC SET	REC MODE	SP (factory setting) ↔ LP2 ↔ LP4 ↔ MONO
	RecVolume	Auto REC (factory setting) ↔ ManualREC
	TIME MARK	OFF (factory setting) ↔ ON
	MIC SENS	SENS HIGH (factory setting) ↔ SENS LOW
	 : REC	 : REC OFF (factory setting) ↔  : REC ON
	SYNC REC	SYNC OFF (factory setting) ↔ SYNC ON
OPTION	AVLS	AVLS OFF (factory setting) ↔ AVLS ON
	BEEP	BEEP OFF ↔ BEEP ON (factory setting)
	REC-Posi	From Here (factory setting) ↔ From End
	PowerMode	NORMAL (factory setting) ↔ QUICK ↔ PowerSave
	CONTRAST	—
	JOG DIAL	DEFAULT (factory setting) ↔ REVERSE
	CLOCK SET	—

On the remote control

Menu 1	Menu 2	Functions
EDIT	Name	 : Name ↔  : Name ↔  : Name
	 : Set	—
	 : Release	—
	Move	 : Move ↔  : Move
	Erase	 : Erase ↔  : Erase ↔  : Erase
USEFUL	PERSONAL	Entry? ↔ Erase?
	M-TIMER	OFF (factory setting) ↔ ON
	DPC	—
OPTION	AVLS	AVLS OFF (factory setting) ↔ AVLS ON
	BEEP	BEEP OFF ↔ BEEP ON (factory setting)
	BACKLIGHT	AUTO (factory setting) ↔ ON ↔ OFF
	PowerMode	NORMAL (factory setting) ↔ QUICK ↔ PowerSave

Power sources

You can use the recorder on house current or as follows.

- a nickel metal hydride rechargeable battery NH-14WM
- LR6 (size AA) alkaline dry battery (used with the supplied dry battery case)

It is preferable to use the recorder on house current when recording for a long time. When powering the recorder with batteries, make sure the rechargeable battery is fully charged or that the alkaline dry battery is new to prevent battery exhaustion in the middle of a recording operation.

Battery life¹⁾

The battery life may be shorter due to operating conditions, the temperature of the location, or the type of alkaline dry battery being used.

When recording

(Unit: approx.hours)(JEITA²⁾)

Batteries	SP Stereo	LP2 Stereo	LP4 Stereo
Nickel metal hydride rechargeable battery ³⁾	11	16	20
LR6 (SG) Sony alkaline dry battery ⁴⁾	11	16	21
Nickel metal hydride rechargeable battery ³⁾ + One LR6 (SG) ⁴⁾	29	38	50

¹⁾ Measured with the power save mode on (see "Preserving battery power (Power Save Mode)" (page 59)).

²⁾ Measured in accordance with the JEITA (Japan Electronics and Information Technology Industries Association) standard.

³⁾ When using a 100% fully charged nickel metal hydride rechargeable battery.

⁴⁾ When using a Sony LR6 (SG) "STAMINA" alkaline dry battery (produced in Japan).

When playing

(Unit: approx.hours)(JEITA)

Batteries	SP Stereo	LP2 Stereo	LP4 Stereo
Nickel metal hydride rechargeable battery	31	38	45
LR6 (SG) Sony alkaline dry battery	47	57	69
Nickel metal hydride rechargeable battery + One LR6 (SG)	80	95	114

When to replace the batteries

When the dry battery or rechargeable battery is weak, flashing  or "LOW BATT" appears in the display. Replace the dry battery or charge the rechargeable battery.

The battery level indicator is approximate. It may be more or less than the indication depending on the operating condition or the operating environment.

Note

Stop the recorder before replacing the battery.

Precautions

On safety

Do not put any foreign objects in the DC IN 3V jack.

On power sources

- Use house current, nickel metal hydride rechargeable battery, LR6 (size AA) battery, or car battery.
- For use in your house: For the supplied battery charging stand, use the AC power adaptor supplied with this recorder. Do not use any other AC power adaptor since it may cause the recorder to malfunction.

Polarity of the plug



- Connect the AC power adaptor to an easily accessible AC outlet. Should you notice an abnormality in the AC power adaptor, disconnect it from the AC outlet immediately.
- The recorder is not disconnected from the AC power source (mains) as long as it is connected to the wall outlet, even if the recorder itself has been turned off.
- If you are not going to use this recorder for a long time, be sure to disconnect the power supply (AC power adaptor, dry battery, rechargeable battery, or car battery cord). To remove the AC power adaptor from the wall outlet, grasp the adaptor plug itself; never pull the cord.

On heat build-up

Heat may build up in the recorder if it is used for an extended period of time. This, however, is not a malfunction.

On installation

- Never use the recorder where it will be subjected to extremes of light, temperature, moisture or vibration.
- Never wrap the recorder in anything when it is being used with the AC power adaptor. Heat build-up in the recorder may cause malfunction or damage.

On the headphones/earphones

Road safety

Do not use headphones/earphones while driving, cycling, or operating any motorized vehicle. It may create a traffic hazard and is illegal in many areas. It can also be potentially dangerous to play your recorder at high volume while walking, especially at pedestrian crossings. You should exercise extreme caution or discontinue use in potentially hazardous situations.

Preventing hearing damage

Avoid using headphones/earphones at high volume. Hearing experts advise against continuous, loud and extended play. If you experience a ringing in your ears, reduce the volume or discontinue use.

Caring for others

Keep the volume at a moderate level. This will allow you to hear outside sounds and to be considerate of the people around you.

On the remote control

The supplied remote control is designed for use with this recorder only. The recorder cannot be operated with a remote control that was supplied with another device.

On charging

- The supplied battery charging stand can be used only with this recorder. Any other models cannot be charged.
- Do not use the supplied battery charging stand to charge any other battery besides the supplied one or the one designated for it (NH-14WM).
- Be sure to use the supplied AC power adaptor.
- Charge the rechargeable battery at a temperature of +5°C (+41°F) to +40°C (+104°F).
- Though the battery charging stand and the battery may become hot during the charging procedure, this poses no danger.
- If you are charging the battery for the first time or after a long period of disuse, the battery may not charge up to its rated capacity. This is a normal characteristic. After you use and recharge the battery a few times, it will return to its normal charge capacity.

- If the capacity of the rechargeable battery drops to half the normal amount, replace with the new one.

On the dry battery case

The supplied dry battery case is designated for this recorder only.

On the MiniDisc cartridge

- When carrying or storing the MiniDisc, keep it in its case.
- Do not break open the shutter.
- Do not place the cartridge where it will be subject to light, extreme temperatures, moisture or dust.
- Attach the supplied MD label only in the space designated for it on the disc. Do not stick it on any other disc surface.

On cleaning

- Clean the recorder casing with a soft cloth slightly moistened with water or a mild detergent solution. Do not use any type of abrasive pad, scouring powder or solvent such as alcohol or benzene as it may mar the finish of the casing.
- Wipe the disc cartridge with a dry cloth to remove dirt.
- Dust on the lens may prevent the unit from operating properly. Be sure to close the disc compartment lid after inserting or ejecting an MD.
- To obtain the best sound quality, use a dry cloth to wipe the plugs of the headphones/earphones or the remote control. Dirty plugs may cause sound distortion or intermittent breaks in the sound.

On batteries

Incorrect battery usage may lead to leakage of battery fluid or bursting battery. To prevent such accidents, observe the following precautions:

- Install the + and – poles of the batteries correctly.
- Do not try to recharge dry battery.
- When the recorder is not to be used for a long time, be sure to remove the batteries.
- If a battery leak should develop, carefully and thoroughly wipe away battery fluid from the battery compartment before inserting new ones.

On mechanical noise

The recorder gives off mechanical noise while operating, which is caused by the power-saving system of the recorder and it is not a problem.

To protect a recorded MD

To record-protect an MD, slide open the tab at the side of the MD. In this position, the MD cannot be recorded. To record again, slide the tab back so the tab is visible.

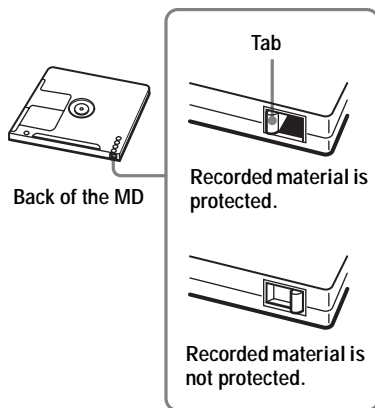

On maintenance

Clean the terminals periodically with a cotton swab or a soft cloth as illustrated.

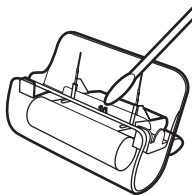

If you have any questions or problems concerning your recorder, please consult your nearest Sony dealer. (If a trouble occurred when the disc was in the recorder, we recommend that the disc be left in the recorder when you consult your Sony dealer so that the cause of trouble may be better understood.)

Specifications

Audio playing system

MiniDisc digital audio system

Laser diode properties

Material: GaAlAs

Wavelength: $\lambda = 790$ nm

Emission duration: continuous

Laser output: less than 44.6 μ W

(This output is the value measured at a distance of 200 mm from the lens surface on the optical pick-up block with 7 mm aperture.)

Recording and playback time (when using MDW-80)

Maximum 160 min. in monaural

Maximum 320 min. in LP4 stereo

Revolutions

350 rpm to 3,600 rpm (CLV)

Error correction

ACIRC (Advanced Cross Interleave Reed

Solomon Code)

Sampling frequency

44.1 kHz

Sampling rate converter

Input: 32 kHz/44.1 kHz/48 kHz

Coding

ATRAC (Adaptive TRansform Acoustic

Coding)

ATRAC3 — LP2/LP4

Modulation system

EFM (Eight to Fourteen Modulation)

Frequency response

20 to 20,000 Hz \pm 3 dB

Inputs¹⁾

MIC: stereo mini-jack

(minimum input level 0.25 mV)

Line in:

stereo mini-jack for analog input

(minimum input level 49 mV)

optical (digital) mini-jack for optical

(digital) input

Outputs

ϕ /LINE OUT²⁾: stereo mini-jack (dedicated

remote control jack)/194 mV (10 k Ω)

Maximum output (DC)²⁾

Headphones:

4 mW + 4 mW (16 Ω)

Power requirements

Sony AC Power Adaptor connected at the DC IN 3V jack:

120 V AC, 60 Hz (Models for USA, Canada, Mexico and Taiwan)

230 V AC, 50/60 Hz (Models for continental Europe)

240 V AC, 50 Hz (Model for Australia)

220 V AC, 50 Hz (Models for China and Argentine)

230 V AC, 50 Hz (Models for U.K. and Hong Kong)

100 - 240 V AC, 50/60 Hz (Other models)

The recorder:

Nickel metal hydride rechargeable battery

NH-14WM, 1.2 V, 1350 mAh (MIN), Ni-MH

LR6 (size AA) alkaline battery

Battery charging stand:

AC power adaptor DC 3V

Battery operation time³⁾

See "Battery life" (page 72)

Dimensions

Approx. 78.9 \times 72.2 \times 15.9 mm (w/h/d)

(³/₈ \times ²/₈ \times ²/₃₂ in.) (excluding projecting parts and controls)

Mass

Approx. 93 g (3.3 oz)

¹⁾The LINE IN (OPT) jack is used to connect either a digital (optical) cable or a line (analog) cable.

²⁾The ϕ /LINE OUT jack connects either headphones/earphones or a line cable.

³⁾Measured in accordance with JEITA.

US and foreign patents licensed from Dolby Laboratories.

Design and specifications are subject to change without notice.

Optional accessories

Optical Cable

POC-151HG, POC-152HG, POC-MZ1,

POC-MZ2, POC-15B, POC-15AB, POC-DA12SP

Line Cable

RK-G129, RK-G136

Stereo Microphones ECM-719, ECM-MS907, ECM-MS957

MDR-series Stereo Headphones/earphones*

SRS-series Active Speakers

Recordable MDs MDW-series

Your dealer may not handle some of the above listed accessories. Please ask the dealer for detailed information about the accessories in your country.

* When using optional headphones, use only headphones/earphones with stereo mini plugs. You cannot use headphones/earphones with micro plugs.

Troubleshooting

If a problem occurs during recorder operation, follow the steps described below before consulting the nearest Sony dealer. If any messages appear, it is recommended to take notes.









- 1 Check to see if the problem is listed in, “Troubleshooting” (page 77).
Check “Messages” (page 85) for the problem as well.
- 2 If after step 1 you still cannot solve the problem, consult your nearest Sony dealer.

While charging

Symptom	Cause/Solution
The rechargeable battery does not start charging. The rechargeable battery cannot be fully charged.	<ul style="list-style-type: none">• The rechargeable battery or the dry battery has been inserted incorrectly or the AC power adaptor has been connected incorrectly. ➔ Insert the battery correctly or connect the AC power adaptor correctly.• The terminals of the battery charging stand is dirty. ➔ Clean the terminals with a dry cloth.• Because of the battery’s characteristics, the capacity of the rechargeable battery may be smaller than normal when it is used for the first time or after a long period of disuse. ➔ Charge and discharge the battery several times. The normal battery life will be restored.• The rechargeable battery is drained (nothing appears in the display window). ➔ Charge the rechargeable battery. It takes one minute after placing the recorder on the battery charging stand for an indication to appear and charging to start. If charging does not start even after a minute, replace the recorder on the battery charging stand again.
The rechargeable battery has become drained even when the recorder was not used for a while.	<ul style="list-style-type: none">• The quick mode was set to “QUICK”. ➔ If you set the quick mode to “QUICK”, the power stays on inside recorder even when there is no operation, causing the battery life to shorten. If the battery is not fully charged, the rechargeable battery may become drained after a while. If this happens, charge the rechargeable battery again (page 63).
Even when fully charged, the life of the battery is only about half what it normally is.	<ul style="list-style-type: none">• The useful life of the rechargeable battery may be ending. ➔ Replace the rechargeable battery with the new one.

Symptom	Cause/Solution
The battery charging stand and the recorder become hot during the charging procedure.	<ul style="list-style-type: none"> This is normal and poses no danger.

While recording

Symptom	Cause/Remedy
The recorder overwrites existing materials when record.	<ul style="list-style-type: none"> The record starting-position setting (“REC-Posi”) is set to “From Here”. ➔ Set “REC-Posi” setting to “From End”.
The recording starts from the end of the disc even when “REC-Posi” is set to “From Here”.	<ul style="list-style-type: none"> The group recording (“: REC”) is set to “: REC ON”. (You cannot overwrite tracks when “: REC” is set to “: REC ON”). ➔ Set the group recording setting to “: REC OFF” (page 60).
“REC-Posi” (the record-starting point) cannot be set to “From Here”.	<ul style="list-style-type: none"> The group recording (“: REC”) is set to “: REC ON”. ➔ Set the group recording setting to “: REC OFF” (page 60), and then set “REC-Posi” to “From Here”.
Recording cannot be done correctly.	<ul style="list-style-type: none"> Audio sources may not be securely connected. ➔ Disconnect the audio sources once and connect them again (pages 20, 26, 28). There is no digital signal from the portable CD player. ➔ When recording digitally from a portable CD player, use the AC power adaptor and disable the anti-skip function (such as ESP) on the CD player (page 22). The analog recording was made using a connecting cord with an attenuator. ➔ Use a connecting cord without an attenuator. Recording level is too small to record (when adjusting the recording level manually). ➔ Pause the recorder and adjust the recording level (page 31). The power sources was disconnected or a power outage occurred during recording. ➔ The recording result is not recorded on the disc. Make recording again. The premastered MD is inserted. ➔ Replace to the recordable MD. The remaining recordable time on the disc is 12 seconds or less (“DISC FULL” appears). ➔ Replace the disc.

Symptom	Cause/Remedy
Recording stops automatically in the middle of a recording operation.	<ul style="list-style-type: none"> • You tried to overwrite a track which is checked out from the computer. (Tracks that are checked out from the computer cannot be overwritten. The recording stops automatically.) <ul style="list-style-type: none"> ➔ Check the checked-out track back into the computer. ➔ Record from the end of the disc.
Stereo sound is heard in the headphones/earphones while recording in monaural.	<ul style="list-style-type: none"> • This is normal. During digital recording, the sound will be stereo in the headphones/earphones, even though the recorded sound is monaural.
Momentary noise is heard when recording.	<ul style="list-style-type: none"> • Due to the special digital audio compression technology used in LP4 stereo mode, momentary noise may occur on very rare occasions with certain sound sources. <ul style="list-style-type: none"> ➔ Record in SP or LP2 mode.
The lid does not open after recording.	<ul style="list-style-type: none"> • The lid does not open until “TOC Edit” disappears in the display.
“TR FULL” appears even before the disc has reached the maximum recording time (60, 74, or 80 minutes) and the recording cannot be done.	<ul style="list-style-type: none"> • This is due to the MiniDisc system limitation. When 254 tracks have been recorded on the disc, “TR FULL” appears regardless of the total recorded time. More than 254 tracks cannot be recorded on the disc. <ul style="list-style-type: none"> ➔ To continue recording, erase unnecessary tracks.
The remaining recording time does not increase even after erasing numerous short tracks.	<ul style="list-style-type: none"> • This is due to the MiniDisc system limitation. Tracks of under 12 seconds (in SP stereo), 24 seconds (in LP2 stereo mode or monaural), or 48 seconds (in LP4 stereo mode) in length are not counted and so erasing them may not lead to an increase in the recording time.
The total recorded time and the remaining time on the disc may not total the maximum recording time (60, 74, or 80 minutes).	<ul style="list-style-type: none"> • This is due to the MiniDisc system limitation. Normally, recording is done in minimum units of approximately 2 seconds (in SP stereo), 4 seconds (in LP2 stereo mode or monaural), or 8 seconds (in LP4 stereo mode). When recording is stopped, the last unit of recording always uses this unit of 2 seconds, 4 seconds, or 8 seconds even if the actual recording is shorter. Likewise, when recording is restarted after the stop, the recorder will automatically insert a blank space amounting to 2 seconds, 4 seconds, or 8 seconds before the next recording. (This is to prevent accidental erasing of a previous track whenever a new recording is started). Therefore, the actual recording time will decrease whenever a recording is stopped by a maximum of 6 seconds, 12 seconds, or 24 seconds.

Symptom	Cause/Remedy
You cannot check out tracks that will fill up the remaining recording time on the disc.	<ul style="list-style-type: none"> The minimum recordable time on a disc is normally 2 seconds in stereo, 4 seconds in LP2 stereo mode, and 8 seconds in LP4 stereo mode. When you check out a track from your computer, the recorder needs a 2-second (or 4- or 8-second) space for a track even if the track is under 2 seconds (or 4 or 8 seconds) in length. Also, the recorder inserts a 2-second (or 4 -or 8-second) space in between tracks during check out so as not to overwrite the previous track by mistake. For this reason, the recorder needs an additional 6 seconds (or 12 or 24 seconds) for each track. This reduces the maximum recording time for each track by 6 seconds (or 12 or 24 seconds) during check out.
“TR FULL” appears even before the disc has reached the maximum track number or recording time.	<ul style="list-style-type: none"> This is due to the MiniDisc system limitation. Repeated recording and erasing may cause fragmentation and scattering of data. Although those scattered data can be read, each fragment is counted as a track. In this case, the number of tracks may reach 254 and further recording is not possible. <ul style="list-style-type: none"> ➔ To continue recording, erase unnecessary tracks.

While playing

Symptom	Cause/Remedy
An MD is not played normally.	<ul style="list-style-type: none"> Repeat play is selected. <ul style="list-style-type: none"> ➔ Use the jog dial on the recorder or press P MODE/⏮ on the remote control to change back to the normal play (page 32). Playback mode is changed. <ul style="list-style-type: none"> ➔ Use the jog dial on the recorder or press P MODE/⏮ on the remote control to change back to the normal play (page 32).
An MD is not played from the first track.	<ul style="list-style-type: none"> Disc playing stopped before it came to the last track. <ul style="list-style-type: none"> ➔ Press ▶ on the recorder or press the jog lever (▶) on the remote control for 2 seconds or more to start playing. The disc information has been stored to the Personal Disc Memory. <ul style="list-style-type: none"> ➔ Erase the disc information from the Personal Disc Memory (page 68).
Playback sound skips.	<ul style="list-style-type: none"> The recorder is placed where it receives continuous vibration. <ul style="list-style-type: none"> ➔ Put the recorder on a stable place. A very short track may cause sound to skip. <ul style="list-style-type: none"> ➔ Try not to create a short track.
Sound has a lot of static.	<ul style="list-style-type: none"> Strong magnetism from a television or such device is interfering with operation. <ul style="list-style-type: none"> ➔ Move the recorder away from the source of strong magnetism.

Symptom	Cause/Remedy
The volume of the recorded track is low.	<ul style="list-style-type: none"> • The track was recorded in analog mode (in digital mode, the recording level is automatically set to the same level as that of the sound source). Or you used a connecting cord with an attenuator. <ul style="list-style-type: none"> ➔ Use a correct connecting cord without an attenuator. • The recording level was low. <ul style="list-style-type: none"> ➔ Adjust the recording level manually while recording (page 31).
Volume cannot be turned up.	<ul style="list-style-type: none"> • AVLS is on. <ul style="list-style-type: none"> ➔ Release AVLS settings (page 64). • The “CUSTOM1” or “CUSTOM2” on “SOUND” settings are being applied. <ul style="list-style-type: none"> ➔ This is not malfunction. When either of these settings is applied, the maximum volume setting will be limited to a certain level (“VOL 24”) to prevent excessive loudness.
No sound comes through the headphones/earphones.	<ul style="list-style-type: none"> • The headphones/earphones plug is not firmly connected. <ul style="list-style-type: none"> ➔ Plug in the plug of the headphones/earphones firmly to the remote control. Plug in the plug of the remote control firmly to /LINE OUT. • The plug is dirty. <ul style="list-style-type: none"> ➔ Clean the plug.
VOL + or –, Virtual Surround, or 6-Band Equalizer does not function or noise is heard.	<ul style="list-style-type: none"> • The “AUDIO OUT” parameter is set to “LINE OUT”. <ul style="list-style-type: none"> ➔ Set to “HeadPhone”.
The volume from connected speaker or amplifier is low (when analog connection)	<ul style="list-style-type: none"> • The “AUDIO OUT” parameter is set to “HeadPhone”. <ul style="list-style-type: none"> ➔ Set to “LINE OUT”.
The volume from the headphones/earphones is too loud.	<ul style="list-style-type: none"> • The “AUDIO OUT” parameter is set to “LINE OUT”. <ul style="list-style-type: none"> ➔ Set to “HeadPhone”.
The recorder skips several tracks ahead or behind whenever you try to fast forward or rewind on the recorder.	<ul style="list-style-type: none"> • The group skip is on. <ul style="list-style-type: none"> ➔ The recorder returns to normal if no operation is made for 5 seconds.
The edited tracks may exhibit sound dropout during search operations.	<ul style="list-style-type: none"> • This occurs due to the MiniDisc system limitation. The fragmentation of data may cause sound dropout while searching because the tracks are played in higher speed than normal playback.

Symptom	Cause/Remedy
There is no R-channel sound output when playing a track recorded from a cassette deck or through an amplifier, or when listening to sound from a cassette deck or amplifier.	<ul style="list-style-type: none"> • There is no R-channel output if the cassette deck or an amplifier is connected with a monaural cord. <ul style="list-style-type: none"> ➔ Make sure to use a stereo connecting cord. If, however, the connected equipment is monaural, there will be no R-channel sound output even with a stereo connecting cord.

While Editing

Symptom	Cause/Remedy
The lid does not open.	<ul style="list-style-type: none"> • The power sources have been disconnected during recording or editing, or the battery have been exhausted. <ul style="list-style-type: none"> ➔ Set the power sources again, or replace the exhausted battery with new ones.
Editing cannot be done.	<ul style="list-style-type: none"> • The power source has been disconnected or a power outage has occurred during editing. <ul style="list-style-type: none"> ➔ The editing done to that point is not saved to the disc. Do the editing operation again.
You cannot erase a track checked out from your computer.	<ul style="list-style-type: none"> • This is due to the MiniDisc system limitations. To erase a track that has been checked out from your computer, check it back in first, and then erase it using the SonicStage software.
Track marks cannot be erased.	<ul style="list-style-type: none"> • This is due to the MiniDisc system limitations. When the data of a track is fragmented, the track mark of a fragment under 12 seconds long (in SP stereo), 24 seconds long (in LP2 stereo mode or monaural mode), or 48 seconds long (in LP4 stereo mode) cannot be erased. You cannot combine tracks recorded in different recording modes, e.g., a track recorded in stereo and a track recorded in monaural; nor can you combine a track recorded with digital connection and a track recorded with analog connection.
The disc cannot edit on other component.	<ul style="list-style-type: none"> • The component does not support MDLP. <ul style="list-style-type: none"> ➔ Edit on other component that support MDLP.

While using group function

Symptom	Cause/Remedy
The group function does not operate.	<ul style="list-style-type: none">• While using a disc without group setting, an attempt was made to select some group-related menu. ➔ Use a disc with group setting.
A track cannot be recorded to a new group. A new group cannot be created.	<ul style="list-style-type: none">• This is due to the MiniDisc system limitations. Group information has been written to the area where the disc name is stored. The disc name and track names are recorded in the same area, which can store a maximum of approximately 1,700 characters. If the total number exceeds this amount, a new group cannot be created even though group mode is on. It is also impossible to make group settings at this time.

Others



Symptom	Cause/Remedy
The recorder does not work or works poorly.	<ul style="list-style-type: none">• The rechargeable battery is not charged. ➔ Charge the rechargeable battery.• The volume is low. ➔ Turn up the volume.• No disc is inserted. ➔ Insert a recorded disc.• The HOLD function is turned on (“HOLD” appears in the display when you press an operation button on the recorder). ➔ On the recorder, disable HOLD by sliding the HOLD switch to the opposite direction of the arrow (pages 12, 17).• The lid is not firmly closed. ➔ Close the lid until it clicks. Then slide OPEN to open the lid.• Moisture has condensed inside the recorder. ➔ Take the MD out and leave the recorder in a warm place for several hours until the moisture evaporates.• The AC power adaptor is not firmly connected. ➔ Connect the AC power adaptor firmly to the DC IN 3V jack on the recorder or the battery charging stand and to the house current.• The rechargeable battery or dry battery is weak (“LOW BATT” flashes or nothing appears). ➔ Charge the rechargeable battery or replace the dry battery with a new one (page 16), or use the supplied AC power adaptor.• The dry battery have been inserted incorrectly. ➔ Insert the battery correctly (page 17).





Symptom	Cause/Remedy
The recorder does not work or works poorly.	<ul style="list-style-type: none"> • The disc is damaged or does not contain proper recording or editing data. ➔ Reinsert the disc. Rerecord the disc. If the error message still appears, replace it with another disc. • There is an internal malfunction in the system. ➔ Remove the dedicated USB cable from the recorder, restart your computer, and then connect the cable to the recorder again. • While operating, the recorder received a mechanical shock, too much static, abnormal power voltage caused by lightning, etc. ➔ Restart the operation as follows. <ol style="list-style-type: none"> 1 Disconnect all the power sources. 2 Leave the recorder for about 30 seconds. 3 Connect the power source.
The clock does not work correctly, the clock does not appear, or time and date stamping did not occur when recording.	<ul style="list-style-type: none"> • The recorder was disconnected from the power source for 3 minutes or more, causing the clock to return to its factory setting. ➔ Charge the rechargeable battery, and then set the clock again. • The clock is not set. ➔ Set the clock (page 58). • Time and date will not be stamped on tracks which are checked out from a computer.
During playback, the display on the remote control does not turn on.	<ul style="list-style-type: none"> • Power save mode is activated. ➔ In power save mode, the display on the remote control turns on whenever the remote control is operated, but not when the controls on the recorder are operated. (The exception is when the GROUP button on the recorder is pressed.)
The display window is not normal.	<ul style="list-style-type: none"> • The recorder was disconnected from the power source. ➔ Let the recorder sit for a while, or disconnect the power source, reconnect it, and then press any of the operation buttons.
When using with the AC power adaptor, the display window of the recorder will remain faintly lit for some time even after the recorder is stopped.	<ul style="list-style-type: none"> • This is due to the MiniDisc system limitation. The recorder turns off 3 minutes after the recorder has stopped in order to allow the charging time on the dedicated USB cradle to be calculated.
The playing time of a checked-out track is different from the time that appears on your computer monitor.	<p>This is due to a calculation discrepancy between the recorder and the computer.</p>







Messages

If the following error messages flash in the display window, check the chart below.

Error message	Meaning/Remedy
🔒 FULL	<ul style="list-style-type: none">You tried to set a 21st bookmark. ➡ You can set only up to 20 bookmarks. Keep the number of bookmarks within 20.
AVLS	<ul style="list-style-type: none">AVLS is set to "AVLS ON" and so the volume cannot rise higher. ➡ Set AVLS to "AVLS OFF" (page 64).
BLANKDISC	<ul style="list-style-type: none">An MD with no recording on it is inserted.
BUSY	<ul style="list-style-type: none">You tried to operate the recorder while it was accessing the recorded data. ➡ Wait until the message goes out (in rare cases, it may take a few minutes).
CannotCHG	<ul style="list-style-type: none">You tried to charge the battery at a place with a temperature outside the specified range for the recorder. ➡ Charge the battery at a temperature of +5°C (+41°F) to +40°C (+104°F).
Charging	<ul style="list-style-type: none">The rechargeable battery is being charged.
DISC FULL	<ul style="list-style-type: none">The remaining recording time on the disc is 12 seconds (SP stereo), 24 seconds (LP2 stereo or monaural), 36 seconds (LP4 stereo), or less. ➡ Replace the disc.
ERROR	<ul style="list-style-type: none">There is an internal malfunction in the system. ➡ Restart the operation by doing steps 1 to 3 on page 84. If the message appears again, please consult your nearest Sony dealer.
GroupFULL	<ul style="list-style-type: none">You tried to create a 100th group. ➡ You can create only up to 99 groups on a disc. Keep the group number within 99.
Hi DC in	<ul style="list-style-type: none">Voltage of the power supply is too high (The supplied AC power adaptor or the recommended car battery cord is not used). ➡ Use the supplied AC power adaptor or the recommended car battery cord.
HOLD	<ul style="list-style-type: none">The recorder is locked. ➡ Slide HOLD against the arrow to unlock the recorder (page 17).
LINE OUT	<ul style="list-style-type: none">You pressed VOL+, – while the "AUDIO OUT" parameter was set to "LINE OUT". ➡ Use the jog dial to set the "AUDIO OUT" parameter to "HeadPhone".

Error message	Meaning/Remedy
LOW BATT	<ul style="list-style-type: none"> • Batteries are weak. ➔ Charge the rechargeable battery or replace the dry battery (page 16).
MEM OVER	<ul style="list-style-type: none"> • You tried to record with the recorder placed where it receives continuous vibration. ➔ Put the recorder on a stable place, and start recording again.
MENU	<ul style="list-style-type: none"> • You pressed a key on the remote control while selecting a menu on the recorder. • You pressed a key on the recorder while selecting a menu on the remote control.
NAME FULL	<ul style="list-style-type: none"> • You tried to enter more than 200 letters to label a single track, group, or disc. • You tried to enter a total of more than approximately 1,700 letters for track or disc names.
NO COPY	<ul style="list-style-type: none"> • You tried to make a copy from a disc that is protected by the Serial Copy Management System. You cannot make copies from a digitally connected source which was itself recorded using digital connection. ➔ Use analog connection instead (page 28).
NO DISC	<ul style="list-style-type: none"> • You tried to play or record with no disc in the recorder. ➔ Insert an MD.
NO EDIT	<ul style="list-style-type: none"> • You selected “: Erase” with a disc without group setting. ➔ You cannot erase groups with a disc with no groups. • You selected, “: Set”, “: Release”, “Move”, or “Erase” while recording. • You tried to erase the track mark at the beginning of the first track or group. • You tried to erase a track mark to combine tracks the recorder cannot combine (a track recorded in stereo and in mono, for example). • You tried to overwrite a track marks.
No Entry!	<ul style="list-style-type: none"> • You tried to erase a setting in the Personal Disc Memory on a disc that contains no settings in the Personal Disc Memory (page 68).
No MARK	<ul style="list-style-type: none"> • You selected bookmark play without setting bookmarks. ➔ Set bookmarks (page 33).

Error message	Meaning/Remedy
NO SET	<ul style="list-style-type: none"> • You tried to set Digital Pitch Control while the “AUDIO OUT” parameter was set to “LINE OUT”. ➔ Use the jog dial to set the “AUDIO OUT” parameter to “HeadPhone”. • You tried to make the following settings while recording. <ul style="list-style-type: none"> — Personal Disc Memory — Melody Timer — Digital Pitch Control — Recording mode — Recording level — Selection of “: REC” in menu — Selection of “REC-Posi” during recording to a group.
NoOPERATE	<ul style="list-style-type: none"> • You pressed  + or – while programming a track using the remote control. • You tried to make the Auto Time Mark setting while recording through digital connection. • You tried to press  or T MARK during synchro-recording.
NO SIGNAL	<ul style="list-style-type: none"> • The recorder could not detect digital input signals. ➔ Make sure that the source is connected firmly (page 20).
P/B ONLY	<ul style="list-style-type: none"> • You tried to record or edit on a pre mastered MD (P/B stands for “playback”). ➔ Insert a recordable MD.
PROTECTED	<ul style="list-style-type: none"> • You tried to record or edit on a MD with the tab in the record-protect position. ➔ Slide the tab back (page 74).
Push STOP	<ul style="list-style-type: none"> • You tried to open the lid while the recorder was storing disc information. ➔ Open the lid only after pressing  and “TOC Edit” has disappeared from the display.
READ ERR	<ul style="list-style-type: none"> • The recorder cannot read the disc information correctly. ➔ Reinsert the disc.
REC ERR	<ul style="list-style-type: none"> • Recording was not correctly done. ➔ Place the recorder at a place with no vibrations and record again. • The disc is soiled with an oil film or finger prints, is scratched, or is not a standard disc. ➔ Try recording again with another disc.
Rehearsal	<ul style="list-style-type: none"> • You tried to operate a button and or a lever (other than the control) on the remote control while the recorder is performing rehearsal play during a track division operation.

Error message	Meaning/Remedy
SEL Group	<ul style="list-style-type: none"> • You selected “ : Name”, “ : Move”, or “ : Erase” while the recorder is stopped or while playing a track that does not belong to a group. ➔ Select a track within a group you want to edit, and then do the editing operation again.
SEL Track	<ul style="list-style-type: none"> • You selected “ : Name”, “ : Move”, or “ : Erase” after playback has already finished or after END SEARCH was pressed, and the recorder has stopped. ➔ Do the editing operation again after selecting the desired track first.
SLOW CHG	<ul style="list-style-type: none"> • You tried to charge at a place where the temperature is too low. ➔ Charge the battery at a temperature of +5°C (+41°F) to +40°C (+104°F).
TEMP OVER	<ul style="list-style-type: none"> • Heat has built up in the recorder. ➔ Let the recorder cool down.
TOC Edit	<ul style="list-style-type: none"> • The MD player is recording information (track start and end position) from the memory to the disk. ➔ Wait until this process is completed. Do not expose the player to physical shock, nor disrupt power supply.
TOC ERR	<ul style="list-style-type: none"> • The recorder cannot read the disc information correctly. ➔ Insert another disc. ➔ If it is no problem to erase the entire disc, do so (page 44).
TR FULL	<ul style="list-style-type: none"> • Track number 254 has been reached. ➔ Erase unnecessary tracks (page 44).
TrPROTECT	<ul style="list-style-type: none"> • You tried to record or edit a track that is protected from erasing. ➔ Record or edit on other tracks. • You tried to edit a track that has been checked out from a computer. ➔ Check the track back in to the computer and then edit.

Explanations

Difference between digital (optical) and analog (line) inputs

The input jack of this recorder works as both digital and analog input jacks. Connect the recorder to a CD player or a cassette recorder using either digital (optical) input or analog (line) input. To record, see “Recording an MD right away!” (page 19) to record using digital (optical) input, and “Recording from a TV or radio (Analog Recording)” (page 28) to record using analog (line) input.

Difference	Digital (optical) input	Analog (line) input
Connectable source	Equipment with an digital (optical) output jack (CD player, DVD player, etc.)	Equipment with an analog (line) output jack (Cassette deck, radio, record player, etc.)
Usable cord	Optical cable (with an optical or an optical-mini plug) (page 20)	Line cable (with 2 phono plugs or a stereo-mini plug) (page 28)
Signal from the source	Digital	Analog Even when a digital source (such as a CD) is connected, the signal sent to the recorder is analog.
Track marks ¹⁾	Marked (copied) automatically <ul style="list-style-type: none">• at the same positions as the source (when the sound source is a CD or an MD).• after more than 2 seconds of no sound (page 90) or low-level segment (with a sound source other than a CD or an MD).• when the recorder is paused (3 seconds of no sound is encountered while synchro-recording)	Marked automatically <ul style="list-style-type: none">• after more than 2 seconds of no sound (page 90) or low-level segment.• when the recorder is paused while recording.
Recorded sound level	Same as the source. Can also be adjusted manually (Digital REC level control) (“Adjusting the recording level manually”, page 31).	Adjusted automatically. Can also be adjusted manually (“Adjusting the recording level manually”, page 31).

¹⁾ You can erase unnecessary marks after recording. (“Combining tracks (Combine)”, page 44).

Note

Track marks may be copied incorrectly:

- when you record from some CD players or multi disc players using digital (optical) input.
- when the source is in shuffle or program play mode while recording using digital (optical) input. In this case, play the source in normal play mode.
- when programs with audio that is digitally broadcast (e.g., digital TV) are recorded through the digital (optical) input.

The meaning of “no sound”

“No sound” describes a recorder condition in which the input level is about 4.8 mV during analog input or less than -89 dB during optical (digital) input (with 0 dB as full bit (the maximum recordable level for a MiniDisc)).

Note on digital recording

This recorder uses the Serial Copy Management System, which allows only first-generation digital copies to be made from premastered software. You can only make copies from a home-recorded MD by using the analog (line out) connections.

Premastered software such as CDs or MDs.

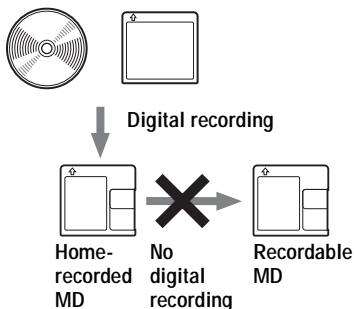

Microphone, record player, tuner, etc. (with analog output jacks).

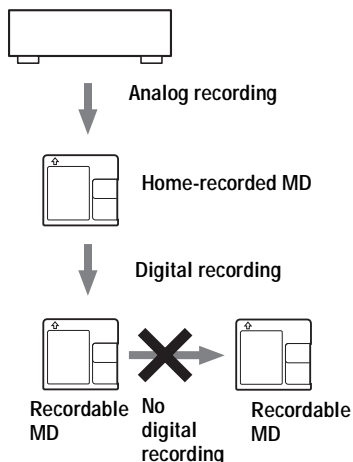

Restrictions on the editing of tracks checked out from your computer

This unit was designed so that editing functions (i.e., erasing tracks, adding track marks, and erasing track marks) do not function for tracks that have been checked out from your computer. This is to prevent the loss of check-in authorization by the checked-out tracks. To edit these tracks, first check them back into the computer, and then edit them on the computer.

About the DSP TYPE-S for ATRAC/ATRAC3

This recorder supports DSP TYPE-S, a specification for high-level Sony MiniDisc decks equipped with digital signal processors (DSP). This specification allows the recorder to produce high-quality sound from tracks recorded in MDLP mode. Since it retains DSP TYPE-R support, the recorder produces superior results during recording or playback in SP (normal stereo) mode.

Suppressing the skips of the sound (G-PROTECTION)

The G-PROTECTION function was developed to provide a higher level of shock resistance than that of existing players.

Recording audio data to your computer

You can record audio data to your computer from sources such as audio CDs and the Internet (page 100).



Audio CDs



Internet



On the computer

Listening

You can listen to an audio CD in the CD-ROM drive of your computer, or audio data in the hard disk drive (page 107).



What is a Net MD?

Net MD is a standard that enables the transfer of audio data from a computer to a MiniDisc device. To use this Net MD with your computer requires a software application called “SonicStage”.

SonicStage software provides a database for managing audio data in the computer and functions for playing the audio data in various play modes, editing the data, and transferring the results to other devices and hardware connected to the computer. It is an integrated software application with a variety of functions for enjoying music.

Transferring audio data to the Net MD

You can transfer audio data stored in your computer to an MD (page 104).

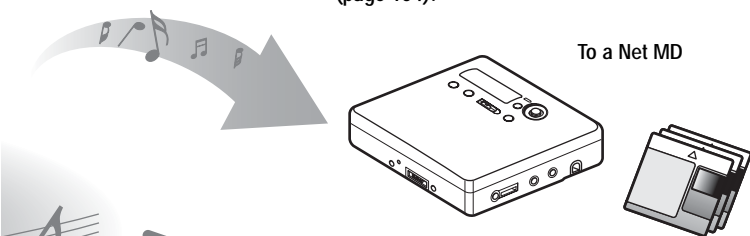

Editing

You can easily edit audio data or add labels from the keyboard (page 103).



Creating a music library

You can create a music library of your favorite songs on your computer.



Basic operational flow using the Net MD

The following is the basic steps that you will take following the purchase of your recorder. Through these steps, you will prepare and set up your computer for use of your recorder as a Net MD. Do the following steps, and refer to the indicated pages for details.

1 Providing the required system environment.

(page 95)

2 Installing the software onto your computer.

(page 96)

3 Connecting the Net MD to your computer.

(page 99)

4 Storing audio data to your computer.

In this manual, recording from an audio CD is explained.

(page 100)

5 Transferring audio data from your computer to an MD (Check-out).

(page 104)

6 Listening to an MD.

You can listen to audio data that have been checked out from your computer to your Net MD.

(page 107)

Providing the required system environment

System requirements

The following hardware and software are required in order to use the SonicStage software for the Net MD.

Computer	IBM PC/AT or Compatible
	<ul style="list-style-type: none">• CPU: Pentium II 400 MHz or higher (Pentium III 450 MHz or higher is recommended.)• Hard disk drive space¹⁾: 120 MB or more• RAM: 64 MB or higher (128 MB or higher is recommended)
	Others
	<ul style="list-style-type: none">• CD-ROM drive (capable of digital playback by WDM)• Sound Board• USB port (supports USB 2.0 Full Speed (previously USB 1.1))
Operating System	Factory installed: Windows XP Home Edition/Windows XP Professional/Windows Millennium Edition/Windows 2000 Professional/Windows 98 Second Edition
Display	High Color (16bit) or greater, 800 × 480 dots or more (800 × 600 dots or more is recommended)
Others	<ul style="list-style-type: none">• Internet access: for Web registration and EMD services• Windows Media Player (version 7.0 or higher) installed for playing WMA files

¹⁾ See page 113 for details.

This software is not supported by the following environments:

- Macintosh
- Windows XP versions other than Home Edition or Professional
- Windows 2000 versions other than Professional
- Windows 98 versions other than Second Edition
- Windows NT
- Windows 95
- Personally constructed PCs or operating systems
- An environment that is an upgrade of the original manufacturer-installed operating system
- Multi-boot environment
- Multi-monitor environment

Notes

- We do not ensure trouble-free operation on all computers that satisfy the system requirements.
- We do not ensure trouble-free operation of the system suspend, sleep, or hibernation function on all computers.

Installing the software onto your computer

This section explains the installation of the SonicStage Ver.1.5 software supplied with your Net MD.

Before installing the software

1 Make sure to note the following before installing the software.



Do not connect the dedicated USB cable before the installation!

The SonicStage software may not correctly load or operate if the dedicated USB cable is connected to your computer during the installation.



Close all other Windows applications before starting the installation!

Make sure to close any virus-check software, as such software usually demand large amounts of system resources.

2 Depending on the following operating system or software already installed on your computer, refer to the reference pages before installing the software.

Windows XP → page 110	<ul style="list-style-type: none">• To install this software, you must log on with a user name with “Computer Administrator”.• If you perform the “System Restore” function in the Windows “System Tools” menu, the tracks managed by SonicStage may become corrupted and rendered unplayable.
Windows Millennium Edition → page 111	<ul style="list-style-type: none">• If you perform the “System Restore” function of the Windows “System Tools” menu, the tracks managed by SonicStage may become corrupted and rendered unplayable.
Windows 2000 → page 111	<ul style="list-style-type: none">• You must log on as “Administrator” before installing the software.
OpenMG Jukebox, SonicStage, or SonicStage Premium → page 112	<ul style="list-style-type: none">• Depending on the version of your software, the existing software may be overwritten by the new version or it may co-exist with SonicStage Ver.1.5. As the installation process will depend on the version, see the reference page for details.

Installing SonicStage Ver.1.5

1 Turn on your computer and start up Windows.

2 Insert the installation CD-ROM for SonicStage into the CD-ROM drive of your computer.

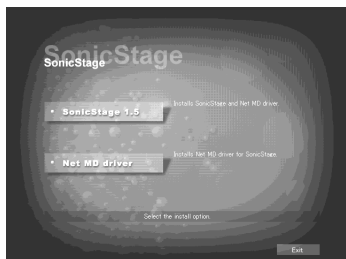

The setup program starts up automatically and the SonicStage Ver.1.5 installation window appears.

3 Click to select [SonicStage 1.5].

To use this software with the Net MD, you must install SonicStage Ver.1.5 and the Net MD driver.

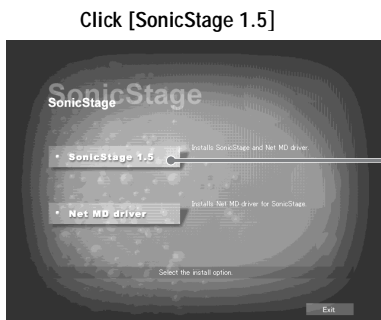

- When installing SonicStage for the first time
- When SonicStage, SonicStage Premium, or OpenMG Jukebox is installed on the computer

4 Follow the displayed instructions.

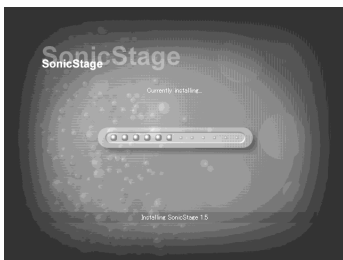

Read the instructions carefully. The installation may take 20 to 30 minutes, depending on your system environment (page 119).

5 After the installation is completed, click [Restart] to restart the computer.

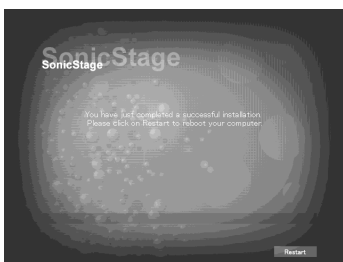

Make sure to restart your computer only after the installation has completed.

Was the installation successful?

If any trouble occurs during the installation, see “Troubleshooting” (page 116).

Notes

- Do not delete, move, or edit any of the installed folders using Explorer or any other application. Doing so could cause the SonicStage database to become unstable or corrupted.
- While the installation is still in progress, do not interrupt the operation or take the CD-ROM out of the CD-ROM drive. Doing so may render it impossible to install the software thereafter.

Connecting the Net MD to your computer

After the software installation is completed, connect the Net MD to your computer. Refer to the operating instructions of the Net MD as well.

- 1 Insert a recordable disc into the Net MD.
 - 2 Make the power source and the dedicated USB cable connections with the Net MD and the computer.
-

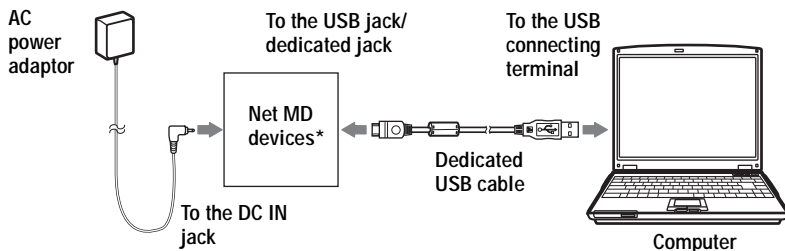

* If a cradle is supplied with your Net MD, connect the dedicated USB cable to the USB cradle and place the Net MD onto the USB cradle.

- 3 Check the connections.

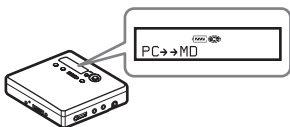

When the connections have been properly made, “PC→MD”^{*} appears in the display of the Net MD.

^{*}Depending on the device, “Net MD” may be displayed.

Notes

- When using the Net MD connected to your computer, it is recommended that you run the recorder from an AC outlet. If you use a battery to run the Net MD, be sure to use a new dry cell or a fully charged rechargeable battery. We do not assure the results should there be a mis-operation, check-out failure, or destruction of audio data caused by insufficient battery power.
- When using the Net MD with the cradle, place the cradle on a stable surface so that the dedicated USB cable does not become detached.

Storing audio data to your computer

This section explains how to record and store audio data from an audio CD to the hard disk drive of your computer.

The procedure in this section is used to record all tracks on an audio CD. To record only specific tracks from a CD, or from other sound sources, see the online help for details (page 108).

Note

The system may malfunction if your computer changes to system suspend or hibernation mode while the software is playing, recording, or connecting to an external device or media* such as a Net MD. Make sure to disable any changes to suspend or hibernation mode. See page 113 for details.

* For this software, the word “MD” refers to the built-in MD slot on the computer, and “Device/Media” to a Net MD that is externally connected over a USB cable.

Starting SonicStage

Do one of the following:

- Double click  ([SonicStage] icon) on the computer.
- Select [Start] - [Programs]* - [SonicStage] - [SonicStage].

* [All Programs] in the case of Windows XP

SonicStage starts up and the main window appears.

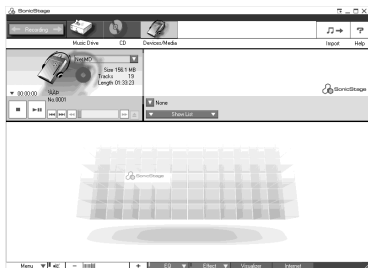

Recording audio CDs to the hard disk drive

In SonicStage Ver.1.5, the hard disk drive is called the “Music Drive”. The Music Drive manages all audio data stored by SonicStage.

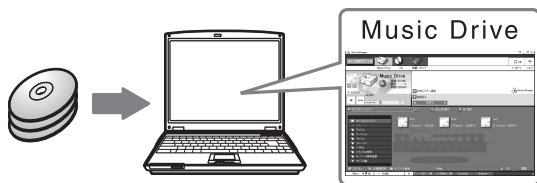

-
- 1 Insert the audio CD that you want to record into the CD-ROM drive of your computer.



The CD window appears in the display.

Note

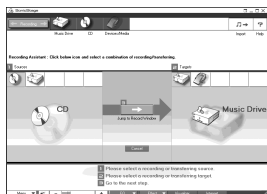

When you record an audio CD from your CD-ROM drive for the first time, the “CD Drive Optimization” dialog box appears when you insert the audio CD. Clicking [Start] initiates a check of the CD-ROM drive to verify that the CD-ROM drive is able to perform the recording properly.

-
- 2 Click .



The recording navigation window* appears in the display.

*The recording navigation window makes it easy to make a recording. Simply by doing **1**, **2** and **3** in the next step, you can select the audio source in the left panel and the recording destination in the right panel.

-
- 3 Select  (CD) for [**1** Sources] and  (Music Drive) for [**2** Targets], then click **3**  [Jump to Record Window].

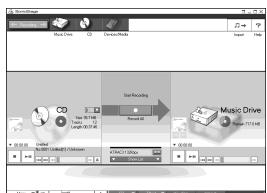

The display changes to the recording window.

-
- 4 Click **ATRAC3 132kbps**  in the middle of the recording window and select the recording mode.

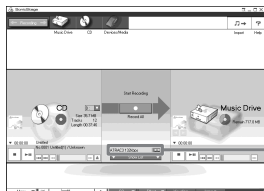

When recording data in LP2 mode:
select ATRAC3 132kbps
When recording data in LP4 mode:
select ATRAC3 66kbps

-
- 5 If the list panel is not displayed, click .



List panels appear under the recording window. The contents of the audio CD appear in the left list panel.

-
- 6 Click  [Record All].

Recording starts.

Upon completion, recorded tracks appear in the right list panel.

To stop recording

Click  ([Stop]).

To resume recording, click . When recording is resumed, it starts from the beginning of the track that was last stopped.

Labeling audio data

After recording has completed, you can label the audio data in the Music Drive. Once audio data in the Music Drive is labeled, the label information will be transferred to a disc along with the audio data, allowing you to view the data on your Net MD.

- 1 Start up SonicStage (page 100) and click  (Music Drive).



“All Playlists” appears and all the albums stored on the Music Drive appear in the Music Drive window.

- 2 Double click the desired album name.

A list of the audio files in that album appears.

- 3 Click  in the lower right part of the display.



The editing panel appears in the display.

- 4 Select an item by clicking [Title], [Album], [Artist], or [Genre], and then right-click and select [Rename].

You can also click [▼] at [Album] or [Artist] to display a dropdown list, and then select an item from the list.

- 5 When the track title is highlighted, enter the text data from the keyboard.
-



You can also import names from a database with the  ([CD Info]) button for use in labeling tracks or albums. See the online help for details (page 108).

Transferring audio data from your computer to the Net MD (Check-out)

Audio data stored on the Music Drive can be transferred to your Net MD. This process is called “Check-out”. The number of times a track can be checked out is restricted in this software for the protection of copyrights (page 122).







Checking out audio files to the Net MD

This section explains how to check out all audio files in a playlist*.

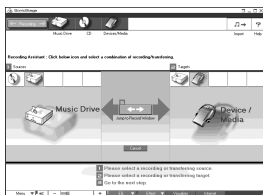
* A playlist is a container that allows the stored audio files in the Music Drive to be classified by genre, artist, etc.

-
- 1 Click  to display the recording navigation window.



-
- 2 Select  (Music Drive) for [1 Sources] and  (Device/Media) for [2 Targets], then click  ([Jump to Record Window]).
The display changes to the recording window.
-

-
- 3 Click **Normal**  in the middle of the display and select the recording mode (page 102).

Standard transfer mode: Data are transferred in the format of the original files.

Maximum available transfer space: All data are transferred in LP4 mode.

SP transfer mode: All data are converted and transferred in normal stereo mode. Select this mode if you listen to checked-out data on equipment that does not support MDLP mode.

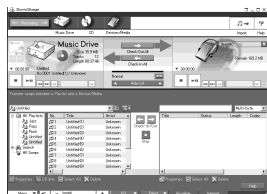

-
- 4 If the list panel is not displayed, click **Show List** .

A playlist appears in the display.



-
- 5 Confirm that the audio files you are about to check out are okay for checking out.



The music notations beside the track number in the left panel of the list represent the number of times the file can be checked out (e.g.  = the track can be checked out three more times). If  appears beside the track number, the file cannot be checked out.

-
- 6 Click  [Check-Out All].

Checking out of the files starts.

All files in the playlist are checked out to the connected Net MD.

To cancel a check-out

Click  ([Stop]).

Notes

- Once a check-out (or check-in) has started, do not disconnect the dedicated USB cable or power source until the check-out operation has completed. These actions may damage the data or cause the system to malfunction.
- Make sure not to bump the Net MD after check-out has started. If you do, the contents of the recording may not be stored correctly.
- Due to the limitations of the MD system, you may not be able to record the full amount of remaining recording time.
- Due to the limitations of the MD system, a maximum of about 1,700 characters can be stored for disc name, group names and track names on the disc. Take note of this fact when checking out a large number of tracks.

Listening to an MD

You can listen to an MD on the Net MD while it is connected to your computer. When disconnected from your computer, the Net MD can be used as an ordinary MiniDisc device.

For details on Net MD operations, refer to the “Recorder Operation” section.

Listening to an MD with the Net MD connected to the computer

If you listen to an MD with the Net MD connected to the computer, be sure to listen with the Net MD itself (connecting to the headphones/earphones, speakers, etc.). The MD sound cannot be heard from headphones/earphones that are connected to the computer.

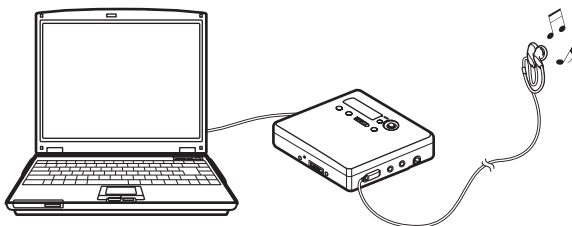

Listening to an MD with the Net MD disconnected from the computer

Listen to the MD after disconnecting the dedicated USB cable from the computer and the Net MD.

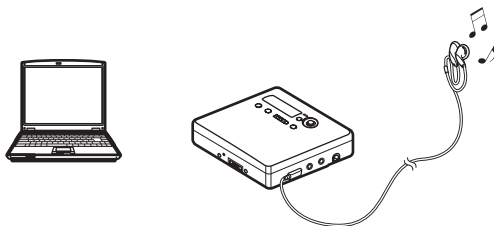

Notes

Generally, you cannot erase or divide/combine checked-out audio files. If you want to edit such files, check them back in first. Checked-out files can be edited on some MD devices; however, erasing a track will decrease the number of times the file can be checked out, and dividing or combining tracks will render the file impossible to check back into the computer (page 120).

Using other functions!

Using the SonicStage online help

This manual explains only the basic operations of the SonicStage software. However, the software has a host of other functions that allow you to carry out various operations, such as importing audio files from the Internet, classifying and managing audio files, and playing in various play modes. For information and details on the various menus and operations, go to the online help.

To display online help



Click  (help) while the SonicStage software is running.



You can display the online help by selecting the following:
[Start]–[Programs]*–[SonicStage]–[SonicStage Help]

* [All Programs] in the case of Windows XP.

Viewing online help

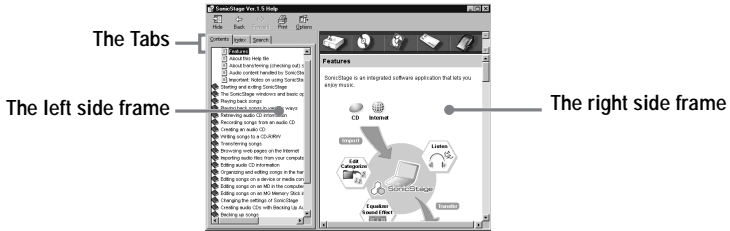

Let's find out how to use the online help first. An explanation on the use of the online help can also be found in the online help.

1 Double click [Overview] in the left-hand frame.

2 Click [About this Help file].

The explanation will appear in the right-hand frame.

3 Read the text.

Scroll the display if necessary.

Click underlined words to jump to their explanations.

Note

In the online help, "Device/Media" is the general term for external devices such as Net MDs, Network Walkmans (i.e., portable IC audio players or portable "Memory Stick" audio players), and MusicClips.

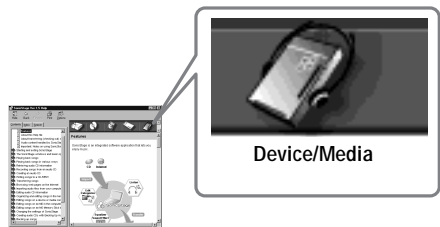

Settings and Precautions

Settings according to OS

The settings and precautions will differ according to the operating system being used. Check the items that apply to your system.

 For Windows XP users

Restrictions when running the SonicStage software under Windows XP

- To install this software, you must log on with a user name with “Computer Administrator”* as an attribute.
- You must log on with the user name “Administrators” or “Power Users” to use the SonicStage software.
- Both edition of Windows XP (Home/Professional) can be used.
- The NTFS format of Windows XP Home Edition or Windows XP Professional (factory installed) can be used only with the standard (factory) settings.

* To check whether the user name has the attribute of “Computer Administrator”
Go to [Start]- [Control Panel]-[User Account], and then check the user name displayed on the window.

When using SonicStage under Windows XP

If you use the “System Restore” function in Windows “System Tools”, audio data managed by SonicStage may become corrupted and rendered unplayable.

Before executing the system restoration procedure, you should first back up all audio files and restore them after doing the system restoration procedure.

For details about backup procedures, refer to online help.

Note

Restoring backup data requires access to the Internet. If an audio file becomes unplayable after restoring the system, an error dialog box may appear. If this occurs, do as instructed by the message.

 For Windows Millennium Edition users

When using SonicStage under Windows Millennium Edition

If you use the “System Restore” function in Windows “System Tools”, audio data managed by SonicStage may become corrupted and rendered unplayable.

Before executing the system restoration procedure, you should first back up all audio files and restore them after doing the system restoration procedure.

For details about backup procedures, refer to online help.

Note

Restoring backup data requires access to the Internet. If an audio file becomes unplayable after restoring the system, an error dialog box may appear. If this occurs, do as instructed by the message.

 For Windows 2000 users

Restrictions when running the SonicStage software under Windows 2000

- You must log on as “Administrator” to install the SonicStage software.
- You must log on with the user name “Administrators” or “Power Users” to use the SonicStage software.
- Of the Windows 2000 versions, SonicStage is supported only by Windows 2000 Professional.
- The NTFS format of Windows 2000 Professional (factory installed) can be used only with the standard (factory) settings.

 For Windows 98 Second Edition users

Importing MP3 files to the computer or playing WAV files on the computer

Microsoft Media Player version 7.0 or higher is required for importing MP3 files or playing WAV files. Users of earlier versions can download the most recent version from the Microsoft website (<http://www.microsoft.com/>).

For users with OpenMG Jukebox, SonicStage, or SonicStage Premium installed on their computer

Note

Confirm whether any tracks have been checked out from your computer. If tracks have been checked out from OpenMG Jukebox, an earlier version of SonicStage, or SonicStage Premium, it may not be possible to check those tracks back in with SonicStage Ver.1.5. It is recommended to check in the tracks before installing SonicStage Ver.1.5.

Check the following contents before installing SonicStage Ver.1.5.

The installation items and procedure will vary depending on the software installed on your computer.

Users with OpenMG Jukebox installed

Installed Version	What to do
Ver.1.0~2.1	Install SonicStage 1.5. OpenMG Jukebox Ver.1.0-2.1 is automatically uninstalled and replaced. ¹⁾
Ver.2.2	OpenMG Jukebox Ver.2.2 and SonicStage Ver.1.5 can co-exist in the computer. If you install SonicStage Ver.1.5, then OpenMG Jukebox Ver.2.2 will be automatically upgraded to the latest version.

¹⁾ Audio files recorded with OpenMG Jukebox Ver.1.0-2.1 are automatically converted to SonicStage Ver.1.5 files. For safety sake, it is recommended that you back up your audio data with the back-up tool before doing the upgrade to SonicStage Ver.1.5.

Users with an earlier version of SonicStage installed

Installed Version	What to do
Ver.1.0~1.5	Install SonicStage Ver.1.5. The earlier version is automatically uninstalled and replaced. ¹⁾

¹⁾ Audio files recorded with SonicStage Ver.1.0-1.5 are automatically converted to SonicStage Ver.1.5 files. For safety sake, it is recommended that you back up your audio data with the back-up tool before doing the upgrade to SonicStage Ver.1.5.

Users with a SonicStage Premium installed

Installed Version	What to do
SonicStage Premium	Install SonicStage Ver.1.5. SonicStage Ver.1.5 and SonicStage Premium can co-exist in the computer.

Precautions on the co-existence of SonicStage Ver. 1.5 with OpenMG Jukebox Ver.2.2 or SonicStage Premium

- Make sure the OpenMG Jukebox Ver.2.2 icon is not displayed in the task tray. If it is, the Net MD may not be recognized by your computer.
- Audio data recorded on the computer are stored in a common file and used by both applications. Therefore, if you delete an audio file (e.g., one album) in one application, it will be deleted in the other software as well.

Precaution on using a computer on which OpenMG Jukebox Ver.1.0-2.1 or SonicStage Ver.1.0-1.2 is installed

After installing SonicStage Ver.1.5, make sure you do not replace SonicStage Ver.1.5 with OpenMG Jukebox Ver.1.0-2.1 or SonicStage Ver.1.0-1.2., as all audio data in the Music Drive may be lost. If you begin the installation of OpenMG Jukebox Ver.1.0-2.1 or SonicStage Ver.1.0-1.2 by mistake, stop the installation immediately.

Note on hard disk drive space

120 MB or more free space on the hard disk drive is required. If your computer does not have enough space, the software will not be properly installed. The required free space differs according to the version of your Windows OS, or the amount of audio files that you handle.

Notes on system suspend/hibernation mode

- If the computer changes to system suspend/hibernation mode during the recording of a CD or the checking in/out of a data file, the audio data may be lost or the computer may not wake up properly. The computer suspend/hibernation function should therefore be turned off.
- If you change the media while the computer is in system suspend/hibernation mode, audio data may be lost after the computer wakes up.
- If the computer changes to system suspend/hibernation mode, the computer may not recognize the Net MD when it wakes up. If this happens, disconnect the USB cable and reconnect it again.

Backing up the audio data

Before doing any procedure that may affect the operating system itself (such as a system recovery), you should back up all of your audio data with the [SonicStage backup tool] from the [Start] - [Programs] - [SonicStage].

Uninstalling the SonicStage software

To uninstall the SonicStage software, follow the procedures below.

For Windows XP users

Log on with a user name with “Computer Administrator” as an attribute. Refer to the operating instructions of your computer for details on logging on as an administrator.

-
- 1 Click [Start]–[Control Panel].
The “Control Panel” window appears.

 - 2 Double-click [Add/Remove Programs].
The “Add/Remove Programs” dialog box appears.

 - 3 Click [Change or Remove Programs].

 - 4 Click [SonicStage 1.5.XX] in the “Currently Installed Programs” list, and then click [Change and Remove].

 - 5 Click [OpenMG Secure Module 3.1]* in the “Currently Installed Programs” list, and then click [Change and Remove].
Do as instructed by the message and restart the computer. When the computer restarts, the uninstallation will be completed.

* If SonicStage Ver.1.5 is co-existing with OpenMG Jukebox Ver.2.2 or SonicStage Premium on your computer, and you uninstall one or the other, make sure [OpenMG Secure Module 3.1] is not uninstalled since it is commonly used with both software applications.

For Windows Millennium Edition/Windows 98 Second Edition users

-
- 1 Click [Start]–[Settings]–[Control Panel].
The “Control Panel” window appears.
-

2 Double-click [Add/Remove Programs].

The Add/Remove Programs Properties window appears.

3 Click [SonicStage 1.5.XX] in the list of programs for automatic removal, and then click [Add/Remove].

4 Click [OpenMG Secure Module 3.1]* in the list of programs for automatic removal, and then click [Add/Remove].

Do as instructed by the message and restart the computer. When the computer restarts, the uninstallation will be completed.

For Windows 2000 users

Log on as “Administrator”, and then follow the instructions below.

Refer to the operating instructions of your computer for details on logging on as an administrator.

1 Click [Start]–[Settings]–[Control Panel].

The “Control Panel” window appears.

2 Double-click [Add/Remove Programs].

The “Add/Remove Programs” dialog box appears.

3 Click [Change or Remove Programs].

4 Click [SonicStage 1.5.XX] in the “Currently Installed Programs” list, and then click [Change/Remove].

5 Click [OpenMG Secure Module 3.1]* in the “Currently Installed Programs” list, and then click [Change/Remove].

Do as instructed by the message and restart the computer. When the computer restarts, the uninstallation will be completed.

* If SonicStage Ver.1.5 is co-existing with OpenMG Jukebox Ver.2.2 or SonicStage Premium on your computer, and you uninstall one or the other, make sure [OpenMG Secure Module 3.1] is not uninstalled since it is commonly used with both software applications.

Troubleshooting

Please do the following steps if you encounter a problem while using the SonicStage software. In case a message appears, it is recommended that you write it down.

Step 1: Check the symptoms in this “Troubleshooting” section.

A variety of information can also be found in the operating procedures and “Settings and Precautions” (page 110) as well.

Step 2: Check the symptoms in the SonicStage 1.5 online help (page 108).

Check “Troubleshooting” under “Additional information” in the online help. Useful information may also be found in other sections in the online help.

Step 3: If the trouble cannot be solved after checking the above references.

Check the following table and then consult your nearest Sony dealer.

Computer <ul style="list-style-type: none"> • Manufacturer: • Model: • Type: Desktop type / Laptop type
Name of operating system:
RAM capacity:
Hard disk drive (containing SonicStage and audio data) <ul style="list-style-type: none"> • Capacity of the drive: • Free space:
Installed folder containing SonicStage (if other than the default folder)¹⁾ <ul style="list-style-type: none"> • Location of the installed folder:
Version of the software (SonicStage Ver.1.5) ²⁾ :
Error Message (if one appear):
If an externally connected CD-ROM drive is used <ul style="list-style-type: none"> • Manufacturer: • Model: • Type: CD-ROM / CD-R/RW / DVD-ROM / Other () • Type of connection to the computer: PC card / USB / IEEE1394 / Other ()
If another device with USB connection is used <ul style="list-style-type: none"> • Name of the device (or devices):

¹⁾ If you do not specify the destination, the software is installed at C:\Program Files\Sony\SonicStage.

²⁾ To check the SonicStage software version, go to [Menu] - [About SonicStage] in the SonicStage window, or see the version information on the supplied CD-ROM.

If your computer does not recognize the Net MD

- **Is the Net MD connected correctly to your computer?**

- If the Net MD is not firmly connected to the computer, the Net MD will not be recognized by your computer.
- Reconnect the dedicated USB cable. If the computer still does not recognize the Net MD, disconnect the Net MD, restart the computer, and connect the dedicated USB cable again.

- **Is an MD inserted in the Net MD?**

Check if an MD is inserted in the Net MD.

- **If your computer does not recognize your Net MD even when the Net MD is connected and a disc is inserted, the Net MD driver may not be correctly installed.**

Go to the [USB Controller] in the Windows Device Manager window to verify that your Net MD is correctly recognized.

A [!] mark in the Device Manager window indicates that your Net MD is not correctly recognized. Reinstall the Net MD driver.

1 Click [Start]–[Settings]–[Control Panel].¹⁾

2 Double click [System] in the control panel.²⁾

3 Click the [Hardware]³⁾ tab, and then click [Device Manager].

The Device Manager window appears.

¹⁾ In Windows XP, select [Start]–[Control Panel].

²⁾ In Windows XP, double click [System] if the control panel is in the “classic” format, or click [Performance and Maintenance] and then [System] if the control panel is in the “category” format.

³⁾ Depending on your system, the [Hardware] tab may not be provided. In this case, click the [Device Manager] tab to display the Device Manager window.

If the installation was not successful

- **Be sure to close all Windows applications before you start the installation.**

If you start the installation while other programs are running, a malfunction may occur. This is especially true for programs that require large amounts of system resources, such as virus-check software.

- **Be sure not to connect the Net MD to your computer before you start the installation.**

If the dedicated USB cable is connected to your computer before the installation, the installation cannot be done correctly. Connect the dedicated USB cable after the installation completed.

- **Make sure your computer has enough hard disk drive space.**

120MB of free space or more on the hard disk drive is required. If your computer does not have enough space, the installation may not be possible.

- **If the installation seems to be stopped**

It may take 30 minutes or more for the installation to complete, depending on your computer or CD-ROM drive.

During the installation, watch out for the occurrence of any of the following problems.

Problem	Cause/Remedy
The installation appears to have stopped before it has completed.	Check for the appearance of an error message beneath the installation window. → Press the [Tab] key while holding down the [Alt] key. If an error message has appeared, press the [Enter] key. The installation will resume. If there is no message, the installation is still in progress. Wait a little while longer.
The progress bar on the display is not moving. The access lamp has not lit for a few minutes.	The installation is progressing normally. Please wait.

- **If the installation is still unsuccessful after all that you have done.**

— The installation can be done by copying all files to the hard disk as follows:

- 1 Create a new folder on the hard disc.
- 2 Insert the supplied CD-ROM (SonicStage Ver.1.5) into the CD-ROM drive.
- 3 When the installation window appears, click [Exit] to cancel the installation.
- 4 Right-click the start menu and start up Explorer.
- 5 Select [SS15E] on the CD-ROM drive, and then click [Edit] -[Select All].
- 6 Click [Edit]-[Copy to Folder] (or [Edit]-[Copy]) to copy all files to the folder that you created in step 1.
- 7 Remove the CD-ROM from the CD-ROM drive, open the folder that was copied to the hard disk and double-click [setup.exe].
- 8 When the installation window appears, follow the displayed instructions to install [SonicStage 1.5].

— The installation may be done by installing the software from [Start]-[Run].

Information and explanations

Net MD FAQ

This section introduces frequently asked questions and answers on the Net MD.

On the Net MD

What is a “Net MD”?

Net MD is a specification that allows audio data in a computer to be transferred to a MiniDisc through a USB cable.

Till now, MiniDiscs could be used to record only analog sources (through a microphone or analog input) or PCM sources such as CDs. Recording audio files on a computer was impossible. However, thanks to SonicStage and other music management software based on such copyright protection technology as “OpenMG”¹⁾ and “MagicGate”²⁾, conversion of audio files to the ATRAC or ATRAC3³⁾ format used on MDs became possible, enabling the recording of computer files to MDs.

- 1) Copyright protection technology for managing audio data recorded on computers, etc.
- 2) Technology for verifying the copyright-protection status of audio data in check-out/check-in operations between a computer and a Net MD device.
- 3) File type for recording to an MD.

How does the SonicStage software make using MDs more convenient?

- It allows you to record audio data from your computer to your MD.
- Editing operations are easily done using on-screen operations.
 - Labeling: Allows use of keyboard for easy labeling of contents.
 - Moving tracks or groups: Allows tracks or groups to be moved simply by dragging and dropping. Track movements are easy to see.
 - Group settings: Groups are easy to create or release.

These operations can be used to edit tracks on a disc in the Net MD. If you want to edit the contents of an MD, connect the Net MD to your computer, and edit the tracks in the SonicStage Device/Media window.

Can tracks recorded on the Net MD be checked in to a computer?

No, they cannot.

Audio data that was originally checked out from a computer can only be checked back into the same computer. Tracks that are recorded on the Net MD using a microphone or through an analog or digital connection cannot be transferred to the computer or copied.

Computer ⇔ MiniDisc : OK.

MiniDisc ⇔ Computer : OK only for tracks originally checked out from the computer.

On Editing

Can checked-out tracks be edited on the Net MD?

- Things you can do on the Net MD:
 - Label contents.
 - Assign or release groups
 - Move tracks or groups.
- Things you cannot do on the Net MD:
 - Add track marks (divide)/erase track marks (combine).
 - Delete tracks, groups, or the entire disc contents.

On copyright protection

The OpenMG technology* allows you to enjoy digital music, while maintaining the copyrights of its holders. OpenMG Jukebox encrypts audio files in OpenMG format and stores them on the hard disk of your computer to prevent unauthorized distribution.

* The copyright protection technology of this software conforms to SDMI (Secure Digital Music Initiative) specifications.

This software places some restrictions on recording and playback to protect copyrights.

You can check in audio files only to the same computer from which they were checked out. They cannot be copied or checked in to other computers.

For details, see “Features by copyright protection by OpenMG” (page 123).

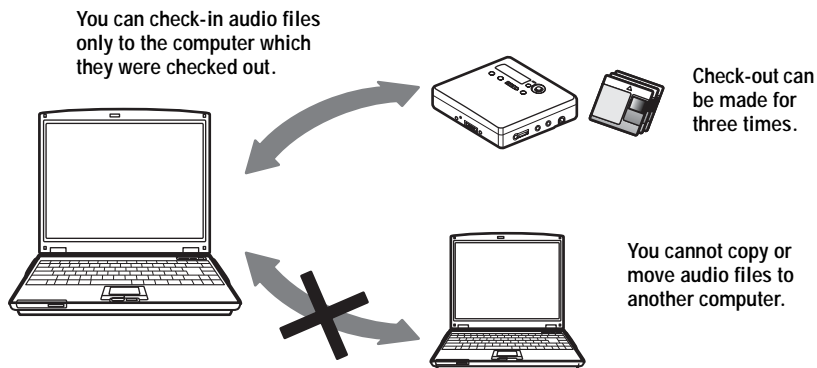

Restrictions on audio content

High-quality digital audio content is widely available through music distribution services on the Internet. To protect the copyrights of its holders from unauthorized distribution, some audio content is distributed with certain restrictions on recording and playback. For example, the playback period or playback count for the data may be limited. In such cases, checking out of the audio contents may not be possible.

Depending on the contents, some audio data that could be checked out are subject to editing restrictions on the Net MD; e.g., audio contents cannot be erased or track marks cannot be added or erased.

It is not possible to check in tracks other than those that were checked out from your computer (for example, tracks recorded using a microphone or through analog or digital connection).

Features by copyright protection by OpenMG

The SonicStage software features OpenMG, a copyright protection technology developed by Sony to protect music copyrights. OpenMG uses high-level cryptographic technology to protect music contents with computers.

Users should be aware of the restrictions described below.

- Music recorded on the hard disk using the SonicStage software cannot be played when copied to other computers.
- Installation of the same SonicStage software to other computers is not permitted.
- Usage Rules
If Usage Rules are included in the music by way of the copyright holder or the distributor, operation will be restricted to use permitted by the Usage Rule. For music, such as compact discs, that does not contain a Usage Rule, the Default Usage Rule of SDMI will apply. This Default Usage Rule states that one file can be checked out up to three times only.
- On music contents that are not compatible with the SonicStage software
Under the supervision of SDMI, this software prohibits recording of music with a copy prohibition signal.
- Upgrading SonicStage software
This software was developed in accordance with the current arrangement between Sony and SDMI. If this arrangement is modified in the future, some of the software functions may become unavailable. Sony may offer an upgrade kit in this case at additional user expense.

Glossary

ATRAC3

ATRAC3, which stands for Adaptive Transform Acoustic Coding³, is audio compression technology that satisfies the demand for high sound quality and high compression rates. The ATRAC3 compression rate is approximately 10 times higher than that of the Audio CD, resulting in an increased data capacity for the media.

“Check-In /Check-Out”

Check-out is to transfer music files from a personal computer to an external device/media (such as a Network Walkman). Returning checked-out music files to the same computer is to check in. (You cannot move checked-out music files to another computer.)

You can check out a music file, check it back in, and then check it out again an infinite number of times. The SDMI rules provide that up to four copies of a music file can be checked out at one time. OpenMG employs a method whereby three copies of a song can be checked out simultaneously, while the fourth copy is maintained as a master on your PC.

Electronic Music Distribution (EMD) service

EMD is a website that distributes music files which are available for purchase.

MP3

MP3, which stands for MPEG-1 Audio Layer³, is a standard for audio file compression determined by the Motion Picture Experts Group, an ISO (International Organization for Standardization) working group. It enables compression of audio files to about 1/10 of the data size of a standard compact disc. Since the MP3 encoding algorithm is disclosed, there are various encoders/decoders that are compliant with this standard, including freeware that is available for no charge. The MP3 standard is therefore widely used in the computer field.

Music Drive

Music Drive is a music database for managing audio data on a computer. In Music Drive, audio files can be managed along with such information as artist names, track names, and CD jacket images, or can be combined and categorized in different playlists.

OpenMG

Copyright protection technology for the import and management of musical content from distribution services or CDs. By using software that are compliant with OpenMG, audio contents can be encrypted before storage on a hard disk drive to allow playback of those audio files on that computer. OpenMG also prevents the unauthorized distribution of the contents via the Internet or other networks.

Playlist

A playlist is like a container that can be used to hold and categorize files stored in Music Drive. For example, by making a “jazz” playlist and then putting your favorite jazz tracks into the playlist, you can play all of the tracks repeatedly or check them all out at the same time.

Recording mode (Bit rate)

This is a measure of data volume per second. The rate is expressed in bps (bits per second). In SonicStage, the bit rate can be selected for recording an audio CD or converting MP3 and WAV format audio files into ATRAC3 format from among three rates: 132 kbps, 105 kbps or 66 kbps. In the case of 105 kbps, 105,000 bits of information is processed per second. If the bit rate is large, that means a large amount of information is used to play the music. Thus, 105 kbps data produces better sound quality than 66 kbps data, and 132 kbps data provides better sound quality than 105 kbps data. However, audio files in formats such as MP3 have different encoding methods, and so the sound quality is not determined by the bit rate alone.

SDMI

SDMI, which stands for Secure Digital Music Initiative, is a forum that consists of over 130 companies in the fields of recorded audio content, computers, and consumer electronics. It is dedicated to the development of integrated copyright protection technology that can be used worldwide.

SDMI is working to create a framework for preventing the improper usage of audio files and to promote legal music distribution services. The copyright protection technology OpenMG is based on the SDMI standard.

Windows Media Audio

This is an audio compression technology that includes the management system called “Windows Media Rights Manager”.

Windows Media Technology

This is a technology that includes a contents management system called Windows Media Rights Manager which encrypts contents and distributes music contents along with their conditions for usage, distribution, etc. Audio files supporting Windows Media Technologies (WMT) downloaded via EMD* can be imported into and managed by OpenMG Jukebox.

* EMD may not be available in certain areas of the world.

Index

Numerics

6-Band Equalizer 35

A

Accessories

- optional 75
- supplied 11

ATRAC3 120, 124

Audio CD 92, 101

Auto Time Mark 30

AVLS 64

B

back up 113

Backlight 65

Battery

- battery life 18
- built-in battery 16
- dry battery 17

BEEP 58

Bookmark

- add 33
- play 33

C

CD-ROM 95

Charging 16

Check-in 120, 124

Checking

- clock 58
- playing position 32
- remaining time 25, 32

Check-out 104, 120, 124

Cleaning 74

Clock 58

Combining tracks 44

Connecting 99

- analog 28
- digital 20
- when charging 16

Connection 38

Contrast 65

copyright protection 122

D

delete (software) 114

Device/Media 104, 109

Digital Pitch Control 36

Digital Sound Preset 34

Divide

- directly 43
- rehearsal 43

DSP TYPE-S 90

E

EMD services 124

Erasing

- a whole disc 45
- groups 52
- tracks 45

G

G-PROTECTION 91

Group

- erasing 52
- moving 52
- play 47
- recording 46
- releasing 50
- setting 49
- skip 47

Group Program Play 48

H

hard disk

- free space 95, 113
- storing 101

HOLD 12

I

Installing 97

L

Labeling

- a disc 40
- tracks 40

labeling 103

M

Manual recording 31

MDLP 27

Melody Timer 36

Menus 70

Move

 groups 51

 tracks 42

MP3 124

Music Drive 101, 124

N

Name

 a disc 39

 groups 50

 tracks 39

Net MD 93, 120

Net MD driver 118

O

Online help 108

OpenMG 124

OpenMG Jukebox software 96, 112

P

Personal Disc Memory 68

Play mode

 groups 47

 tracks 32

Playlist 104, 124

Program Play 34

Q

Quick mode 63

R

Recording

 adding track marks 30

 analog 28

 digital 19

 from microphone 29

 level 31

 MDLP mode 27

 without overwriting tracks 59

Recording mode (Bit rate) 102, 105, 125

Recording navigation window 101

Relabeling 41

S

SDMI 125

SonicStage Premium 96, 112

SonicStage software (earlier version) 96, 112

start (software) 100

Synchro-recording 26

System environment 95

System limitations 95

T

Track mark

 Add (Divide) 43

 Erase (Combine) 44

Transferring

 to the computer 100

 to the Net MD 104

U

Uninstalling

 Windows 2000 115

 Windows 98 Second Edition 114

 Windows Millennium Edition 114

 Windows XP 114

USB

 cable 11

 cradle 16

V

Virtual Surround 34

W

Windows 2000 115

Windows 98 Second Edition 114

Windows Millennium Edition 114

Windows XP 114

WMA 125

WMT 125



Printed on 100% recycled paper using
VOC (Volatile Organic Compound)-
free vegetable oil based ink.

<http://www.sony.net/>

Printed in Japan