



PS3 Wireless Racing Wheel

RF-GPS3009

User Guide

Rocketfish RF-GPS3009 PS3 Wireless Racing Wheel

Contents

Introduction	2
Safety	3
Features.....	3
Connecting the racing wheel.....	5
Using the racing wheel-advanced features	9
Troubleshooting	11
Legal notices	11
90-Day Limited Warranty	13

Introduction

Congratulations on your purchase of the Rocketfish RF-GPS3009 PS3 wireless racing wheel. This racing wheel represents the state of the art in wireless racing wheel design and is designed for reliable and trouble-free performance.

Safety

Caution: Some medical studies have suggested that long periods of repetitive motion may be linked to certain types of physical discomfort or injuries. You should take frequent breaks during game play. If you feel aching, numbness, or tingling in your arms, wrists, or hands, consult a qualified health professional.

- Do not use the racing wheel if you have respiratory, heart, or other physical ailments that limit your physical activity. If you have any doubts, consult with a qualified health professional.
- The racing wheel is not intended for small children. The racing wheel may contain small pieces that should be kept away from small children because they may pose a choking hazard.
- Do not disassemble any of the racing wheel components. Refer all servicing to qualified personnel only.
- Do not place or store the racing wheel in a humid area and do not expose it to water or rain.
- Use the racing wheel only as instructed. Read all instructions before operating the racing wheel.
- Failure to follow these directions may void the warranty.

Features

- Four port LED indicator
- HOME button to sync the racing wheel with the PS3 console
- Compatible with all PS3 consoles, including US, Japanese, and European versions
- Directional pad inputs: up (1), down (1), left (1), right (1), 45 degree (4)
- Analog button inputs (4)
- Digital button inputs: START, SELECT, R1, R2, L1, L2, L3, R3, and HOME
- Low voltage alert and power saving feature (sleep mode and automatic off)
- Programmable buttons: foot pedals, L3, R3, and gear stick
- Large and durable suction cups that firmly attach the racing wheel to a flat surface to make the racing wheel easy to operate
- 270 degree steering angle
- Foot pedal with springs that give you a realistic driving experience

Package contents

- Wireless racing wheel
- Foot pedals
- Receiver
- AA batteries (4)

Button layout

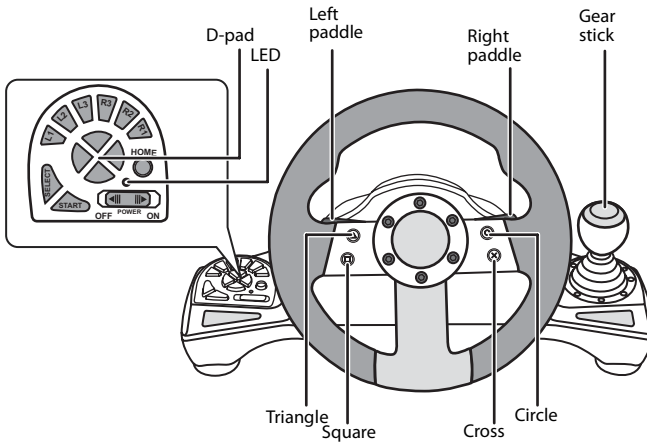

Foot pedal and receiver

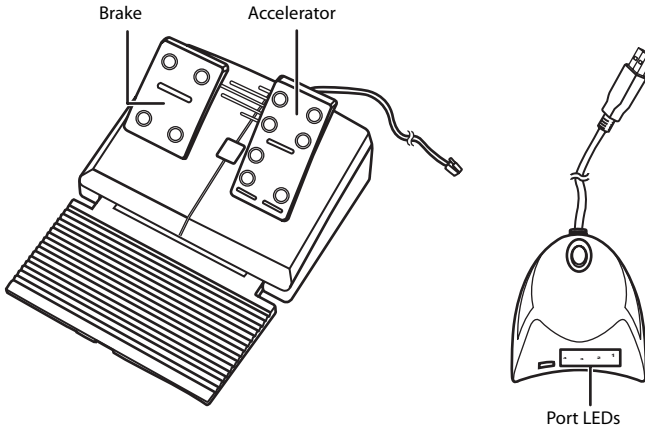

Connecting the racing wheel

To connect the racing wheel:

- 1 Plug the receiver into the USB port #1 on the PS3 console, then turn on the console.

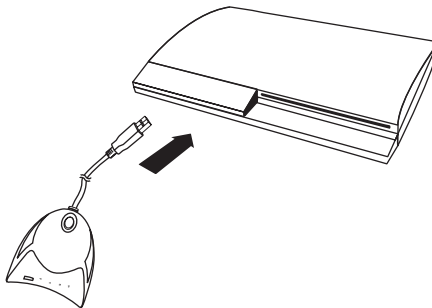

- 2 Open the battery compartment on the bottom of the racing wheel, insert four AA batteries into the compartment, then close the compartment. Make sure that the + and – symbols on the batteries match the + and – symbols in the battery compartment.

Warning: Make sure that you insert the batteries correctly. If the batteries are inserted incorrectly personal injury or damage to the racing wheel may occur.

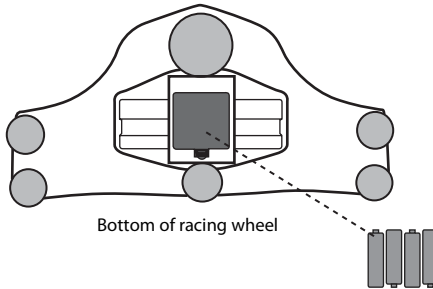

- 3 Connect the foot pedal to the racing wheel, then turn on the power switch on the racing wheel.

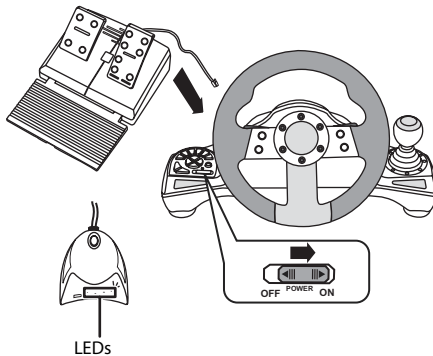

- 4 Press **HOME** to select the port the racing wheel is connected to. The corresponding LEDs light.

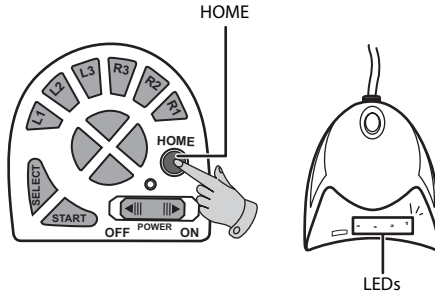

LEDs	Port
1	1
2	2
3	3
4	4
2+4	5
3+4	6

Note: If you unplug the racing wheel or restart the PS3 console, you must press **HOME** again to select the port.

Forcing a connection

If you have more than one racing wheel connected to the PS3, you may need to force a wheel to connect with the PS3.

To force a connection:

- 1 Connect the receivers to the PS3.

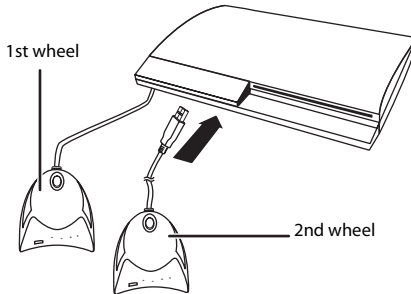

- 2 Press **SELECT** and **DOWN** on the racing wheel at the same time.

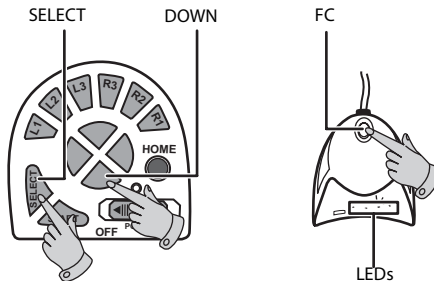

- 3 Press **FC** on the receiver. The LED on the receiver lights solid. This indicates the forced connection has been made.

Using the racing wheel-advanced features

Programming the racing wheel

To program the racing wheel:

- 1 Press and hold **SELECT** and **START** for three seconds. The LED turns on.
- 2 Press the button or move the controller for the item you want to program. The LED flashes. You can program the foot pedals, left paddle, right paddles, L3, R3, and the gear stick.
- 3 Press the source button (X, O, □, △, L1, L2, R1, or R2). The LED turns off.

Canceling a single programmed function

To cancel a single programmed function:

- 1 Press and hold **SELECT** and **START** for three seconds. The LED turns on.
- 2 Press the button for the function you want to cancel. The LED flashes.
- 3 Press the function button again. The LED turns off and the function is canceled.

Canceling all programmed functions

To cancel all programmed functions:

- 1 Press and hold **SELECT** and **START** for three seconds. The LED turns on.
- 2 Press and hold **START** until the LED turns off. All programmed functions are canceled.

Assigning foot pedals to the RY axis

To assign foot pedals to the RY axis:

- 1 Press and hold **SELECT** and **START** for three seconds. The LED turns on.
- 2 Press the foot pedal you want to assign to the RY axis. The LED turns off and the pedal is assigned to the RY axis.

Canceling the RY axis function

To cancel the RY axis function:

- 1 Press and hold **SELECT** and **START** for three seconds. The LED turns on.
- 2 Press the foot pedal assigned to the RY axis twice. The LED turns off and the RY axis function is canceled.

Adjusting the sensitivity

To adjust the sensitivity:

- 1 Press and hold **SELECT** and **START** for three seconds. The LED turns on.
- 2 Press **SELECT**. The LED indicates the current sensitivity setting.
 - LED solid—Medium sensitivity
 - LED flashing quickly—High sensitivity
 - LED flashing slowly—Low sensitivity
- 3 Press **UP** on the D-pad to save the setting.

Conserving power

The racing wheel has sleep mode and automatic off functions to conserve power.

The racing wheel enters sleep mode if it is connected to the PS3 console and is not used for three minutes.

The racing wheel automatically turns off if it is not connected to the PS3 console for four minutes.

To exit sleep mode or turn on the racing wheel:

- Press **START**. The racing wheel turns on and the LED lights.

Low battery warning

When the battery charge is getting low, the LED on the racing wheel flashes. You need to replace the batteries.

Warning: Make sure that you insert the batteries correctly. If the batteries are inserted incorrectly personal injury or damage to the racing wheel may occur.

Troubleshooting

In some games, the racing wheel must be assigned to controller 1.

To assign the racing wheel to controller 1:

- Press and hold HOME and assign the racing wheel to controller 1. The red LED above the power switch indicates that the wireless connection has been made successfully.

If the red LED is not on, make sure that the receiver is plugged in and the batteries are installed correctly, then turn racing off then on again. The LED should light within 10 seconds.

Legal notices

FCC Part 15

This device complies with Part 15 of the FCC Rules. Operation of this product is subject to the following two conditions: (1) this device may not cause harmful interference, and (2) this device must accept any interference received, including interference that may cause undesired operation.

FCC warning

Changes or modifications not expressly approved by the party responsible for compliance with the FCC Rules could void the user's authority to operate this equipment.

Canada ICES-003 statement

This Class B digital apparatus complies with Canadian ICES-003.

90-Day Limited Warranty

Rocketfish Products ("Rocketfish") warrants to you, the original purchaser of this new **RF-GPS3009** ("Product"), that the Product shall be free of defects in the original manufacture of the material or workmanship for 90 days from the purchase of the Product ("Warranty Period"). This Product must be purchased from an authorized dealer of Rocketfish brand products and packaged with this warranty statement. This warranty does not cover refurbished Product. If you notify Rocketfish during the Warranty Period of a defect covered by this warranty that requires service, terms of this warranty apply.

How long does the coverage last?

The Warranty Period lasts for 90 days, beginning on the date you purchased the Product. The purchase date is printed on the receipt you received with the product.

What does this warranty cover?

During the Warranty Period, if the original manufacture of the material or workmanship of the Product is determined to be defective by an authorized Rocketfish repair center or store personnel, Rocketfish will (at its sole option): (1) repair the Product with new or rebuilt parts; or (2) replace the Product at no charge with new or rebuilt comparable products or parts. Products and parts replaced under this warranty become the property of Rocketfish and are not returned to you. If service of Products and parts are required after the Warranty Period expires, you must pay all labor and parts charges. This warranty lasts as long as you own your Rocketfish Product during the Warranty Period. Warranty coverage terminates if you sell or otherwise transfer the Product.

How to obtain warranty service?

If you purchased the Product at a retail store location, take your original receipt and the Product to the store you purchased it from. Make sure that you place the Product in its original packaging or packaging that provides the same amount of protection as the original packaging. If you purchased the Product from an online web site, mail your original receipt and the Product to the address listed on the web site. Make sure that you put the Product in its original packaging or packaging that provides the same amount of protection as the original packaging.

Where is the warranty valid?

This warranty is valid only to the original purchaser of the Product in the United States, Canada, and Mexico.

What does the warranty not cover?

This warranty does not cover:

- Customer instruction
- Installation
- Set up adjustments
- Cosmetic damage

- Damage due to acts of God, such as lightning strikes
- Accident
- Misuse
- Abuse
- Negligence
- Commercial use
- Modification of any part of the Product, including the antenna

This warranty also does not cover:

- Damage due to incorrect operation or maintenance
- Connection to an incorrect voltage supply
- Attempted repair by anyone other than a facility authorized by Rocketfish to service the Product
- Products sold as is or with all faults
- Consumables, such as fuses or batteries
- Products where the factory applied serial number has been altered or removed

REPAIR REPLACEMENT AS PROVIDED UNDER THIS WARRANTY IS YOUR EXCLUSIVE REMEDY. ROCKETFISH SHALL NOT BE LIABLE FOR ANY INCIDENTAL OR CONSEQUENTIAL DAMAGES FOR THE BREACH OF ANY EXPRESS OR IMPLIED WARRANTY ON THIS PRODUCT, INCLUDING, BUT NOT LIMITED TO, LOST DATA, LOSS OF USE OF YOUR PRODUCT, LOST BUSINESS OR LOST PROFITS. ROCKETFISH PRODUCTS MAKES NO OTHER EXPRESS WARRANTIES WITH RESPECT TO THE PRODUCT, ALL EXPRESS AND IMPLIED WARRANTIES FOR THE PRODUCT, INCLUDING, BUT NOT LIMITED TO, ANY IMPLIED WARRANTIES OF AND CONDITIONS OF MERCHANTABILITY AND FITNESS FOR A PARTICULAR PURPOSE, ARE LIMITED IN DURATION TO THE WARRANTY PERIOD SET FORTH ABOVE AND NO WARRANTIES, WHETHER EXPRESS OR IMPLIED, WILL APPLY AFTER THE WARRANTY PERIOD. SOME STATES, PROVINCES AND JURISDICTIONS DO NOT ALLOW LIMITATIONS ON HOW LONG AN IMPLIED WARRANTY LASTS, SO THE ABOVE LIMITATION MAY NOT APPLY TO YOU. THIS WARRANTY GIVES YOU SPECIFIC LEGAL RIGHTS, AND YOU MAY ALSO HAVE OTHER RIGHTS, WHICH VARY FROM STATE TO STATE OR PROVINCE TO PROVINCE.

Contact Rocketfish:

For customer service please call 1-800-620-2790
www.rocketfishproducts.com

Distributed by Best Buy Purchasing, LLC
 7601 Penn Avenue South, Richfield, Minnesota, U.S.A. 55423-3645
 © 2008 Best Buy Enterprise Services, Inc.

All rights reserved. ROCKETFISH is a trademark of Best Buy Enterprise Services, Inc. Registered in some countries. All other products and brand names are trademarks of their respective owners.

www.rocketfishproducts.com (800) 620-2790

Distributed by Best Buy Purchasing, LLC

7601 Penn Avenue South, Richfield, MN 55423-3645 USA

© 2008 Best Buy Enterprise Services, Inc.

All rights reserved. ROCKETFISH is a trademark of Best Buy Enterprise Services, Inc.
All other products and brand names are trademarks of their respective owners.



ENGLISH
08-1614