



S1A1094202

⚠️ DANGER

HAZARD OF ELECTRIC SHOCK, EXPLOSION, OR ARC FLASH

- Read and understand this quick start guide before performing any procedure with this drive.
 - The user is responsible for compliance with all international and national electrical code requirements with respect to grounding of all equipment.
 - Many parts of this drive, including the printed circuit boards, operate at the line voltage. **DO NOT TOUCH.** Use only electrically insulated tools.
 - **DO NOT** touch unshielded components or terminal strip screw connections with voltage present.
 - **DO NOT** short across terminals PA/+ and PC/- or across the DC bus capacitors.
 - Before servicing the drive:
 - Disconnect all power, including external control power that may be present.
 - Place a "DO NOT TURN ON" label on all power disconnects.
 - Lock all power disconnects in the open position.
 - **WAIT 15 MINUTES** to allow the DC bus capacitors to discharge.
 - Measure the voltage of the DC bus between the PA/+ and PC/- terminals to ensure that the voltage is less than 42 Vdc.
 - If the DC bus capacitors do not discharge completely, contact your local Schneider Electric representative. Do not repair or operate the drive
 - Install and close all covers before applying power or starting and stopping the drive.
- Failure to follow these instructions will result in death or serious injury.**

Electrical equipment should be installed, operated, serviced, and maintained only by qualified personnel. No responsibility is assumed by Schneider Electric for any consequences arising out of the use of this product.

Information below is designed to use **single drive** connected to **single motor with a motor cable length less than 50 meters (164 ft)**. In any other case, consult the ATV312 installation manual (BBV46391) and programming manual (BBV46385) on www.schneider-electric.com.

1 Check the delivery of the drive

- Remove ATV312 from the packaging and check that it has not been damaged.

⚠️ WARNING

DAMAGED DRIVE EQUIPMENT

Do not operate or install any drive or drive accessory that appears damaged.
Failure to follow these instructions can result in death, serious injury, or equipment damage.

- Check that the drive reference printed on the label matches the delivery note and corresponding purchase order.

Write the drive Model Reference: _____ and Serial Number: _____

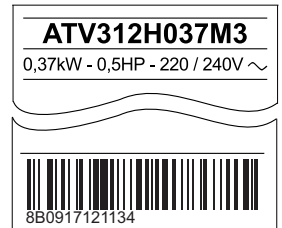

2 Check the line voltage compatibility

- Check that the **line voltage** is compatible with the supply range of the drive.
 Line voltage _____ Volts / Drive voltage range _____ Volts
 Drive range: ATV312.....M2 = 200/240 V single phase / ATV312.....M3=200/240 V three-phase
 ATV312.....N4 = 380/500 V three-phase / ATV312.....S6 = 525/600 V three-phase

3 Mount the drive vertically

For a surrounding air temperature up to 50 °C (122 °F)

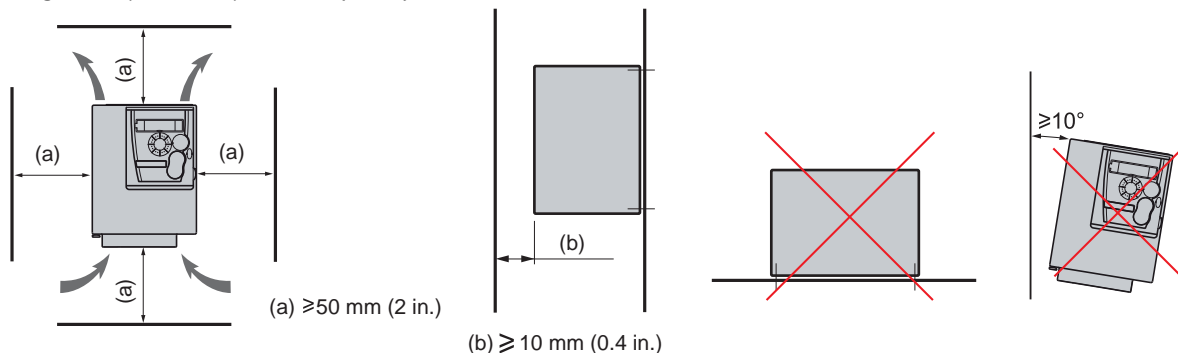

See installation manual (BBV46391) on www.schneider-electric.com for other thermal conditions.

4 Connect power wiring

- Wire the drive to the ground.
- Check circuit breaker rating or fuse rating (see SCCR annex)
- Check that the motor voltage is compatible with the drive voltage.
Motor voltage _____ Volts.
- Wire the drive to the motor.
- Wire the drive to the line supply.

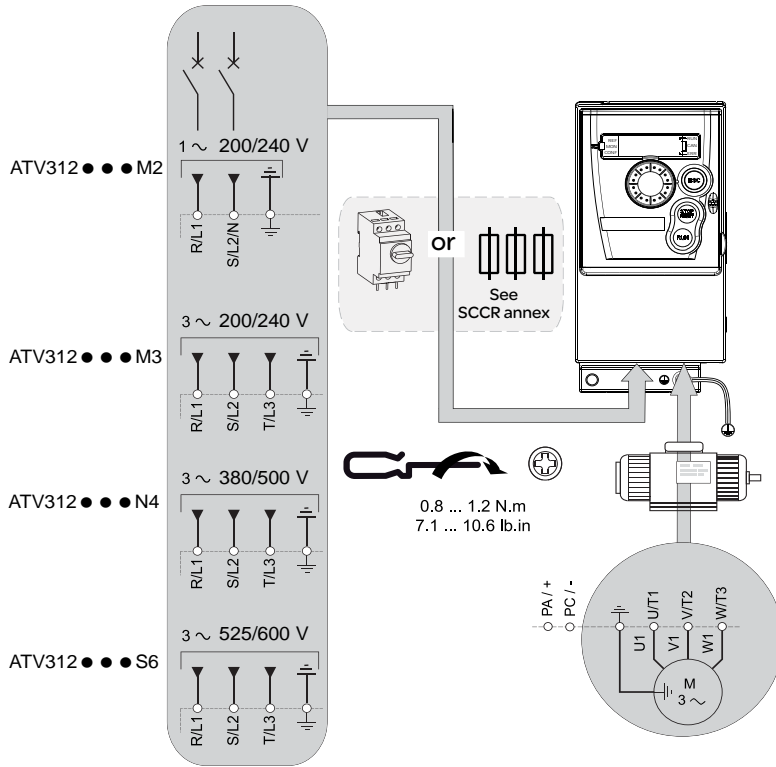

5 Connect control wiring and select control configuration:

51 or 52

51 [REMOTE configuration] (Control by external reference)

- Ensure SW1 = "SOURCE" Source
CLI
SINK
- Wire the speed reference:

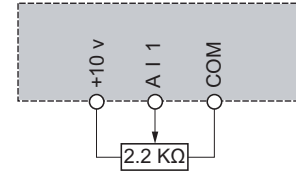

- Wire the command:

Control command 2-wire:

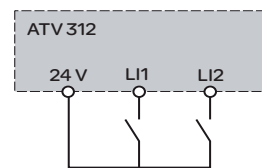

LI1: forward
LI2: reverse

Control command 3-wire:

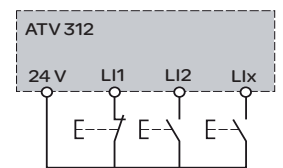

LI1: stop
LI2: forward
Lix: reverse

- Next steps, do: 6 + 7 + 8 + 91

52 [LOCAL configuration] (control by internal reference).

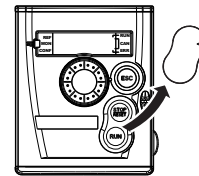

Do: 6 + 7 + 8 + 92

6 Apply power to the drive

- Ensure that Logic Inputs are not active (see Li1, Li2, Lix).
- Apply power to the drive.
- At first power up, the drive displays *nSt* (3-wire control) or *rdY* (2-wire control), after pushed drive displays *bFr*.
- On next start-ups, the drive displays *nSt* or *rdY*.

7 Set motor parameters

- Refer to the motor nameplate for the following parameter settings.

Menu	Code	Description	Factory setting	Customer setting
<i>drC-</i> [MOTOR CONTROL]	<i>bFr</i>	[Standard mot. freq]: Standard motor frequency (Hz)	<i>50.0</i>	
	<i>UnS</i>	[Rated motor volt.]: Nominal motor voltage on motor nameplate (V)	drive rating	
	<i>Frs</i>	[Rated motor freq.]: Nominal motor frequency on motor nameplate (Hz)	<i>50.0</i>	
	<i>nCr</i>	[Rated mot. current.]: Nominal motor current on motor nameplate (A)	drive rating	
	<i>nSP</i>	[Rated motor speed]: Nominal motor speed on motor nameplate (rpm)	drive rating	
	<i>COs</i>	[Motor 1 Cosinus Phi.]: Nominal motor cos φ on motor nameplate	drive rating	

7 Set motor parameters (continued)

- Set *tUn* parameter to *YES*.

Menu	Code	Description	Factory setting	Customer setting
<i>drC -</i> [MOTOR CONTROL]	<i>tUn</i>	[Auto Tunning]: Auto-Tuning for <i>UnS</i> , <i>FrS</i> , <i>nCr</i> , <i>nSP</i> , <i>nPr</i> and <i>COS</i>	<i>nD</i>	

⚠ ⚠ DANGER

HAZARD OF ELECTRIC SHOCK OR ARC FLASH

- During auto-tuning, the motor operates at rated current.
- Do not service the motor during auto-tuning.

Failure to follow these instructions will result in death or serious injury.

⚠ DANGER

UNINTENDED EQUIPMENT OPERATION

- The Nominal Motor Parameters *UnS*, *FrS*, *nCr*, *nSP*, *nPr* and *COS* must be correctly configured before starting auto-tuning.
- If one or more of these parameters is modified after auto-tuning has been performed, *tUn* will return to *nD* and the procedure must be repeated.

Failure to follow these instructions will result in death or serious injury.

8 Set basic parameters

Menu	Code	Description	Factory setting	Customer setting
<i>SEt -</i> [SETTINGS]	<i>ACC</i>	[Acceleration]: Acceleration time (s)	<i>3.0</i>	
	<i>DEC</i>	[Deceleration]: Deceleration time (s)	<i>3.0</i>	
	<i>LSP</i>	[Low speed]: Motor frequency at minimum reference (Hz)	<i>0.0</i>	
	<i>HSP</i>	[High speed]: Motor frequency at maximum reference (Hz)	<i>50.0</i>	
	<i>IEH</i>	[Mot. therm. current]: Nominal current on motor nameplate (A)	drive rating	
<i>I-D -</i> [INPUTS / OUTPUTS CFG]	<i>rrS</i>	[Reverse assign.]: Reverse assignment	<i>L12</i>	
<i>Fun -> PSS -</i> [PRESET SPEEDS]	<i>P52</i>	[2 preset speeds]: Preset speeds	<i>L13</i>	
	<i>P54</i>	[4 preset speeds]: Preset speeds	<i>L14</i>	
<i>Fun -> SA1 -</i> [SUMMING INPUTS]	<i>SA2</i>	[Summing ref. 2] Analog input	<i>A12</i>	

9 Set control choice

Menu	Code	Description	5.1 [REMOTE configuration]	5.2 [LOCAL configuration]	Customer Setting
<i>CtL -</i> [COMMAND]	<i>Fr1</i>	[Ref.1 channel]: Reference control	<i>A11</i> (factory setting), <i>A12</i> , <i>A13</i>	<i>A1U1</i>	
<i>I-D -</i> [INPUTS / OUTPUTS CFG]	<i>tCC</i>	[2/3 wire control]: Command control	<i>2C</i> : 2-wire (factory setting) <i>3C</i> : 3-wire	<i>L0C</i>	

91 [REMOTE configuration] (Factory setting)

Factory settings of parameters:

Fr1 = *A11*
tCC = *2C*

92 [LOCAL configuration]

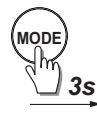

Factory settings of parameters:

Fr1 = *A1U1*
tCC = *L0C*
rrS = *L12*
P52 = *L13*
P54 = *L14*

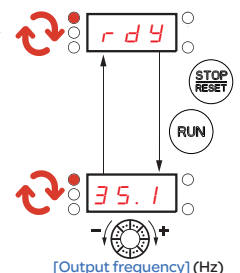

10 Start the motor

Menus structure

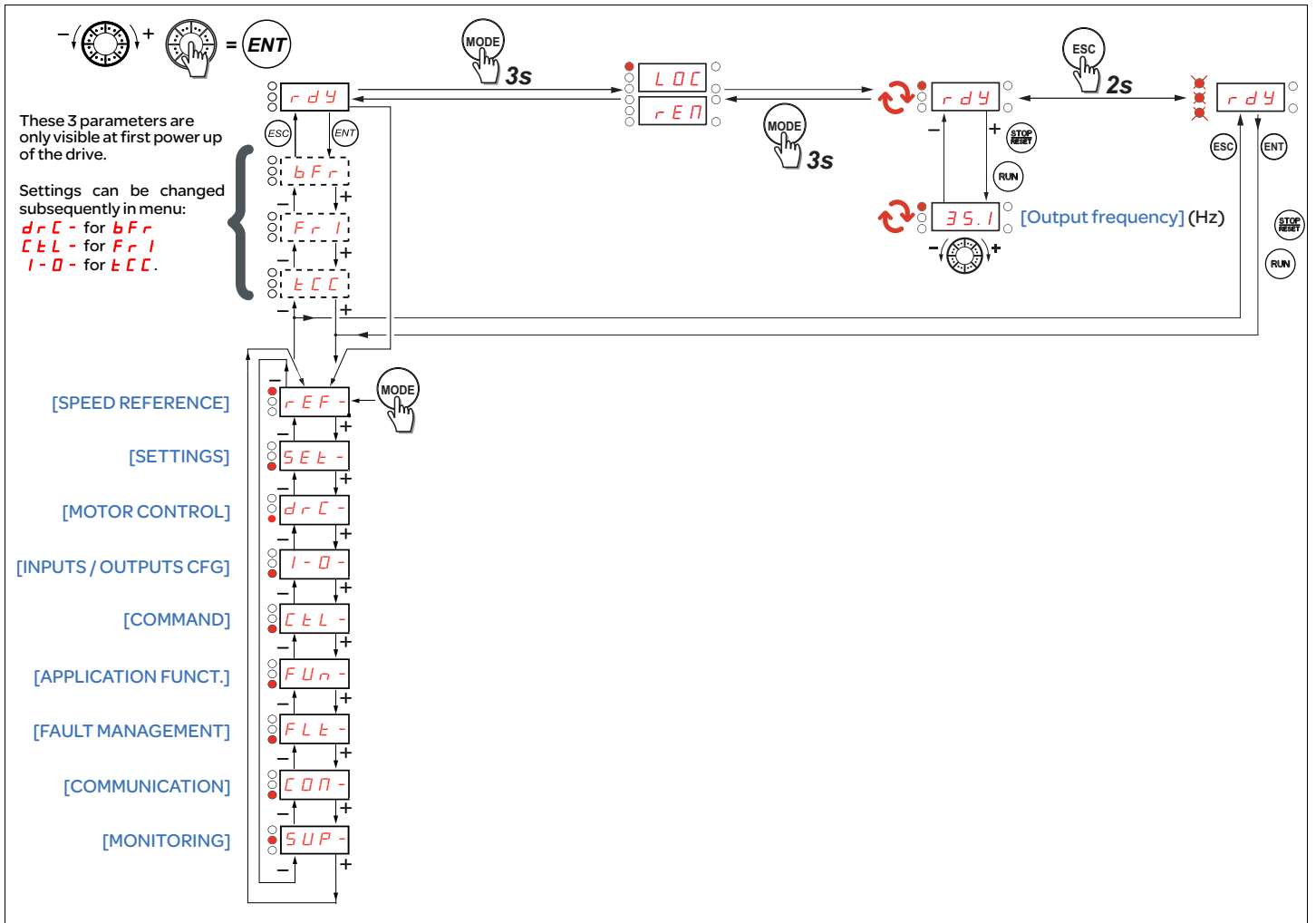

Parameter selection

