

Heating & Air Conditioning
Amana[®]

Goodman[®]

Air Conditioning & Heating

Heat Recovery Ventilators

HRV-150 • HRV-150D
HRV-200 • HRV-200D • HRV-300D

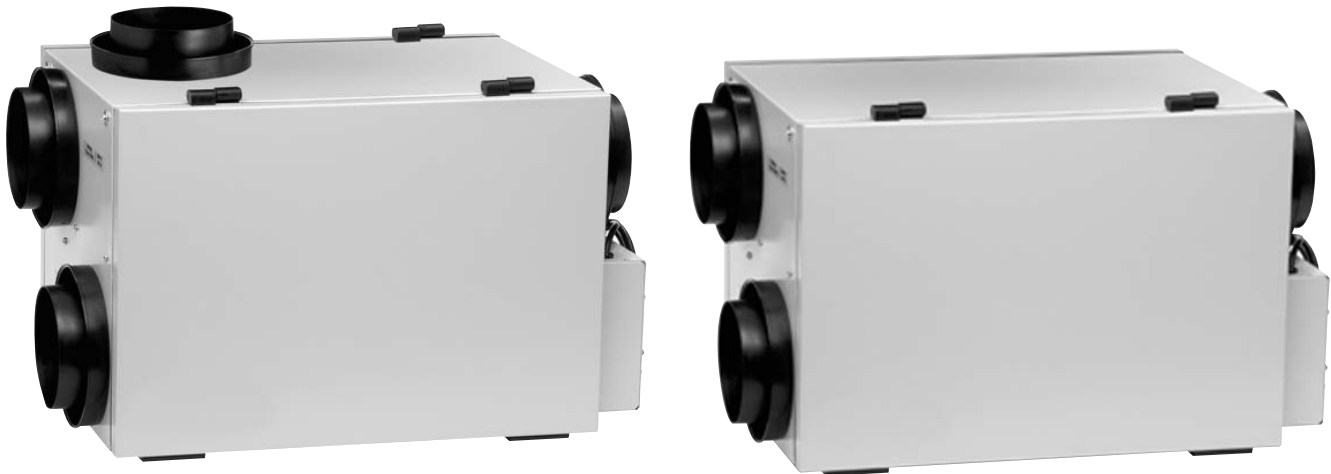

IMPORTANT - PLEASE READ THIS MANUAL BEFORE INSTALLING UNIT

CAUTION - Before installation, careful consideration must be given to how this system will operate if connected to any other piece of mechanical equipment, i.e. a forced air furnace or air handler, operating at a higher static. After installation, the compatibility of the two pieces of equipment must be confirmed by measuring the airflow's of the Heat Recovery or Energy Recovery Ventilators by using the balancing procedure found in this manual.

It is always important to assess how the operation of any HRV/ERV may interact with vented combustion equipment (i.e. Gas Furnaces, Oil Furnaces, Wood Stoves, etc.).

NEVER - install a ventilator in a situation where its normal operation, lack of operation or partial failure may result in the backdrafting or improper functioning of vented combustion equipment!!!

Your ventilation system should be installed in conformance with the appropriate provincial or state requirements or in the absence of such requirements with the current edition of the National Building Code, and / or ASHRAE's " Good Engineering Practices".

INSTALLATION, OPERATION AND MAINTENANCE MANUAL

Goodman is a registered trademark of Goodman Company, L.P.

Amana is a registered trademark of Maytag Corporation and used under license to Goodman Company, L.P.

All rights reserved.

TABLE OF CONTENTS

TECHNICAL DATA

HRV(D) Series 3

HRV Series 5

HRV-300D.....7

OPERATION.....11

Modes Of Operation11

Optional Remote Controls..... 12

Digital Multi-Function Controls w/recirculation.....12

Digital Multi-Function Controls 13

INSTALLATION.....14

Mounting the Unit 14

Location & Ducting..... 15

Examples 18

Air Flow Balancing 22

MAINTENANCE 24

TROUBLESHOOTING..... 25

ELECTRICAL CONNECTIONS 26

Sizing (Example) for maximum airflow normally required.

HRVs are typically sized to ventilate the whole house at a minimum of 0.35 air changes per hour. To calculate, simply take the square footage of the house (including basement) and multiply by the height of the ceiling to get cubic volume. Then, divide by 60 and multiply by 0.35.

Example:

SQFT of House	1100
Basement	<u>1100</u>
Total SQFT	2200
Height of ceiling	<u>x 8</u>
Cubic volume	17600
	<u>/ 60</u>
Maximum airflow required (CFM)	293
	<u>x 0.35</u>
	103

* Always consult your local code for sizing requirements in your area.

Alternate Method

Room classification	Number of rooms	CFM (L/s)	CFM Required
Master bedroom		x 20 cfm (10 l/s)	=
Basement	yes or no	if yes add 20 cfm / 10 l/s if no = 0	=
Bedrooms		x 10 cfm (5 l/s)	=
Living room		x 10 cfm (5 l/s)	=
Others		x 10 cfm (5 l/s)	=
Kitchen		x 10 cfm (5 l/s)	=
Bathroom		x 10 cfm (5 l/s)	=
Laundry room		x 10 cfm (5 l/s)	=
Utility room		x 10 cfm (5 l/s)	=
Total Ventilation Requirements (add last column)			=

*****Illustrations & images in this manual may not be exactly like unit purchase, these illustrations & images are for examples only.*****

1 cfm = 0.47189 l/s
1 l/s = 3.6 m ³ /hr



Introducing the NEW Heat Recovery Ventilators (HRV). As with previous designs, incoming fresh outdoor air is filtered before it is heated by the stale outgoing air through a aluminum heat recovery core. The HRV then distributes the preheated fresh filtered air throughout the home by direct ductwork installed specifically for the HRV or through the ductwork of a forced-air system.

FEATURES:

- Compact Design
- Electrostatic Filters (washable)
- Airflow Balancing Using Our Easy "TRUE" Motor Adjustment
- External Screw Type Dry Contacts For Push Button Timers, Dehumidistat, Crank Timer & Digital Control.
- Easy Core Guide Channels For Removing Core
- Better Packaging For More Protection In Shipping

OPTIONAL CONTROLS

- DMFC-REC – Digital Multi-Function Control
- MD-4W – Mechanical Low Voltage Dehumidistat with On/Off Switch
- MD-2W – Mechanical Low Voltage Dehumidistat
- RT-15M – 15 Minute Push Button Timer
- CT-30M – 30 Minute Crank Timer
- AQS – Air Quality Sensor

External screw type dry contacts (provided)

HRV Series

HRV 150D & HRV 200D

SPECIFICATIONS

CASE 22 gauge galvanized steel on the HRV-200D & 24 gauge galvanized steel on the HRV 150D. Baked powder coated paint. Insulated with 1" (25 mm) high density polystyrene foam to prevent condensation and meet the requirements of the Underwriters Laboratories 94HF.

MOTORS Two (2) German-manufactured, factory-balanced ebm™ motors with backward curved blades. Motors come with permanently lubricated sealed bearings guarantee long life and maintenance-free operation. Seven (7) year limited warranty.*

CORE Aluminum heat recovery core configured for an efficient cross-flow ventilation. Core is 9" x 9" (229 x 229 mm) with a 15" (380 mm) depth HRV 150D or 12" x 12" (305 x 305 mm) with a 15" (380 mm) depth HRV 200D. Cores are manufactured to withstand extreme temperature variations.

FILTERS Two (2) Washable Electrostatic Panel Type Air Filters, HRV 150D is 8.5" (216mm) x 15" (380mm) x 0.125" (3mm), HRV 200D is 11.75" (298mm) x 15" (380mm) x 0.125" (3mm).

CONTROLS External three (3) position (Low/Stand By/Medium) rocker switch that will offer continuous ventilation. We offer a variety of external controls. (see optional controls)

DEFROST A preset 5 minute defrost sequence is activated at an outdoor air temperature of 23°F (-5°C) and lower.

During the defrost sequence, its mechanism uses a motorized damper to temporarily block the incoming fresh air stream allowing the warm air from the home to circulate through the HRV. The exhaust blower shuts down & the supply blower switches into high speed to maximize the effectiveness of the defrost strategy.

The unit then returns to normal operation for 25 minutes, and continues cycle.

SERVICEABILITY Core, filters, motors and drain pan can be easily serviced through latched access door. Core conveniently slides out with ease on an improved railing system. Electrical box, placed on the outside of the unit, can also be easily accessed.

* For details concerning warranties, please visit your local dealer.

HRV-150D & HRV-200D

Dimensions

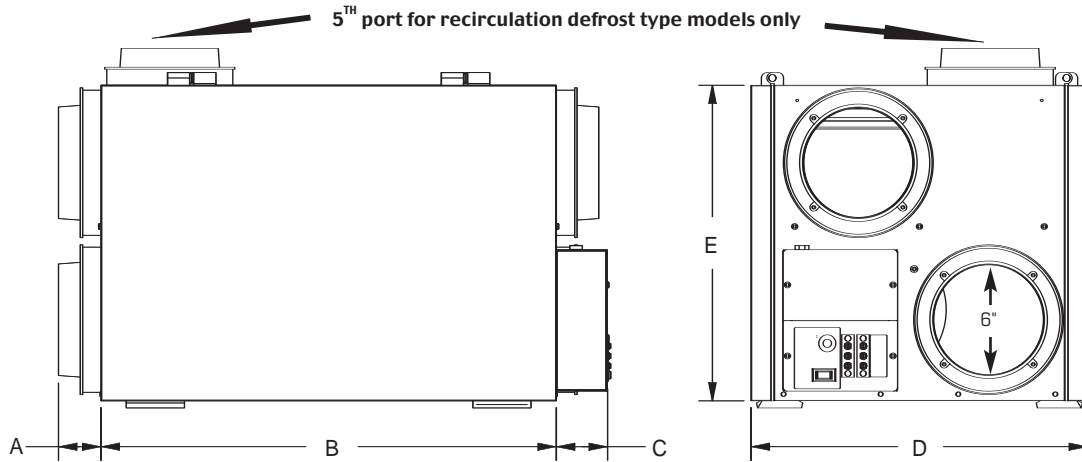

Model	A	B	C	D	E
HRV-150D	2 ¼" (56mm)	23 ½" (596mm)	2 ¾" (67mm)	17 ¾" (441mm)	17 ¾" (441mm)
HRV-200D	2 ¼" (56mm)	27 ⅞" (707mm)	2 ¾" (67mm)	17 ¾" (441mm)	20 ½" (520mm)

Fan Performance

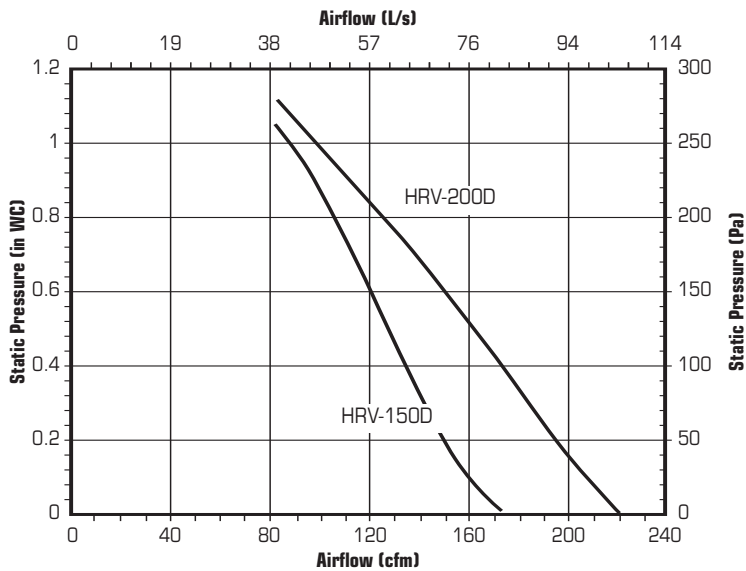

Performance Data

Model	Apparent Sensible Effectiveness at 32°F (0°C)	Apparent Sensible Effectiveness at -13°F (-25°C)
HRV-150D	72 %	69 %
HRV-200D	71 %	76 %

AIRFLOW CAP. cfm (L/s) @ 0.4 on High Speed

Power

- Volts: 120 VAC
- Amperage:
 - HRV-150D: 1.5 Amps Total
 - HRV-200D: 1.9 Amps Total
- Phase: Single Phase



Airflow

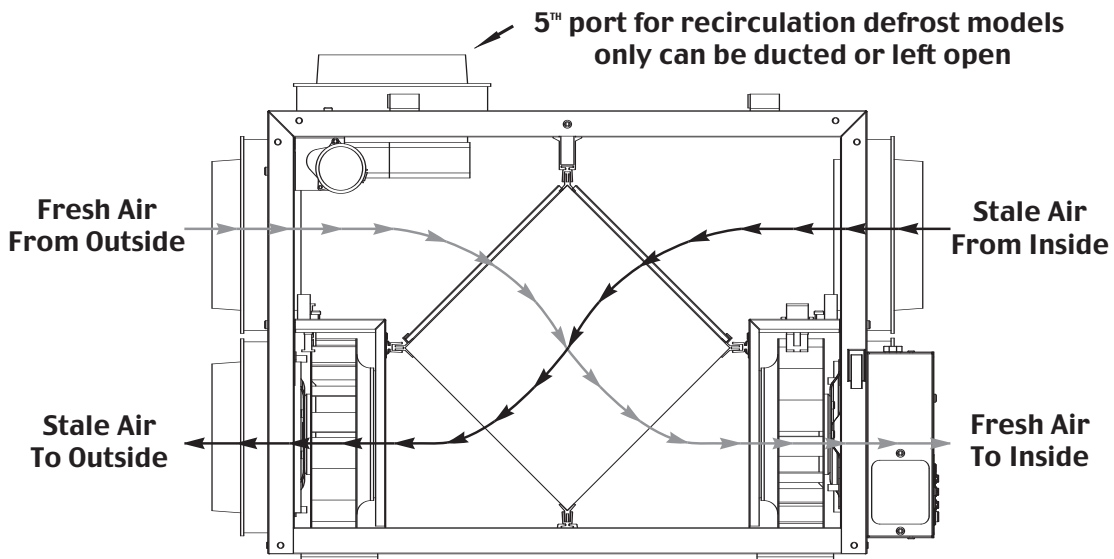

HRV Series

HRV 150 & HRV 200



Introducing the NEW Heat Recovery Ventilators (HRV). As with previous designs, incoming fresh outdoor air is filtered before it is heated by the stale outgoing air through an aluminum heat recovery core. The HRV then distributes the preheated fresh filtered air throughout the home by direct ductwork installed specifically for the HRV or through the ductwork of a forced-air system.

FEATURES:

- Compact Design
- Electrostatic Filters (washable)
- Balancing Dampers Included In Installation Kit
(not factory installed)
- External Screw Type Dry Contacts For Push Button Timers, Dehumidistats, Crank Timer & Digital Control.
- Easy Core Guide Channels For Removing Core
- Better Packaging For More Protection In Shipping

OPTIONAL CONTROLS

- DMFC – Digital Multi-Function Control
- MD-4W – Mechanical Low Voltage Dehumidistat with On/Off Switch
- MD-2W – Mechanical Low Voltage Dehumidistat
- RT-15M – 15 Minute Push Button Timer
- CT-30M – 30 Minute Crank Timer
- AQS – Air Quality Sensor

External screw type dry contacts (provided)

SPECIFICATIONS

CASE 22 gauge galvanized steel on the HRV-200 & 24 gauge galvanized steel on the HRV-150. Baked powder coated paint. Insulated with 1" (25 mm) high density polystyrene foam to prevent condensation and meet the requirements of the Underwriters Laboratories 94HF.

MOTORS Two (2) German-manufactured, factory-balanced ebm™ motors with backward curved blades. Motors come with permanently lubricated sealed bearings guarantee long life and maintenance-free operation. Seven (7) year limited warranty.*

CORE Aluminum heat recovery core configured for an efficient cross-flow ventilation. Core is 9" x 9" (229 x 229 mm) with a 15" (380 mm) depth HRV-150 or 12" x 12" (305 x 305 mm) with a 15" (380 mm) depth HRV-200. Cores are manufactured to withstand extreme temperature variations.

FILTERS Two (2) Washable Electrostatic Panel Type Air Filters, HRV-150 is 8.5" (216mm) x 15" (380mm) x 0.125" (3mm), HRV-200 is 11.75" (298mm) x 15" (380mm) x 0.125" (3mm).

CONTROLS External three (3) position (Low/Stand By/Medium) rocker switch that will offer continuous ventilation. We offer a variety of external controls. (see optional controls)

DEFROST A preset 5 minute defrost sequence is activated at an outdoor air temperature of 23°F (-5°C) and lower.

During the defrost sequence, the supply blower shuts down & the exhaust blower switches into high speed to maximize the effectiveness of the defrost strategy.

The unit then returns to normal operation for 25 minutes, and continues cycle.

SERVICEABILITY Core, filters, motors and drain pan can be easily serviced through latched access door. Core conveniently slides out with ease on an improved railing system. Electrical box, placed on the outside of the unit, can also be easily accessed.

* For details concerning warranties, please visit your local dealer.

HRV-150 & HRV-200

Dimensions

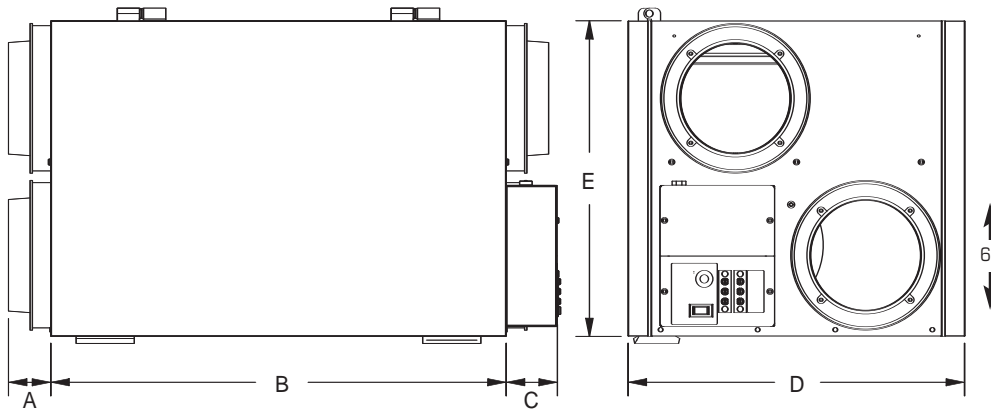

Model	A	B	C	D	E
HRV-150	2 ¼" (56mm)	23 ½" (596mm)	2 ⅝" (67mm)	17 ⅜" (441mm)	16 ⅛" (413mm)
HRV-200	2 ¼" (56mm)	27 ⅞" (707mm)	2 ⅝" (67mm)	17 ⅜" (441mm)	20 ½" (520mm)

Fan Performance

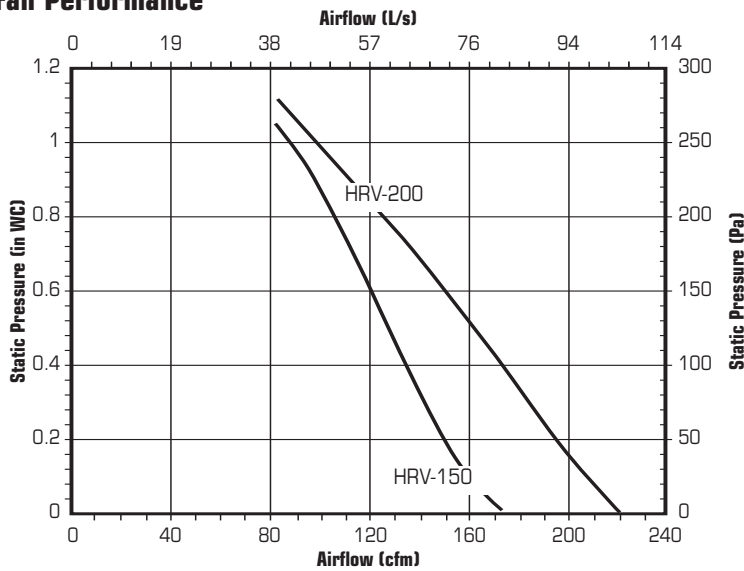

Performance Data

Model	Apparent Sensible Effectiveness at 32°F (0°C)	Apparent Sensible Effectiveness at -13°F (-25°C)
HRV-150	72 %	69 %
HRV-200	71 %	76 %

AIRFLOW CAP. cfm (L/s) @ 0.4 on High Speed

Power

- Volts: 120 VAC
- Amperage:
 - HRV-150: 1.5 Amps Total
 - HRV-200: 1.9 Amps Total
- Phase: Single Phase



Airflow

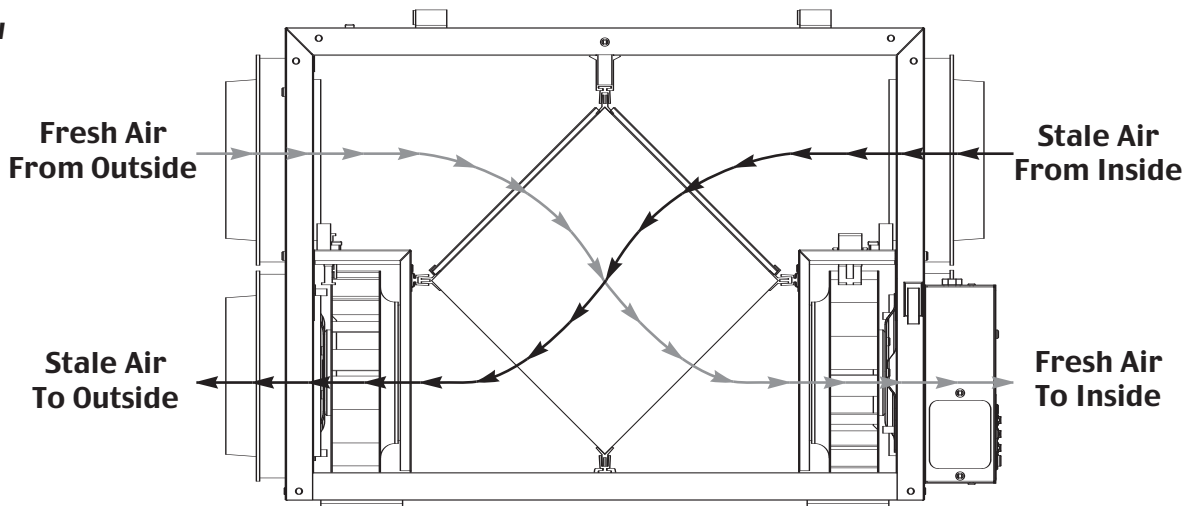

HRV Series

HRV-300D

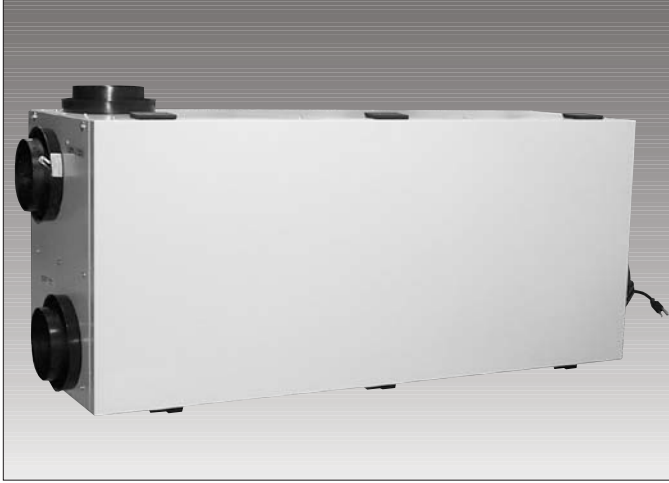

Introducing the NEW Heat Recovery Ventilators (HRV). As with previous designs, incoming fresh outdoor air is filtered before it is heated by the stale outgoing air. The HRV then distributes the preheated fresh filtered air throughout the home by direct ductwork installed specifically for the HRV or through the ductwork of a forced-air system.

FEATURES:

- Balancing Dampers Included In Installation Kit
(not factory installed)
- External Screw Type Dry Contacts For Push Button Timers, Dehumidistats, Crank Timer & Digital Control.

OPTIONAL CONTROLS

- DMFC-REC – Digital Multi-Function Control
- MD-4W – Mechanical Low Voltage Dehumidistat with On/Off Switch
- MD-2W – Mechanical Low Voltage Dehumidistat
- RT-15M – 15 Minute Push Button Timer
- CT-30M – 30 Minute Crank Timer
- AQS – Air Quality Sensor

External screw type dry contacts (provided)

SPECIFICATIONS

CASE 22 gauge galvanized steel. Baked powder coated paint. Insulated with 1" (25 mm) high density polystyrene foam to prevent condensation and meet the requirements of the Underwriters Laboratories 94HF.

MOTORS Two (2) German-manufactured, factory-balanced ebm™ motors with backward curved blades. Motors come with permanently lubricated sealed bearings guarantee long life and maintenance-free operation. Seven (7) year limited warranty.*

CORES Two (2) aluminum heat recovery cores configured for an efficient cross-flow ventilation. Core is 12" x 12" (305 x 305 mm) with a 15" (380 mm) depth. Cores are manufactured to withstand extreme temperature variations.

FILTERS Two (2) synthetic high quality filters for better indoor air quality and clean air.

CONTROLS External three (3) position (Low/Stand By/Medium) rocker switch that will offer continuous ventilation. We offer a variety of external controls. (see optional controls)

DEFROST A preset 5 minute defrost sequence is activated at an outdoor air temperature of 23°F (-5°C) and lower.

During the HRV-300 defrost sequence, its mechanism uses a motorized damper to temporarily block the incoming fresh air stream allowing the warm air from the home to circulate through the HRV. The exhaust blower shuts down & the supply blower switches into high speed to maximize the effectiveness of the defrost strategy.

The unit then returns to normal operation for 25 minutes, and continues cycle.

SERVICEABILITY Core, filters, motors and drain pan can be easily serviced through latched access door.

* For details concerning warranties, please visit your local dealer.

HRV-300D

Dimensions

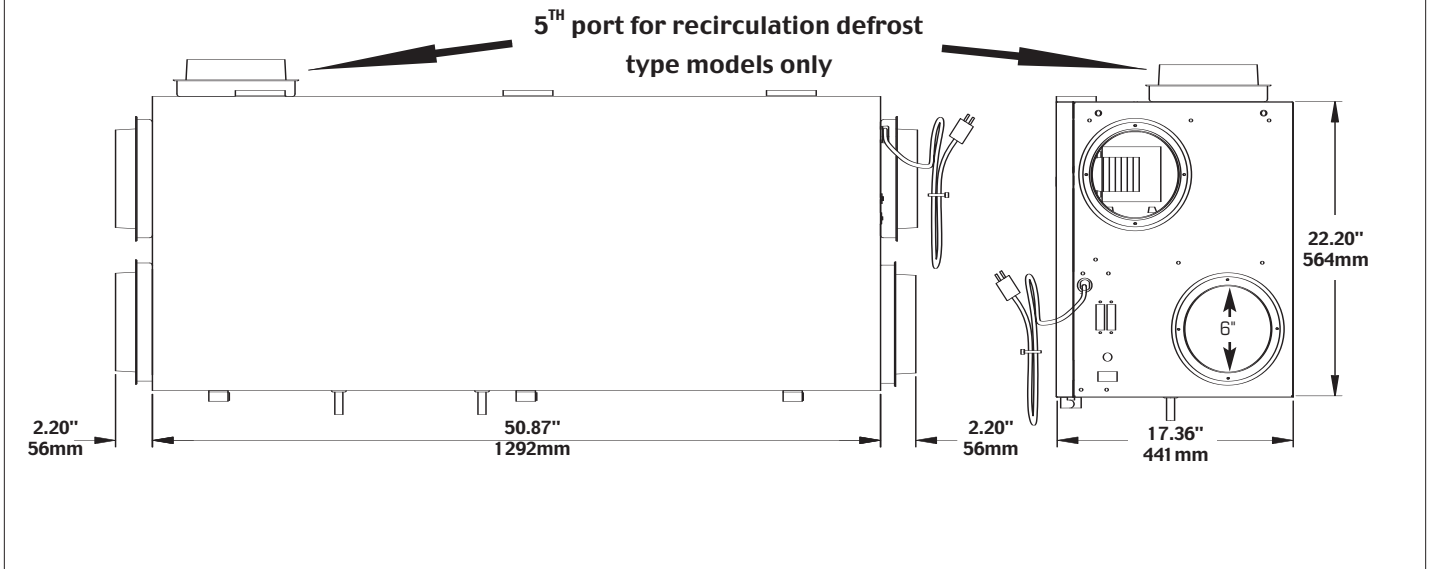

Fan Performance

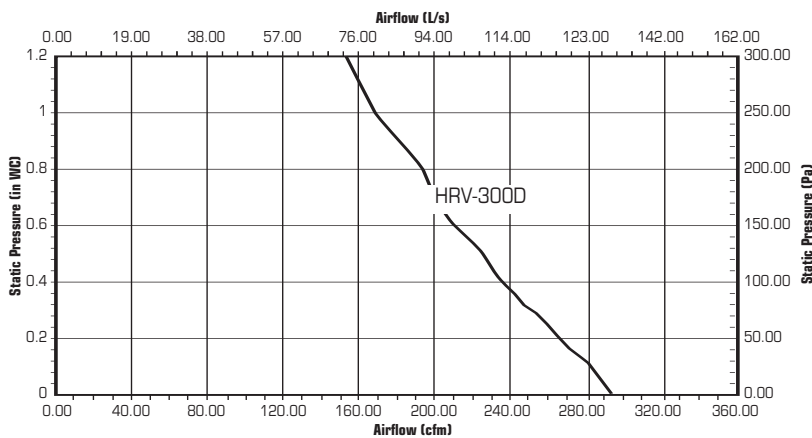

Performance Data

Model	Apparent Sensible Effectiveness at 32°F (0°C)	Apparent Sensible Effectiveness at -13°F (-25°C)
HRV-300D	92 %	91 %

AIRFLOW CAP. cfm (L/s) @ 0.4 on High Speed

Power

- Volts 120 VAC
- Amperage 2.7 Amps Total
- Phase Single Phase



Airflow

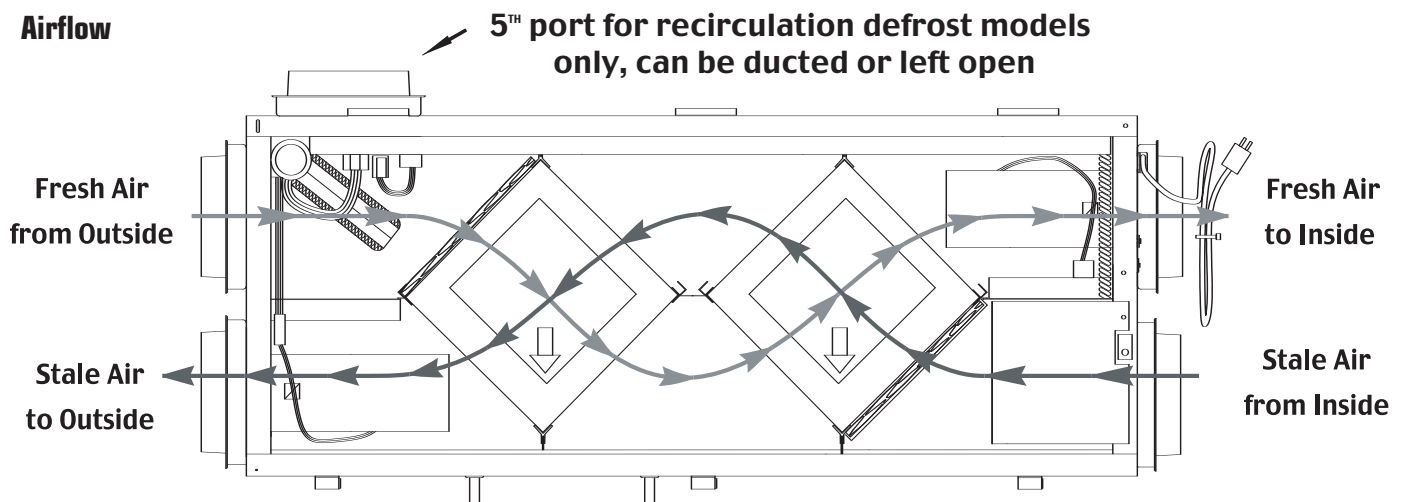

OPERATION

A Heat Recovery Ventilator (HRV) is designed to bring fresh air into a building while exhausting an equal amount of stale air. During the winter months, the incoming cold fresh air is warmed by utilizing the heat recovered from the stale air before it is exhausted to the outdoors. During summer months when the indoor space is air conditioned, the HRV will help in cooling the incoming fresh air with the stale air that is being exhausted.

Our HRV's are designed to run continuous or on intermittent, giving the homeowner complete control over their air quality. Continuous low speed ventilation is recommended, which will help eliminate carbon dioxide, voc's and other gases as well as freshen up the home. Intermittent high speed ventilation can be obtained through a variety of optional remote controls found in this manual (page 13). Below are some examples of seasonal operation of an HRV.



Winter:

Humidity control is very important during the winter months. This is when problems will be most apparent since condensation on the windows will often occur. The colder the outside temperature, the greater the risk of condensation in the home. The average relative humidity should be maintained between (30-60) to avoid condensation.

Low speed continuous ventilation with high speed override is recommended.



Spring:

Temperatures are more moderate and become warmer each day. To keep the humidity and temperature uniform, set the dehumidistat higher (if installed). You may also switch the HRV to standby mode if desired.



Summer:

The air is sometimes hot and humid. To stop the warm humid air from entering, set the dehumidistat at its highest level. If the digital control is installed, the air exchanger can be set to cycle the unit on and off as desired from that wall control. However, continuous ventilation is recommended.

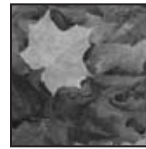

Fall:

Rain and rapid temperature changes make it difficult to control the internal humidity level and may result in condensation on the windows. A remote dehumidistat may help give greater control over the inside environment.

MODES OF OPERATION

The entire line of Heat Recovery comes equipped with our new electronic uni-control board which offers a wide variety of features making it the ultimate ventilation control system. Our engineers have used the latest technology to provide solid, trouble free operation under any conditions.

The uni-control board offers stand alone operating capabilities as well as an exclusive 2 wire communication to most external controls. The trouble-free optional controls include: two different rotary dial dehumidistats, an air quality sensor (3 wire communication required), a 15 minute remote push-button timer, as well as the most sophisticated line of remote wall mounted controls, the digital control.

An on-board diagnostic LED helps find problems quickly and efficiently. For example the LED can be used to signal a broken or shorted electronic wall control wire. Electronic air temperature probe gives this board accurate readings in order to minimize unnecessary defrost operation, and the on-board jumpers provide the user with the option of adjusting defrost time and sequence to optimize performance under abnormal conditions. The defrost operation is automatic and is usually never adjusted.

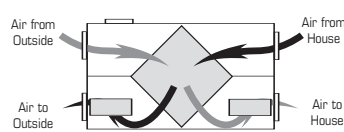

1. Continuous / Ventilation Mode

In this mode of operation both fans are operating and exchanging air with the outside. The heat recovery ventilator (HRV) constantly exchanges the air at the rate you select, either at low or medium speed, and switches to high speed when activated by an optional remote control. The "Low" and "Med" fan speed selection will cause the unit to operate in continuous exchange mode at an exchange rate of 35% and 50% maximum airflow rating respectively. Continuous mode is recommended, since pollutants are slowly but constantly being generated in your house.

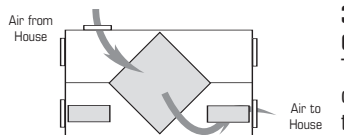

3. Defrost/Recirculation Mode (5 port "R" Models)

The automatic defrost cycle consists of a damper defrost which allows air to recirculate throughout the unit & home. When the supply air stream

temperature goes below -5°C (23°F), the exhaust motor shuts down, the supply motor goes to high speed, and a damper closes the supply, opening a 5th collar. The ambient air is then recirculated through the unit & home for a period of 5 minutes. The unit will then resume normal operation for a time period of 25 minutes. This damper defrost cycle continues until the supply air stream rises above 0°C (32°F). The recirculation feature can be obtained with the use of an optional digital control.

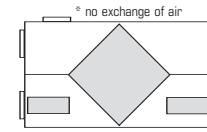

2. Intermittent / Standby Mode

The system is always on standby and operates at high speed when activated by an optional remote control. "Standby" should be selected if the user wishes to stop the unit from continuous exchange. We recommend that

the "Standby" mode only be used if your system is equipped with an optional external control, in which case, the unit would activate to "High" fan speed, until the control is satisfied and then return to standby (off).

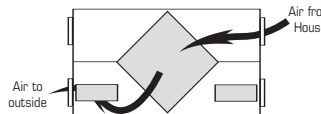

4. Defrost (Fan shutdown 4 port models)

The automatic defrost cycle consists of a fan shutdown. When the supply air stream temperature goes below -5°C (23°F), the supply

motor shuts down and the exhaust motor goes into high speed. Ambient air is passed through the unit for a period of 5 minutes. The supply motor will then re-start and run at the preset speed. The exhaust motor will also slow down to the preset speed, and the unit will operate in the run cycle for 25 minutes. This fan shutdown defrost cycle continues until the supply air stream rises above 0°C (32°F).

OPERATION (CONT'D)

PRACTICAL TIPS

To avoid window condensation:

- It is not necessary to change the humidity control every day. Monitor the average weekly temperature or experiment with various settings until you find a level that is comfortable for you. Adjust the control when needed.

NOTE:

A dehumidistat is ideal for use in energy efficient houses where indoor humidity (during the heating season) is higher than outdoor levels. High humidity is a major cause of structure damage and IAQ problems such as mold and mildew.

OPTIONAL REMOTE CONTROLS

* All controls are low voltage. 18 to 24 gauge wire is recommended.



2 wire installation



4 wire installation



3 wire installation



2 wire installation

Dehumidistat - MD-2W - The wall mount dehumidistat monitors the humidity level in the area it is installed. When the humidity level rises above the desired set-point, the HRV will activate to high speed/override mode. Once the humidity level returns to desired condition, the unit will return to the normal mode.

Dehumidistat - MD-4W - The wall mount dehumidistat offers the same features of the dehumidistat I plus additional off/on control for the HRV. Dial illuminates when in override mode.

Air Quality Sensor - AQS - The wall mount Air Quality Sensor (AQS) monitors indoor air quality and activates the override mode when carbon monoxide, formaldehyde, benzene, volatile organic compounds and other pollutants are detected. The unit will then return to normal mode once the air pollutants are reduced to a pre-determined lower level.

* This control is not a warning device.

15-min Timer - RT-15M - The 15-minute remote timer is typically installed in areas where contaminated such as moisture and odors, are produced. Simply push the button and the HRV will activate to high speed for 15 minutes. Up to 5 electronic timers can be installed throughout the building at a distance of up to 500 feet (152 meters) from the HRV.

PRACTICAL TIPS

NOTE:

When an digital control is installed, the rocker switch located on the right hand side of the HRV will be automatically deactivated giving the user complete control from wherever he/she wishes to mount the control pad.

NOTE:

The override speed cannot be set at a fan speed lower or equal to the normal operating fan speed. For example, if the unit is normally operating at a medium fan speed, the override fan speed will be automatically set to high.

NOTE:

DMFC-REC model, changing the override speed will change default override speed for other external controls.

EXAMPLES:

If on the DMFC-REC control, you have set the override control at medium, and you start an external remote control, the unit will run at medium speed for 15 min.

OPTIONAL DIGITAL CONTROL

DIGITAL DISPLAY

Shows Indoor Humidity Level
This control will not read below 29% RH

OVERRIDE TIMER

When pressed, unit will provide high speed ventilation for one 15, 30 or 60 minute period.

MAINTENANCE LIGHT

Light comes on when it's time to clean unit.

POWER

On/Off and Reset

MODES

Select Intermittent, Recirculation or Continuous Ventilation Modes

DEHUMIDISTAT CONTROL

(see description on top of this page)

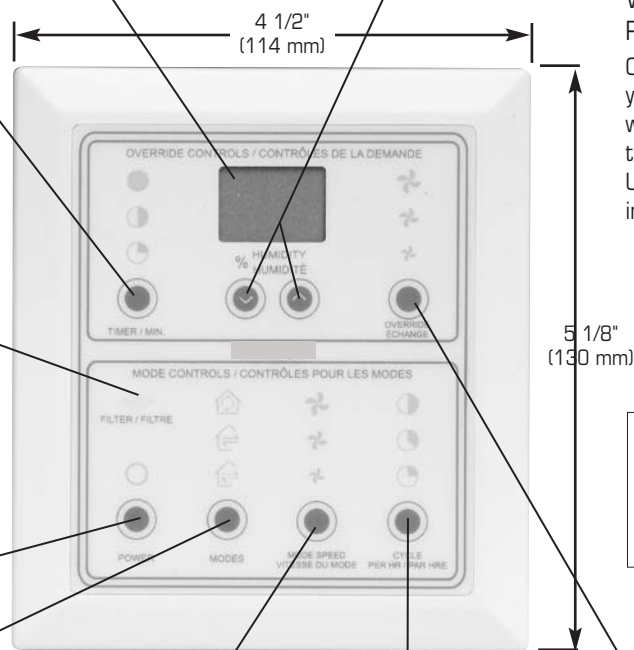

DMFC-REC

DIGITAL MULTI-FUNCTION WALL CONTROL WITH RECIRCULATION

Control multiple functions of your HRV with one slimline wall control. Two wire connection simplifies installation. Use one control per HRV installed.

Width = 4 1/2" (114mm)
Height = 5 1/8" (130mm)
Thickness = 5/8" (16mm)

* Both digital controls are the same size

MODE SPEED

Set Unit to Low, Medium or High Speed

CYCLE CONTROL

Set unit to cycle on 15, 20, or 30 minutes every hour

OVERRIDE SPEED CONTROL

Push to select override speed of unit.

OPERATION (CONT'D)

OPTIONAL DIGITAL CONTROL

DIGITAL DISPLAY

Shows Indoor Humidity Level
This control will not read below 29% RH

DEHUMIDISTAT CONTROL

A Dehumidistat is ideal for use in energy efficient houses where indoor humidity (during the heating season) is higher than outdoor levels. High humidity is a major cause of structure damage and IAQ problems such as mold and mildew.

OVERRIDE TIMER

When pressed, unit will provide high speed ventilation for 15 minute period. Once the time elapsed the unit will return to its normal function. To move from one time to the other, continue pressing the timer button until you reach the desired time.

POWER

On/Off and Reset
This function is to turn your unit on or off, in the off position the damper is open and you will feel the cold outside air come in. To go from the on to off position just press once.

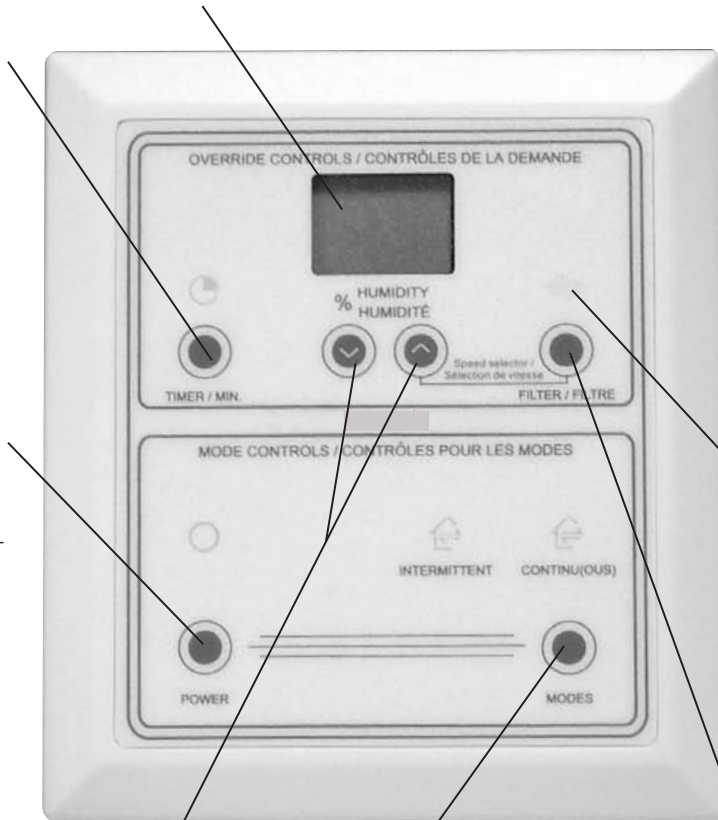

DMFC

DIGITAL MULTI-FUNCTION WALL CONTROL

Control multiple functions of your HRV with one slimline wall control. Two wire connection simplifies installation. Use one control per HRV installed.

MAINTENANCE LIGHT

Light comes on when it's time to clean unit. This function will let you know when it's time to check your filters and core. To reset your filter light, after you've cleaned or replaced the filters, just push the power button and restart the unit. This will turn the light off and reset the clock for your filter check.

DEHUMIDISTAT CONTROL

The LCD (Liquid Crystal Display) indicates the percentage of Relative Humidity in the air surrounding the control and ultimately in the house. Pressing either of the setpoint selectors (⬇️, ⬆️) once, will display the desired RH level. The setpoint selection mode is now activated and can be adjusted with either selectors to a newly desired setpoint. The LCD will return to the actual RH level display after a few seconds.

MODES

Select Intermittent, or Continuous Ventilation Modes.

Continuous

 This function will exchange outside air with your stale air.

Intermittent

 This function will put your unit on stand by and can be over ride by timer, air quality sensor, etc

To move from function to the other, continue pressing the mode button until you reach the desired function. This function goes from Recirculation, Continuous to Intermittent.

FILTER LIGHT RESET & MODE FAN SPEED SELECTOR

Press to reset the filter maintenance reminder light. The combination filter light reset and up setpoint selector buttons (⬆️) let's you choose at which speed the HRV, ERV unit will operate in continuous or recirculation mode only. Pressing the filter light reset button once displays the mode fan speed on the LCD. The LCD should display one of the following three letters, L for Low, M for Medium and H for High. To change the mode speed, press the up setpoint (⬆️) until desired speed is displayed, selector. After 1 second of inactivity, the LCD will return to relative humidity reading.

Note: All controls are low voltage. 18 to 24 gauge wire is recommended.

INSTALLATION

PRACTICAL TIPS

- Install the unit close to the outside wall on which the supply and exhaust hoods will be mounted.
- Have a nearby power supply 120 Volts, 60Hz.
- Have the possibility of mounting the unit to supporting beams.
- Mount the unit as level as possible in order to allow proper condensate drainage.
- Have access to a water drain for the condensate of the unit during defrost.
- Have a certain amount of heat around the unit (attic installation is not recommended).
- Minimize any noise level that would be created by the unit in the living area.
- Have access for future maintenance.

LOCATION

The HRV must be located in a heated space where it will be possible to conveniently service the unit. Typically the HRV would be located in the mechanical room or an area close to the outside wall where the weatherhoods will be mounted. If a basement area is not convenient or does not exist, a utility or laundry room may be used.

Attic installations are not normally recommended due to:

- the complexity of work to install
- freezing conditions in the attic
- difficulty of access for service and cleaning

Connecting appliances to the HRV It is not recommended, including:

- clothes dryer
- range top
- stovetop fan
- central vacuum system

These appliance may cause lint, dust or grease to collect in the HRV, damaging the unit.

NOTE: Connecting any of these type of appliances to the HRV will invalidate your warranty

MOUNTING



- 1 Place Fastening hooks on the strapping board or the floor joists.



- 2 Attach a hanging chain (provided) to each 10 3/4" (19 mm) bolt (provided) in the top 4 corners of the unit and tighten.

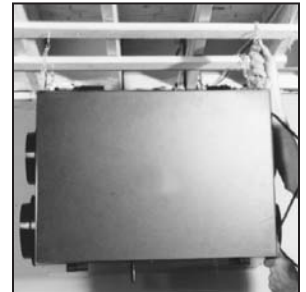

- 3 Hang the unit by slipping a link onto the hanging hooks, making sure the unit is level.

Installing Drain Line

Through normal operation and during its defrost mode, the HRV may produce some condensation. This water should flow into a nearby drain, or be taken away by a condensate pump. The HRV and all condensate lines must be installed in a space where the temperature is maintained above the freezing point. A "P" trap should be made in the drain line. This will prevent odors from being drawn back up into the unit.

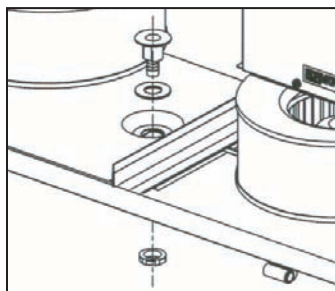

- 1 Install the drain nipple.



- 2 Install the drain hose, making a "P" trap

INSTALLING DUCTS GOING TO / FROM OUTSIDE

A well designed and installed ducting system will allow the HRV to operate at its maximum efficiency. Always try to keep duct runs as short and straight as possible.

See Installation Diagrams for installation examples.

PRACTICAL TIPS

- Decide where your intake and exhaust hoods will be located.

Locating the Intake Weatherhood

- Should be located upstream (if there are prevailing winds) from the exhaust outlet
- At least 4' - 6' (2m) from the exhaust weatherhood
- At least 6' (2m) away from dryer vents and furnace exhaust (medium or high efficiency furnaces)
- A minimum of at least 6' (2m) from driveways, oil fill pipes, gas meters, or garbage containers
- At least 18" (457mm) above the ground, or above the depth of expected snow accumulation
- At least 3' (1m) from the corner of the building
- Do not locate in a garage, attic or crawl space

Locating the Exhaust Weatherhood

- At least 4' - 6' (1m - 2m) from the ventilation air intake
- At least 18" (457mm) above ground or above the depth of expected snow accumulation
- At least 3' (1m) away from the corner of the building
- Not near a gas meter, electric meter or a walkway where fog or ice could create a hazard
- Not into a garage, workshop or other unheated space

When installing the weatherhood, its outside perimeter must be sealed with exterior caulking.

INSTALLING THE DUCTING TO THE WEATHERHOODS

The inner liner of the flexible insulated duct must be clamped to the sleeve of the weatherhoods (as close to the outside as possible) and to the appropriate port on the HRV. The insulation should remain full and not be squished. The outer liner, which acts as a vapor barrier must be completely sealed to outer wall and the HRV using tape and or caulking. A good bead of high quality caulking (preferably acoustical sealant) will seal the inner flexible duct to both the HRV port and the weatherhood prior to clamping.

To minimize air flow restriction, the flexible insulated duct that connects the two outside weatherhoods to the HRV should be stretched tightly and be as short as possible. Twisting or folding the duct will severely restrict air flow.

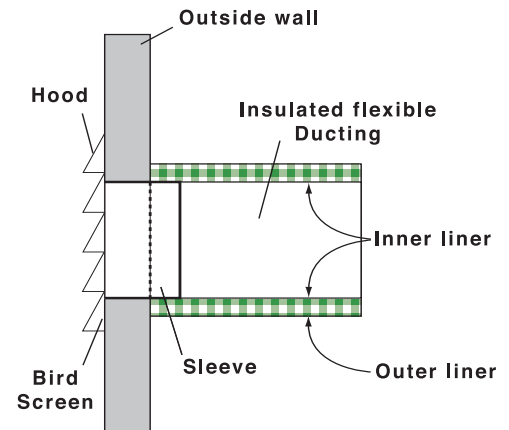

Model	Description
SEH-6P	Supply & Exhaust Plastic Hood Kit
SEH-6M	Supply & Exhaust Metal Hood Kit

* Application for Supply or Exhaust



1 Using the collar of the outside hood, outline the intake & exhaust holes to be cut. The holes should be slightly larger than the collar to allow for the thickness of the insulated flexible duct. Cut a hole for both the intake and exhaust hoods.



2 Pull the insulated flexible duct through the opening until it is well extended and straight. Slide the duct's inner vinyl sleeve over the hood collar and secure, pull the insulation over the duct and then the vapor barrier over the sleeve and secure with duct tape.



3 Push the hood into the opening. Attach the hood to the outside wall with mounting screws. Repeat the installation procedure for both the Supply and Exhaust hood.

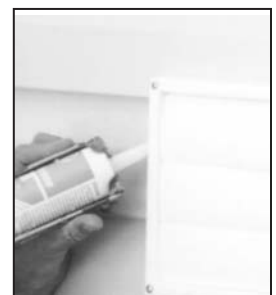

4 Using a caulking gun, seal around both hoods to prevent any leaks.

INSTALLING DUCTS TO / FROM INSIDE

To maximize airflow in the ductwork system, all ducts should be kept short and have as few bends or elbows as possible. Forty-five degree are preferred to 90° elbows. Use “Y” tees instead of 90° elbows whenever possible.

All duct joints must be fastened with screws or duct sealant and wrapped with a quality duct tape to prevent leakage. Aluminum foil duct tape is recommended. Galvanized ducting from the HRV to the living areas in the house is recommended whenever possible, although flexible duct can be used in moderation when necessary.

SUPPLY AIR DUCTING

In homes without a forced air furnace, fresh air should be supplied to all habitable rooms including, bedrooms and living areas. It should be supplied from high wall or ceiling locations. Grilles that diffuse the air comfortably are recommended. To avoid possible noise transfer through the ductwork system, a short length (approximately 12”, 300 mm) of nonmetallic flexible insulated duct should be connected between the HRV and the supply/exhaust ductwork system.

The main supply and return lines to/from the HRV must be 6 inches (150 mm) minimum. Branch lines to the individual rooms may be as small as 4 inches (100 mm), but 5 inch (125 mm) lines are preferred. If the floor is the only option available, then special care should be taken in locating grilles. Areas such as under baseboard heaters will help to temper the air. Also optional inline duct heaters are available for mounting in the supply duct work to add heat if required. In homes with a forced air furnace, you may want to connect the HRV to the furnace ductwork (see information below).

PRACTICAL TIPS

- Building Codes and Combustion Appliance Installation Codes do not allow location of return air grilles or any opening such as a “breathing tee” in an enclosed room with spillage susceptible combustion appliances.
- The fresh air inlet from the HRV needs to respect a minimum distance from the furnace return drop to ensure proper air mixing and temperature at the furnace core. See furnace manufacturer for appropriate specifications.

Direct Connection

- A direct connection requires that the fan of the furnace runs continuously. It may be inter-linked electrically (low voltage) with the HRV (Accessory Control Contacts) for intermittent demand. Should you wish to hard duct the supply air directly into the cold air return of the furnace, remember to check the airflow balance of the HRV with the furnace fan both “on” and “off” to determine that it does not imbalance the HRV more than 10%. Make sure you respect the 1m minimum distance from the supply air in of the HRV and the furnace (Refer to your local and National Building & Heating Codes for any variations in these notes).

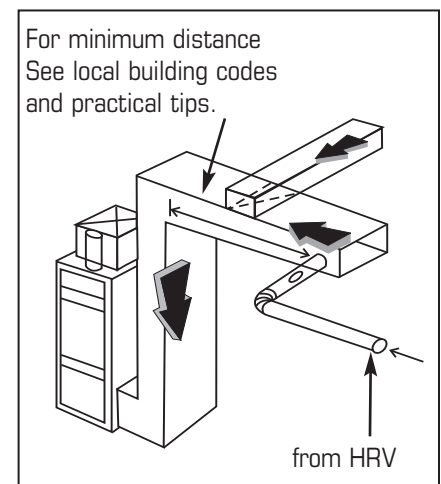

INSTALLING DUCTS TO / FROM INSIDE (CONT'D)

Exhaust Air Ducting

The stale air exhaust system is used to draw air from the points in the house where the worst air quality problems occur. It is recommended that return air ducts be installed in the bathroom, kitchen, and laundry room. Additional return air ducts from strategic locations (i.e. greenhouse, atrium, swimming pool, sauna, etc.) may be installed. The furnace return duct may be also used to exhaust from. In this method, the exhaust air is not ducted back from bathrooms, kitchens, etc to the HRV with "dedicated lines". This method has become popular and provides good ventilation when installed in accordance with the instructions. The furnace blower must be running when the HRV is operating for this method to be effective.

PRACTICAL TIPS

- For new construction, the rigid ducts are run in the walls.
- Choose the location for your Supply and Exhaust grilles. The Supply grilles should be located in every habitable room and the Exhaust Grilles should be located in the wet rooms.
- A piece of flexible ducting should be placed between the Supply Air In and Out collar of the HRV and the rigid ducting to absorb any noise or vibrations.
- For proper network of ducting, see **TYPES OF INSTALLATIONS.**
- The grilles are to be installed on the ceiling or on the wall 6" (152 mm) to 12" (305 mm) from the ceiling.

Dedicated Installation for Existing Home -

(non forced air heating / cooling system)

- 1 Begin with the duct collar marked "Exhaust Air In". Slide a short piece (12") of flexible duct over the duct collar. Using duct tape, tape the flexible duct to the collar. Run the flexible ducting to the main rigid duct trunk line, which connects to the remainder of the ducts going to and from rooms in the house. Repeat the steps for the "Supply Air Out" on the side of the HRV.
- 2 Working from a closet, attic or inside your joist wall, run the length of ducting required for the proper grille location and cut a hole in the drywall. Fasten the mounting collar (optional) to the ducting and fasten the collar to the wall or ceiling with screws.
- 3 The grille airflow can be adjusted by rotating the inside unit. It is recommended that the grilles be completely opened at first and then adjusted later as needed.

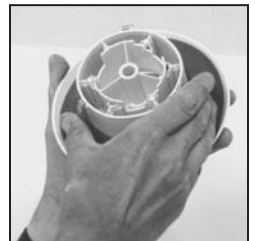

- 4 Push the grille into the optional mounting collar or directly into installed elbow.

INSTALLATION EXAMPLES

It is the responsibility of the installer to ensure all ductwork is sized and installed as designed to ensure the system will perform as intended. All air movement devices have a performance curve. The amount of air (CFM) that an HRV/ERV will deliver is directly related to the total external static pressure (E.S.P.) of the system. Static pressure is a measure of resistance imposed on the blower by length of duct work/number of fittings used in duct work, duct heater etc.

Ducting Fifth Port Units

All HRV(D)'s have a fifth duct port on top of the unit. This duct port is for both defrost and the recirculation mode. A motorized damper installed in the port closes during defrost or recirculation temporarily blocking the incoming fresh air-stream, allowing the warm air from the house to circulate through the HRV. You may wish to duct this port to a common clean air room (living room or dining room) so when recirculation is activated, household odors from the kitchen, bathroom or basement won't be introduced into the living spaces of the home environment.

RADIANT HEATED HOMES

NOTE:

The recirculation function can be accessed with a optional digital control. It allows air to move gently throughout the home without exchanging air to the outside, until needed.

Example diagram only-duct configuration may change depending on model

Fully Dedicated System (new construction)

Stale air drawn from key areas of home (bathroom, kitchen, laundry)

Fresh air supplied to main living areas

HRV must be balanced

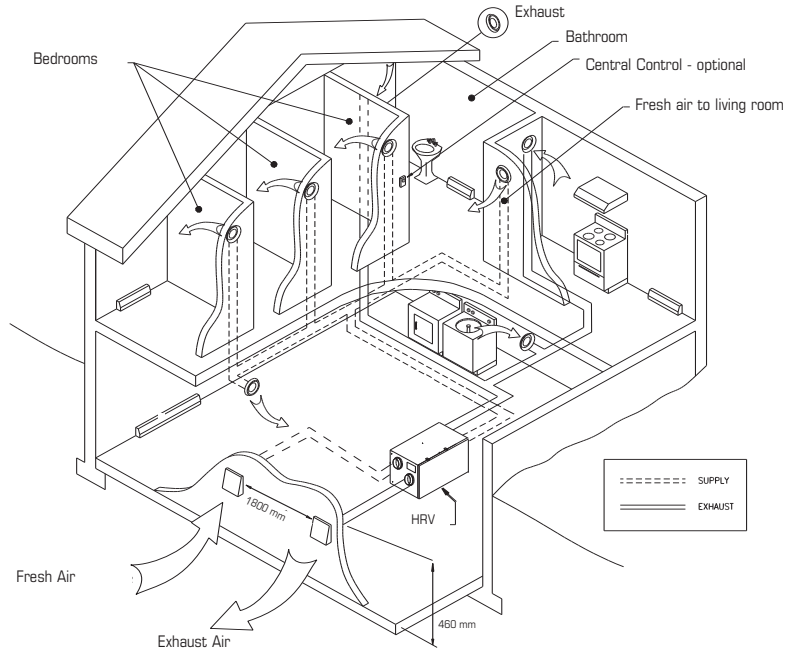

INSTALLATION EXAMPLES (CONT'D)

Example diagram only-duct configuration may change depending on model

DIRECT CONNECTION of the SUPPLY AIR STREAM to the FURNACE COLD AIR RETURN
(Stale air drawn from key areas of home)

Partially Dedicated System

Stale air drawn from key areas of home (bathroom, kitchen, laundry)

Fresh air supplied to main living areas via the forced air system.

HRV must be balanced

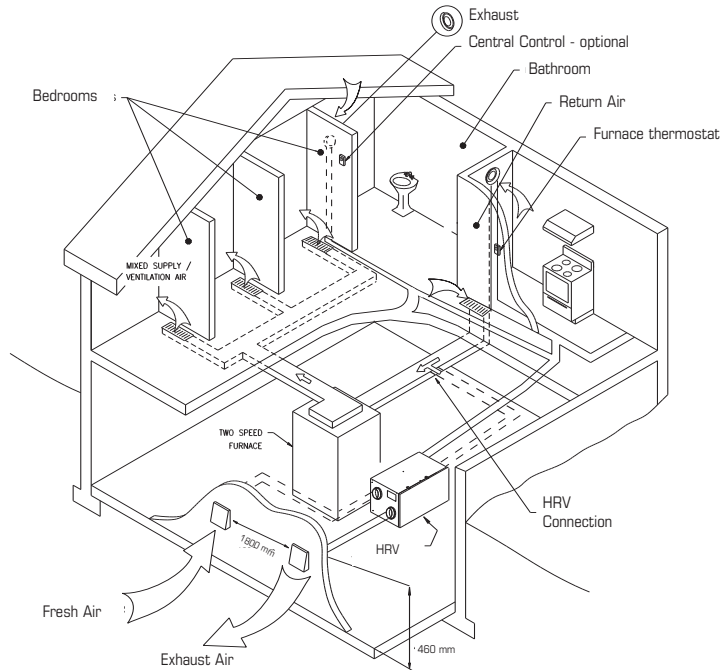

* Ducts connection may vary depending on model

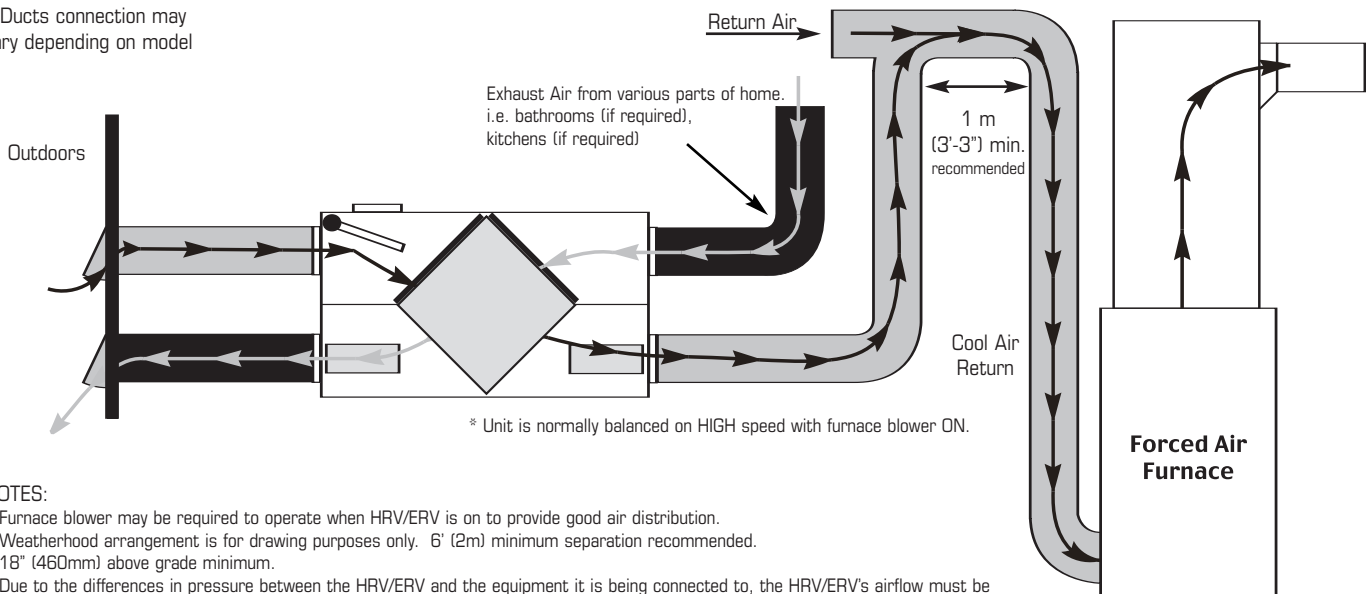

* Unit is normally balanced on HIGH speed with furnace blower ON.

NOTES:

1. Furnace blower may be required to operate when HRV/ERV is on to provide good air distribution.
2. Weatherhood arrangement is for drawing purposes only. 6' (2m) minimum separation recommended. 18" (460mm) above grade minimum.
3. Due to the differences in pressure between the HRV/ERV and the equipment it is being connected to, the HRV/ERV's airflow must be confirmed on site, using the balancing procedure found in the installation manual.

INSTALLATION EXAMPLES (CONT'D)

Example diagram only-duct configuration may change depending on model

DIRECT CONNECTION of both the HRV SUPPLY AIR STREAM and EXHAUST AIR STREAM to the FURNACE COLD AIR RETURN

Simplified Installation

Option 1 (Return/Return Method)

- HRV must be balanced
- It is mandatory that the furnace blower run continuously or HRV operation be interlocked with the furnace blower
- Check local codes/authority having jurisdiction for acceptance

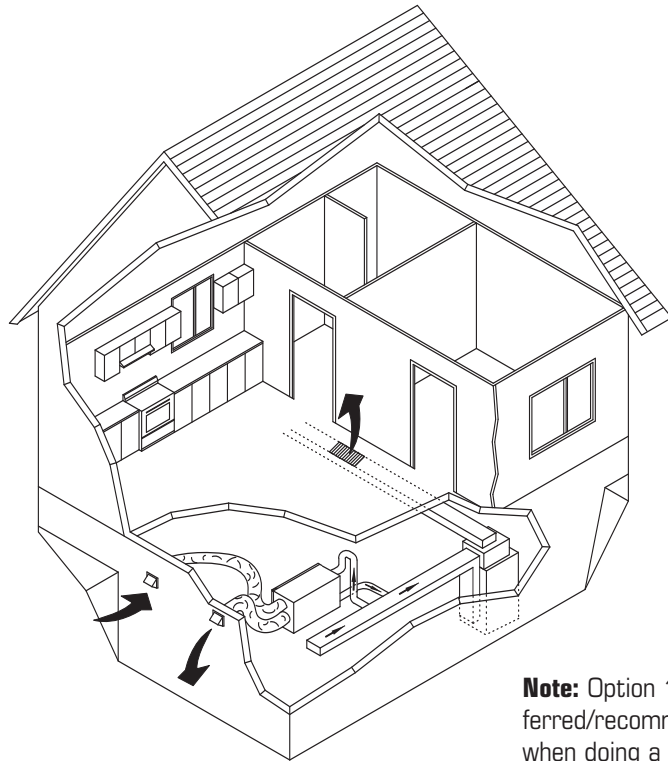

Note: Option 1 is the preferred/recommended method when doing a simplified installation

* Ducts connection may vary depending on model

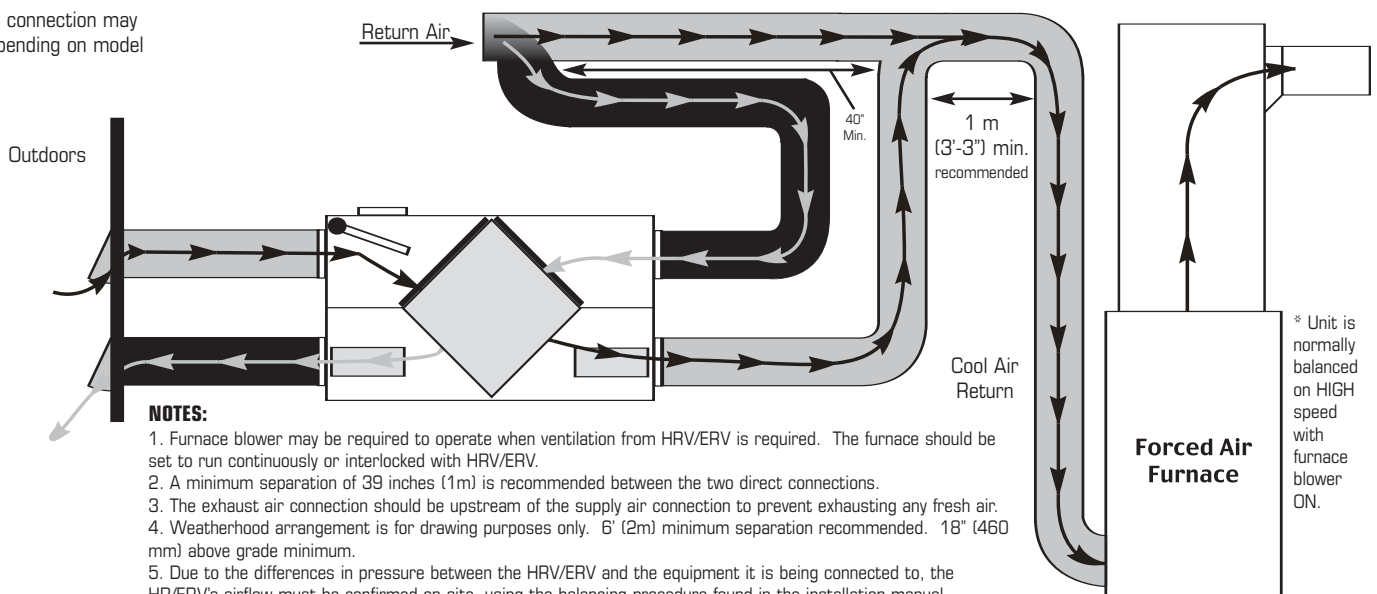

INSTALLATION EXAMPLES (CONT'D)

Example diagram only-duct configuration may change depending on model

DIRECT CONNECTION of both the HRV SUPPLY AIR STREAM & EXHAUST AIR STREAM to the FURNACE COLD AIR RETURN & SUPPLY AIR SIDE

Simplified Installation

Option 2 (Supply/Return Method)

- HRV must be balanced
- It is recommended that the furnace blower run continuously or HRV operation be interlocked with the furnace blower
- Check local codes /authority having jurisdiction for acceptance

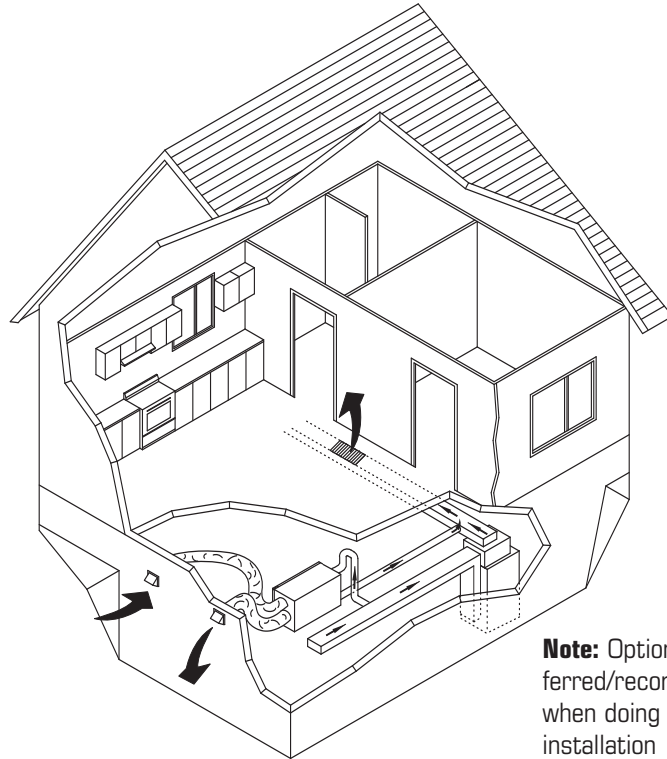

Note: Option 1 is the preferred/recommended method when doing a simplified installation

* Ducts connection may vary depending on model

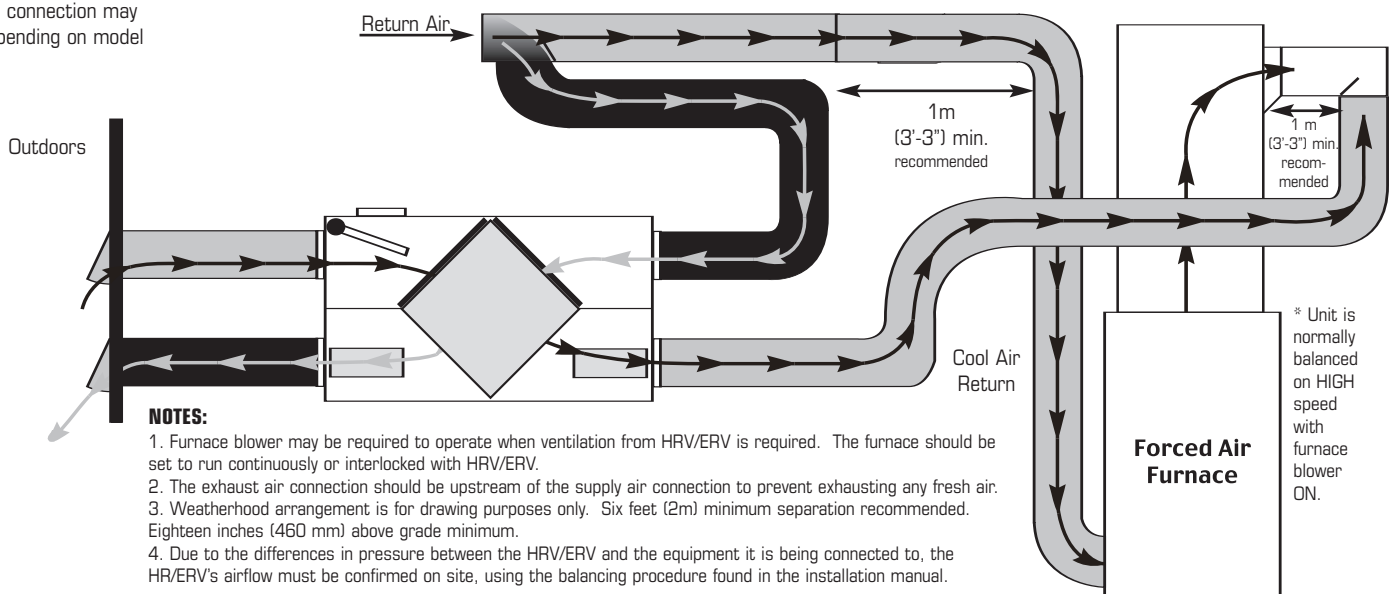

AIR FLOW BALANCING

CAUTION

- If the unit's airflows are not properly balanced...
 - The unit may not operate at its maximum efficiency.
 - Heat recovery core damage may occur.
 - The unit's use could cause negative or positive pressure in your home causing cold air to enter or other combustible equipment to backdraft.
 - The unit may not defrost properly.

PITOT TUBE BALANCING PROCEDURE

PITOT TUBE

BALANCING PROCEDURE

The following is a method of field balancing an HRV/ERV using a Pitot tube, advantageous in situations when flow stations are not installed in the ductwork. Procedure should be performed with the HRV/ERV on high speed.

The first step is to operate all mechanical systems on high speed, which have an influence on the ventilation system, i.e. the HRV/ERV itself and the forced air furnace or air handler if applicable. This will provide the maximum pressure that the HRV/ERV will need to overcome, and allow for a more accurate balance of the unit.

Drill a small hole in the duct (about 3/16), three feet downstream of any elbows or bends, and one foot upstream of any elbows or bends. These are recommended distances but the actual installation may limit the amount of straight duct.

The Pitot tube should be connected to a magnehelic gauge or other manometer capable of reading from 0 to 0.25 in. (0-62 Pa) of water, preferably to 3 digits of resolution. The tube coming out of the top of the pitot is connected to the high pressure side of the gauge. The tube coming out of the side of the pitot is connected to the low pressure or reference side of the gauge.

Insert the Pitot tube into the duct; pointing the tip into the airflow. For general balancing it is sufficient to move the pitot tube around in the duct and take an average or typical reading. Repeat this procedure in the other (supply or return) duct. Determine which duct has the highest airflow (highest reading on the gauge). Reduce this airflow using either the electronic balancing system (if applicable) or damper. The flows should now be balanced. Actual airflow can be determined from the gauge read-

ing. The value read on the gauge is called the velocity pressure. The Pitot tube comes with a chart that will give the air flow velocity based on the velocity pressure indicated by the gauge. This velocity will be in either feet per minute or meters per second. To determine the actual airflow, the velocity is multiplied by the cross sectional areas of the duct being measured.

This is an example for determining the airflow in a 6" duct. The Pitot tube reading was 0.025 inches of water.

From the chart, this is 640 feet per minute.

The 6" diameter (D) duct has cross sectional area (A) of

$$A = 3.14 \times (D/24)^2$$

$$A = 3.14 \times (6/24)^2$$

$$A = 0.196 \text{ or about } 0.2 \text{ ft}^2$$

The airflow is then: 640 ft/min x 0.2 ft² = 128 cfm

For your convenience, the cross sectional area of some common round duct is listed below:

DUCT DIAM. (inches)	CROSS SECTION AREA (sq ft.)
5	0.14
6	0.20
7	0.27
8	0.35

The accuracy of the airflow reading will be affected by how close to any elbows or bends the readings are taken. Accuracy can be increased by taking an average of multiple readings as outlined in the literature supplied with the Pitot tube.

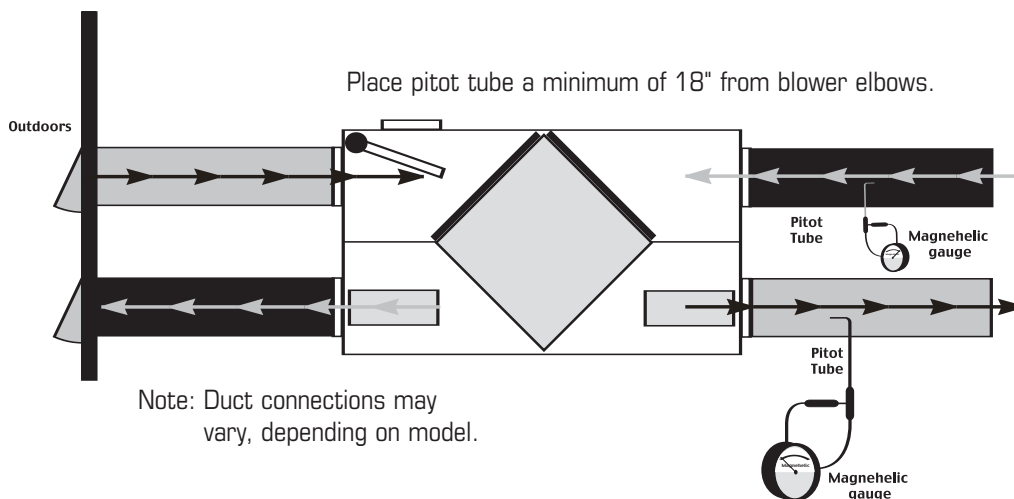

* Pitot tube should be kept at least 12" away from fans elbows and dampers to ensure accurate reading.

* A calibration decal is included to place over electronic balancing system adjustments after it has been balanced.

- The balancing procedure consists of measuring the exhaust air leaving the system and the supply air entering the system and ensuring that these two are equal. A deviation of 10% or less is acceptable. In such cases, it is recommended to have a greater amount of exhaust air than supply air as so to increase the supply air's temperature.

AIR FLOW BALANCING (CONT'D)

AIRFLOW STATION (GRID) METHOD

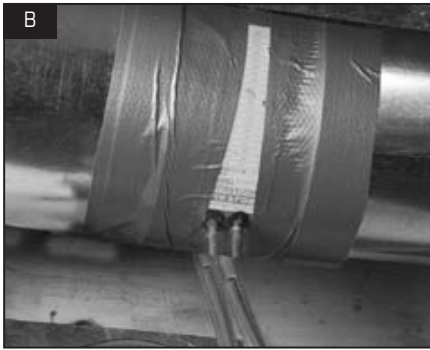

1 For this flow measuring station, cut the duct and place the flow measuring station between each station. Make sure that the flow measuring station's air direction arrow points in the direction of the airflow. Secure the flow measuring station with duct tape.

2 Before taking the reading, make sure that the magnehelic gauge is level and at 0. Refer to the flow measuring station's chart to determine your unit's airflow velocity.

3 Adjust the "Supply Air Out" damper until you reach the desired velocity. Follow the previous steps to adjust the "Exhaust Air Out" damper, if needed.

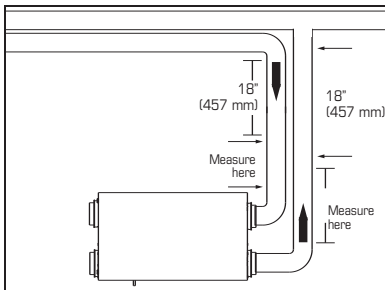

- To avoid airflow turbulence and incorrect readings, the airflow velocity should be measured on steel ducting a minimum of 18" (457 mm) from the unit or elbow and before any transition.

ADJUSTING AIRFLOWS

ELECTRONIC BALANCING MOTORS (HRV 150D & 200D only) -

Motors will be factory set at their full potential depending on speed selected.

When unit is installed you will need to balance the motors for proper operation.

Insert screwdriver and turn clockwise to slow down the motor, you will notice the motor changing speeds while performing this operation. Set to desired cfm.

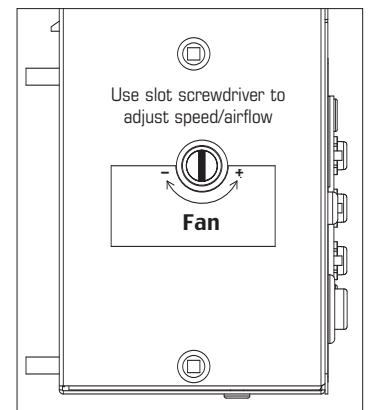

MAINTENANCE

CAUTION MAKE SURE UNIT IS UNPLUGGED BEFORE ATTEMPTING ANY MAINTENANCE WORK

The following components should also be inspected regularly and well maintained.

PRACTICAL TIPS

- To prevent electrical shock, check that the unit is unplugged before doing any repairs or maintenance.
- A yearly inspection is recommended to ensure the efficiency and trouble-free use of your system. Run through the system and verify the different operating modes.

The motor - The motors are factory balanced and lubricated for life. They require no maintenance.

The unit - The inside of the unit should be vacuumed yearly. Be careful not to damage any of the mechanical components and electrical connections.

The drain pan and drain line - Units with drain lines should have their line and connection checked regularly.

Outside hoods - The outside hoods need to be checked every season to make sure there are no leaves or insects blocking the airflow. Check regularly that there are no pollutants near the intake hood. Make sure they are clear of any snow accumulation during the winter months.

FILTERS

The filters (2) need to be checked and cleaned every three months or when they appear dirty. Wash in warm sudsy water (mild detergent) or use a soft brush vacuum. The filters should be replaced when they can no longer be cleaned properly.

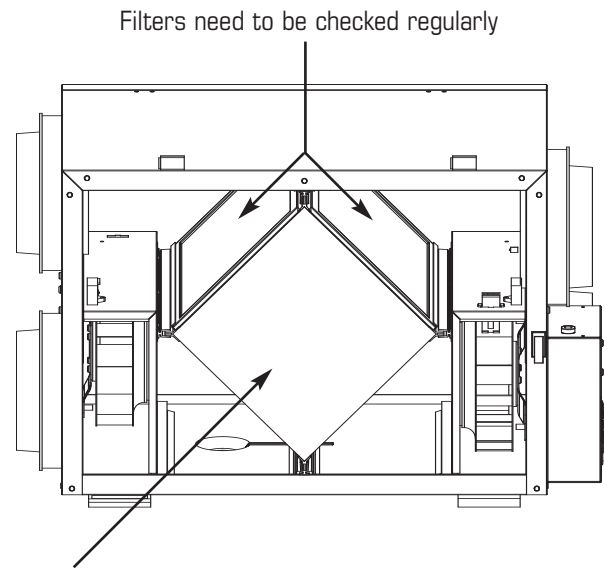

HEAT RECOVERY CORE

The heat recovery core needs to be checked and cleaned every six months. The core can be cleaned using a mild soap and water. Rinse thoroughly. Handle with care. Hot water and a strong detergent will damage the heat recovery core. It is recommended to clean the core in the summer or when the temperature is mild. Never clean the heat recovery core during winter.

Clean Core and Filters Every 3-6 Months.

Unplugged before doing any repairs or maintenance

- Open access door.
- Carefully grip ends of core and pull evenly outward. Core may be snug, but will slide out of the channel.
- Once removed from the cabinet remove filters.
- Wash core in warm soapy water (do not use dishwasher).
- Install the clean filters.
- Install clean core.

To Install the Clean Core and Filters.

- First mount the bottom flange of the core guide into the bottom channel approximately 1/4" (6mm).
- Mount the left or right side flange of the core guide approximately 1/4" (6mm) followed by the other side.
- Mount the top flange of the core guide into the top channel approximately 1/4" (6mm).
- With all four corners in place and the core straight and even, push hard in the center of the core until the core stops on the back of the cabinet.

NOTE: Some products may not be exactly as illustrated in Installation, Operation and Maintenance manual.

TROUBLESHOOTING

Problem	Causes	Solutions
Air is too dry	Dehumidistat control is set too low HRV out of balance	Increase the desired level of humidity. Change ventilation mode from continuous mode to standby. Balance HRV
Air is too humid	Dehumidistat control is set too high Sudden change in temperature Storing too much wood for heating Dryer vent exhaust is inside home Poor air circulating near windows HRV out of balance Well sealed basement door is closed	Reduce the desired level of humidity. Combine this step with use of continuous exchange mode. Wait until outside temperature stabilizes (winter). Heating will also improve situation. Store a majority of your wood outside. Even dried, a cord of wood contains more than 20 gallons of water. Arrange outside vent for dryer. Open curtains or blinds. Bay or bow windows may require mechanical method. Balance HRV Open the door or install a grill on the door.
Persistent condensation on window	Improper adjustment of dehumidistat control HRV out of balance	Reduce the desired level of humidity. Combine this with the use of continuous exchange mode. Balance HRV
Poor Air Flows	-1/4" (6mm) mesh on the outside hoods is plugged -Filters plugged -Core obstructed -House grilles closed or blocked -Dampers are closed if installed -Poor power supply at site -Ductwork is restricting HRV/ERV -Improper speed control setting -HRV/ERV airflow improperly balanced	-Clean exterior hoods or vents -Remove and clean filter -Remove and clean core -Check and open grilles -Have electrician check supply voltage at house -Check duct installation -Increase the speed of the HRV/ERV -Have contractor balance HRV/ERV
Supply air feels cold	-Poor location of supply grilles, the airflow may irritate the occupant -Outdoor temperature extremely cold	-Locate the grilles high on the walls or under the baseboards, install ceiling mounted diffuser or grilles so as not to directly spill the supply air on the occupant (eg. Over a sofa) -Turn down the HRV/ERV supply speed. A small duct heater (1kw) could be used to temper the supply air -Placement of furniture or closed doors is restricting the movement of air in the home -If supply air is ducted into furnace return, the furnace fan may need to run continuously to distribute ventilation air comfortably
HRV and / or Ducts Frosting up	-HRV air flows are improperly balanced -Malfunction of the HRV defrost system	-Note: minimal frost build-up is expected on cores before unit initiates defrost cycle functions -Have HVAC contractor balance the HRV
Condensation or Ice Build Up in Insulated Duct to the Outside	-Incomplete vapor barrier around insulated duct -A hole or tear in outer duct covering	-Tape and seal all joints -Tape any holes or tears made in the outer duct covering -Ensure that the vapor barrier is completely sealed.

ELECTRICAL CONNECTIONS

Low Voltage Control Wiring Connections

* Please see instruction on individual controls for proper wiring and set up of control selected.

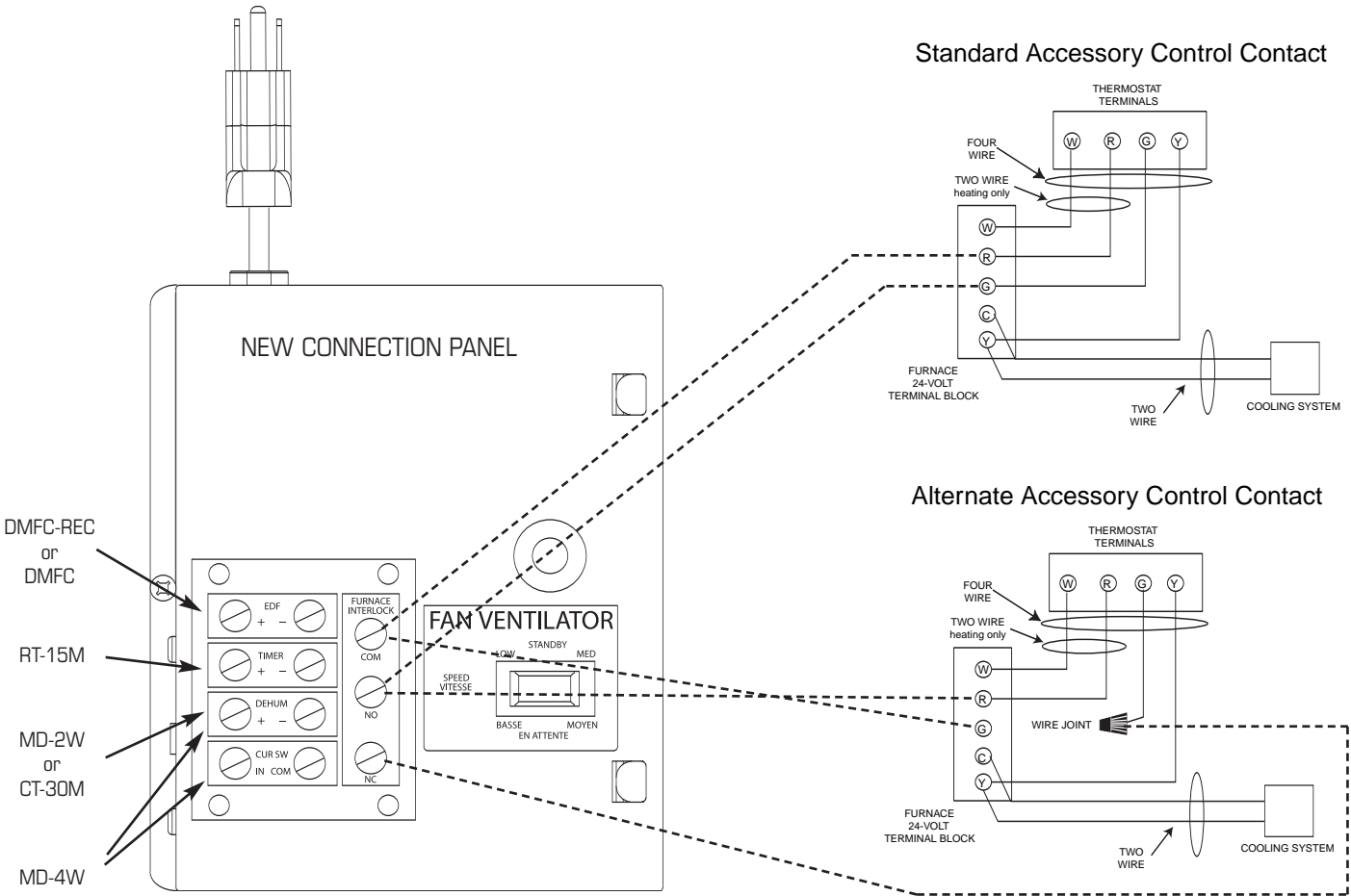

DMFC-REC - This control is not polarity sensitive, therefore you may connect any wire to either positive (+) or negative (-) connection.

2 wire connection



2 wire connection



MD-2W - Connect to positive (+) and negative (-) connections on electrical panel.

2 wire connection



DMFC - This control is not polarity sensitive, therefore you may connect any wire to either positive (+) or negative (-) connection.

2 wire connection

RT-15M - Connect to positive (+) and negative (-) connections on electrical panel.



MD-4W - Connect to positive (+) and negative (-) connections on electrical panel.

4 wire connection

Also connect to CUR SW

ELECTRICAL CONNECTIONS (CONT'D)

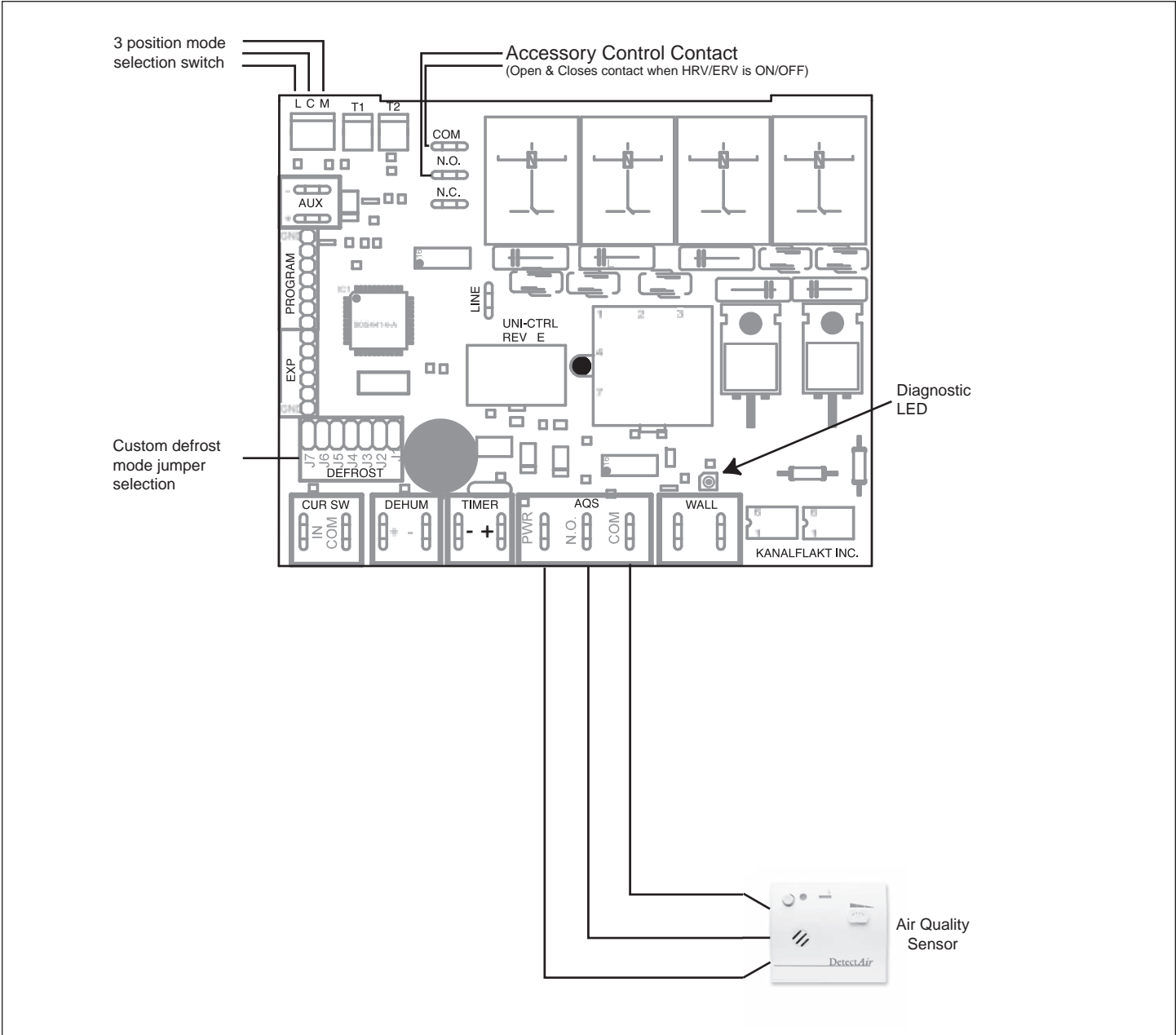

United States
1712 Northgate Blvd.,
Sarasota, FL. 34234
Phone: 800.747.1762;
941.309.6000
Fax: 800.487.9915; 941.309.6099
www.fantech.net; info@fantech.net

Canada
50 Kanalfakt Way,
Bouctouche, NB E4S 3M5
Phone: 800.565.3548;
506.743.9500
Fax: 877.747.8116; 506.743.9600
www.fantech.ca; info@fantech.ca

The product is manufactured by Fantech, Inc. Fantech reserves the right to modify, at any time and without notice, any or all of this product's features, designs, components and specifications.

Item #: 402950 Rev. 1
Rev Date: 11022006