

SONY®

3-077-370-11(2)

CD/DVD Player

Operating Instructions



DVP-F25

© 2002 Sony Corporation

WARNING

To prevent fire or shock hazard, do not expose the unit to rain or moisture. To avoid electrical shock, do not open the cabinet. Refer servicing to qualified personnel only.

CAUTION

The use of optical instruments with this product will increase eye hazard. As the laser beam used in this CD/DVD player is harmful to eyes, do not attempt to disassemble the cabinet.

Refer servicing to qualified personnel only.

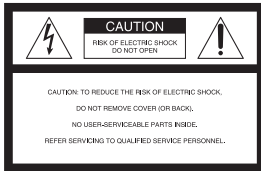

This symbol is intended to alert the user to the presence of uninsulated “dangerous voltage”

within the product’s enclosure that may be of sufficient magnitude to constitute a risk of electric shock to persons.



This symbol is intended to alert the user to the presence of important operating and

maintenance (servicing) instructions in the literature accompanying the appliance.

The following caution label is located on the laser protective housing inside the enclosure.



CAUTION:

TO PREVENT ELECTRIC SHOCK, MATCH WIDE BLADE OF PLUG TO WIDE SLOT, FULLY INSERT.

For customers in the U.S.A.

Owner’s Record

The model and serial numbers are located at the bottom of the unit. Record the serial number in the space provided below. Refer to them whenever you call upon your Sony dealer regarding this product.

Model No. DVP-F25

Serial No. _____

CAUTION

You are cautioned that any change or modifications not expressly approved in this manual could void your authority to operate this equipment.

Note

This equipment has been tested and found to comply with the limits for a Class B digital device, pursuant to Part 15 of the FCC Rules. These limits are designed to provide reasonable protection against harmful interference in a residential installation. This equipment generates, uses, and can radiate radio frequency energy and, if not installed and used in accordance with the instructions, may cause harmful interference to radio communications. However, there is no guarantee that interference will not occur in a particular installation. If this equipment does cause harmful interference to radio or television reception, which can be determined by turning the equipment off and on, the user is encouraged to try to correct the interference by one or more of the following measures:

- Reorient or relocate the receiving antenna.
- Increase the separation between the equipment and receiver.
- Connect the equipment into an outlet on a circuit different from that to which the receiver is connected.
- Consult the dealer or an experienced radio/TV technician for help.

Welcome!

Thank you for purchasing this Sony CD/DVD Player. Before operating this player, please read this manual thoroughly and retain it for future reference.

Precautions

On safety

- Caution – The use of optical instruments with this product will increase eye hazard.
- To prevent fire or shock hazard, do not place objects filled with liquids, such as vases, on the apparatus.
- Should any solid object or liquid fall into the cabinet, unplug the player and have it checked by qualified personnel before operating it any further.

On power sources

- The player is not disconnected from the AC power source as long as it is connected to the wall outlet, even if the player itself has been turned off.
- If you are not going to use the player for a long time, be sure to disconnect the player from the wall outlet. To disconnect the AC power cord, grasp the plug itself; never pull the cord.
- Should the AC power cord need to be changed, have it done at a qualified service shop only.

On placement

- Place the player in a location with adequate ventilation to prevent heat build-up in the player.
- Do not place the player on a soft surface such as rug that might block the ventilation holes.
- Do not place the player in a location near heat sources, or in a place subject to direct sunlight, excessive dust, or mechanical shock.
- Keep the player and discs away from equipment with strong magnets, such as microwave ovens, or large loudspeakers.
- Do not place heavy objects on the player.
- Do not install the appliance in a confined space, such as bookcase or built-in cabinet.

On operation

- If the player is brought directly from a cold to a warm location, or is placed in a very damp room, moisture may condense on the lenses inside the player. Should this occur, the player may not operate properly. In this case, remove the disc and leave the player

turned on for about half an hour until the moisture evaporates.

- Do not insert a disc with non-standard shape (e.g., card, heart) into the player. The disc may not be ejected and cause a malfunction.
- When you move the player, take out any discs. If you don't, the disc may be damaged.

On adjusting volume

Do not turn up the volume while listening to a section with very low level inputs or no audio signals. If you do, the speakers may be damaged when a peak level section is played.

On cleaning

Clean the cabinet, panel, and controls with a soft cloth slightly moistened with a mild detergent solution. Do not use any type of abrasive pad, scouring powder or solvent such as alcohol or benzine.

On cleaning discs

Do not use a commercially available cleaning disc. It may cause a malfunction.

IMPORTANT NOTICE

Caution: This player is capable of holding a still video image or on-screen display image on your television screen indefinitely. If you leave the still video image or on-screen display image displayed on your TV for an extended period of time, you risk permanent damage to your television screen. Projection televisions are especially susceptible to this.

If you have any questions or problems concerning your player, please consult your nearest Sony dealer.

Table of Contents

WARNING	2
Welcome!	2
Precautions	3
About this Manual	6
This Player Can Play the Following Discs	6
Notes about the Discs	7
Index to Parts and Controls	8
Guide to On-Screen Displays (Control Bar)	11
<hr/>	
Simple Start Guide	13
Quick Overview	13
Step 1: Unpacking	13
Step 2: Inserting Batteries into the Remote	13
Step 3: TV Hookups	14
Step 4: Playing a Disc	15
<hr/>	
Hookups	16
Hooking Up the Player	16
Step 1: Connecting the Video Cords	16
Step 2: Connecting the Audio Cords	18
Step 3: Attaching the Jack Cover and Stand	23
Step 4: Connecting the Power Cord	25
Step 5: Quick Setup	25
<hr/>	
Playing Discs	28
Playing Discs	28
Searching for a Particular Point on a Disc (Scan, Slow-motion Play)	30
Resuming Playback from the Point Where You Stopped the Disc (Multi-disc Resume)	31
Using the DVD's Menu	32
Playing VIDEO CDs with PBC Functions (PBC Playback)	33
Playing an MP3 Audio Track	34
Various Play Mode Functions (Program Play, Shuffle Play, Repeat Play, A-B Repeat Play)	36
<hr/>	
Searching for a Scene	42
Searching for a Title/Chapter/Track/Index/Scene (Search mode)	42
<hr/>	
Viewing Information About the Disc	43
Checking the Playing Time and Remaining Time	43
<hr/>	
Sound Adjustments	45
Changing the Sound	45
TV Virtual Surround Settings (TVS)	46

Enjoying Movies	48
Changing the Angles	48
Displaying the Subtitles	48
Adjusting the Picture Quality (BNR)	49
Adjusting the Playback Picture (CUSTOM PICTURE MODE)	50
Enhancing the Playback Picture (DIGITAL VIDEO ENHANCER)	51





Using Various Additional Functions	52
Locking Discs (CUSTOM PARENTAL CONTROL, PARENTAL CONTROL)	52
Controlling Your TV with the Supplied Remote	56

Settings and Adjustments	58
Using the Setup Display	58
Setting the Display or Sound Track Language (LANGUAGE SETUP)	59
Settings for the Display (SCREEN SETUP)	60
Custom Settings (CUSTOM SETUP)	61
Settings for the Sound (AUDIO SETUP)	62

Additional Information	64
Troubleshooting	64
Self-diagnosis Function (When letters/numbers appear in the display)	66
Glossary	66
Specifications	68
Language Code List	69
Index	70



About this Manual

- Instructions in this manual describe the controls on the remote. You can also use the controls on the player if they have the same or similar names as those on the remote.
- The meaning of the icons used in this manual is described below:

Icon	Meaning
	Functions available for DVD VIDEOS or DVD-Rs/DVD-RWs in video mode
	Functions available for VIDEO CDs or CD-Rs/CD-RWs in video CD format
	Functions available for DATA CDs (CD-ROMs/CD-Rs/CD-RWs containing MP3* audio tracks)
	Functions available for music CDs or CD-Rs/CD-RWs in music CD format

* MP3 (MPEG1 Audio Layer 3) is a standard format defined by ISO (International Standard Organization)/MPEG which compresses audio data.

This Player Can Play the Following Discs

Format of discs	
DVD VIDEO	
VIDEO CD	
Music CD	

The “DVD VIDEO” logo is a trademark.

Region code

Your player has a region code printed on the bottom of the unit and only will play DVD VIDEO discs (playback only) labeled with identical region codes. This system is used to protect copyrights.

DVDs labeled  will also play on this player.

If you try to play any other DVD, the message “Playback prohibited by area limitations.” will appear on the TV screen. Depending on the DVD, no region code indication may be labeled even though playing the DVD is prohibited by area restrictions.



Example of discs that the player cannot play

The player cannot play the following discs:

- All CD-ROMs (including PHOTO CDs)/CD-Rs/CD-RWs other than those recorded in the following formats:
 - music CD format
 - video CD format
 - MP3 format that conforms to ISO9660* Level 1/Level 2, or its extended format, Joliet
 - Data part of CD-Extras
 - DVD-RWs in VR mode
 - DVD-ROMs
 - DVD Audio discs
 - HD layer on Super Audio CDs
- * A logical format of files and folders on CD-ROMs defined by ISO (International Standard Organization).

Also, the player cannot play the following discs:

- A DVD with a different region code.
- A disc recorded in a color system other than NTSC, such as PAL or SECAM (this player conforms to the NTSC color system).
- A disc that has a non-standard shape (e.g., card, heart).
- A disc with paper or stickers on it.
- A disc that has the adhesive of cellophane tape or a sticker still left on it.

Note

Some CD-Rs, CD-RWs, DVD-Rs, or DVD-RWs (in video mode) cannot be played on this player due to the recording quality or physical condition of the disc, or the characteristics of the recording device. Furthermore, the disc will not play if it has not been

correctly finalized. For more information, see the operating instructions for the recording device. Note that discs created in the Packet Write format cannot be played.

Note on playback operations of DVDs and VIDEO CDs

Some playback operations of DVDs and VIDEO CDs may be intentionally set by software producers. Since this player plays DVDs and VIDEO CDs according to the disc contents the software producers designed, some playback features may not be available. Also, refer to the instructions supplied with the DVDs or VIDEO CDs.

Copyrights

This product incorporates copyright protection technology that is protected by method claims of certain U.S. patents, other intellectual property rights owned by Macrovision Corporation, and other rights owners. Use of this copyright protection technology must be authorized by Macrovision Corporation, and is intended for home and other limited viewing uses only unless otherwise authorized by Macrovision Corporation. Reverse engineering or disassembly is prohibited.

Notes about the Discs

- To keep the disc clean, handle the disc by its edge. Do not touch the surface.



- Do not expose the disc to direct sunlight or heat sources such as hot air ducts, or leave it in a car parked in direct sunlight as the temperature may rise considerably inside the car.
- After pressing  on the player to eject the disc, do not leave the disc as it is. Remove it completely from the player.
- After playing, store the disc in its case.
- If glue is present on the outer edge of the disc, wipe the edge of the disc with the side

of a pen or pencil so that the glue is spread evenly along the edge before inserting the disc into the player. Be sure not to touch the playback side of the disc when wiping the edge.

- If burrs remain on the outer edge of the disc, remove them by rubbing with the side of a pen or pencil. If burrs are not removed, discs may not load properly into the player, or fragments of plastic adhering to the playback side of the disc may cause skipping in the sound.
- Clean the disc with a cleaning cloth. Wipe the disc from the center out.



- Do not use solvents such as benzene, thinner, commercially available cleaners, or anti-static spray intended for vinyl LPs.

Index to Parts and Controls

For more information, refer to the pages indicated in parentheses.

Front panel

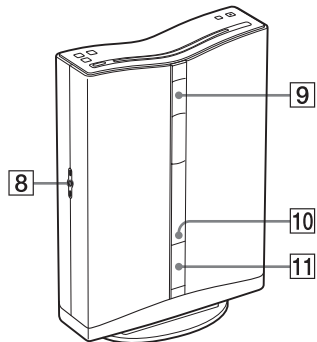
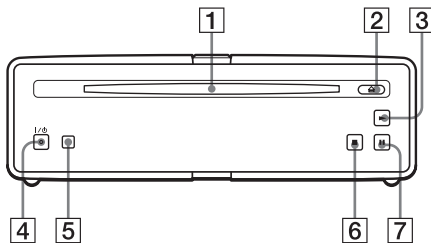

- | | |
|-------------------------------------------------------------------------------------------------------------------------------------------------------------------|------------------------------------------------------------------------|
| 1 Disc slot (28) | 6 ■ (stop) button (29) |
| 2 ≡ (eject) button (29) | 7 (pause) button (29) |
| 3 ▶ (playback) button (28) | 8 Screw hole for the stand (24) |
| 4 I/⏻ (on/standby) button/indicator (28)
The indicator lights up in green when the power is on and lights up in red when the player is in standby mode. | 9 Disc window (28) |
| 5 □ (remote sensor) (13) | 10 □ (remote sensor) (13) |
| | 11 Illumination (61)
Lights up in blue when the power is on. |

Rear panel

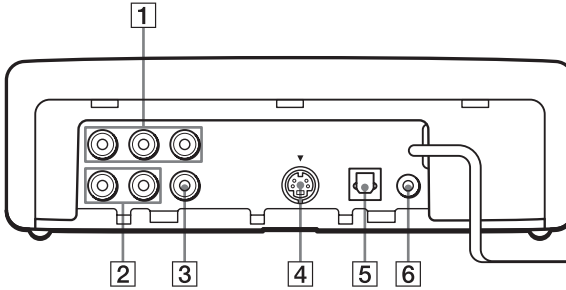

1 COMPONENT VIDEO OUT (Y, Pb, Pr) jacks (16)

2 AUDIO OUT L/R jacks (19) (20) (21)

3 VIDEO OUT jack (16)

4 S VIDEO OUT jack (16)

5 DIGITAL OUT (OPTICAL) jack (20) (21) (22)

6 CONTROL S IN jack (16)

To remove the jack cover

The player is sold with the jack cover attached. Press both of the parts marked with  to remove the jack cover. You will find the jacks and the power cord illustrated above.

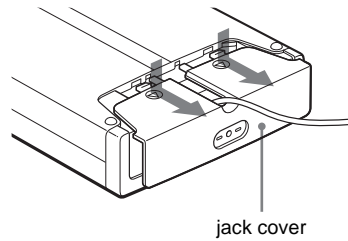

Remote

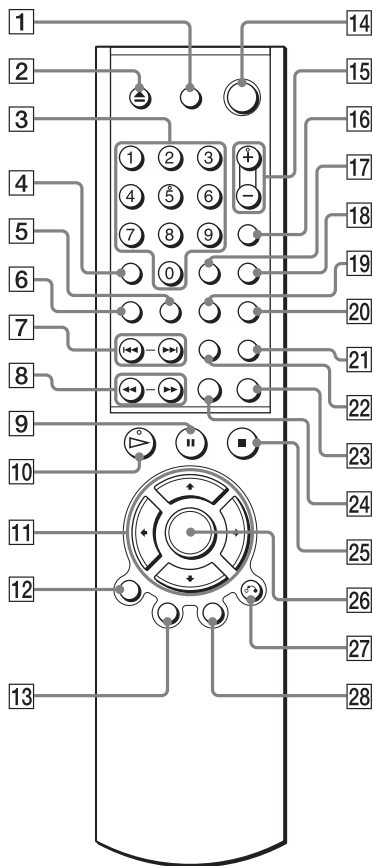

- 1** TV \mathbb{I}/O (on/standby) button (56)
- 2** \blacktriangle EJECT button (29)
- 3** Number buttons (32)
The number 5 button has a tactile dot.*
- 4** CLEAR button (36)
- 5** SUBTITLE button (48)
- 6** AUDIO button (45)
- 7** \lll/\ggg PREV/NEXT (previous/next) buttons (29)
- 8** $\lll \lll/\ggg \ggg$ SCAN/SLOW buttons (30)
- 9** || PAUSE button (29)
- 10** \triangleright PLAY button (28)
The \triangleright button has a tactile dot.*
- 11** $\leftarrow/\uparrow/\downarrow/\rightarrow$ buttons (32)
- 12** DISPLAY button (11)
- 13** TOP MENU button (32)
- 14** \mathbb{I}/O (on/standby) button (28)
- 15** VOL (volume) +/- buttons (56)
The + button has a tactile dot.*
- 16** TV/VIDEO button (56)
- 17** ENTER button (30)
- 18** PICTURE MODE button (50)
- 19** ANGLE button (48)
- 20** SUR (surround) button (46)
- 21** TIME/TEXT button (43)
- 22** REPEAT button (39)
- 23** REPLAY button (29)
- 24** SEARCH MODE button (42)
- 25** \blacksquare STOP button (29)
- 26** ENTER button (30)
- 27** \curvearrowright RETURN button (33)
- 28** MENU button (32) (34)

* Use the tactile dot as a reference when operating the player.

Guide to On-Screen Displays (Control Bar)

The following explains the Control Bar. The Control Bar is used for making adjustments to the settings or displaying information during playback.

The displayed contents differ according to the type of disc being played. The numbers in parentheses indicate reference pages.

Displaying the Control Bar during playback

The following displays appear when the DISPLAY button is pressed repeatedly during playback. You can select the setting that suits the current playback item and view the related information.

◆Display 1

The following play modes ①~④ can be set. The indicator lights up in blue when activated. Example: When Repeat Play is selected. (The display will differ when A-B Repeat Play is set.)

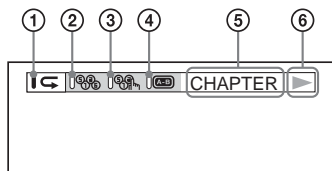

- ① Repeat Play (39)
- ② Shuffle Play (38)
- ③ Program Play (36)
- ④ A-B Repeat Play (40)
- ⑤ Unit being repeated in this example.
- ⑥ Playback status (▶ Playback, ■■ Pause, ■ Stop, etc.)



◆Display 2

The following play modes ⑦~⑪ can be set. The indicator lights up in blue when activated. Example: When “TVS” is set.

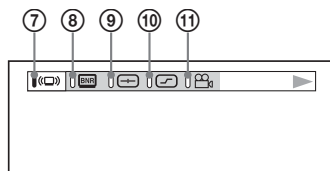

- ⑦ TVS (46)
- ⑧ “BNR” (49)
- ⑨ “CUSTOM PICTURE MODE” (50)
- ⑩ “DIGITAL VIDEO ENHANCER” (51)
- ⑪ “ANGLE” (48)

The indicator lights up in blue when various angles are recorded on the scene.



◆Display 3

The following playback information is displayed.

Example: When playing a DVD.

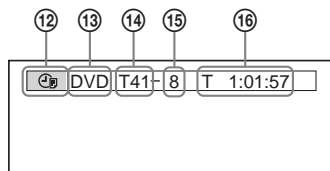

- ⑫ TIME/TEXT icon (43)
- ⑬ Disc type
- ⑭ Title number of the DVD (43)
- ⑮ Chapter number of the DVD (43)
- ⑯ Playing time or remaining time (43)



◆Display 4 (DVD playback only)

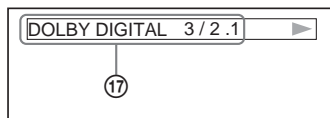

- ⑰ Format of the current audio signal (45)



◆No display



◆Return to Display 1

Displaying the Control Bar in stop mode

The following displays appear when the DISPLAY button is repeatedly pressed during stop mode. You can make basic adjustments and customize the player to suit your viewing preferences.

◆Display 1

The following settings can be made.

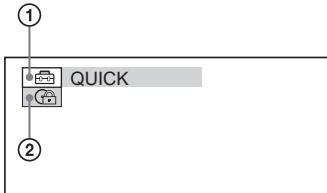

① SETUP (58)

- Select QUICK to make the minimum number of basic adjustments for using the player.
- Select CUSTOM to make a full range of adjustments.
- Select RESET to return the SETUP adjustments to the default settings.

② PARENTAL CONTROL (52)

- Set this to limit the playback of selected discs on this player.



◆Display 2

Shows the same information as Display 1 during playback.

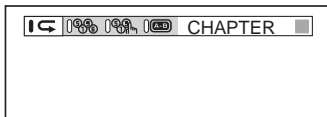

◆Display 3

Shows the same information as Display 2 during playback.



◆Display 4

Shows the same information as Display 3 during playback.

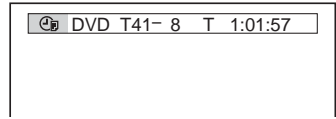

◆No display



◆Return to Display 1

Simple Start Guide

Quick Overview

A quick overview presented in this guide will give you enough information to start using the player for your enjoyment. To use the surround sound features of this player, refer to “Hookups” on page 16.

Notes

- You cannot connect this player to a TV that does not have a video input jack.
- Be sure to disconnect the power of each component before connecting.

Step 1: Unpacking

Check that you have the following items:

- Audio/video cord (pinplug × 3 ↔ pinplug × 3) (1)
- Remote commander (remote) (1)
- Size AA (R6) batteries (2)
- Stand (1)
- Screw (1)

Step 2: Inserting Batteries into the Remote

You can control the player using the supplied remote. Insert two Size AA (R6) batteries by matching the ⊕ and ⊖ ends on the batteries to the markings inside the compartment. When using the remote, point it at the remote sensor  on the player.

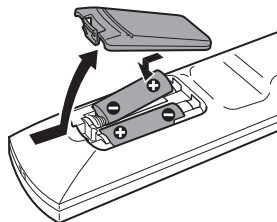

Notes

- Do not leave the remote in an extremely hot or humid place.
- Do not drop any foreign object into the remote casing, particularly when replacing the batteries.
- Do not expose the remote sensor to direct light from the sun or a lighting apparatus. Doing so may cause a malfunction.
- If you do not use the remote for an extended period of time, remove the batteries to avoid possible damage from battery leakage and corrosion.

Step 3: TV Hookups

Remove the jack cover from the player (see fig. **A** and page 9).

Connect the supplied audio/video cord and the power cord in the order (**1**~**3**) shown below. Be sure to connect the power cord last.

After connecting the cords, attach the jack cover (page 23).

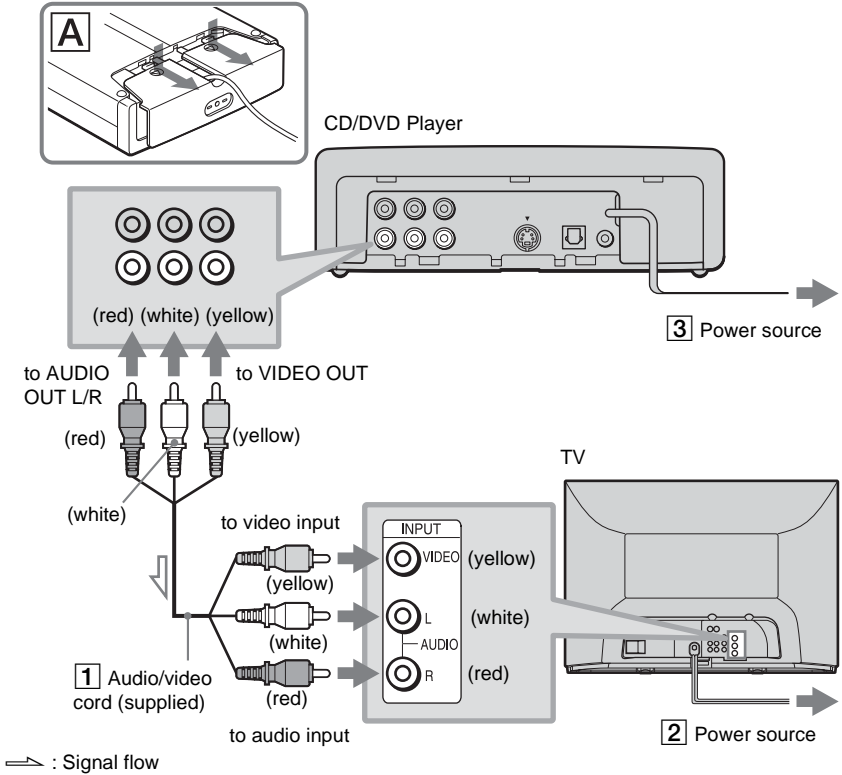

When connecting to a wide screen TV

Depending on the TV type, the image of some discs may not fit your TV screen.

If you want to change the aspect ratio, please refer to page 60.

When connecting to a monaural TV

Use a stereo-mono conversion cord (not supplied). Connect the VIDEO OUT jack on the player to the TV's video input jack, and connect the AUDIO OUT L/R jacks to the TV's audio input jack.

Step 4: Playing a Disc

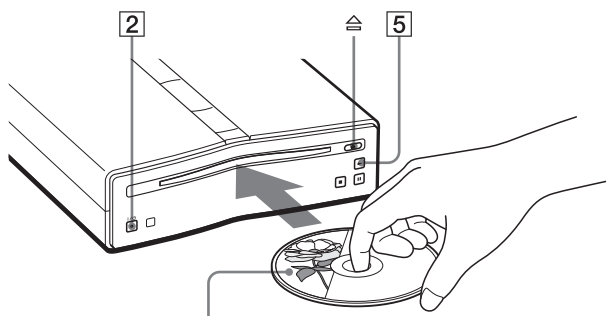

The labeled (or non-playback) side appears through the disc window.

- 1** Turn on the TV.
- 2** Press **II/⏻** on the player.
- 3** Switch the input selector on your TV so that the signal from the player appears on the TV screen.
- 4** Insert the disc in the player so that the labeled (or non-playback) side appears through the disc window.
- 5** Press **▶**.
The player begins playing the disc.

After Step 5

Depending on the disc, a menu may be displayed on the TV screen. If so, select the item you want from the menu and play the DVD (page 32) or VIDEO CD disc (page 33).

To stop playing

Press **■**.

To remove the disc

Press **⏮**.

Remove the disc from the player.

To turn off the player

Press **II/⏻**. The player enters standby mode and the power indicator lights up in red.

Hooking Up the Player

Follow Steps 1 to 5 to hook up and adjust the settings of the player.
 Before you start, disconnect the power cords, check that you have all of the supplied accessories, and insert the batteries into the remote (page 13). Remove the jack cover (page 9).

Notes

- Plug cords securely to prevent unwanted noise.
- Refer to the instructions supplied with the components to be connected.

Step 1: Connecting the Video Cords

Connect this player to your TV monitor, projector, or AV amplifier (receiver) using a video cord. Select one of the patterns **A** through **C**, according to the input jack on your TV monitor, projector, or AV amplifier (receiver).

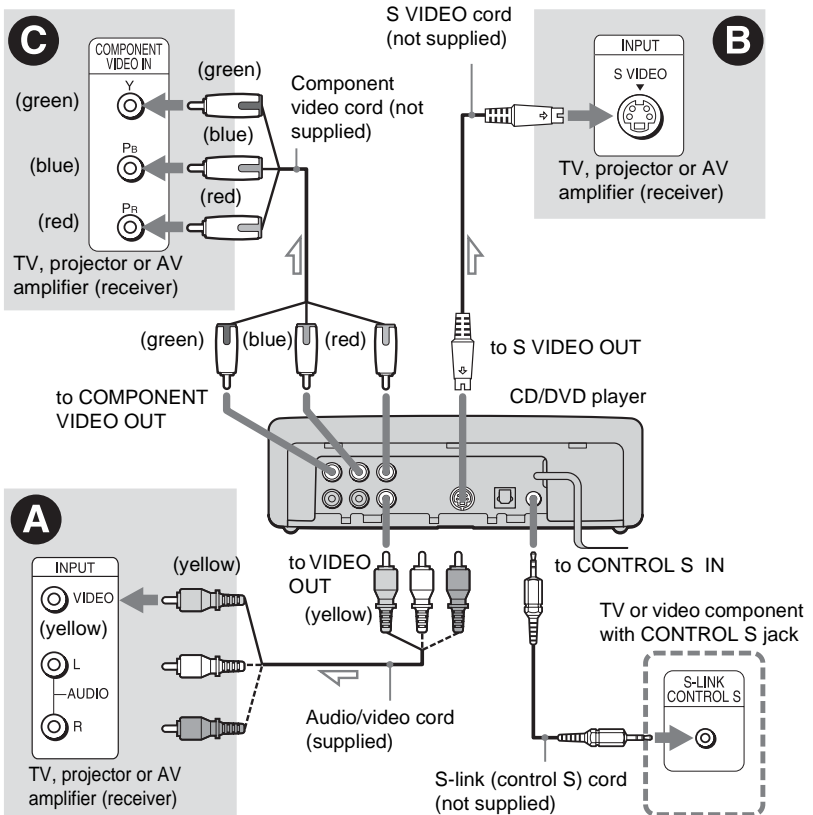

→ : Signal flow

A If you are connecting to a video input jack

Connect the yellow plug of the audio/video cord (supplied) to the yellow (video) jacks. You will enjoy standard quality images.



Use the red and white plugs to connect to the audio input jacks (page 19). (Do this if you are connecting to a TV only.)

B If you are connecting to an S VIDEO input jack

Connect an S VIDEO cord (not supplied). You will enjoy high quality images.



C If you are connecting to a monitor, projector, or AV amplifier (receiver) having component video input jacks (Y, P_B, P_R)

Connect the component via the COMPONENT VIDEO OUT jacks using a component video cord (not supplied) or three video cords (not supplied) of the same kind and length. You will enjoy accurate color reproduction and high quality images.



If your TV or video component has an S-LINK (CONTROL S) connector

You can control the player by pointing the remote at the remote sensor on the TV or video component. This feature is convenient when you placed the player and the TV or video component away from each other. Connect the TV or video component via the CONTROL S IN connectors using the S-link (control S) cord (not supplied). Refer to the instructions supplied with the component to be connected.



Note

Connect the player directly to the TV. If you pass the player signals via the VCR, etc., you may not receive a clear image on the TV screen.

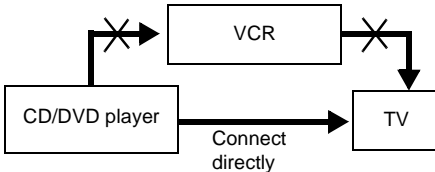

Step 2: Connecting the Audio Cords

Refer to the chart below to select the connection that best suits your system. Be sure to also read the instructions for the components you wish to connect.

Select a connection

Select one of the following connections, **A** through **D**.

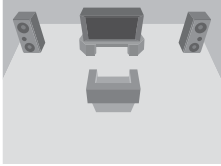
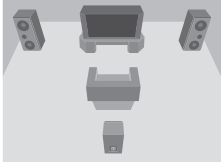
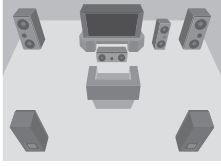
Components to be connected	Connection	Your setup
TV <ul style="list-style-type: none"> Surround effects: TVS DYNAMIC (page 47), TVS WIDE (page 47) 	A (page 19)	Example 
Stereo amplifier (receiver) and two speakers <ul style="list-style-type: none"> Surround effects: TVS STANDARD (page 47) or MD deck/DAT deck <ul style="list-style-type: none"> Surround effects: none 	B (page 20)	Example 
AV amplifier (receiver) having a Dolby* Surround (Pro Logic) decoder and 3 to 6 speakers <ul style="list-style-type: none"> Surround effects: Dolby Surround (Pro Logic) (page 62) 	C (page 21)	Example 
AV amplifier (receiver) with a digital input jack having a Dolby Digital, or DTS** decoder and 6 speakers <ul style="list-style-type: none"> Surround effects: Dolby Digital (5.1ch) (page 63), DTS (5.1ch) (page 63) 	D (page 22)	Example 

* Manufactured under license from Dolby Laboratories. "Dolby," "Pro Logic," and the double-D symbol are trademarks of Dolby Laboratories.

** "DTS" and "DTS Digital Out" are trademarks of Digital Theater Systems, Inc.

A Connecting to your TV

This connection will use your TV speakers for sound.

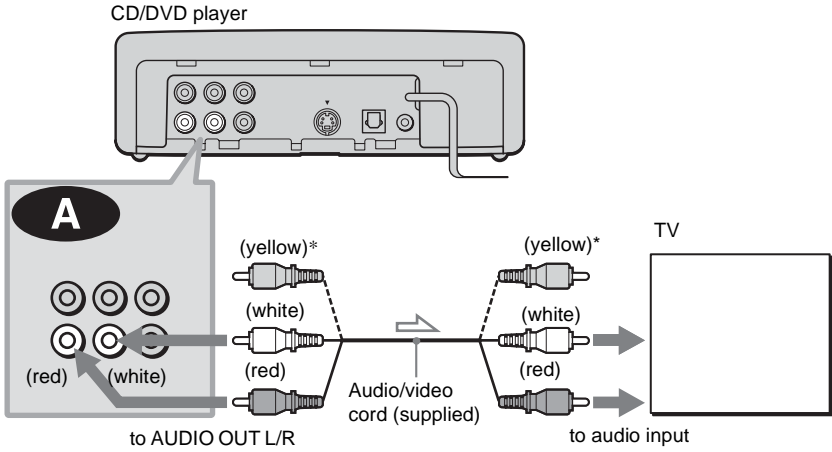

⇒ : Signal flow

* The yellow plug is used for video signals (page 16).

Hint

When connecting to a monaural TV, use a stereo-mono conversion cord (not supplied). Connect the AUDIO OUT L/R jacks to the TV's audio input jack.

B Connecting to a stereo amplifier (receiver) and 2 speakers/Connecting to an MD deck or DAT deck

If the stereo amplifier (receiver) has audio input jacks L and R only, use **B-1**. If the amplifier (receiver) has a digital input jack, or when connecting to an MD deck or DAT deck, use **B-2**. In this case, you can also connect the player directly to the MD deck or DAT deck without using your stereo amplifier (receiver).

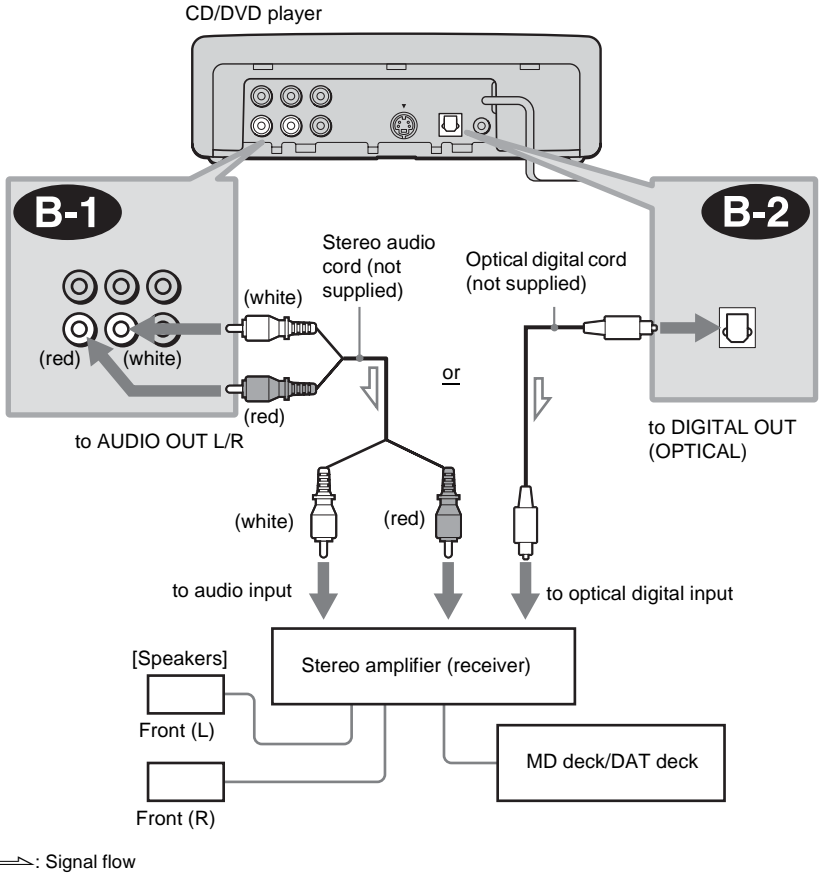

Hint

In connection **B-1**, you can use the supplied audio/video cord instead of using a separate audio cord.

C Connecting to an AV amplifier (receiver) having a Dolby Surround (Pro Logic) decoder and 3 to 6 speakers

You can enjoy the Dolby Surround effects only when playing Dolby Surround audio or multi-channel audio (Dolby Digital) discs.

If your amplifier (receiver) has L and R audio input jacks only, use **C-1**. If your amplifier (receiver) has a digital input jack, use **C-2**.

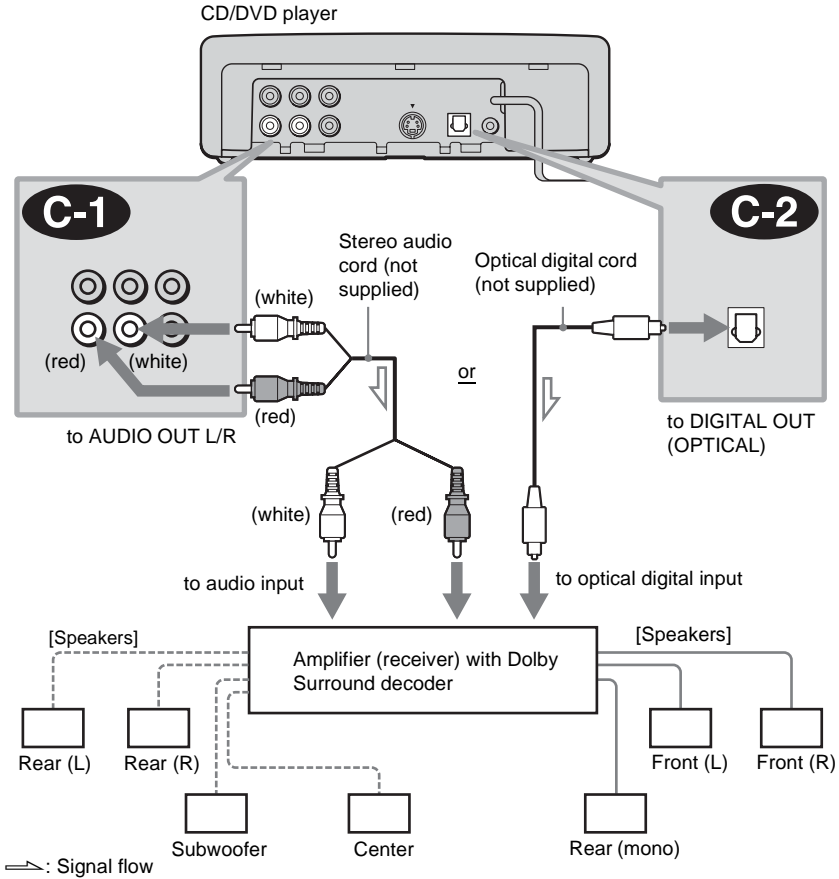

Note

When connecting 6 speakers, replace the monaural rear speaker with a center speaker, 2 rear speakers and a subwoofer.

D Connecting to an AV amplifier (receiver) with a digital input jack having a Dolby Digital or DTS decoder, and 6 speakers

This connection will allow you to use the Dolby Digital or DTS decoder function of your AV amplifier (receiver). You are not able to enjoy the surround sound effects of this player.

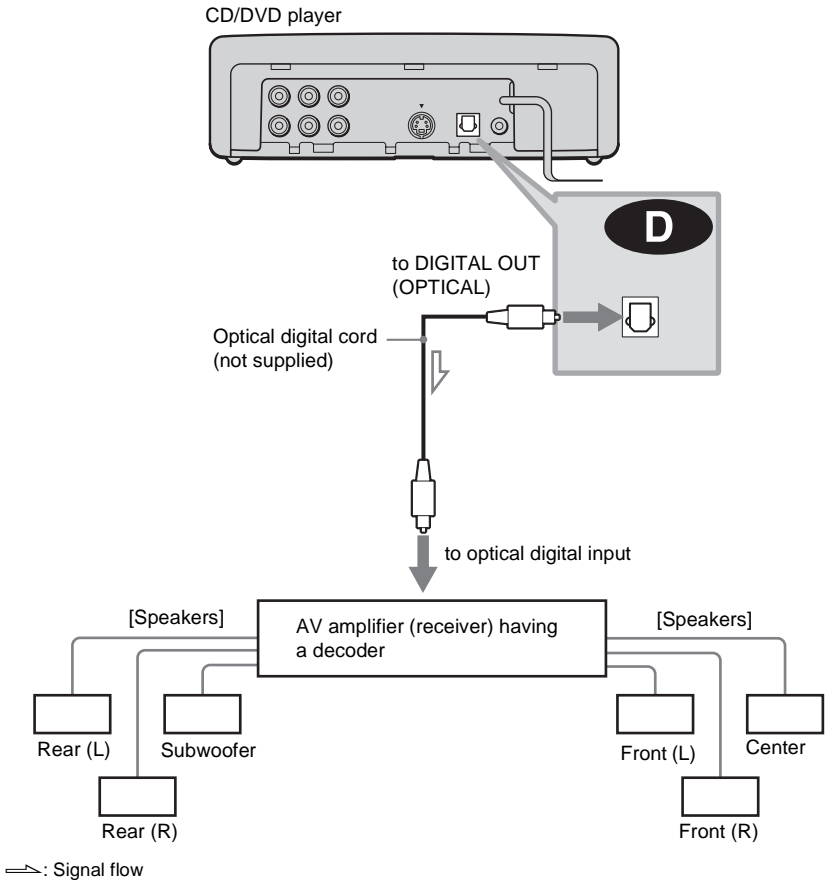

Note

After you have completed the connection, be sure to set "DOLBY DIGITAL" to "DOLBY DIGITAL" and "DTS" to "ON" in Quick Setup (page 25). Otherwise, no sound or a loud noise will come from the speakers.

Step 3: Attaching the Jack Cover and Stand

You can use the player laid flat, or in an upright position by attaching the supplied stand to the rear or side of the player. You can also install the player on the wall.

Attaching the jack cover (Using the player laid flat)

- 1 Gather all the connecting cords together and let them pass through the center of the opening at the back of the player.

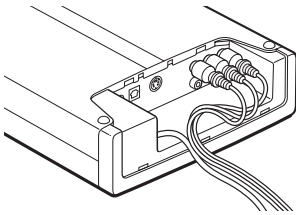

- 2 Attach the jack cover carefully so as not to pinch the cords.

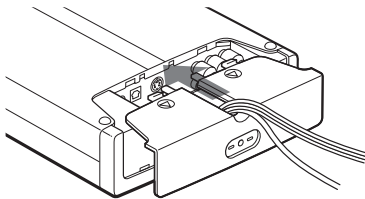

- 3 Place the player flat on a level surface.

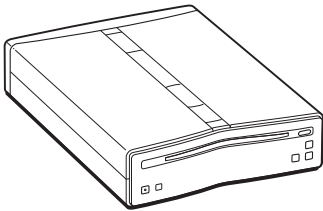

- Do not apply downward force to the player with the disc window facing down. Doing so may cause scratches or damage to the player.
- If you use commercially available cords, it is recommended that you use cords similar in size to the cords provided with the player. If the cords are too thick or stiff, or the plug is too large, you may not be able to attach the jack cover securely. If you cannot attach the jack cover, you do not have to attach the jack cover.

Using the player in the upright position

Make sure you attach the supplied stand.

To stand the player on its rear

- 1 Attach the stand to the screw hole of the jack cover using the supplied screw.

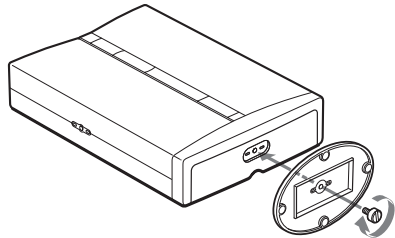

- 2 Place the player upright on the stand.

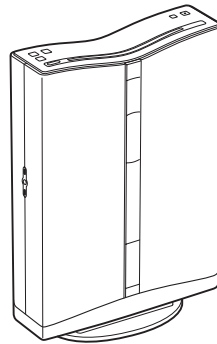

Notes

- Make sure that the connecting cords are not trapped by the jack cover.

To stand the player on its side

- 1 Attach the stand to the screw hole on the side of the player using the supplied screw.

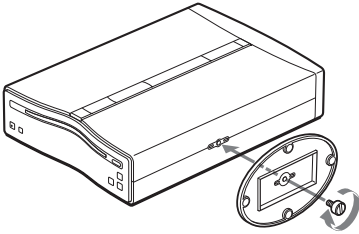

- 2 Place the player on the stand.

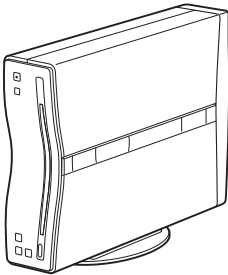

Notes

- Use the supplied stand only when you use the player in an upright position. Do not attach the stand when you use the player laid flat.
- To move the player, hold the player itself. If you hold the stand, it may break.
- Do not use the player in an upright position without attaching the stand. If you do not attach it, the player will be unstable and may fall over.

Installing the player on the wall

Attach the jack cover (page 23). Fastening screws are not supplied. You need to determine the appropriate hanging screws and/or other necessary hardware needed to securely and safely fasten the unit to the wall. Placement of the screws should be at the same height and should be 3-1/4 in. (80 mm) apart. The screws or other fasteners should protrude by 7/32 to 1/4 in. (5 to 6 mm). Please be sure you have selected fasteners or screws that will fit in the hanging holes on the bottom of the unit.

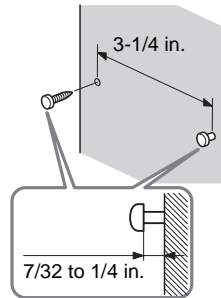

Remove the seals covering the hanging holes. Hang the player on the screws. Push the player tightly against the wall.

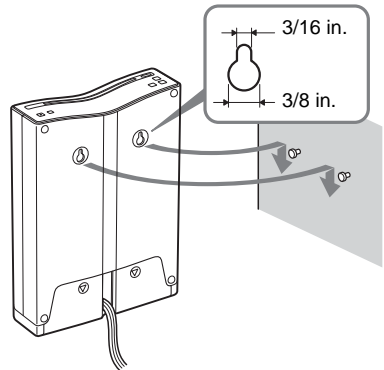

Note

WHEN YOU DISCONNECT OR CONNECT THE CORDS, TAKE THE PLAYER DOWN FROM THE WALL.

Step 4: Connecting the Power Cord

Plug the player and TV power cords into an AC outlet.

Step 5: Quick Setup

Follow the steps below to make the minimum number of basic adjustments for using the player. To skip an adjustment, press **▶▶▶**. To return to the previous adjustment, press **◀◀◀**.

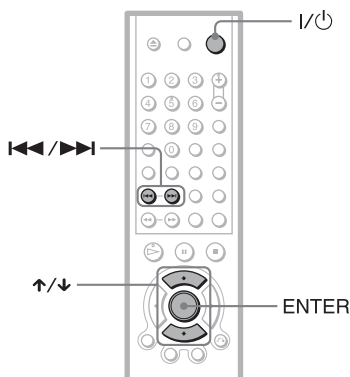

- 1 Turn on the TV.
- 2 Press **I/O**.
- 3 Switch the input selector on your TV so that the signal from the player appears on the TV screen.

“Press [ENTER] to run QUICK SETUP.” appears at the bottom of the screen. If this message does not appear, select “QUICK” under “SETUP” in the Control Bar to run Quick Setup (page 59).

- 4 Press **ENTER** without inserting a disc.

The Setup Display for selecting the language used in the on-screen display appears.

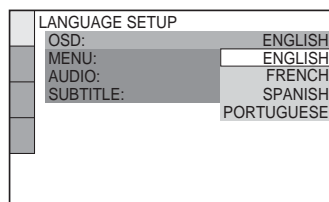

- 5 Press **↑/↓** to select a language.

The player uses the language selected here to display the menu and subtitles as well.

- 6 Press **ENTER**.

The Setup Display for selecting the aspect ratio of the TV to be connected appears.

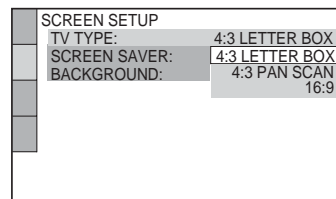

- 7 Press **↑/↓** to select the setting that matches your TV type.

- ◆ If you have a 4:3 standard TV
- 4:3 LETTER BOX or 4:3 PAN SCAN (page 60)

- ◆ If you have a wide-screen TV or a 4:3 standard TV with a wide-screen mode
- 16:9 (page 60)

8 Press ENTER.

The Setup Display for selecting the type of jack used to connect your amplifier (receiver) appears.

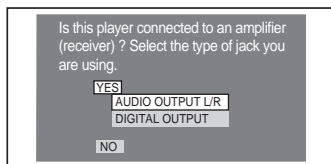

9 Press \uparrow/\downarrow to select the type of jack (if any) you are using to connect to an amplifier (receiver), then press ENTER.

Choose the item that matches the audio connection you selected on pages 19 to 22 (**A** through **D**).

- A**
- If you connect just a TV and nothing else, select “NO.” Quick Setup is finished and connections are complete.

B-1 **C-1**

- Select “AUDIO OUTPUT L/R.” Quick Setup is finished and connections are complete.

B-2 **C-2** **D**

- Select “DIGITAL OUTPUT.” The Setup Display for “DOLBY DIGITAL” appears.

10 Press \uparrow/\downarrow to select the type of Dolby Digital signal you wish to send to your amplifier (receiver).

Choose the signal that matches the audio connection you selected on pages 20 to 22 (**B** through **D**).

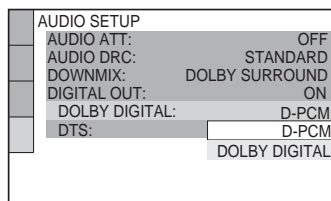

B-2 **C-2**

- D-PCM (page 63)

D

- DOLBY DIGITAL (only if the amplifier (receiver) has a Dolby Digital decoder) (page 63)

11 Press ENTER.

“DTS” is selected.

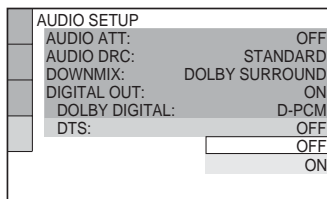

12 Press \uparrow/\downarrow to select whether or not you wish to send a DTS signal to your amplifier (receiver).

Choose the item that matches the audio connection you selected on pages 20 to 22 (**B** through **D**).

B-2 **C-2**

- OFF (page 63)

D

- ON (only if the amplifier (receiver) has a DTS decoder) (page 63)

13 Press ENTER.

Quick Setup is finished. All connections and setup operations are complete.

Enjoying the surround sound effects

To enjoy the surround sound effects of this player or your amplifier (receiver), set the following items as described below for the audio connection you selected on pages 20 to 22 (**B** through **D**). Each of these is the default setting and does not need to be adjusted when you first connect the player. Refer to page 58 for using the Setup Display.

Audio Connection (pages 19 to 22)

A

- No additional settings are needed.

B-1 C-1

- Set "DOWNMIX" to "DOLBY SURROUND" (page 62).
- If the sound distorts even when the volume is turned down, set "AUDIO ATT" to "ON" (page 62).

B-2 C-2 D

- Set "DOWNMIX" to "DOLBY SURROUND" (page 62).
- Set "DIGITAL OUT" to "ON" (page 62).

Playing Discs

Playing Discs **DVD** **VCD** **CD**

DATA CD

Depending on the DVD or VIDEO CD, some operations may be different or restricted. Refer to the operating instructions supplied with your disc.

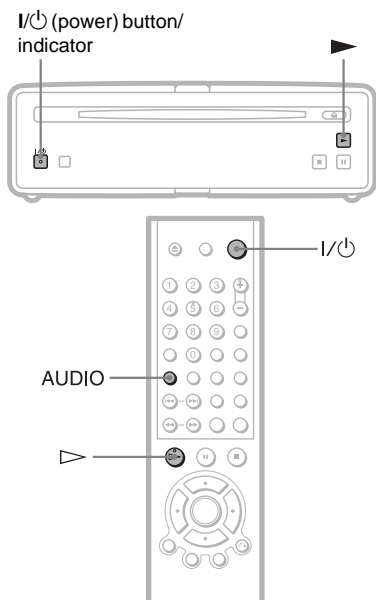

1 Turn on your TV.

2 Press I/⏻.

The player turns on and the power indicator lights up in green.

3 Switch the input selector on your TV so that the signal from the player appears on the TV screen.

◆ **When using an amplifier (receiver)**

Turn on the amplifier (receiver) and select the appropriate channel so that you can hear sound from the player.

4 Insert a disc in the player.

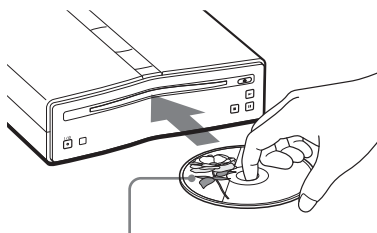

The labeled (or non-playback) side appears through the disc window.

5 Press ▷.

The player starts playback (continuous play). Adjust the volume on the TV or the amplifier (receiver).

Depending on the disc, a menu may appear on the TV screen. For DVDs, see page 32. For VIDEO CDs, see page 33.

To turn off the player

Press I/⏻. The player enters standby mode.

💡 Hint

You can have the player turn off automatically whenever you leave it in stop mode for more than 30 minutes. To turn on this function, set "AUTO POWER OFF" in "CUSTOM SETUP" to "ON" (page 61).

Notes on playing DTS sound tracks on a CD

- When playing DTS-encoded CDs, excessive noise will be heard from the analog stereo jacks. To avoid possible damage to the audio system, the consumer should take proper precautions when the analog stereo jacks of the player are connected to an amplification system. To enjoy DTS Digital Surround™ playback, an external 5.1-channel decoder system must be connected to the digital jack of the player.
- Set the sound to "STEREO" using the AUDIO button when you play DTS sound tracks on a CD (page 45).
- Do not play DTS sound tracks without first connecting the player to an audio component having a built-in DTS decoder. The player outputs the DTS signal via the DIGITAL OUT (OPTICAL) jack even if "DTS" in "AUDIO SETUP" is set to "OFF" in the Setup Display (page 63), and may

affect your ears or cause your speakers to be damaged.

Notes on playing DVDs with a DTS sound track

- DTS audio signals are output only through the DIGITAL OUT (OPTICAL) jack.
- When you play a DVD with DTS sound tracks, set “DTS” to “ON” in “AUDIO SETUP” (page 63).
- If you connect the player to audio equipment without a DTS decoder, do not set “DTS” to “ON” in “AUDIO SETUP” (page 63). A loud noise may come out from the speakers, affecting your ears or causing the speakers to be damaged.

Notes

- When you insert an 8-cm (3-inch) disc, insert the disc slowly at the center of the disc slot. If you cannot eject the disc, consult your nearest Sony dealer.
- No adapter is required in order to play 8-cm (3-inch) discs on this player. If an adapter is used, damage to the player may result; therefore, never use an adapter when playing 8-cm (3-inch) discs.

Additional operations

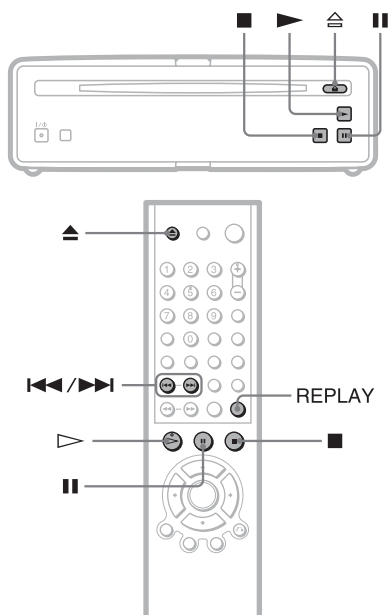

To	Operation
Stop	Press ■
Pause	Press
Resume play after pause	Press or ► or ▷
Go to the next chapter, track, or scene in continuous play mode	Press ►►
Go back to the previous chapter, track, or scene in continuous play mode	Press ◀◀
Stop play and remove the disc	Press ◀ or ▲
Replay the previous scene (DVD only)	Press REPLAY

💡 Hint

The Replay function is useful when you want to review a scene or dialog that you missed.

Note

You may not be able to use the Replay function with some scenes.

Locking the disc slot (Child Lock)

You can lock the disc slot to prevent children from ejecting a disc.

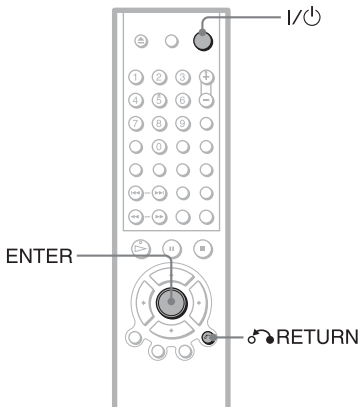

When the player is in standby mode, press **RETURN**, **ENTER**, and then **I/Power** on the remote.

“Locked” appears on the TV screen when you press the **Home/Play** button on the player or the remote.

The **Home/Play** button on the player and the remote do not work while the Child Lock is set.

To unlock the disc slot

When the player is in standby mode, press **RETURN**, **ENTER**, and then **I/Power** again.

Note

Even if you select “RESET” under “SETUP” in the Control Bar (page 58), the disc slot remains locked.

Searching for a Particular Point on a Disc (Scan, Slow-motion Play)

You can quickly locate a particular point on a disc by monitoring the picture or playing back slowly.

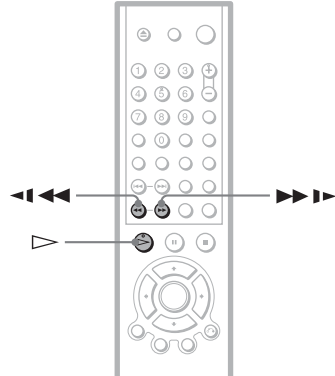

Note

Depending on the DVD/VIDEO CD, you may not be able to do some of the operations described.

Locating a point quickly by playing a disc in fast forward or fast reverse (Scan) **DVD** **VCD** **CD**

DATA CD

Press **Fast Forward** or **Fast Reverse** while playing a disc. When you find the point you want, press **Play** to return to normal speed. Each time you press **Fast Forward** or **Fast Reverse** during scan, the playback speed changes. Three speeds are available. With each press the indication changes as follows:

Playback direction

×2▶ (DVD/CD only) → 1▶▶ → 2▶▶▶

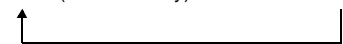

Opposite direction

×2◀ (DVD only) → 1◀◀ → 2◀◀◀



The “×2▶”/“×2◀” playback speed is about twice the normal speed. The “2▶▶”/“2◀◀” playback speed is faster than “1▶▶”/“1◀◀.”

Watching frame by frame (Slow-motion play) **DVD** **VCD**

Press ◀◀◀ or ▶▶▶ when the player is in pause mode. To return to the normal speed, press ▷.

Each time you press ◀◀◀ or ▶▶▶ during Slow-motion play, the playback speed changes. Two speeds are available. With each press the indication changes as follows:

Playback direction

2 ▶▶ ↔ 1 ▶▶

Opposite direction (DVD only)

2 ◀◀ ↔ 1 ◀◀

The “2▶▶”/“2◀◀” playback speed is slower than “1▶▶”/“1◀◀.”

Resuming Playback from the Point Where You Stopped the Disc (Multi-disc Resume) **DVD** **VCD**

The player stores the point where you stopped the disc for up to 6 discs and resumes playback the next time you insert the same disc. When you store a resume playback point for the 7th disc, the resume playback point for the first disc is deleted.

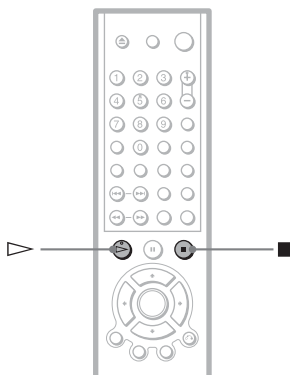

1 While playing a disc, press ■ to stop playback.

“Disc resumes from this point.” appears on the TV screen.

2 Press ▷.

The player starts playback from the point where you stopped the disc in Step 1.

💡 Hints

- To play from the beginning of the disc, press ■ twice, then press ▷.
- For CDs and DATA CDs, the player remembers the resume playback point for the current disc unless the disc is ejected, the power cord plug is disconnected, or only for DATA CDs, the player enters standby mode.

Notes

- “MULTI-DISC RESUME” in “CUSTOM SETUP” must be set to “ON” (default) for this function to work (page 61).
- The resume playback point for the current disc is cleared when:
 - you change the play mode.
 - you change the settings on the Setup Display.
- This function may not work with some discs.
- Resume Play does not work during Shuffle Play and Program Play.

Using the DVD's Menu

DVD

A DVD is divided into long sections of a picture or a music feature called “titles.” When you play a DVD which contains several titles, you can select the title you want using the TOP MENU button. When you play DVDs that allow you to select items such as the language for the subtitles and the language for the sound, select these items using the MENU button.

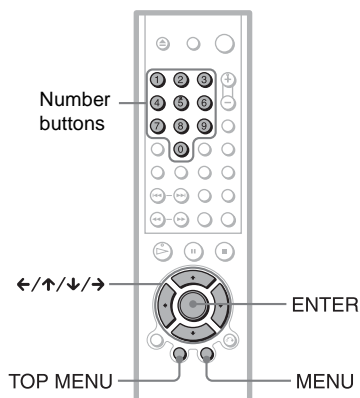

1 Press TOP MENU or MENU.

The disc's menu appears on the TV screen.

The contents of the menu vary from disc to disc.

2 Press $\leftarrow/\uparrow/\downarrow/\rightarrow$ or the number buttons to select the item you want to play or change.

3 Press ENTER.

Playing VIDEO CDs with PBC Functions (PBC Playback)

VCD

PBC (Playback Control) allows you to play VIDEO CDs interactively by following the menu on the TV screen.

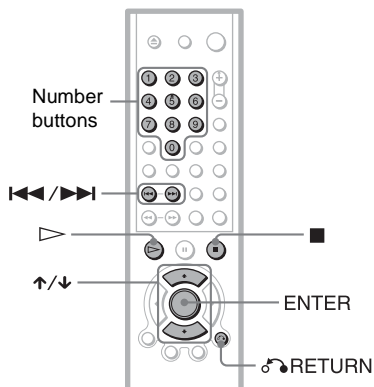

1 Start playing a VIDEO CD with PBC functions.

The menu for your selection appears.

2 Select the item number and track you want using \uparrow/\downarrow or the number buttons.

3 Press ENTER.

4 Follow the instructions in the menu for interactive operations.

Refer to the instructions supplied with the disc, as the operating procedure may differ depending on the VIDEO CD.

Hint

To play without using PBC, press \lll/\ggg while the player is stopped to select a track, then press \triangleright or ENTER.

“Play without PBC.” appears on the TV screen and the player starts continuous play. You cannot play still pictures such as a menu.

To return to PBC playback, press \blacksquare twice then press \triangleright .

Note

Depending on the VIDEO CD, “Press ENTER” in Step 3 may appear as “Press SELECT” in the instructions supplied with the disc. In this case, press \triangleright .

To return to the menu

Press \circlearrowleft RETURN.

Playing an MP3 Audio Track **DATA CD**

You can play back DATA CDs (CD-ROMs/CD-Rs/CD-RWs) recorded in MP3 (MPEG1 Audio Layer 3) format.

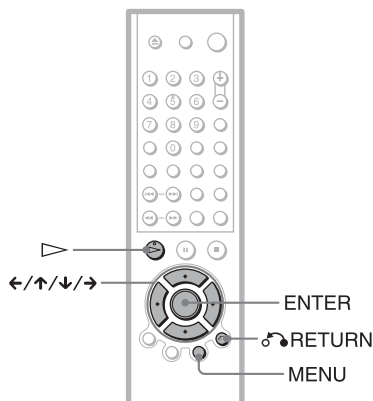

1 Insert a DATA CD in the player.

2 Press .

The player starts to play the first MP3 audio track in the first album on the disc.

Notes



- The playback order may be different from the edited order. See “The playback order of MP3 audio tracks” (page 35) for details.
- This player can play MP3 audio tracks recorded in the following sampling frequencies: 32 kHz, 44.1 kHz, 48 kHz.

Selecting an album and track

1 Press MENU.

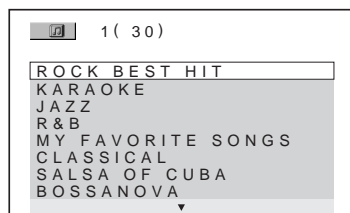

The list of MP3 albums recorded on the DATA CD appears.



2 Select an album using / and press ENTER.

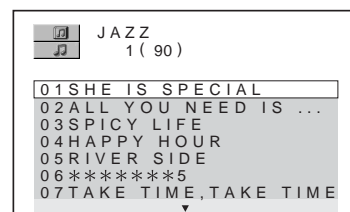

The list of tracks contained in the album appears.



3 Select a track using / and press ENTER.

The selected track starts playing.
When a track or album is being played, its title is shaded.

To go to the next or previous page

Press  or .

To return to the previous display

Press  RETURN.

To turn off the display

Press MENU.

Notes

- Only the letters in the alphabet and numbers can be used for album or track names. Anything else is displayed as an asterisk (*).
- ID3 tags cannot be displayed.

About MP3 audio tracks

You can play MP3 audio tracks on CD-ROMs, CD-Rs, or CD-RWs. However, the discs must be recorded according to ISO9660 level 1, level 2, or Joliet format for the player to recognize the tracks.

You can also play discs recorded in Multi Session.

See the instructions of the CD-R/RW device or recording software (not supplied) for details on the recording format.

To play a Multi Session CD

This player can play Multi Session CDs when an MP3 audio track is located in the first session. Any subsequent MP3 audio tracks, recorded in the later sessions, can also be played back.

When audio tracks and images in music CD format or video CD format are recorded in the first session, only the first session will be played back.

Notes

- If you put the extension “.MP3” to data not in MP3 format, the player cannot recognize the data properly and will generate a loud noise which could damage your speaker system.
- The player cannot play audio tracks in MP3PRO format.

The playback order of MP3 audio tracks

The playback order of albums and tracks recorded on a DATA CD is as follows.

◆ Structure of disc contents

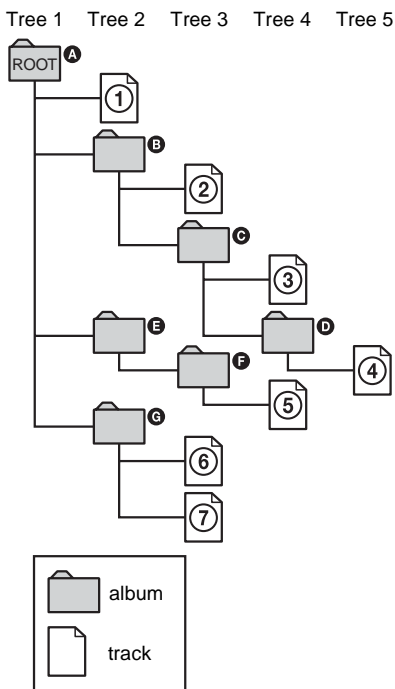

When you insert a DATA CD and press \triangleright , the numbered tracks are played sequentially, from ① through ⑦. Any sub-albums/tracks contained within a currently selected album take priority over the next album in the same tree. (Example: C contains D so ④ is played before ⑤.)

When you press MENU and the list of MP3 albums appears (page 34), the albums are arranged in the following order: A → B → C → D → F → G. Albums that do not contain tracks (such as album E) do not appear in the list.

💡 Hints

- If you add numbers (01, 02, 03, etc.) to the front of the track names, the tracks will be played in that order.
- Since a disc with many trees takes longer to start playback, place your albums within the first two trees.

Notes

- Depending on the software you use to create the DATA CD, the playback order may differ from the illustration above.
- The playback order above may not be applicable if there are more than a total of 200 albums and tracks in the DATA CD.
- The player can recognize up to 100 albums (the player will count just albums, including albums that do not contain MP3 audio tracks). The player will not play any albums beyond the first 100 albums. Of the first 100 albums, the player will play no more than a combined total of 200 albums and tracks.

Various Play Mode Functions (Program Play, Shuffle Play, Repeat Play, A-B Repeat Play)

You can set the following play modes:

- Program Play (page 36)
- Shuffle Play (page 38)
- Repeat Play (page 39)
- A-B Repeat Play (page 40)

Note

The play mode is canceled when:

- the player enters standby mode by pressing **I/⏻**.
- you eject the disc.

Creating your own program (Program Play) **DVD** **VCD** **CD**

You can play the contents of a disc in the order you want by arranging the order of the titles, chapters, or tracks on the disc to create your own program.

You can program up to 99 items.

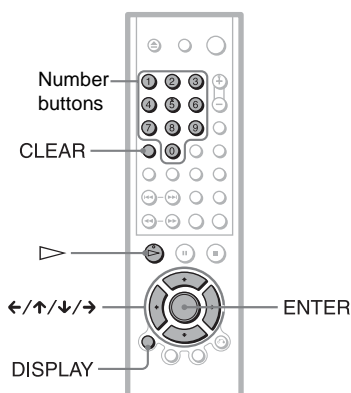

- 1** Press **DISPLAY** twice while the player is in stop mode.

The following Control Bar appears.

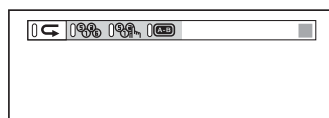

2 Press **←/→** to select **PROGRAM**, then press **ENTER**.

“TRACK” is displayed when you play a VIDEO CD or CD.

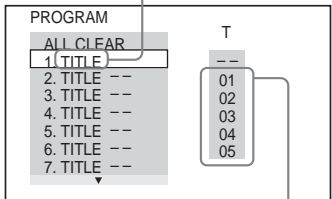

Titles or tracks recorded on a disc

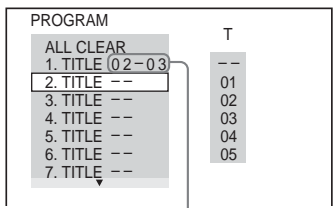

Selected title and chapter

◆ When playing a VIDEO CD or CD
For example, select track “02.”
Press **↑/↓** or the number buttons to select “02” under “T,” then press **ENTER**.

3 Press **→**.
The cursor moves to the title or track row “T” (in this case, “01”).

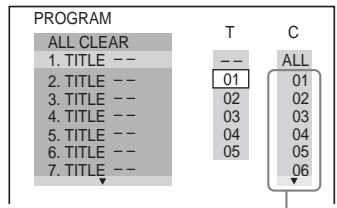

Chapters recorded on a disc

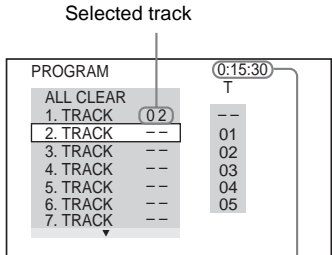

Total time of the programmed tracks

4 Select the title, chapter, or track you want to program.

◆ When playing a DVD
For example, select chapter “03” of title “02.”
Press **↑/↓** or the number buttons to select “02” under “T,” then press **ENTER**.

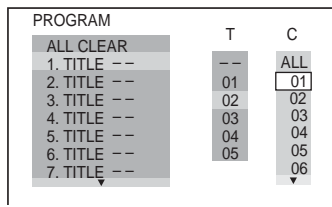

Next, press **↑/↓** or the number buttons to select “03” under “C,” then press **ENTER**.

5 To program other titles, chapters, or tracks, repeat Steps 3 to 4.
The programmed titles, chapters, and tracks are displayed in the selected order.

6 Press **▷** to start Program Play.
Program Play begins.
When the program ends, you can restart the same program again by pressing **▷**.

To stop Program Play
Press **CLEAR**.

To turn off the display
Press **DISPLAY** repeatedly until the display is turned off.

To cancel or change a program

- 1 Follow Steps 1 and 2 of “Creating your own program (Program Play).”
- 2 Select the program number of the title, chapter, or track you want to cancel or change using **↑/↓** or the number buttons, and press **→**.

- 3 Follow Step 5 for new programming. To cancel a program, select "--" under "T," then press ENTER.

To cancel all the titles, chapters, or tracks in the program

- 1 Follow Steps 1 and 2 of "Creating your own program (Program Play)."
- 2 Press **↑** and select "ALL CLEAR."
- 3 Press ENTER.

Hint

You can do Repeat Play or Shuffle Play of the programmed titles, chapters, or tracks. During Program Play, follow the steps of "Repeat Play" (page 39) or "Shuffle Play" (page 38).

Playing in random order (Shuffle Play) **DVD VCD CD**

You can have the player "shuffle" titles, chapters, or tracks. Subsequent "shuffling" may produce a different playing order.

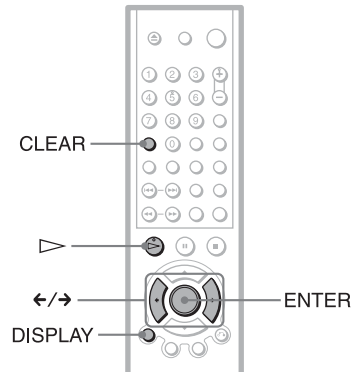

- 1 Press **DISPLAY** during playback. The following Control Bar appears.

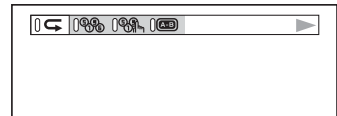

- 2 Press **←/→** to select  (SHUFFLE), then press **ENTER** repeatedly to select the item to be shuffled.

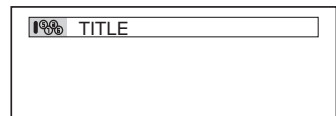

- ◆ When playing a DVD
 - TITLE
 - CHAPTER
 - ◆ When playing a VIDEO CD or CD
 - TRACK
 - ◆ When Program Play is activated
 - ON: shuffles titles, chapters, or tracks selected in Program Play.
-

To return to normal play

Press CLEAR, or select "OFF" in Step 2.

To turn off the Control Bar

Press DISPLAY repeatedly until the Control Bar is turned off.

Hints

- You can set Shuffle Play while the player is stopped. After selecting the "SHUFFLE" option, press . Shuffle Play starts.
- Up to 200 chapters in a disc can be played in random order when "CHAPTER" is selected.

Playing repeatedly (Repeat Play)

DVD VCD CD DATA CD

You can play all of the titles, albums or tracks on a disc or a single title, chapter, album, or track repeatedly.

You can use a combination of Shuffle or Program Play modes.

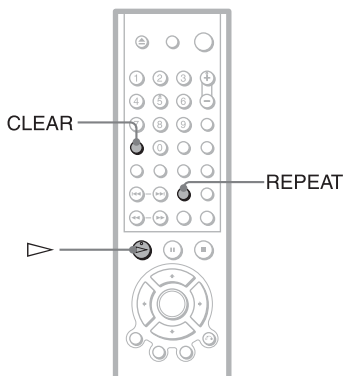

1 Press REPEAT during playback.

The following Control Bar appears.

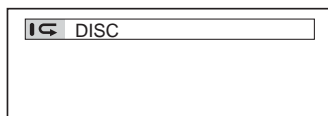

2 Press REPEAT repeatedly to select the item you want to set.

◆ When playing a DVD

- DISC: repeats all of the titles.
- TITLE: repeats the current title on a disc.
- CHAPTER: repeats the current chapter.

◆ When playing a VIDEO CD or CD

- DISC: repeats all of the tracks.
- TRACK: repeats the current track.

◆ When playing a DATA CD (MP3 audio)

- DISC: repeats all of the albums.
- ALBUM: repeats the current album.
- TRACK: repeats the current track.

◆ When Program Play or Shuffle Play is activated

- ON: repeats Program Play or Shuffle Play.

To return to normal play

Press CLEAR, or select "OFF" in Step 2.

Hint

You can set Repeat Play while the player is stopped. After selecting the "REPEAT" option, press . Repeat Play starts.

Repeating a specific portion (A-B Repeat Play)

You can play a specific portion of a title, chapter or track repeatedly. (This function is useful when you want to memorize lyrics, etc.)

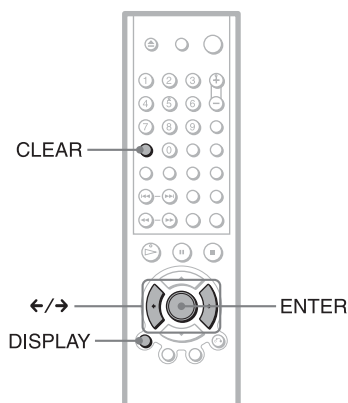

- 1 Press DISPLAY during playback.**
The following Control Bar appears.

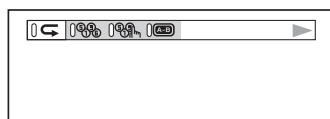

- 2 Press \leftarrow/\rightarrow to select  (A-B REPEAT).**
- 3 During playback, when you find the starting point (point A) of the portion to be played repeatedly, press ENTER.**
The starting point (point A) is set.

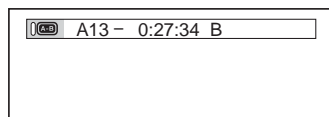

- 4 When you reach the ending point (point B), press ENTER again.**
The set points are displayed and the player starts repeating this specific portion.
-

To return to normal play

Press CLEAR.

To turn off the Control Bar

Press DISPLAY repeatedly until the Control Bar is turned off.

Note

When you set A-B Repeat Play, the settings for Shuffle Play, Repeat Play, and Program Play are canceled.

Searching for a Scene

Searching for a Title/ Chapter/Track/Index/ Scene (Search mode)

DVD VCD CD DATA CD

You can search a DVD by title or chapter, and you can search a VIDEO CD/CD/DATA CD by track, index, or scene. As titles and tracks are assigned unique numbers on the disc, you can select the desired one by entering its number. Or, you can search for a scene using the time code.

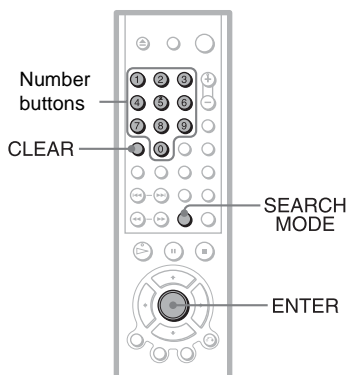

1 Press SEARCH MODE.

The following display appears. “-- (**)” appears next to the icon (** refers to a number).

The number in parentheses indicates the total number of titles, tracks, indexes, scenes, etc. of the disc.

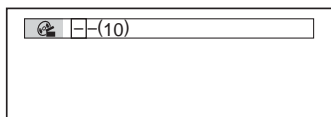

2 Press SEARCH MODE repeatedly to select the search method.

◆ When playing a DVD

- (TITLE)
- (CHAPTER)
- (TIME/TEXT)
- (NUMBER INPUT)

Select “TIME/TEXT” to search for a starting point by inputting the time code.

◆ When playing a VIDEO CD

- (TRACK)
- (INDEX)

◆ When playing a VIDEO CD with PBC Playback

- (SCENE)
- (INDEX)

◆ When playing a CD

- (TRACK)
- (INDEX)

◆ When playing a DATA CD (MP3 audio)

- (ALBUM)
- (TRACK)

3 Select the number of the title, track, scene, time code, etc. you want using the number buttons.

For example, to find the scene at 2 hours, 10 minutes, and 20 seconds after the beginning, select “TIME/TEXT” in Step 2 and enter “2:10:20.”

If you make a mistake

Cancel the number by pressing CLEAR, then select another number.

4 Press ENTER.

The player starts playback from the selected number.

Hint

If you are playing a disc and it is necessary to enter a number, select “NUMBER INPUT” in Step 2.

Viewing Information About the Disc

Checking the Playing Time and Remaining Time

DVD **VCD** **CD** **DATA CD**

You can check the playing time and remaining time of the current title, chapter, or track. Also, you can check the DVD/CD text or track name (MP3 audio) recorded on the disc.

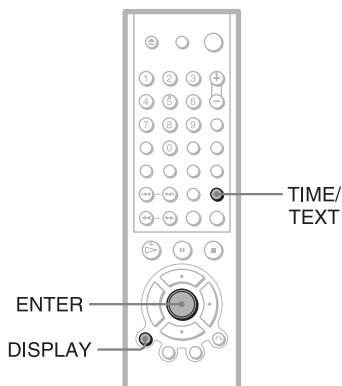

1 Press **DISPLAY** repeatedly during playback until (TIME/TEXT) appears.

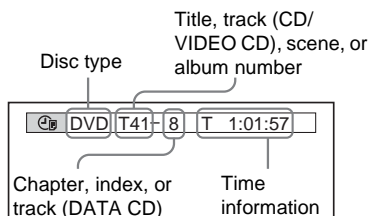

2 Press **ENTER** repeatedly to change the time information.

The display and the kinds of time that you can change depend on the disc you are playing.

◆ When playing a DVD

- T *:*:* (hours:minutes:seconds)
Playing time of the current title
- T-*:*:*
Remaining time of the current title
- C *:*:*
Playing time of the current chapter
- C-*:*:*
Remaining time of the current chapter

◆ When playing a VIDEO CD (with PBC functions)

- *:* (minutes:seconds)
Playing time of the current scene

◆ When playing a VIDEO CD (without PBC functions) or CD

- T *:* (minutes:seconds)
Playing time of the current track
- T-*:*
Remaining time of the current track
- D *:*
Playing time of the current disc
- D-*:*
Remaining time of the current disc

◆ When playing a DATA CD (MP3 audio)

- *:* (minutes:seconds)
Playing time of the current track

To turn off the Control Bar

Press **DISPLAY** repeatedly until the Control Bar is turned off.

To check the DVD/CD text or track name (MP3 audio)

Press **ENTER** repeatedly in Step 2 to display text recorded on the DVD/CD/DATA CD. The DVD/CD text appears only when text is recorded in the disc. You cannot change the text. If the disc does not contain text, "NO TEXT" appears.

For DATA CDs, only the track name of the MP3 audio track appears.

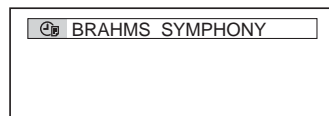

Hints

- When playing VIDEO CDs with PBC functions, the scene number and the playing time are displayed.
- You can also check the time information and text by pressing TIME/TEXT repeatedly.

Notes

- Depending on the type of disc being played, the disc's text or track name may not be displayed.
- The player can only display the first level of the DVD/CD text, such as the disc name or title.
- Playing time of MP3 audio tracks may not be displayed correctly.

Sound Adjustments

Changing the Sound

DVD VCD CD DATA CD

When playing a DVD recorded in multiple audio formats (PCM, Dolby Digital, or DTS), you can change the audio format. If the DVD is recorded with multilingual tracks, you can also change the language.

With CDs, DATA CDs, or VIDEO CDs, you can select the sound from the right or left channel and listen to the sound of the selected channel through both the right and left speakers. For example, when playing a disc containing a song with the vocals on the right channel and the instruments on the left channel, you can hear the instruments from both speakers by selecting the left channel.

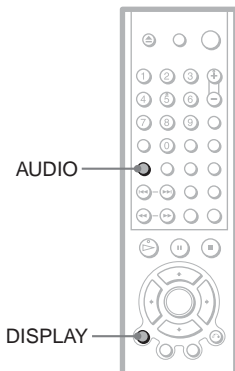

1 Press AUDIO during playback.

The following display appears. The number in parentheses indicates the total number of available audio signals.

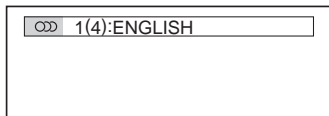

2 Press AUDIO repeatedly to select the desired audio signal.

◆ When playing a DVD

Depending on the DVD, the choice of language varies.

When 4 digits are displayed, they indicate a language code. Refer to “Language Code List” on page 69 to see which language the code represents. When the same language is displayed two or more times, the DVD is recorded in multiple audio formats.

◆ When playing a VIDEO CD, CD, or DATA CD (MP3 audio)

The default setting is underlined.

- STEREO: The standard stereo sound
- 1/L: The sound of the left channel (monaural)
- 2/R: The sound of the right channel (monaural)

Checking the audio signal format **DVD**

If you press DISPLAY repeatedly during playback, the format of the current audio signal (Dolby Digital, DTS, PCM, etc.) appears as shown below.

Example:

Dolby Digital 5.1 ch

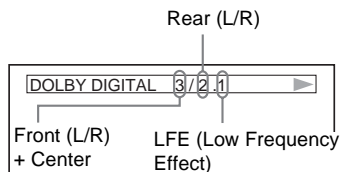

About audio signals

Audio signals recorded in a disc contain the sound elements (channels) shown below. Each channel is output from a separate speaker.

- Front (L)
- Front (R)
- Center
- Rear (L)
- Rear (R)
- Rear (Monaural): This signal can be either the Dolby Surround Sound processed signals or the Dolby Digital sound's monaural rear audio signals.

→ continued

- LFE (Low Frequency Effect) signal

Note

If “DTS” is set to “OFF” in “AUDIO SETUP,” the DTS track selection option will not appear on the screen even if the disc contains DTS tracks (page 63).

TV Virtual Surround Settings (TVS) **DVD**

When you connect a stereo TV or 2 front speakers, TVS (TV Virtual Surround) lets you enjoy surround sound effects by using sound imaging to create virtual rear speakers from the sound of the front speakers (L: left, R: right) without using actual rear speakers. TVS was developed by Sony to produce surround sound for home use using just a stereo TV.

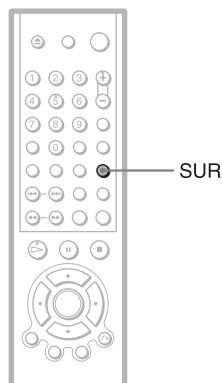

1 Press SUR during playback.

The following Control Bar appears.

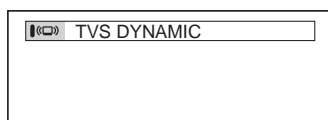

2 Press SUR repeatedly to select one of the TVS sounds.

Refer to the following explanations given for each item.

- TVS DYNAMIC
- TVS WIDE
- TVS NIGHT
- TVS STANDARD

To cancel the setting

Select “OFF” in Step 2.

◆TVS DYNAMIC

Creates virtual rear speakers from the sound of the front speakers (L, R) without using actual rear speakers (shown below).

This mode is effective when the distance between the front L and R speakers is short, such as with built-in speakers on a stereo TV.

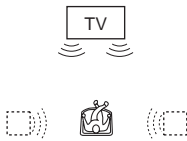

◆TVS WIDE

Creates virtual rear speakers from the sound of the front speakers (L, R) without using actual rear speakers. The virtual speakers are reproduced as shown in the illustration below.

This mode is effective when the distance between the front L and R speakers is short, such as with built-in speakers on a stereo TV.

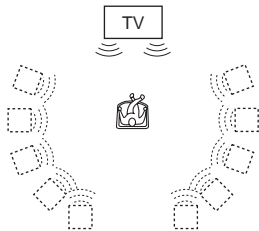

◆TVS NIGHT

Large sounds, such as explosions, are suppressed, but the quieter sounds are unaffected. This feature is useful when you want to hear the dialog and enjoy the surround sound effects of “TVS WIDE” at low volume.

◆TVS STANDARD

Creates virtual rear speakers from the sound of the front speakers (L, R) without using actual rear speakers. The virtual speakers are reproduced as shown in the illustration below. Use this setting when you want to use TVS with 2 separate speakers.

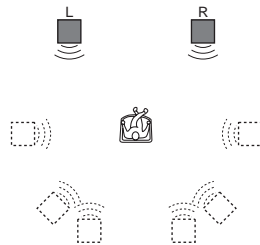

L : Front speaker (left)
R : Front speaker (right)
□ : Virtual speaker

Notes

- When the playing signal does not contain a signal for the rear speakers, the surround effects will be difficult to hear.
- When you select one of the TVS modes, turn off the surround setting of the connected TV or amplifier (receiver).
- Make sure that your listening position is between and at an equal distance from your speakers, and that the speakers are located in similar surroundings.
- “TVS NIGHT” only works with Dolby Digital discs. However, not all discs will respond to the “TVS NIGHT” function in the same way.

Changing the Angles DVD

If various angles (multi-angles) for a scene are recorded on the DVD, the  indicator on the Control Bar lights up in blue. This means that you can change the viewing angle.

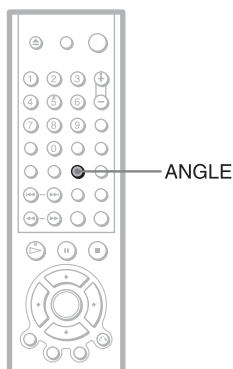

1 Press ANGLE during playback.

The following Control Bar appears. The number in parentheses indicates the total number of available angles.

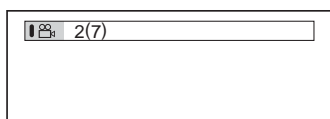

2 Press ANGLE repeatedly to select the angle number.

The scene changes to the selected angle.

Note

Depending on the DVD, you may not be able to change the angles even if multi-angles are recorded on the DVD.

Displaying the Subtitles

DVD

If subtitles are recorded on the discs, you can change the subtitles or turn them on and off whenever you want while playing a DVD.

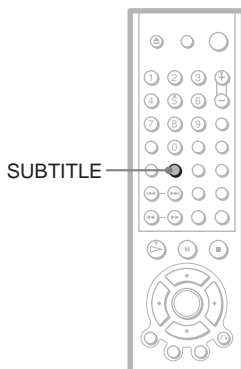

1 Press SUBTITLE during playback.

The following display appears. The number in parentheses indicates the total number of available subtitles.

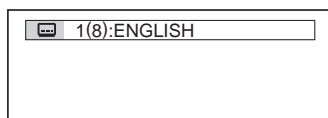

2 Press SUBTITLE repeatedly to select the language.

Depending on the DVD, the choice of language varies.

When 4 digits are displayed, they indicate a language code. Refer to "Language Code List" on page 69 to see which language the code represents.

To turn off the subtitles

Select "OFF" in Step 2.

Note

Depending on the DVD, you may not be able to change the subtitles even if multilingual subtitles are recorded on it. You also may not be able to turn them off.

Adjusting the Picture Quality (BNR) **DVD** **VCD**

The Block Noise Reduction (BNR) function adjusts the picture quality by reducing the “block noise” or mosaic like patterns that appear on your TV screen.

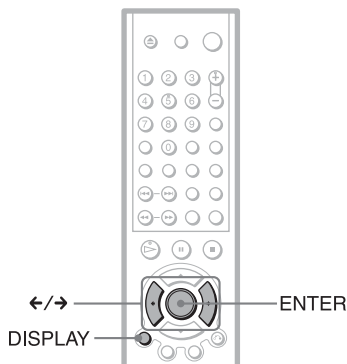

1 Press DISPLAY twice during playback.

The following Control Bar appears.

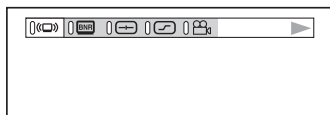

2 Press ←/→ to select **BNR** (BNR), then press ENTER repeatedly to select a level.

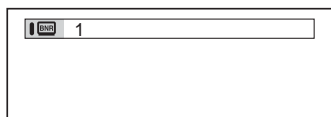

- 1: reduces the “block noise.”
- 2: reduces the “block noise” more than 1.
- 3: reduces the “block noise” more than 2.

To cancel the “BNR” setting

Select “OFF” in Step 2.

To turn off the Control Bar

Press DISPLAY repeatedly until the Control Bar is turned off.

Notes

- If the outlines of the images on your screen should become blurred, set “BNR” to “OFF.”
- Depending on the disc or the scene being played, the “BNR” effect may be hard to discern.

Adjusting the Playback Picture (CUSTOM PICTURE MODE)

DVD VCD

You can adjust the video signal of the DVD or VIDEO CD from the player to obtain the picture quality you want. Choose the setting that best suits the program you are watching.

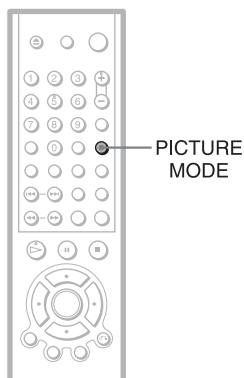

richer, and the color contrast is increased.

💡 Hint

When you watch a movie, "CINEMA 1" or "CINEMA 2" is recommended.

1 Press PICTURE MODE during playback.

The following Control Bar appears.

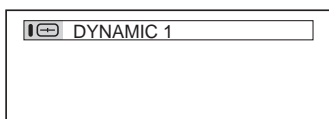

2 Press PICTURE MODE repeatedly to select the setting you want.

The default setting is underlined.

- STANDARD: displays a standard picture.
- DYNAMIC 1: produces a bold dynamic picture by increasing the picture contrast and the color intensity.
- DYNAMIC 2: produces a more dynamic picture than DYNAMIC 1 by further increasing the picture contrast and the color intensity.
- CINEMA 1: enhances details in dark areas by increasing the black level.
- CINEMA 2: White colors become brighter and black colors become

Enhancing the Playback Picture (DIGITAL VIDEO ENHANCER)

DVD VCD

The Digital Video Enhancer (DVE) function makes the picture appear clear and crisp by enhancing the outlines of images on your TV screen. Also, this function can soften the images on the screen.

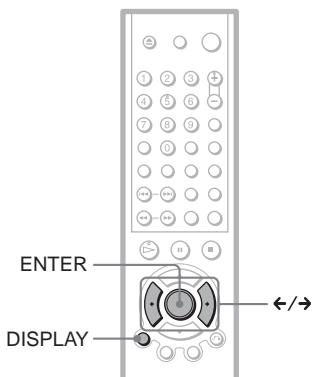

1 Press DISPLAY twice during playback.

The following Control Bar appears.

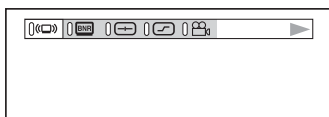

2 Press \leftarrow/\rightarrow to select  (DIGITAL VIDEO ENHANCER), then press ENTER repeatedly to select a level.

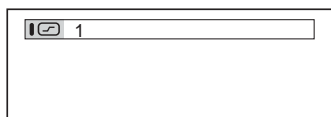

- 1: enhances the outline.
- 2: enhances the outline more than 1.
- 3: enhances the outline more than 2.
- SOFT: softens the image (DVD only).

To cancel the "DIGITAL VIDEO ENHANCER" setting

Select "OFF" in Step 2.

To turn off the Control Bar

Press DISPLAY repeatedly until the Control Bar is turned off.

Note

Depending on the disc or the scene being played, noise found in the disc may become more apparent. If this happens, it is recommended that you use the BNR function (page 49) with the DVE function. If the condition still does not improve, reduce the Digital Video Enhancer level, or select "SOFT" (DVD only) in Step 2 above.

Using Various Additional Functions

Locking Discs (CUSTOM PARENTAL CONTROL, PARENTAL CONTROL)

You can set two kinds of playback restrictions for the desired disc.

- Custom Parental Control
You can set playback restrictions so that the player will not play inappropriate discs.
- Parental Control
Playback of some DVDs can be limited according to a predetermined level such as the age of the users. Scenes may be blocked or replaced with different scenes. The same password is used for both Parental Control and Custom Parental Control.

Custom Parental Control

DVD VCD CD

You can set the same Custom Parental Control password for up to 40 discs. When you set the 41st-disc, the first disc is canceled.

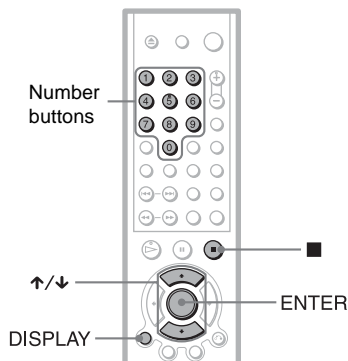

- 1 Insert the disc you want to lock.
If the disc is playing, press ■ to stop playback.
- 2 Press DISPLAY while the player is in stop mode.
The following Control Bar appears.

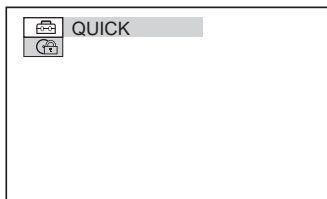

- 3 Press \uparrow/\downarrow to select ■ (PARENTAL CONTROL), then press ENTER.
The options for "PARENTAL CONTROL" appear.

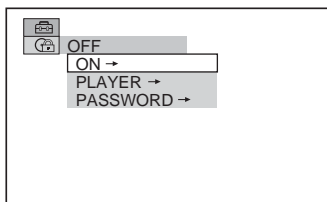

- 4 Press \uparrow/\downarrow to select "ON →," then press ENTER.

◆ If you have not entered a password
The display for registering a new password appears.

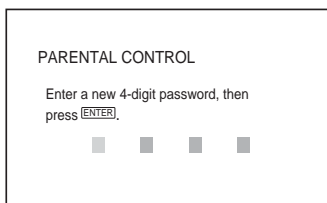

Enter a 4-digit password using the number buttons, then press ENTER.
The display for confirming the password appears.

◆ When you have already registered a password
The display for entering the password appears.

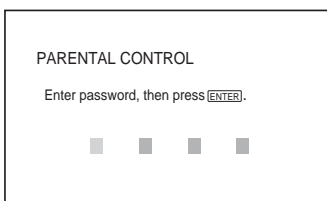

- 5 Enter or re-enter your 4-digit password using the number buttons, then press ENTER.

“Custom parental control is set.” appears when you enter your password.

To turn off the Custom Parental Control function

- 1 Follow Steps 1 through 3 of “Custom Parental Control.”
- 2 Press \uparrow/\downarrow to select “OFF \rightarrow ,” then press ENTER.
- 3 Enter your 4-digit password using the number buttons, then press ENTER.

To play a disc for which Custom Parental Control is set

- 1 Insert the disc for which Custom Parental Control is set. The “CUSTOM PARENTAL CONTROL” display appears.

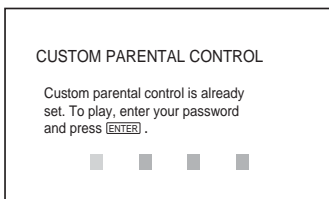

- 2 Enter your 4-digit password using the number buttons, then press ENTER. The player is ready for playback.

Hint

If you forget your password, enter the 6-digit number “199703” using the number buttons when the “CUSTOM PARENTAL CONTROL” display asks you for your password, then press ENTER. The display will ask you to enter a new 4-digit password.

Parental Control (limited playback)

Playback of some DVDs can be limited according to a predetermined level such as the age of the users. The “PARENTAL CONTROL” function allows you to set a playback limitation level.

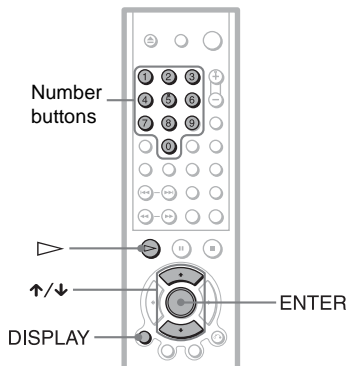

- 1 Press DISPLAY while the player is in stop mode. The following Control Bar appears.

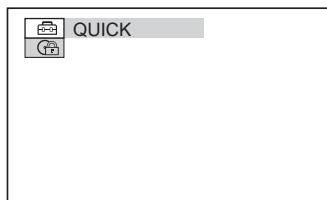

- 2 Press \uparrow/\downarrow to select (PARENTAL CONTROL), then press ENTER. The options for “PARENTAL CONTROL” appear.

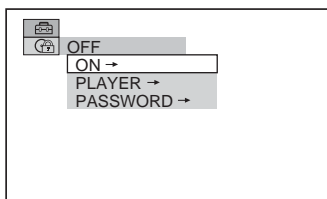

3 Press \uparrow/\downarrow to select "PLAYER \rightarrow ," then press ENTER.

◆ If you have not entered a password

The display for registering a new password appears.

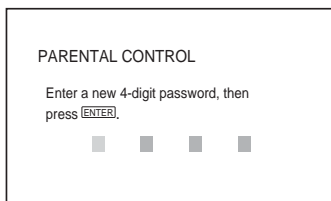

Enter a 4-digit password using the number buttons, then press ENTER. The display for confirming the password appears.

◆ When you have already registered a password

The display for entering the password appears.

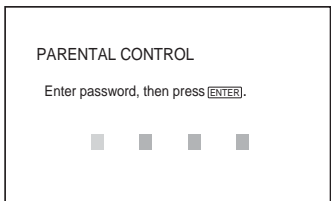

4 Enter or re-enter your 4-digit password using the number buttons, then press ENTER.

The display for setting the playback limitation level appears.

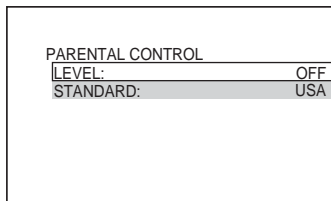

5 Press \uparrow/\downarrow to select "STANDARD," then press ENTER.

The selection items for "STANDARD" are displayed.

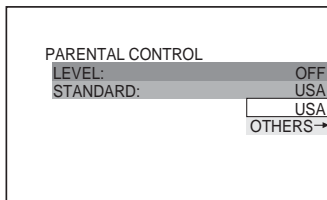

6 Press \uparrow/\downarrow to select a geographic area as the playback limitation level, then press ENTER.

The area is selected.

When you select "OTHERS \rightarrow ," select and enter a standard code in the table on page 55.

7 Press \uparrow/\downarrow to select "LEVEL," then press ENTER.

The selection items for "LEVEL" are displayed.

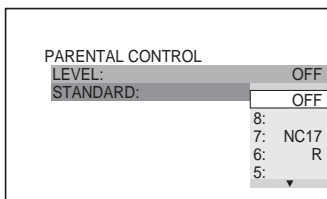

8 Select the level you want using \uparrow/\downarrow , then press ENTER.

Parental Control setting is complete.

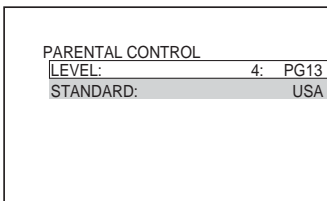

The lower the value, the stricter the limitation.

To turn off the Parental Control function

Set "LEVEL" to "OFF" in Step 8.

To play a disc for which Parental Control is set

- 1 Insert the disc and press \triangleright .
The display for entering your password appears.
- 2 Enter your 4-digit password using the number buttons, then press ENTER.
The player starts playback.

Hint

If you forget your password, remove the disc and repeat Steps 1 to 3 of "Parental Control (limited playback)." When you are asked to enter your password, enter "199703" using the number buttons, then press ENTER. The display will ask you to enter a new 4-digit password. After you enter a new 4-digit password in Step 4, replace the disc in the player and press \triangleright . When the display for entering your password appears, enter your new password.

Note

When you play DVDs which do not have the Parental Control function, playback cannot be limited on this player.

Area Code

Standard	Code number	Standard	Code number
Argentina	2044	Korea	2304
Australia	2047	Malaysia	2363
Austria	2046	Mexico	2362
Belgium	2057	Netherlands	2376
Brazil	2070	New Zealand	2390
Canada	2079	Norway	2379
Chile	2090	Pakistan	2427
China	2092	Philippines	2424
Denmark	2115	Portugal	2436
Finland	2165	Russia	2489
France	2174	Singapore	2501
Germany	2109	Spain	2149
India	2248	Sweden	2499
Indonesia	2238	Switzerland	2086
Italy	2254	Thailand	2528
Japan	2276	United Kingdom	2184

Changing the password

- 1 Press DISPLAY while the player is in stop mode.
The Control Bar appears.
- 2 Press \uparrow/\downarrow to select  (PARENTAL CONTROL), then press ENTER.
The options for "PARENTAL CONTROL" appear.
- 3 Press \uparrow/\downarrow to select "PASSWORD \rightarrow ," then press ENTER.
The display for entering the password appears.
- 4 Enter your 4-digit password using the number buttons, then press ENTER.
- 5 Enter a new 4-digit password using the number buttons, then press ENTER.
- 6 To confirm your password, re-enter it using the number buttons, then press ENTER.

If you make a mistake entering your password

Press **←** before you press ENTER and input the correct number.

If you make a mistake

Press **↶** RETURN.

To turn off the display

Press DISPLAY repeatedly until the display is turned off.

Controlling Your TV with the Supplied Remote

You can control the sound level, input source, and power switch of your TV with the supplied remote. Set the appropriate manufacturer's code.

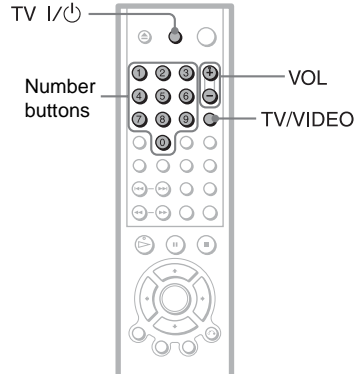

- 1** While holding down TV I/⏻, press the number buttons to select your TV's manufacturer's code (see the table below).
- 2** Release TV I/⏻.

Code numbers of controllable TVs

Manufacturer	Code number
Sony (default)	01
JVC	09
Panasonic	19
Philips	21
RCA	10
Samsung	20
Sanyo	11
Sharp	18
Toshiba	07
Zenith	15

You can control your TV using the buttons below.

By pressing	You can
TV I/⏻	Turn the TV on or off
VOL +/-	Adjust the volume of the TV
TV/VIDEO	Switch the TV's input source between the TV and other input sources

Notes

- Depending on the unit being connected, you may not be able to control your TV using some of the buttons.
- If you enter a new code number, the code number previously entered will be erased.
- When you replace the batteries of the remote, the code number you have set may be reset to the default setting. Set the appropriate code number again.

Settings and Adjustments

Using the Setup Display

By using the Setup Display, you can make various adjustments to items such as picture and sound. You can also set a language for the subtitles and the Setup Display, among other things. For details on each Setup Display item, see pages from 59 to 63.

Note

Playback settings stored in the disc take priority over the Setup Display settings and not all the functions described may work.

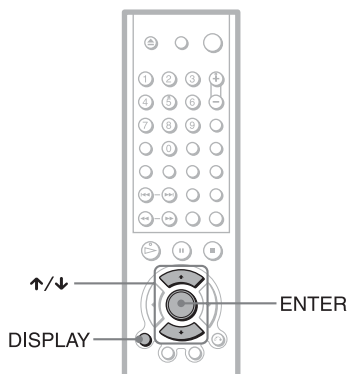

- 1 Press **DISPLAY** when the player is in stop mode.

The Control Bar appears.

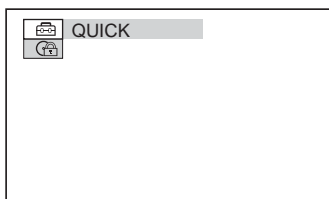

- 2 Press **↑/↓** to select  (SETUP), then press **ENTER**.

- 3 Press **↑/↓** to select "CUSTOM," then press **ENTER**.

The Setup Display appears.

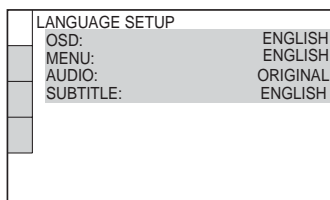

- 4 Press **↑/↓** to select the setup item from the displayed list:

"LANGUAGE SETUP," "SCREEN SETUP," "CUSTOM SETUP," or "AUDIO SETUP." Then press **ENTER**.

The Setup item is selected.

Example: "SCREEN SETUP"

Selected item

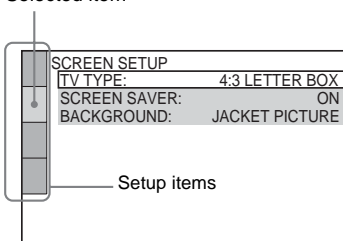

- 5 Select an item using **↑/↓**, then press **ENTER**.

The options for the selected item appear.

Example: "TV TYPE"

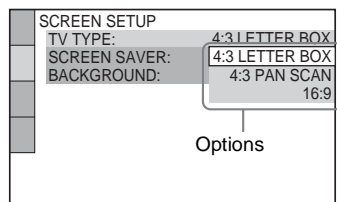

6 Select a setting using \uparrow/\downarrow , then press ENTER.

The setting is selected and setup is complete.

Example: “16:9”

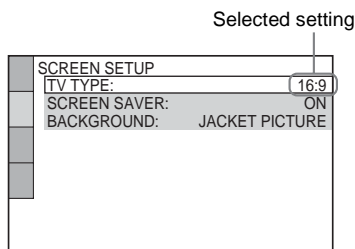

To turn off the display

Press DISPLAY repeatedly until the display is turned off.

To enter the Quick Setup mode

Select “QUICK” in Step 3. Follow from Step 5 of the Quick Setup explanation to make basic adjustments (page 25).

To reset all of the “SETUP” settings

- 1 Select “RESET” in Step 3 and press ENTER.
- 2 Select “YES” using \uparrow/\downarrow .
You can also quit the process and return to the Control Bar by selecting “NO” here.
- 3 Press ENTER.
All the settings explained on pages 59 to 63 return to the default settings. Do not press \mathbb{I}/\mathbb{U} while resetting the player as it takes a few seconds to complete.

Setting the Display or Sound Track Language

(LANGUAGE SETUP)

“LANGUAGE SETUP” allows you to set various languages for the on-screen display or sound track.

Select “LANGUAGE SETUP” in the Setup Display. To use the display, see “Using the Setup Display” (page 58).

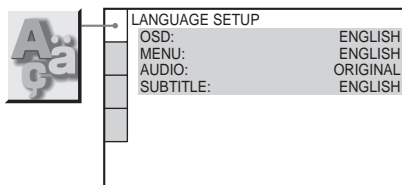

◆ OSD (On-Screen Display)

Switches the display language on the screen.

◆ MENU (DVD only)

You can select the desired language for the disc’s menu.

◆ AUDIO (DVD only)

Switches the language of the sound track. When you select “ORIGINAL,” the language given priority in the disc is selected.

◆ SUBTITLE (DVD only)

Switches the language of the subtitle recorded on the DVD. When you select “AUDIO FOLLOW,” the language for the subtitles changes according to the language you selected for the sound track.

🔔 Hint

If you select “OTHERS \rightarrow ” in “MENU,” “SUBTITLE,” and “AUDIO,” select and enter a language code from “Language Code List” on page 69 using the number buttons.

Note

When you select a language in “MENU,” “SUBTITLE,” or “AUDIO” that is not recorded on the DVD, one of the recorded languages will be automatically selected.

Settings for the Display

(SCREEN SETUP)

Choose settings according to the TV to be connected.

Select "SCREEN SETUP" in the Setup Display. To use the display, see "Using the Setup Display" on page 58.

The default settings are underlined.

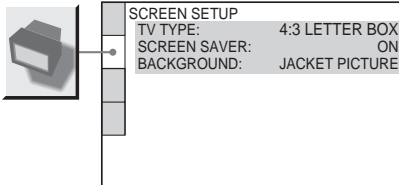

◆ TV TYPE

Selects the aspect ratio of the connected TV (4:3 standard or wide).

<u>4:3 LETTER BOX</u>	Select this when you connect a 4:3 screen TV. Displays a wide picture with bands on the upper and lower portions of the screen.
4:3 PAN SCAN	Select this when you connect a 4:3 screen TV. Automatically displays the wide picture on the entire screen and cuts off the portions that do not fit.
16:9	Select this when you connect a wide-screen TV or a TV with a wide mode function.

4:3 LETTER BOX



4:3 PAN SCAN



16:9



Note

Depending on the DVD, "4:3 LETTER BOX" may be selected automatically instead of "4:3 PAN SCAN" or vice versa.

◆ SCREEN SAVER

The screen saver image appears when you leave the player in pause or stop mode for 15 minutes, or when you play back a CD or DATA CD (MP3 audio) for more than 15 minutes. The screen saver will help prevent your display device from becoming damaged (ghosting). Press \triangleright to turn off the screen saver.

<u>ON</u>	Turns on the screen saver.
OFF	Turns off the screen saver.

◆ BACKGROUND

Selects the background color or picture on the TV screen in stop mode or while playing a CD or DATA CD (MP3 audio).

<u>JACKET PICTURE</u>	The jacket picture (still picture) appears, but only when the jacket picture is already recorded on the disc (CD-EXTRA, etc.). If the disc does not contain a jacket picture, the "GRAPHICS" picture appears.
GRAPHICS	A preset picture stored in the player appears.
BLUE	The background color is blue.
BLACK	The background color is black.

Custom Settings (CUSTOM SETUP)

Use this to set up playback related and other settings.

Select "CUSTOM SETUP" in the Setup Display. To use the display, see "Using the Setup Display" (page 58).

The default settings are underlined.

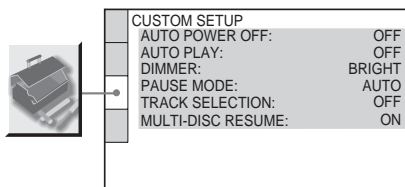

◆ AUTO POWER OFF

Switches the Auto Power Off setting on or off.

<u>OFF</u>	Switches this function off.
ON	The player enters standby mode when left in stop mode for more than 30 minutes.

◆ AUTO PLAY

Switches the Auto Play setting on or off. This function is useful when the player is connected to a timer (not supplied).

<u>OFF</u>	Switches this function off.
ON	Automatically starts playback when the player is turned on.

◆ DIMMER

Adjusts the lighting of the blue illumination on the player.

<u>BRIGHT</u>	Makes the lighting bright.
DARK 1	Makes the lighting dark.
DARK 2	Makes the lighting darker.

◆ PAUSE MODE (DVD only)

Selects the picture in pause mode.

<u>AUTO</u>	The picture, including subjects that move dynamically, is output with no jitter. Normally select this position.
FRAME	The picture, including subjects that do not move dynamically, is output in high resolution.

◆ TRACK SELECTION (DVD only)

Gives the sound track which contains the highest number of channels priority when you play a DVD on which multiple audio formats (PCM, DTS, or Dolby Digital format) are recorded.

<u>OFF</u>	No priority given.
AUTO	Priority given.

Notes

- When you set the item to "AUTO," the language may change. The "TRACK SELECTION" setting has higher priority than the "AUDIO" settings in "LANGUAGE SETUP" (page 59).
- If you set "DTS" to "OFF" (page 63), the DTS sound track is not played even if you set "TRACK SELECTION" to "AUTO."
- If PCM, DTS, and Dolby Digital sound tracks have the same number of channels, the player selects PCM, DTS, and Dolby Digital sound tracks in this order.

◆ MULTI-DISC RESUME (DVD/VIDEO CD only)

Switches the Multi-disc Resume setting on or off. Resume playback can be stored in memory for up to 6 different DVD/VIDEO CD discs (page 31).

<u>ON</u>	Stores the resume settings in memory for up to 6 discs (The settings remain in memory even if you select "OFF.")
OFF	Does not store the resume settings in memory. Playback restarts at the resume point only for the current disc in the player.

Settings for the Sound

(AUDIO SETUP)

“AUDIO SETUP” allows you to set the sound according to the playback and connection conditions.

Select “AUDIO SETUP” in the Setup Display. To use the display, see “Using the Setup Display” (page 58).

The default settings are underlined.

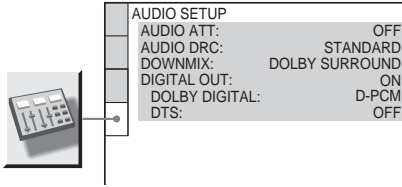

◆ AUDIO ATT (attenuation)

If the playback sound is distorted, set this item to “ON.” The player reduces the audio output level.

This function affects the output of the AUDIO OUT L/R jacks.

<u>OFF</u>	Normally, select this position.
ON	Select this when the playback sound from the speakers is distorted.

◆ AUDIO DRC (Dynamic Range Control) (DVD only)

Makes the sound clear when the volume is turned down when playing a DVD that conforms to “AUDIO DRC.” This affects the output from the following jacks:

- AUDIO OUT L/R jacks
- DIGITAL OUT (OPTICAL) jack only when “DOLBY DIGITAL” is set to “D-PCM” (page 63).

<u>STANDARD</u>	Normally select this position.
TV MODE	Makes the low sounds clear even if you turn the volume down.
WIDE RANGE	Gives you the feeling of being at a live performance.

◆ DOWNMIX (DVD only)

Switches the method for mixing down to 2 channels when you play a DVD which has rear sound elements (channels) or is recorded in Dolby Digital format. For details on the rear signal components, see “Checking the audio signal format” (page 45). This function affects the output of the following jacks:

- AUDIO OUT L/R jacks
- DIGITAL OUT (OPTICAL) jack when “DOLBY DIGITAL” is set to “D-PCM” (page 63).

<u>DOLBY SURROUND</u>	Select this when the player is connected to an audio component that conforms to Dolby Surround (Pro Logic).
NORMAL	Select this when the player is connected to an audio component that does not conform to Dolby Surround (Pro Logic).

◆ DIGITAL OUT

Selects if audio signals are output via the DIGITAL OUT (OPTICAL) jack.

<u>ON</u>	Normally select this position. When you select “ON,” see “Setting the digital output signal” for further settings.
OFF	The influence of the digital circuit upon the analog circuit is minimal.

Setting the digital output signal

Switches the method of outputting audio signals when you connect a component such as an amplifier (receiver) or MD deck with a digital input jack.

For connection details, see page 18.

Select “DOLBY DIGITAL” and “DTS” after setting “DIGITAL OUT” to “ON.”

AUDIO SETUP	
AUDIO ATT:	OFF
AUDIO DRC:	STANDARD
DOWNMIX:	DOLBY SURROUND
DIGITAL OUT:	ON
DOLBY DIGITAL:	D-PCM
DTS:	OFF

If you connect a component that does not conform to the selected audio signal, a loud noise (or no sound) will come out from the speakers, affecting your ears or causing the speakers to be damaged.

◆ DOLBY DIGITAL (DVD only)

Selects the type of Dolby Digital signal.

<u>D-PCM</u>	Select this when the player is connected to an audio component lacking a built-in Dolby Digital decoder. You can select whether the signals conform to Dolby Surround (Pro Logic) or not by making adjustments to the “DOWNMIX” item in “AUDIO SETUP” (page 62).
DOLBY DIGITAL	Select this when the player is connected to an audio component with a built-in Dolby Digital decoder.

◆ DTS (DVD only)

Selects whether or not to output DTS signal.

<u>OFF</u>	Select this when the player is connected to an audio component lacking a built-in DTS decoder.
ON	Select this when the player is connected to an audio component with a built-in DTS decoder.

Additional Information

Troubleshooting

If you experience any of the following difficulties while using the player, use this troubleshooting guide to help remedy the problem before requesting repairs. Should any problem persist, consult your nearest Sony dealer.

Power

The power is not turned on.

- ➔ Check that the AC power cord is connected securely.

Picture

There is no picture/picture noise appears.

- ➔ Re-connect the connecting cord securely.
- ➔ The connecting cord is damaged.
- ➔ Check the connection to your TV (page 16) and switch the input selector on your TV so that the signal from the player appears on the TV screen.
- ➔ The disc is dirty or flawed.
- ➔ If the picture output from your player goes through your VCR to get to your TV or if your player is connected to a combination TV/VIDEO player, the copy-protection signal applied to some DVD programs could affect picture quality. If you still experience problems even when you connect your player directly to your TV, please try connecting your player to your TV's S VIDEO input (page 16).

Even though you set the aspect ratio in "TV TYPE" of "SCREEN SETUP," the picture does not fill the screen.

- ➔ The aspect ratio of the disc is fixed on your DVD.

Sound

There is no sound.

- ➔ Re-connect the connecting cord securely.
- ➔ The connecting cord is damaged.
- ➔ The player is connected to the wrong input jack on the amplifier (receiver) (page 20, 21, 22).

- ➔ The amplifier (receiver) input is not correctly set.
- ➔ The player is in pause mode or in Slow-motion Play mode.
- ➔ The player is in fast forward or fast reverse mode.
- ➔ If the audio signal does not come through the DIGITAL OUT (OPTICAL) jack, check the audio settings (page 63).

Sound is noisy.

- ➔ When playing a CD with DTS sound tracks, noise will come from the AUDIO OUT L/R jacks or DIGITAL OUT (OPTICAL) jack (page 28).

Sound distortion occurs.

- ➔ Set "AUDIO ATT" in "AUDIO SETUP" to "ON" (page 62).

The sound volume is low.

- ➔ The sound volume is low on some DVDs. The sound volume may improve if you set "AUDIO DRC" to "TV MODE" (page 62).
- ➔ Set "AUDIO ATT" in "AUDIO SETUP" to "OFF" (page 62).

Operation

The remote does not function.

- ➔ There are obstacles between the remote and the player.
- ➔ The distance between the remote and the player is too far.
- ➔ The remote is not pointed at the remote sensor on the player.
- ➔ The remote sensor of the player is exposed to strong light.
- ➔ The batteries in the remote are weak.

The disc does not play.

- ➔ There is no disc inside.
- ➔ The disc is turned over. Insert the disc with the labeled (or non-playback) side facing the disc window.
- ➔ The player cannot play certain discs (page 6).
- ➔ The region code on the DVD does not match the player.
- ➔ Moisture has condensed inside the player (page 3).
- ➔ The player cannot play CD-Rs, CD-RWs, DVD-Rs, or DVD-RWs (video mode) that are not finalized (page 6).

“Data error” appears when you play a DATA CD.

- ➔ The MP3 audio track you want to play is broken.
- ➔ The data is not MPEG1 Audio Layer 3 data.

The MP3 audio track cannot be played (page 35).

- ➔ The DATA CD is not recorded in the MP3 format that conforms to ISO9660 Level 1/ Level 2 or Joliet.
- ➔ The MP3 audio track does not have the extension “.MP3.”
- ➔ The data is not formatted in MP3 even though it has the extension “.MP3.”
- ➔ The data is not MPEG1 Audio Layer 3 data.
- ➔ The player cannot play audio tracks in MP3PRO format.

The title of the MP3 audio album or track is not correctly displayed.

- ➔ The player can only display numbers and alphabet. Other characters are displayed as asterisks.

The disc does not start playing from the beginning.

- ➔ Program Play, Shuffle Play, Repeat Play, or A-B Repeat Play has been selected (page 36).
- ➔ Resume play has taken effect (page 31).

The player starts playing the disc automatically.

- ➔ The disc features an auto playback function.
- ➔ “AUTO PLAY” in “CUSTOM SETUP” is set to “ON” (page 61).

Playback stops automatically.

- ➔ While playing discs with an auto pause signal, the player stops playback at the auto pause signal.

You cannot perform some functions such as Stop, Search, Slow-motion Play, Repeat Play, Shuffle Play, or Program Play.

- ➔ Depending on the disc, you may not be able to do some of the operations above. See the operating manual that comes with the disc.

The language for the sound track cannot be changed.

- ➔ Try using the DVD’s menu instead of the direct selection button on the remote (page 32).
- ➔ Multilingual tracks are not recorded on the DVD being played.
- ➔ The DVD prohibits changing of the language for the sound track.

The subtitle language cannot be changed or turned off.

- ➔ Try using the DVD’s menu instead of the direct selection button on the remote (page 32).
- ➔ Multilingual subtitles are not recorded on the DVD being played.
- ➔ The DVD prohibits changing of the subtitles.

The angles cannot be changed.

- ➔ Try using the DVD’s menu instead of the direct selection button on the remote (page 32).
- ➔ Multi-angles are not recorded on the DVD being played.
- ➔ The angle can only be changed when the  indicator lights up in blue on the Control Bar (page 48).
- ➔ The DVD prohibits changing of the angles.

The player does not operate properly.

- ➔ When static electricity, etc., causes the player to operate abnormally, unplug the player.

Five numbers or letters are displayed on the screen.

- ➔ The self-diagnosis function was activated. (See the table on page 66.)

The disc does not eject and “Locked” appears on the TV screen.

- ➔ Child Lock is set (page 30).

The disc does not enter or eject.

- ➔ Moisture has condensed inside the player (page 3).
- ➔ The disc is non-standard shaped (page 3).
- ➔ The disc does not enter if there is an another disc inside.

Self-diagnosis Function

(When letters/numbers appear in the display)

When the self-diagnosis function is activated to prevent the player from malfunctioning, a five-character service number (e.g., C 13 00) with a combination of a letter and four digits appears on the screen. In this case, check the following table.

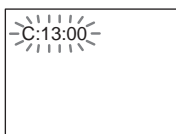

First three characters of the service number	Cause and/or corrective action
C 13	The disc is dirty. ➔ Clean the disc with a soft cloth (page 7).
C 31	The disc is not inserted correctly. ➔ Re-insert the disc correctly.
E XX (xx is a number)	To prevent a malfunction, the player has performed the self-diagnosis function. ➔ Contact your nearest Sony dealer or local authorized Sony service facility and give the 5-character service number. Example: E 61 10

Glossary

Chapter (page 42)

Sections of a picture or a music feature that are smaller than titles. A title is composed of several chapters. Depending on the disc, no chapters may be recorded.

Dolby Digital (page 22, 63)

Digital audio compression technology developed by Dolby Laboratories. This technology conforms to 5.1-channel surround sound. The rear channel is stereo and there is a discrete subwoofer channel in this format. Dolby Digital provides the same 5.1 discrete channels of high quality digital audio found in Dolby Digital cinema audio systems. Good channel separation is realized because all of the channel data are recorded discretely and little deterioration is realized because all channel data processing is digital.

Dolby Surround (Pro Logic) (page 21, 62)

Audio signal processing technology that Dolby Laboratories developed for surround sound. When the input signal contains a surround component, the Pro Logic process outputs the front, center and rear signals. The rear channel is monaural.

DTS (page 22, 63)

Digital audio compression technology that Digital Theater Systems, Inc. developed. This technology conforms to 5.1-channel surround sound. The rear channel is stereo and there is a discrete subwoofer channel in this format. DTS provides the same 5.1 discrete channels of high quality digital audio. Good channel separation is realized because all of the channel data is recorded discretely and little deterioration is realized because all channel data processing is digital.

DVD (page 6)

A disc that contains up to 8 hours of moving pictures even though its diameter is the same as a CD.

The data capacity of a single-layer and single-sided DVD is 4.7 GB (Giga Byte), which is 7 times that of a CD. The data capacity of a double-layer and single-sided DVD is 8.5 GB, a single-layer and double-sided DVD is 9.4 GB, and double-layer and double-sided DVD is 17 GB.

The picture data uses the MPEG 2 format, one of the worldwide standards of digital compression technology. The picture data is compressed to about 1/40 (average) of its original size. The DVD also uses a variable rate coding technology that changes the data to be allocated according to the status of the picture. Audio information is recorded in a multi-channel format, such as Dolby Digital, allowing you to enjoy a more real audio presence.

Furthermore, various advanced functions such as the multi-angle, multilingual, and Parental Control functions are provided with the DVD.

Index (CD)/Video Index (VIDEO CD) (page 42)

A number that divides a track into sections to easily locate the point you want on a CD or VIDEO CD. Depending on the disc, no index may be recorded.

Scene (page 42)

On a VIDEO CD with PBC (playback control) functions, the menu screens, moving pictures and still pictures are divided into sections called “scenes.”

Title (page 42)

The longest section of a picture or music feature on a DVD, movie, etc., in video software, or the entire album in audio software.

Track (page 42)

Sections of a picture or a music feature on a CD or VIDEO CD (the length of a song).

Specifications

System

Laser: Semiconductor laser

Signal format system: NTSC

Audio characteristics

Frequency response: DVD VIDEO (PCM 96 kHz): 2 Hz to 44 kHz (± 1.0 dB)/DVD VIDEO (PCM 48 kHz): 2 Hz to 22 kHz (± 0.5 dB)/CD: 2 Hz to 20 kHz (± 0.5 dB)

Signal-to-noise ratio (S/N ratio): 115 dB (AUDIO OUT L/R jacks only)

Harmonic distortion: 0.003 %

Dynamic range: DVD VIDEO: 103 dB/CD: 99 dB

Wow and flutter: Less than detected value ($\pm 0.001\%$ W PEAK)

When you play PCM sound tracks with a 96 kHz sampling frequency, the output signals from the DIGITAL OUT (OPTICAL) jack are converted to 48 kHz sampling frequency.

Outputs

(Jack name): Jack type/Output level/Load impedance)

AUDIO OUT L/R: Phono jack/2 Vrms/10 kilohms

DIGITAL OUT (OPTICAL): Optical output jack/-18 dBm (wave length: 660 nm)

COMPONENT VIDEO OUT (Y, P_B, P_R):
Phono jack/Y: 1.0 V_{p-p}/P_B, P_R: 0.7 V_{p-p}/75 ohms

VIDEO OUT: Phono jack/1.0 V_{p-p}/75 ohms

S VIDEO OUT: 4-pin mini DIN/
Y: 1.0 V_{p-p}/C: 0.286 V_{p-p}/75 ohms

General

Power requirements:

120 V AC, 60 Hz

Power consumption: 9 W

Dimensions (approx.): 196 × 61 × 265 mm (7 ³/₄ × 2 ¹/₂ × 10 ¹/₂ in.) (width/height/depth) incl. projecting parts

Mass (approx.): 1.8 kg (3 lb 14 oz)

Operating temperature: 5 °C to 35 °C (41 °F to 95 °F)

Operating humidity: 25 % to 80 %

Supplied accessories

See page 13.

Specifications and design are subject to change without notice.

ENERGY STAR® is a U.S. registered mark. As an ENERGY STAR® Partner, Sony Corporation has determined that this product meets the ENERGY STAR® guidelines for energy efficiency.

Language Code List

For details, see pages 45, 48, 59.

The language spellings conform to the ISO 639: 1988 (E/F) standard.

Code Language	Code Language	Code Language	Code Language
1027 Afar	1183 Irish	1347 Maori	1507 Samoan
1028 Abkhazian	1186 Scots Gaelic	1349 Macedonian	1508 Shona
1032 Afrikaans	1194 Galician	1350 Malayalam	1509 Somali
1039 Amharic	1196 Guarani	1352 Mongolian	1511 Albanian
1044 Arabic	1203 Gujarati	1353 Moldavian	1512 Serbian
1045 Assamese	1209 Hausa	1356 Marathi	1513 Siswati
1051 Aymara	1217 Hindi	1357 Malay	1514 Sesotho
1052 Azerbaijani	1226 Croatian	1358 Maltese	1515 Sundanese
1053 Bashkir	1229 Hungarian	1363 Burmese	1516 Swedish
1057 Byelorussian	1233 Armenian	1365 Nauru	1517 Swahili
1059 Bulgarian	1235 Interlingua	1369 Nepali	1521 Tamil
1060 Bihari	1239 Interlingue	1376 Dutch	1525 Telugu
1061 Bislama	1245 Inupiak	1379 Norwegian	1527 Tajik
1066 Bengali;	1248 Indonesian	1393 Occitan	1528 Thai
Bangla	1253 Icelandic	1403 (Afan)Oromo	1529 Tigrinya
1067 Tibetan	1254 Italian	1408 Oriya	1531 Turkmen
1070 Breton	1257 Hebrew	1417 Punjabi	1532 Tagalog
1079 Catalan	1261 Japanese	1428 Polish	1534 Setswana
1093 Corsican	1269 Yiddish	1435 Pashto;	1535 Tonga
1097 Czech	1283 Javanese	Pushto	1538 Turkish
1103 Welsh	1287 Georgian	1436 Portuguese	1539 Tsonga
1105 Danish	1297 Kazakh	1463 Quechua	1540 Tatar
1109 German	1298 Greenlandic	1481 Rhaeto-	1543 Twi
1130 Bhutani	1299 Cambodian	Romance	1557 Ukrainian
1142 Greek	1300 Kannada	1482 Kirundi	1564 Urdu
1144 English	1301 Korean	1483 Romanian	1572 Uzbek
1145 Esperanto	1305 Kashmiri	1489 Russian	1581 Vietnamese
1149 Spanish	1307 Kurdish	1491 Kinyarwanda	1587 Volapük
1150 Estonian	1311 Kirghiz	1495 Sanskrit	1613 Wolof
1151 Basque	1313 Latin	1498 Sindhi	1632 Xhosa
1157 Persian	1326 Lingala	1501 Sangho	1665 Yoruba
1165 Finnish	1327 Laothian	1502 Serbo-	1684 Chinese
1166 Fiji	1332 Lithuanian	Croatian	1697 Zulu
1171 Faroese	1334 Latvian;	1503 Singhalese	
1174 French	Lettish	1505 Slovak	
1181 Frisian	1345 Malagasy	1506 Slovenian	1703 Not specified

Index

Numerics

- 16:9 60
- 4:3 LETTER BOX 60
- 4:3 PAN SCAN 60
- 5.1 Channel Surround 18

A

- A-B REPEAT 40
- ALBUM 42
- Album 34
- ANGLE 48
- AUDIO 45, 59
- AUDIO ATT 62
- AUDIO DRC 62
- AUDIO SETUP 62
- Audio signal format 45
- AUTO PLAY 61
- AUTO POWER OFF 61

B

- BACKGROUND 60
- Batteries 13
- BNR 49

C

- CD 28
- CHAPTER 42
- Chapter 66
- Child Lock 30
- Connecting 16
- Continuous play
 - CD/VIDEO CD 28
 - DATA CD 34
 - DVD 28
- Control Bar 11
- CUSTOM 58
- CUSTOM PARENTAL CONTROL 52
- CUSTOM PICTURE MODE 50
- CUSTOM SETUP 61

D

- DATA CD 6, 34
- DIGITAL OUT 62
- Digital output 63
- DIGITAL VIDEO ENHANCER 51
- DIMMER 61
- Display
 - Control Bar display 11
 - Setup Display 58
- DOLBY DIGITAL 21, 22, 45, 63, 66
- DOWNMIX 62
- DTS 22, 45, 63, 66

- DVD 6, 28, 67
- DVD/CD text 43

F

- Fast forward 30
- Fast reverse 30

H

- Handling discs 7
- Hooking up 16

I

- INDEX 42
- Index 67

J

- Jack cover
 - Attaching 23
 - Removing 9

L

- LANGUAGE SETUP 59
- Locating
 - a specific point by watching the TV screen 30

M

- MENU 59
- Menu
 - DVD's menu 32
 - Top menu 32
- MP3 6, 34, 43
- MULTI-DISC RESUME 31, 61

N

- NUMBER INPUT 42

O

- On-screen display
 - Control Bar display 11
 - Setup Display 58
- OSD 59

P

- PARENTAL CONTROL 53
- PAUSE MODE 61
- PBC Playback 33
- PRO LOGIC 21, 66
- PROGRAM 36
- Program Play 36

Q

- QUICK 59
- Quick Setup 25, 59

R

- Remote 13, 56
- REPEAT 39
- Repeat Play 39
- REPLAY 29
- RESET 59
- Resume Play 31

S

- S VIDEO output 16
- SCENE 42
- Scene 67
- SCREEN SAVER 60
- SCREEN SETUP 60
- Searching 30
- SETUP 58
- Setup Display 58
- SHUFFLE 38
- Shuffle Play 38
- Slow-motion Play 30
- Speakers
 - Hooking up 18
- Stand 23
- SUBTITLE 48, 59
- SURROUND 46

T

- TIME/TEXT 42, 43
- TITLE 42
- Title 67
- TOP MENU 32
- TRACK 42
- Track 34, 67
- TRACK SELECTION 61
- Troubleshooting 64
- TV TYPE 60
- TVS (TV Visual Surround) 46

U

- Usable discs 6

V

- VIDEO CD 6, 28

W

- Wall installation 24



Printed on 100% recycled paper using
VOC (Volatile Organic Compound)-free
vegetable oil based ink.