

Compact Disc Player

Operating Instructions



CDP-CE515
CDP-C460Z

WARNING

To prevent fire or shock hazard, do not expose the unit to rain or moisture.

To avoid electrical shock, do not open the cabinet. Refer servicing to qualified personnel only.

For the customers in the United States

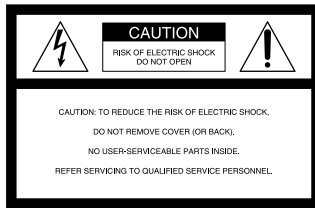

This symbol is intended to alert the user to the presence of uninsulated "dangerous voltage" within the product's enclosure that may be of sufficient magnitude to constitute a risk of electric shock to persons.



This symbol is intended to alert the user to the presence of important operating and maintenance (servicing) instructions in the literature accompanying the appliance.

INFORMATION

This equipment has been tested and found to comply with the limits for a Class B digital device, pursuant to Part 15 of the FCC Rules. These limits are designed to provide reasonable protection against harmful interference in a residential installation. This equipment generates, uses, and can radiate radio frequency energy and, if not installed and used in accordance with the instructions, may cause harmful interference to radio communications. However, there is no guarantee that interference will not occur in a particular installation. If this equipment does cause harmful interference to radio or television reception, which can be determined by turning the equipment off and on, the user is encouraged to try to correct the interference by one or more of the following measures:

- Reorient or relocate the receiving antenna.
- Increase the separation between the equipment and receiver.
- Connect the equipment into an outlet on a circuit different from that to which the receiver is connected.
- Consult the dealer or an experienced radio/TV technician for help.

CAUTION

You are cautioned that any changes or modification not expressly approved in this manual could void your authority to operate this equipment.

Owner's Record

The model and serial numbers are located at the rear of the unit. Record the serial number in the space provided below. Refer to them whenever you call upon your Sony dealer regarding this product.

Model No. _____

Serial No. _____

For the customers in Canada

CAUTION

TO PREVENT ELECTRIC SHOCK, DO NOT USE THIS POLARIZED AC PLUG WITH AN EXTENSION CORD, RECEPTACLE OR OTHER OUTLET UNLESS THE BLADES CAN BE FULLY INSERTED TO PREVENT BLADE EXPOSURE.

For the customers in Europe and Australia

The following caution label is located inside the unit.

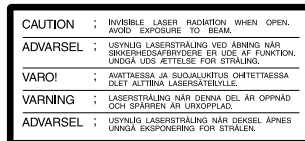

This appliance is classified as a CLASS 1 LASER product.

The CLASS 1 LASER PRODUCT MARKING is located on the rear exterior.

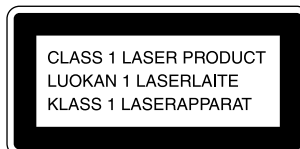

Welcome!

Thank you for purchasing the Sony Compact Disc Player. Before operating the unit, please read this manual thoroughly and retain it for future reference.

About This Manual

The instructions in this manual are for models CDP-CE515 and CDP-C460Z. The CDP-CE515 is the model used for illustration purposes, unless otherwise mentioned. Any difference in operation is clearly indicated in the text, for example, "CDP-CE515 only."

Conventions

- Instructions in this manual describe the controls on the player. You can also use the controls on the remote if they have the same or similar names as those on the player.
- The following icons are used in this manual:



Indicates that you can do the task using the remote.



Indicates hints and tips for making the task easier.

TABLE OF CONTENTS

Getting Started

Unpacking	4
Hooking Up the System	4
Connecting Another CD Player	6

Playing a CD	8
---------------------------	----------

Playing CDs

Using the Display	10
Replacing Discs While Playing a Disc	12
Locating a Specific Disc	12
Locating a Specific Track	13
Locating a Particular Point in a Track	14
Playing Repeatedly	14
Playing in Random Order (Shuffle Play)	14
Creating Your Own Program (Program Play)	15
Controlling Another CD Player (Mega Control)	18
Playing Alternately (No-Delay Play/X-Fade Play)	19

Recording From CDs

Recording Your Own Program	20
Recording a CD by Specifying Tape Length (Time Edit) (CDP-CE515 only)	20
Fading In or Out	21
Adjusting the Recording Level (Peak Search) (CDP-CE515 only)	22

Storing Information About CDs (Custom Files)

What You Can Do With the Custom Files	23
Labeling Discs (Disc Memo)	23
Storing Specific Tracks (Delete Bank)	25

Additional Information

Precautions	26
Notes on CDs	26
Troubleshooting	27
Specifications	27

Index

Index	Back cover
-------------	------------

Unpacking

Check that you received the following items:

- Audio connecting cord (1)
- Remote commander (remote) (1)
- Sony SUM-3 (NS) batteries (2)

Inserting batteries into the remote

You can control the player using the supplied remote. Insert two size AA (R6) batteries by matching the + and - on the batteries. When using the remote, point it at the remote sensor  on the player.

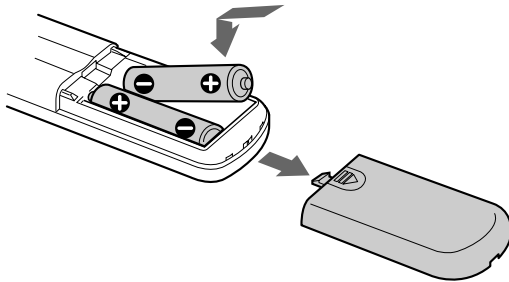

When to replace batteries

With normal use, the batteries should last for about six months. When the remote no longer operates the player, replace all the batteries with new ones.

Notes

- Do not leave the remote near an extremely hot or humid place.
- Do not drop any foreign object into the remote casing, particularly when replacing the batteries.
- Do not expose the remote sensor to direct sunlight or lighting apparatuses. Doing so may cause a malfunction.
- If you don't use the remote for an extended period of time, remove the batteries to avoid possible damage from battery leakage and corrosion.

Hooking Up the System

Overview

This section describes how to hook up the CD player to an amplifier. Be sure to turn off the power of each component before making the connections.

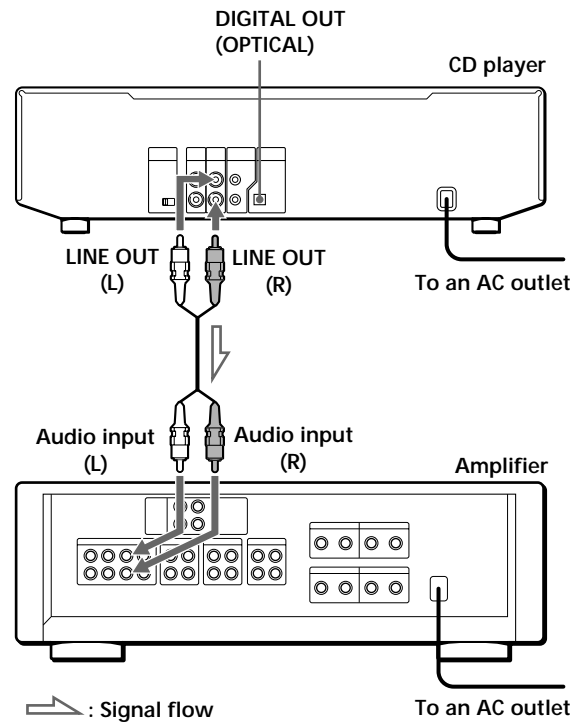

What cords will I need?

Audio cord (supplied) (1)

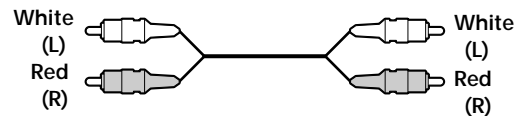

Hookups

When connecting an audio cord, be sure to match the color-coded cord to the appropriate jacks on the components: Red (right) to Red and White (left) to White. Be sure to make connections firmly to avoid hum and noise.

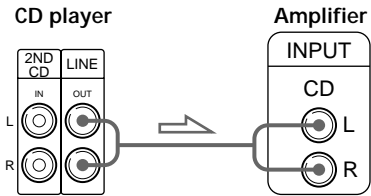

You can adjust the output level to the amplifier

Press LINE OUT LEVEL +/- on the remote. You can reduce the output level up to -20 dB.

When you reduce the output level, " [FADE] " appears in the display.

Note

If you press the LINE OUT LEVEL +/- buttons on the remote while recording, the recording level will change even when it is preset on the tape deck, etc.

• If you have a digital component such as a digital amplifier, D/A converter, DAT or MD

Connect the component via the DIGITAL OUT (OPTICAL) connector using the optical cable (not supplied). Take off the cap and plug in the optical cable.

Note that you cannot use fading in or out (page 21) and Time Fade (page 22) functions when making this connection.

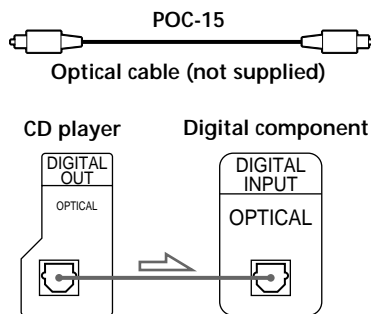

Note

When you connect via the DIGITAL OUT (OPTICAL) connector, noise may occur when you play CD software other than music, such as a CD-ROM.

If you have a Sony component with the CONTROL A1 jack

Connect the component via the CONTROL A1 jack. You can simplify the operation of audio systems composed of separate Sony components. For details, refer to the supplementary "CONTROL-A1 Control System" instructions.

When using another Sony CD player together with this player

You can make the supplied remote effective only for this player.

- When using a player equipped with the COMMAND MODE selector:
 - Leave the COMMAND MODE selector of this player to CD 1 which is set at the factory and set that of another player to CD 2 or CD 3. Then set the CD 1/2/3 switch on the remote supplied for each player accordingly.
- When using a player not equipped with the COMMAND MODE selector:
 - The command mode of the player without the COMMAND MODE selector is set to CD 1. Set the COMMAND MODE selector of this player and the CD 1/2/3 switch on the remote to CD 2 or CD 3.

Connecting the AC power cord

Connect the AC power cord to a wall outlet.

Transporting the player

Before transporting the player, follow the procedure below to return the internal mechanisms back to their original position.

- 1 Remove all the discs from the disc tray.
- 2 Press  OPEN/CLOSE to close the disc tray. "–NO DISC–" appears in the display.
- 3 Wait for 10 seconds, then press POWER to turn off the player.

Connecting Another CD Player

If you have a Sony CD player equipped with the CONTROL A1 jack and the command mode of that player can be set to CD 3, you can control that player as the second player with this unit. After connecting this unit and an amplifier, follow the procedure below. Be sure to turn off the power of each player before making this connection.

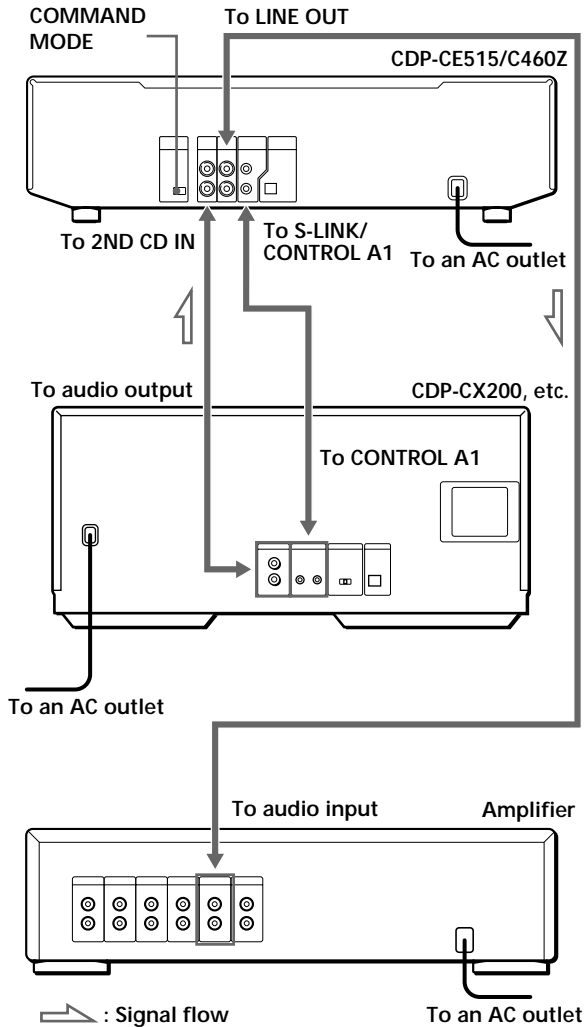

What cords will I need?

- Audio cord (1) (Use the cord supplied with the player to be connected.)
- CONTROL A1 cord (1) (not supplied)

- 1 Connect the players with an audio cord (see also "Hookups" on page 5).

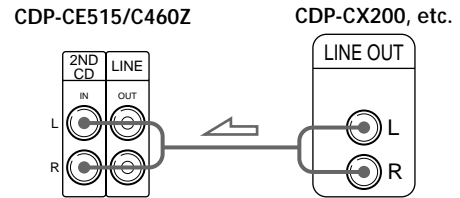

- 2 Connect the players with a CONTROL A1 cord.



For details on this connection, refer to the supplementary "CONTROL-A1 Control System" instructions.

- 3 Set the COMMAND MODE selector of each player. Set the COMMAND MODE selector of this player to CD 1 or CD 2, and set that of the second player to CD 3.

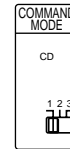

For details on how to operate the second player, see "Controlling Another CD Player" on page 18 and "Playing Alternately" on page 19.

- 4 Connect the AC power cord of both players to AC outlets.

Notes

- Do not connect a player other than that you use as the second player to the 2ND CD IN jacks of this player.
- When connecting a second CD player, do not connect the DIGITAL OUT (OPTICAL) connector of this unit to the amplifier.

Playing a CD

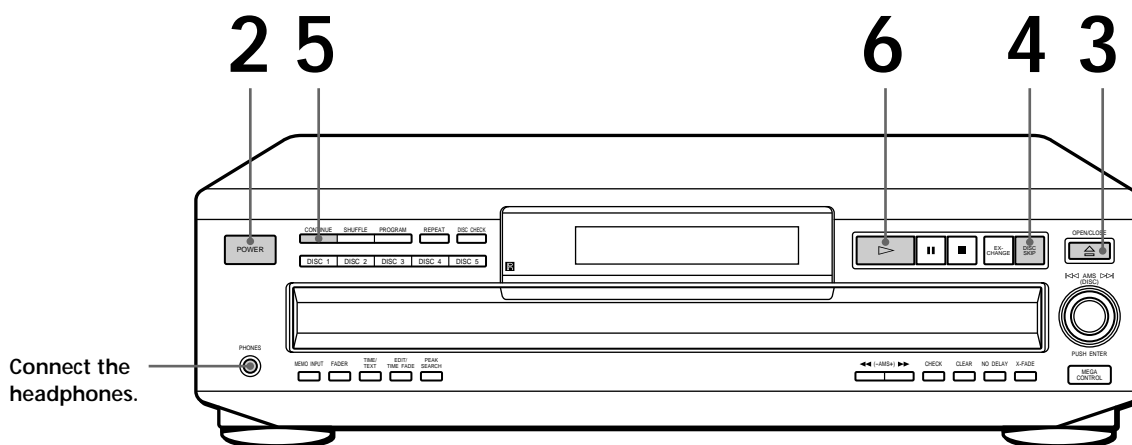

- See pages 4 – 5 for the hookup information.

- 1 Turn on the amplifier and select the CD player position so that you can listen to the sound from this player.
- 2 Press POWER to turn on the player.
- 3 Press OPEN/CLOSE, and place a disc on the disc tray.

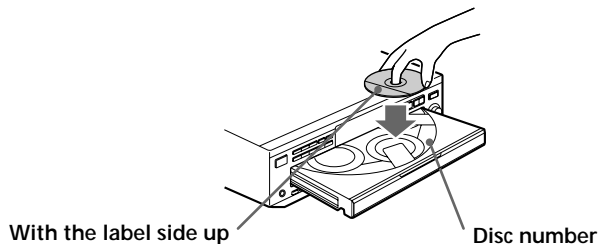

- 4 To place other discs, press DISC SKIP and place the discs in the order you want to play.
Each time you press the button, the disc tray turns and you can place the discs in the empty disc compartments. The player plays the disc in front of you first.
- 5 Press CONTINUE to select ALL DISCS or 1 DISC Continuous Play mode.
Each time you press the CONTINUE button, "ALL DISCS" or "1 DISC" appears in the display.

When you select	The player plays
ALL DISCS	All discs in the player consecutively in the order of disc number
1 DISC	Only the disc you've selected

You can select the disc you want to start playing first
 Press one of the DISC 1 – 5 buttons.

You can adjust the output level to the amplifier
 Press LINE OUT LEVEL +/- on the remote. You can reduce the output level up to -20 dB. When you reduce the output level, "FADE" appears in the display. The headphones volume will also change when you adjust the output level.

Note

If you press the LINE OUT LEVEL +/- buttons on the remote while recording, the recording level will change even when it is preset on the tape deck, etc.

6 Press ▷.
 The disc tray closes and the player plays all the tracks once (Continuous Play). Adjust the volume on the amplifier.

To stop playback

Press ■.

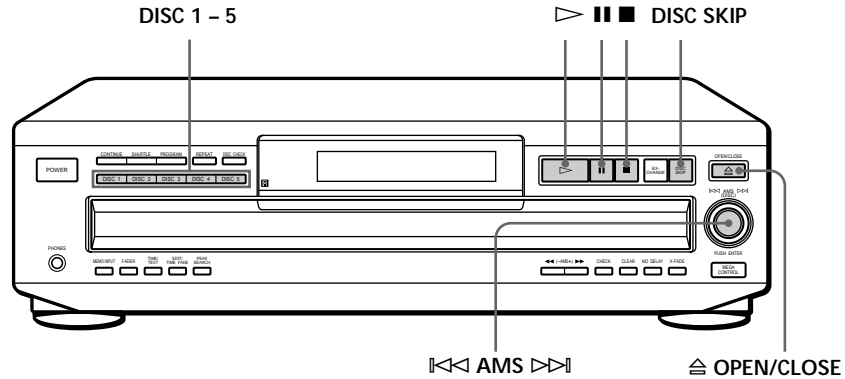

To	You need to
Pause	Press ■■
Resume play after pause	Press ■■ or ▷
Go to the next track	Turn ◀◀ AMS ▶▶ clockwise
Go back to the preceding track	Turn ◀◀ AMS ▶▶ counterclockwise
Go to the next disc	Press DISC SKIP
Select a disc directly	Press DISC 1 – 5
Stop play and remove the CD	Press ◻ OPEN/CLOSE

Using the Display

You can check information about the disc using the display.

CDP-CE515

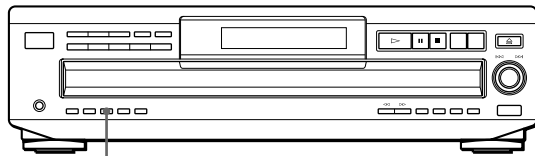

TIME/TEXT

CDP-C460Z

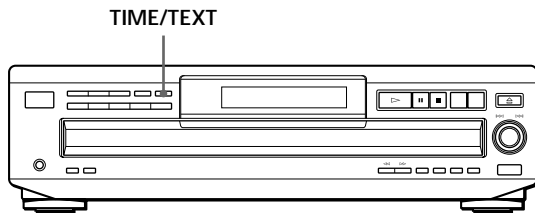

TIME/TEXT

Checking the total number and playing time of the tracks

Press TIME/TEXT before you start playing. The display shows the current disc number, the total number of tracks, total playing time and music calendar.

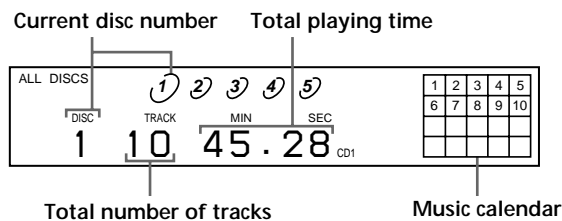

The information also appears when you press the \square OPEN/CLOSE button to close the disc tray. The tracks numbered over 20 cannot be displayed in the music calendar.

Notes on the disc number indications

- The red circle around a disc number indicates the disc is ready to be played.
- When all the tracks on a disc have been played, the semi-circle around the disc number disappears.
- When a disc compartment is recognized as empty, the semi-circled disc number disappears.

Display information while playing a disc

While playing a disc, the display shows the current disc number, track number, playing time of the track and the music calendar.

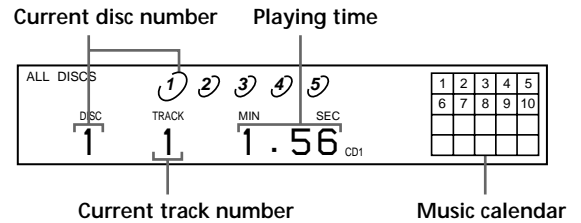

The track numbers in the music calendar disappear after they are played.

Checking the remaining time

Each time you press the TIME/TEXT button while playing a disc, the display changes as shown in the chart below.

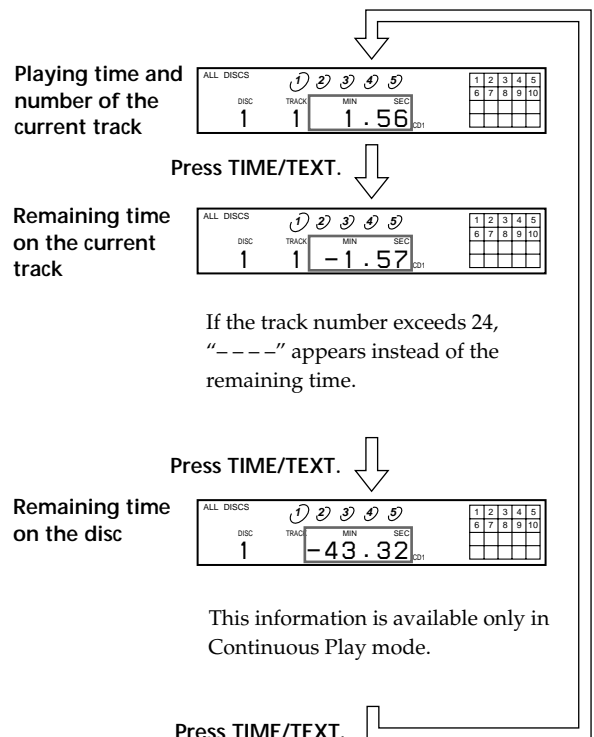

Checking the information of CD-TEXT discs

CD-TEXT discs have information, such as the disc titles or artist names, memorized in a blank space on the discs where there is no information on normal discs. The display shows the CD-TEXT information of the disc so that you can check the current disc title, artist name and track title. When the player detects CD-TEXT discs, the "CD-TEXT" indication lights up in the display. Each time you press the TIME/TEXT button, the display changes as shown in the charts below.

• Before you start playing

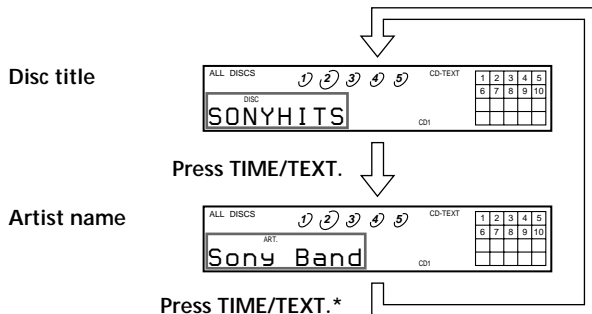

• While playing a disc

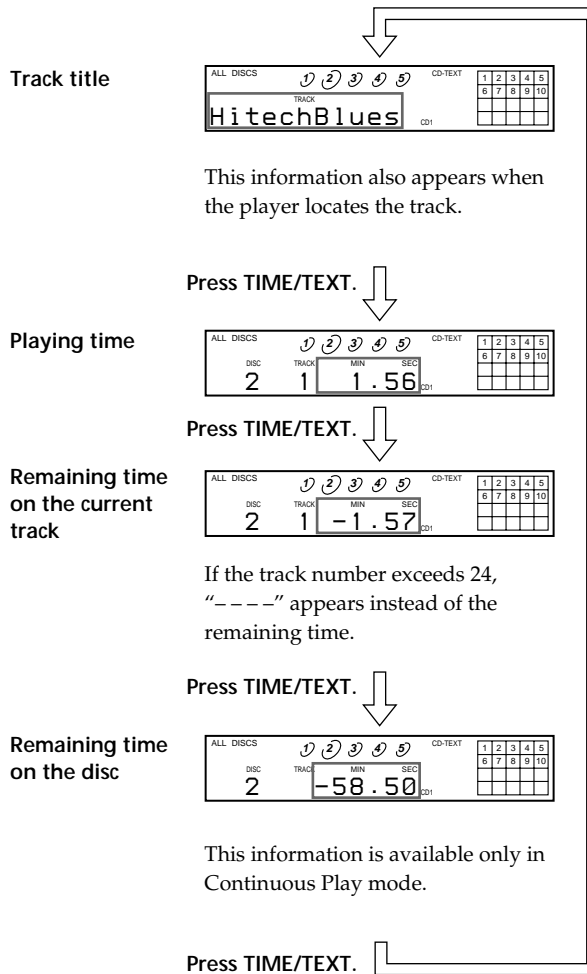

If each CD-TEXT information has more than 12 characters, the first 12 characters light up after all the characters scrolled in the display.

Note

This player can only display the disc titles, track titles and artist names from CD-TEXT discs. The other CD-TEXT information cannot be displayed.

To play disc highlights

Some CD-TEXT discs have a feature to play only the highlights of the discs.

Press HIGH-LIGHT on the remote to start playing disc highlights in the stop mode.

"HIGH LIGHT" flashes in the display while playing disc highlights.

If you press the HIGH-LIGHT button while selecting discs without this feature, "NO HIGHLIGHT" appears in the display.

Replacing Discs While Playing a Disc

You can open the disc tray while playing a disc so that you can check what discs are to be played next and replace discs without interrupting playback of the current disc.

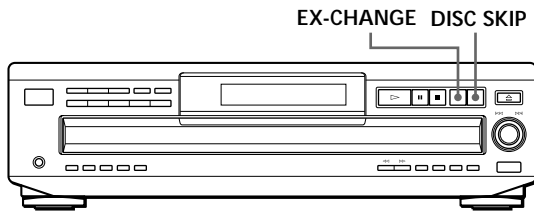

- 1 Press EX-CHANGE.
The disc tray opens and two disc compartments appear. Even if the player is playing a disc, it doesn't stop playing.
- 2 Replace discs in the compartments with new ones.
The player plays the disc on the left side compartment after the current disc, and then the one on the right side compartment.
- 3 Press DISC SKIP.
The disc tray turns and other two disc compartments appear.
- 4 Replace discs in the compartments with new ones.
- 5 Press EX-CHANGE.
The disc tray closes.

While the disc tray is open by pressing the EX-CHANGE button

- If the playback of the current disc ends, the player stops playing. If the disc is played in 1 DISC Repeat Play mode (see page 14), the current disc starts playing again.
- In ALL DISCS Shuffle Play mode (see page 14), tracks are reshuffled on the current disc.
- In Program Play mode (see page 15), only the tracks on the current disc are played.
- Do not push the disc tray to close it in Step 5, as you may damage the player.

Locating a Specific Disc

You can locate any disc before or while playing a disc.

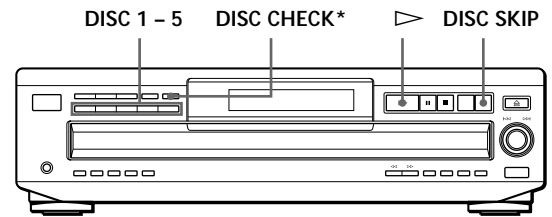

*CDP-CE515 only

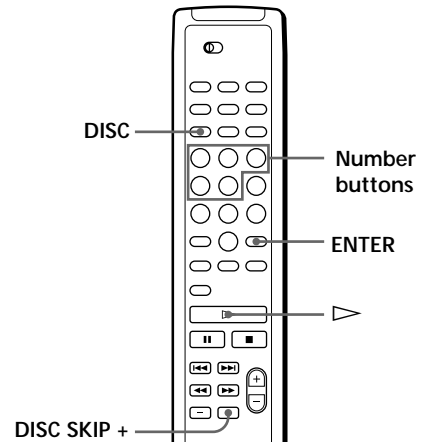



To locate	Press
The next disc	DISC SKIP while playing a disc. When using the remote, press DISC SKIP +.
A specific disc directly	DISC 1 - 5. When using the remote, follow the procedure below. 1 Press DISC. 2 Press the number button of the disc. 3 Press ENTER.
A disc while checking the labels (CDP-CE515 only)	DISC CHECK while the disc tray is open. The disc tray turns to show you each disc label. When the disc you want comes in front of you, press ▷ to start playing.
A disc by scanning the first track of each disc for 10 seconds (CDP-CE515 only)	DISC CHECK before you start playing while the disc tray is closed. When you find the disc you want, press ▷ to start playing.

💡 You can extend the playing time during scanning the discs

Press DISC CHECK repeatedly until the playing time you want (10, 20 or 30) appears in the display. Each time you press the button, the playing time changes cyclically.

Notes

- When you press the DISC CHECK button, the play mode automatically changes to ALL DISCS Continuous Play mode.
- When you've opened the disc tray by pressing the EX-CHANGE button, you cannot use the DISC CHECK function.
- Even if you press the DISC CHECK button while "REPEAT" appears in the display (see page 14), the player stops after scanning all the discs once.

To locate	You need to
The next or succeeding tracks	Turn ⏪ AMS ⏩ clockwise until you find the track. When using the remote, press ▶▶ repeatedly until you find the track.
The current or preceding tracks	Turn ⏪ AMS ⏩ counterclockwise until you find the track. When using the remote, press ◀◀ repeatedly until you find the track.
A specific track directly 	Press the number button of the track on the remote
A track by scanning each track for 10 seconds  (Music Scan)	Press MUSIC SCAN on the remote before you start playing. When you find the track you want, press ▷ to start playing.

Locating a Specific Track

You can quickly locate any track while playing a disc using the AMS (AMS: Automatic Music Sensor) control or number buttons on the remote.

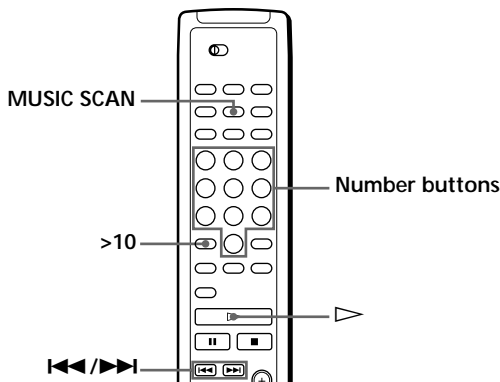
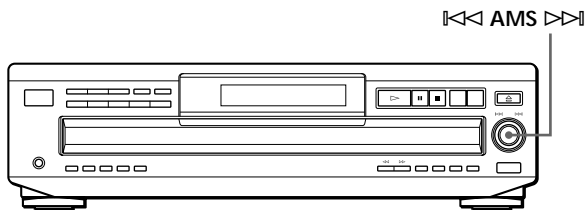

💡 When you directly locate a track numbered over 10 

Press >10 first, then the corresponding number buttons on the remote. To enter "0," use button 10.

Example: To play track number 30

Press >10 first, then 3 and 10.

💡 You can extend the playing time during Music Scan

Press MUSIC SCAN repeatedly until the playing time you want (10, 20 or 30) appears in the display. Each time you press the button, the playing time changes cyclically.

Locating a Particular Point in a Track

You can also locate a specific point in a track while playing a disc.

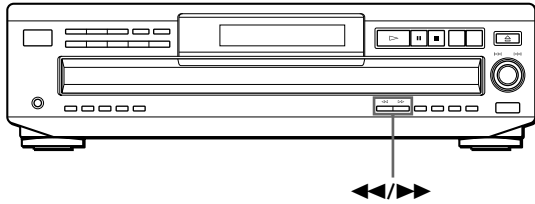

To locate	Press
A point while monitoring the sound	▶▶ (forward) or ◀◀ (backward) and hold down until you find the point
A point quickly by observing the display during pause	▶▶ (forward) or ◀◀ (backward) and hold down until you find the point. You will not hear the sound during the operation.

Note

If "OVER" appears in the display, the disc has reached the end while you were pressing the ▶▶ button. Press ◀◀ or turn AMS counter-clockwise to go back.

Playing Repeatedly

You can play discs/tracks repeatedly in any play mode.

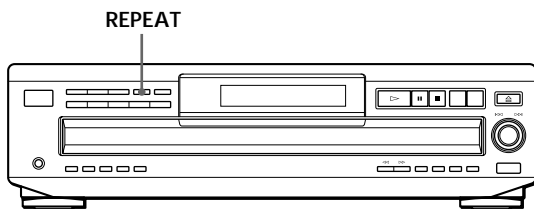

Press REPEAT while playing a disc. "REPEAT" appears in the display. The player repeats the discs/tracks as follows:

When the disc is played in	The player repeats
Continuous Play (ALL DISCS) (page 8)	All the tracks on all discs
Continuous Play (1 DISC) (page 8)	All the tracks on the current disc
Shuffle Play (ALL DISCS) (page 14)	All the tracks on all discs in random orders
Shuffle Play (1 DISC) (page 15)	All the tracks on the current disc in random orders
Program Play (page 15)	The same program

To cancel Repeat Play

Press REPEAT repeatedly until "REPEAT OFF" appears in the display.

Repeating the current track

You can repeat only the current track while the disc is played in any play mode.

While the track you want is being played, press REPEAT repeatedly until "REPEAT 1" appears in the display.

Playing in Random Order (Shuffle Play)

You can have the player "shuffle" tracks and play in a random order. The player shuffles all the tracks on all discs or on the disc you've specified.

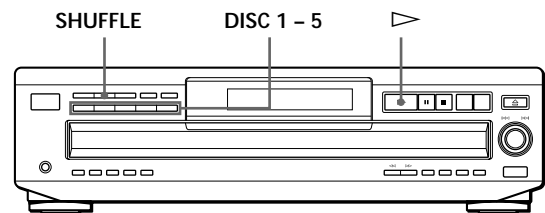

Shuffle Play on all discs

You can play all tracks on all discs in a random order.

- 1 Press SHUFFLE repeatedly until "ALL DISCS" appears in the display.
- 2 Press ▶ to start ALL DISCS Shuffle Play. The ◻◻◻◻◻ indication appears while the player is "shuffling" the tracks.

To cancel Shuffle Play

Press CONTINUE.



You can start Shuffle Play while playing

Press SHUFFLE, and Shuffle Play starts from the current track.



You can specify discs during Shuffle Play (Select Shuffle Play)

You can specify discs during ALL DISCS Shuffle Play mode, and the tracks on the specified discs are played in a random order.

Press DISC 1 – 5 to specify the discs after Step 1.

Semi-circles appear around the specified disc numbers in the display. To cancel the selected discs, press DISC 1 – 5 again. The semi-circles disappear.

To return to ALL DISCS Shuffle Play, press SHUFFLE twice.

Shuffle Play on one disc

You can play all tracks on the specific disc in a random order.

- 1 Press SHUFFLE repeatedly until "1 DISC" appears in the display.
- 2 Press DISC 1 – 5 to start 1 DISC Shuffle Play on the selected disc.
The  indication appears while the player is "shuffling" the tracks.

To cancel Shuffle Play

Press CONTINUE.



You can start Shuffle Play while playing

Press SHUFFLE, and Shuffle Play starts from the current track.

Creating Your Own Program (Program Play)

You can arrange the order of the tracks on the discs and create your own program. The program can contain up to 32 "steps" — one "step" may contain a track or a whole disc.

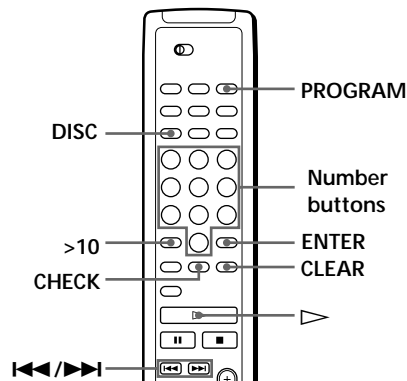
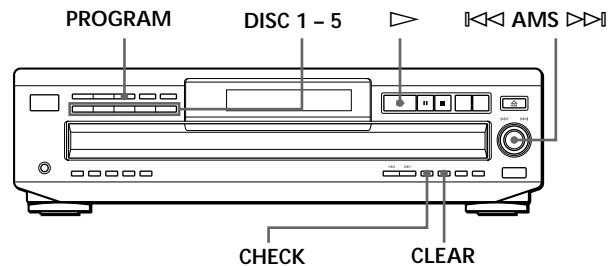

Creating a program on the player

- 1 Press PROGRAM.
"PROGRAM" appears in the display.
If a program is already stored, the last step of the program appears in the display. When you want to erase the whole program, hold down CLEAR until "ALL CLEAR" appears in the display (see page 17).
- 2 Press DISC 1 – 5 to select the disc.

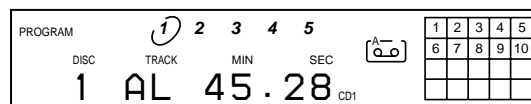

"AL" in the display stands for "all" tracks.
When you want to program the whole disc as one step, skip Steps 3 to 4, and go to Step 5.

(Continued)

- 3** Turn **◀◀ AMS ▶▶** until the track number you want appears in the display. The track number being programmed flashes and the total playing time including the track appears in the display.

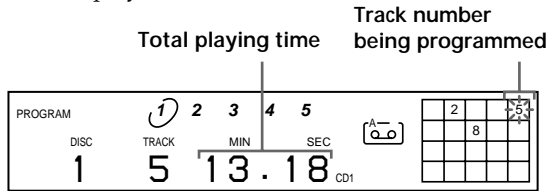

- 4** Push **◀◀ AMS ▶▶** to select the track.

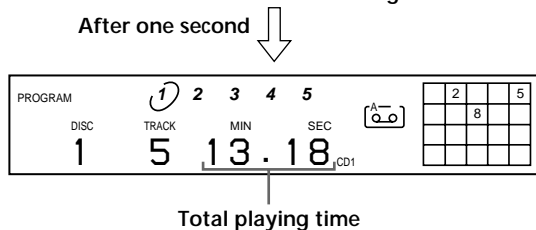
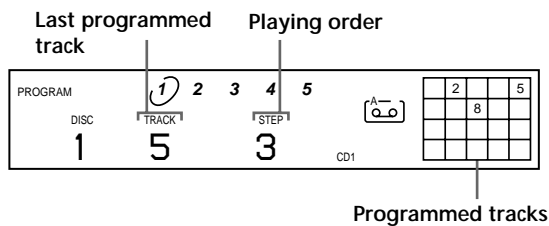

If you've made a mistake

Press CLEAR, then repeat Steps 3 and 4.

- 5** To program other discs or tracks, do the following:

To program	Repeat Step(s)
Other discs	2
Other tracks on the same disc	3 and 4
Other tracks on other discs	2 through 4

- 6** Press **▷** to start Program Play.

To cancel Program Play

Press CONTINUE.

You can create your program while checking the disc labels

While the disc tray is open, follow Steps 1 to 6 with pressing the DISC SKIP button to check the disc labels. If you close the disc tray before Step 6, the total playing time appears in the display after a while.

Note that, if the programmed track number isn't found on the disc, that step is automatically erased.

The program remains even after the Program Play ends

When you press the **▷** button, you can play the same program again.

The program remains until you erase it or turn off the player

If you replace discs, the programmed disc and track numbers remain. So, the player plays only the existing disc and track numbers. However, the disc and track numbers that aren't found in the player or on the disc are deleted from the program, and the rest of the program is played in the programmed order.

Note

The total playing time doesn't appear when:

- You have programmed a track whose number exceeds 20.
- The total playing time of the program exceeds 200 minutes.

Creating a program using the remote

- 1** Press PROGRAM. "PROGRAM" appears in the display.

- 2** Press DISC.

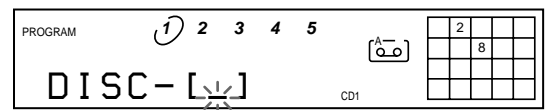

- 3** Press the number button of the disc.

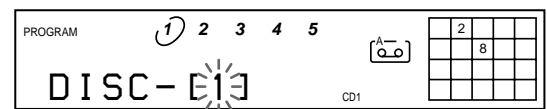

- 4** Press ENTER to select the disc.

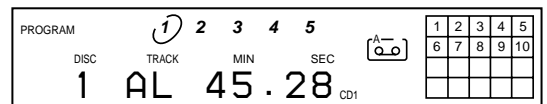

When you want to program the whole disc as one step, skip Steps 5 to 6, and go to Step 7.

- 5** Press **◀◀ / ▶▶** until the track number you want appears in the display.

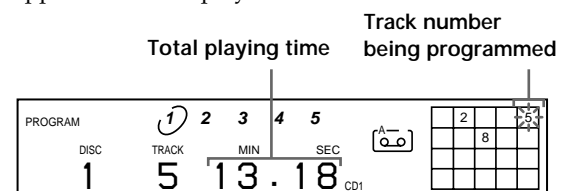

6 Press ENTER to select the track.

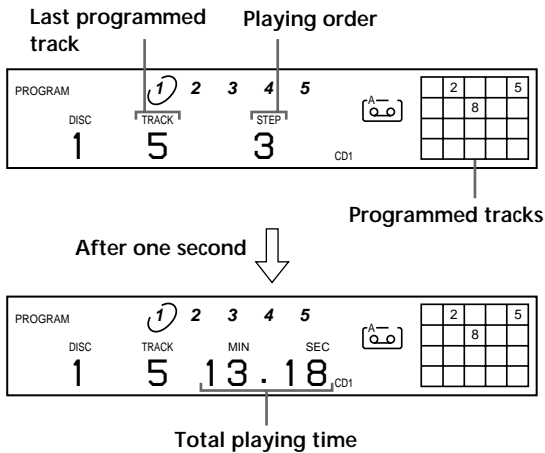

7 To program other discs or tracks, do the following:

To program	Repeat Steps
Other discs	2 through 4
Other tracks on the same disc	5 and 6
Other tracks on other discs	2 through 6

8 Press \blacktriangleright to start Program Play.

To cancel Program Play

Press CONTINUE.

💡 You can select a track directly using the number buttons

Press the number button of the track in Step 5. To select a track numbered over 10, use the >10 button (see page 13).

💡 You can create your program while checking the disc labels

While the disc tray is open, follow Steps 1 to 8 with pressing the DISC SKIP button to check the disc labels. If you close the disc tray before Step 8, the total playing time appears in the display after a while.

Note that, if the programmed track number isn't found on the disc, that step is automatically erased.

Note

The total playing time doesn't appear when:

- You have programmed a track whose number exceeds 20.
- The total playing time of the program exceeds 200 minutes.

Checking the track order

You can check your program before or after you start playing.

Press CHECK.

Each time you press this button, the display shows the track (the disc and track numbers) or the disc (the disc number and "AL" indication) of each step in the programmed order. After the last step in the program, the display shows "END" and returns to the original display. If you check the order after you start playing, the display shows only the remaining steps.

Changing the track order

You can change your program before you start playing.

To	You need to
Erase a track	Press CHECK until the track you don't want appears in the display, then press CLEAR
Erase the last track in the program	Press CLEAR. Each time you press the button, the last track will be cleared.
Add tracks to the end of the program	Follow the programming procedure
Change the whole program completely	Hold down CLEAR until "ALL CLEAR" appears in the display. Create a new program following the programming procedure.

Controlling Another CD Player (Mega Control)

This unit can control a second CD player (see "Connecting Another CD Player" on pages 6 and 7). Even when a second CD player is connected, the controls on both of the units will function. When you press the play button on either unit, the operating player stops and the resting player starts.

The controls indicated in the illustration below are effective while the MEGA CONTROL button is lit.

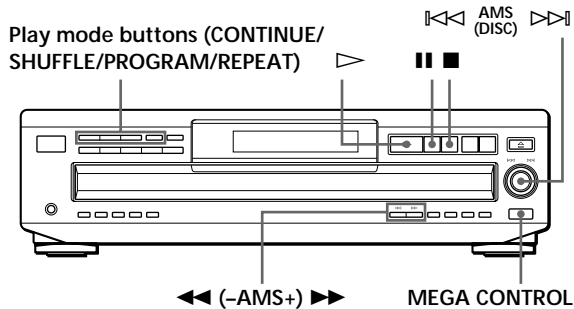

- 1 Press MEGA CONTROL on this player. The MEGA CONTROL button lights up and the display shows the current disc number of the second player.

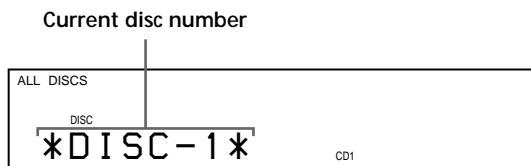

- 2 Select the play mode you want. To program tracks, use the controls on the second player.
- 3 Press ▷ on this player to start playing. The play starts and the display shows the current disc and track numbers and the playing time of the track. While the MEGA CONTROL button is lit, you can control the second player with the controls on this player as follows:

To	You need to
Pause	Press
Stop play	Press ■
Locate a disc while the second player is set to Continuous Play mode	Turn ◀◀ ^{AMS (DISC)} ▶▶ until the display shows the disc number you want, then push ◀◀ ^{AMS (DISC)} ▶▶
Locate a track	Press ◀◀ (-AMS+) ▶▶ until the display shows the track number you want

- To do other operations, use the controls on the second player or the supplied remote.
- The AMS buttons (**◀◀** / **▶▶**) and search buttons (**◀◀** / **▶▶**) on the remote operate the second player as indicated on the remote.

To control the second player directly using the supplied remote

Set CD 1/2/3 on the remote to CD 3 which is the same position as the COMMAND MODE selector on the rear panel of the second player.

To control this player again

Press MEGA CONTROL. The MEGA CONTROL button goes off and you can control this player.

Notes

- You cannot locate a particular point in a track of the second player using the controls on this player.
- Some controls on this player work on the second player differently from they do to this player.

Playing Alternately (No-Delay Play/X-Fade Play)

When you connect the second player, you can play tracks in this player and those in the second player alternately in any play mode (see “Connecting Another CD Player” on pages 6 and 7).

Select one of the following methods:

- **No-Delay Play:** The current player changes at each track. Each time the current player changes to the other player, the other player starts play without a break in sound immediately after the current player ends play. The other player skips the lead-in portion and starts playing from where the sound actually begins.
- **X-Fade Play:** The current player changes at each track or at the specified interval. You can select the interval among 30, 60 and 90 seconds. Each time the current player changes to the other player, the sound from both players is mixed. The current player ends play by fading out, and the other player starts play by fading in.

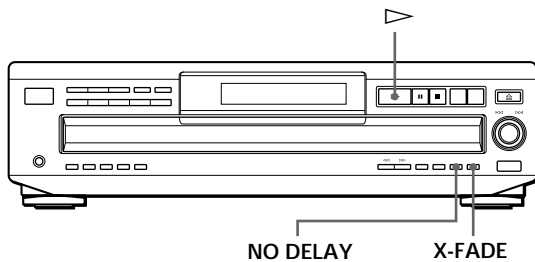

1 Select the play mode you want on each player.

2 When you select No-Delay Play

Press NO DELAY.

The NO DELAY button lights up.

When you select X-Fade Play

Press X-FADE.

The X-FADE button lights up.

Each time you press the X-FADE button, the indication appears as follows:

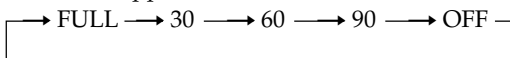

To change the current player each time a whole track is finished, select “FULL.”

To change the current player at the specified interval, press X-FADE repeatedly until the interval you want appears in the display.

3 Press ▷ to start playing.

The MEGA CONTROL button lights up while the track in the second player is selected.

To cancel No-Delay/X-Fade Play

Press the corresponding button repeatedly until the button goes off. The current player continues playing.

You can change the method (No-Delay or X-Fade) during play

Press the corresponding button (NO DELAY or X-FADE) following the procedure in Step 2 above.

Notes

- The play starts from the second player if you start play while the MEGA CONTROL button is lit.
- When one player has played all the discs/tracks in the player ahead of the other player, the play stops.
- Do not use the controls on the second player during No-Delay/X-Fade Play. They may not work correctly.

Recording Your Own Program

You can record the program you've created on a tape, etc. The program can contain up to 32 steps. By inserting a pause during programming, you can divide the program into two for recording on both sides of a tape.

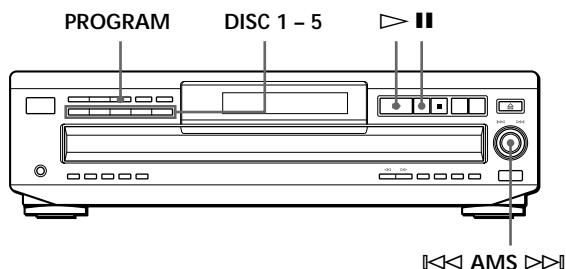

- 1 Create your program (for side A when recording on a tape) while checking the total playing time indicated in the display. Follow Steps 1 through 5 in "Creating a program on the player" on page 15. The indication appears in the display.

- 2 When you record on both sides of the tape, press to insert a pause. The "PAUSE" and indications appear in the display and the playing time is reset to "0.00." When you record on one side of the tape, skip this step and go to Step 4.

A pause is counted as one step

You can program up to 31 steps when you insert a pause.

- 3 Repeat Steps 2 through 5 in "Creating a program on the player" to create the program for side B.
- 4 Start recording on the deck and then press on the player. When you record on both sides of the tape, the player pauses at the end of the program for side A.
- 5 When you record on side B, reverse the tape and press or on the player to resume playing.

To check and change your program

See page 17.

The indication appears while checking the program for side A and while checking the program for side B.

Recording a CD by Specifying Tape Length (Time Edit) (CDP-CE515 only)

You can have the player create a program that will fit the length of the tape.

The player automatically creates a program, keeping the original order of the disc.

The program can contain up to 32 steps (a pause inserted between steps is counted as one step). Note that tracks numbered over 20 cannot be programmed automatically.

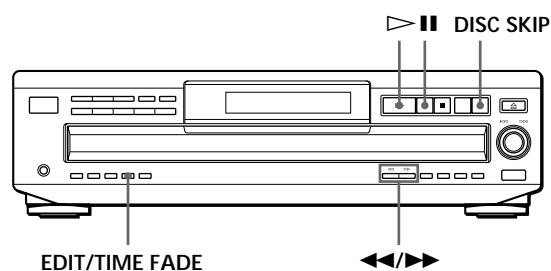

- 1 Press DISC SKIP to select the disc.
- 2 Press EDIT/TIME FADE repeatedly before you start playing until "EDIT" appears and "A" in the indication flashes in the display.

- 3 Press or to specify the tape length. Each time you press these buttons, the display changes as shown below with the tape length of one side.

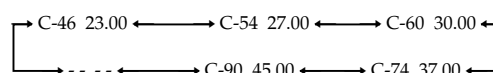

- 4 Press EDIT/TIME FADE to have the player create the program. The display shows the tracks to be recorded. "B" in the indication flashes in the display.

- 5 When you record on both sides of the tape, press EDIT/TIME FADE again. The player inserts a pause, then creates the program for side B. The display shows the programmed tracks. When you record on one side of the tape, skip this step.

- 6 Start recording on the deck and then press on the player. When you record on both sides of the tape, the player pauses at the end of the program for side A.

- 7 When you record on side B, reverse the tape and press \triangleright or \parallel on the player to resume playing.

To cancel Time Edit

Press CONTINUE.

You can program the tracks you want in advance

Select the tracks before doing the above procedure. The player creates a program from the remaining tracks.

You can freely specify the tape length

Set the tape length using the $\parallel \lll \text{AMS} \ggg \parallel$ control.

Example: When the tape length of one side is 30 minutes and 15 seconds

- 1 To set the minutes, turn $\parallel \lll \text{AMS} \ggg \parallel$ until "30" appears in the display, then push $\parallel \lll \text{AMS} \ggg \parallel$.
- 2 To set the seconds, turn $\parallel \lll \text{AMS} \ggg \parallel$ until "15" appears in the display, then push $\parallel \lll \text{AMS} \ggg \parallel$.

You can check and change the program

See page 17.

Fading In or Out

You can manually fade the sound in or out to prevent tracks from starting or ending abruptly.

Note that you cannot use this effect when you use the DIGITAL OUT (OPTICAL) connector.

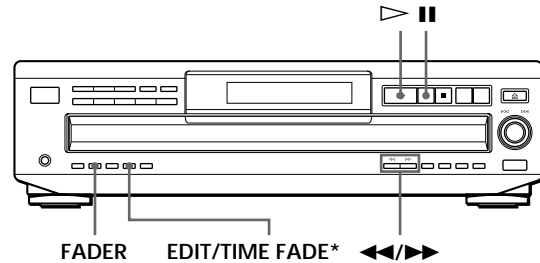

*CDP-CE515 only

To	Press FADER
Start play fading in	During pause. $\boxed{\text{FADE}}$ lights up in the display and the \parallel indication flashes. The play fades in.
End play fading out	When you want to start fading out. $\boxed{\text{FADE}}$ lights up in the display and the \parallel indication flashes. The play fades out and the player pauses.

Note

Fading lasts for about 5 seconds. However, when you press the FADER button during Music Scan (see page 13), the play fades out for about 2 seconds.



Changing the fading time

You can change the fading time from 2 to 10 seconds before fading in or out. If you don't change it, fading lasts for 5 seconds.

- 1 Press FADER before you start playing. "FADE 5 SEC" appears in the display.
- 2 Press $\lll \ggg$ to specify the fading time.

Fading out at the specified time (Time Fade) (CDP-CE515 only)

You can have the player fade out automatically by specifying the playing time. Once you set the Time Fade, it works twice, that is, the play fades out at the end of both sides of a tape.

- 1 Press EDIT/TIME FADE repeatedly before you start playing until  and "A" in the  indication appear in the display.
- 2 Press ◀◀ or ▶▶ to specify the playing time. Each time you press these buttons, the display changes as shown below with the playing time of one side.

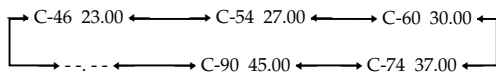

- 3 Press ▷ to start playing. At the specified time the play fades out and the player pauses. "B" in the  indication appears in the display.
- 4 To record on side B, reverse the tape and press ▷ or || on the player to resume playing. Again, the play fades out at the specified time.

To cancel Time Fade

Press EDIT/TIME FADE.

You can freely specify the playing time

See "You can freely specify the tape length" on page 21.

You can change discs during Time Fade

If the play ends before the specified fade-out time, (for example, when you record CD-singles on a tape) change the disc. The specified fade-out time is counted only during playing.

You can fade in to resume playing in Step 4

After you reverse the tape, press FADER.

Note

If you press the ◀◀ or ▶▶ button during Time Fade Play, Time Fade will be cancelled.

Adjusting the Recording Level (Peak Search) (CDP-CE515 only)

The player locates the highest level among the tracks to be recorded to let you adjust the recording level before you start recording.

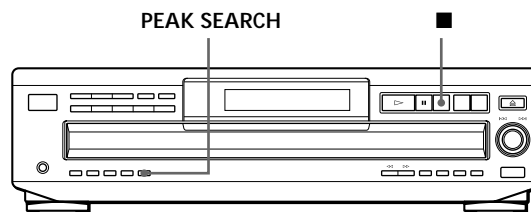

- 1 Before you start playing, press PEAK SEARCH. "PEAK" flashes in the display and the player repeats the portion of the highest level.
- 2 Adjust the recording level on the deck.
- 3 Press ■ on the player to stop Peak Search. "PEAK" disappears from the display.

Notes

- The portion with the highest level may differ every time you try the adjustment on the same disc. The difference is, however, so slight that you won't find any problem in adjusting the recording level precisely.
- Peak Search does not operate while you open the disc tray by pressing the EX-CHANGE button.

What You Can Do With the Custom Files

The player can store two types of information called “Custom Files” for each disc. Once you have stored Custom Files for a disc, the player automatically recalls what you have stored whenever you select the disc. Note that Custom Files will be erased if you do not use the player for about one month.

You can store this information:

When you use	You can
Disc Memo (page 23)	Label discs using up to 12 characters
Delete Bank (page 25)	Delete unwanted tracks and store only the tracks you want

Where are Custom Files stored?

Custom Files are stored not on the disc, but in the player’s memory. It means you cannot use Custom Files when you play the disc on other players.

Erasing all Custom Files of all discs

Turn off the player. While holding down CLEAR, press POWER to turn on the player. “ALL ERASE” appears in the display, and all Custom Files will be erased.

Labeling Discs (Disc Memo)

You can label discs using up to 12 characters and have the player display the Disc Memo each time you select the disc. The Disc Memo can be anything you like, such as a title, musician’s name, category or date of purchase.

When you select a CD-TEXT disc

The disc title is stored as the Disc Memo automatically. If the disc title has more than 12 characters, the first 12 characters of the disc title are stored (see page 11). Note that you cannot change the Disc Memo of the CD-TEXT disc.

Labeling discs on the player

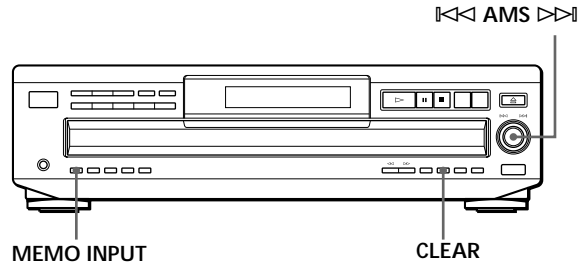

- 1 Insert or select the disc.
- 2 Press MEMO INPUT. The flashing cursor (◀) appears.
- 3 Turn ◀◀ AMS ▶▶ until the character you want appears in the display. The cursor disappears and the first space for the Disc Memo flashes. As you turn ◀◀ AMS ▶▶ clockwise, the characters appear in the following order. Turn ◀◀ AMS ▶▶ counterclockwise to go back to the previous character.

(space) A B C D E F G H I J K L M N O P Q R S T U
 V W X Y Z a b c d e f g h i j k l m n o p q r s t u v w
 x y z 0 1 2 3 4 5 6 7 8 9 ! " # \$ % & ' () * + , - . / : ; <
 = > ? @ [\] ^ _ | { | } -

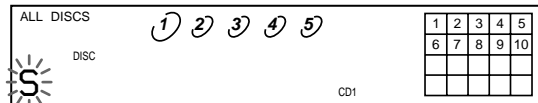

- 4 Push ◀◀ AMS ▶▶ to select the character. The selected character lights up, and the flashing cursor appears to indicate the next space to be input.

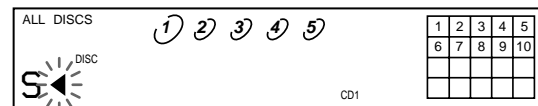

If you have made a mistake

Press CLEAR and begin again by inputting the correct characters.

- 5 Repeat Steps 3 and 4 to input more characters.

(Continued)

Storing Information About CDs (Custom Files)

- Press MEMO INPUT to store the Disc Memo. The Disc Memo lights up in the display.

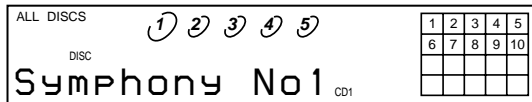

Repeat Steps 1 to 6 to assign Disc Memos to other discs.

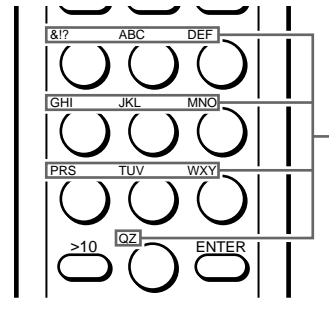

Characters assigned to each number button

Labeling discs using the remote

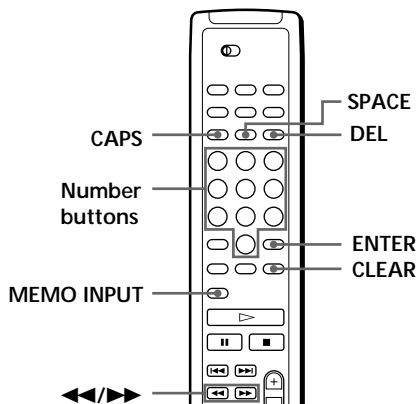

Example: To select the letter E
Press the number button 3 twice.

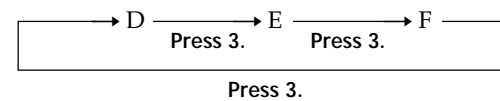

To insert a space, press SPACE once.

To input a number, press CAPS twice in Step 4, then press the number button you want.

To input symbols, press the number button 1 repeatedly until the symbol you want appears in the display.

- Press CAPS.
- Press the number button of the disc you want to assign a Disc Memo, and then ENTER.
- Press MEMO INPUT. The flashing cursor (◀) appears.
- Press CAPS to find the letter type you want. Each time you press the button, the letter type changes cyclically among capital letters (ABC), small letters (abc) and numbers (123).
- Press the number button corresponding to the character you want (indicated beside each number button). The cursor disappears and the first space for the Disc Memo flashes. Each time you press the button, the character changes cyclically among the ones indicated beside the button.

- Press ENTER to select the character. The selected character lights up, and the flashing cursor appears to indicate the next space to be input. You can also go to the next space by pressing other number buttons.
- Repeat Steps 4 through 6 to input more characters.
- Press MEMO INPUT to store the Disc Memo. The Disc Memo lights up in the display.

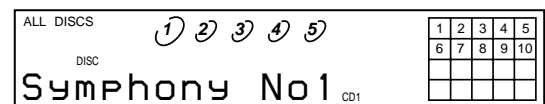

Repeat Steps 1 through 8 to assign Disc Memos to other discs.

💡 If you have made a mistake while inputting the character

To correct the character which has been input

- 1 Press ◀ or ▶ until the cursor moves next to the incorrect character.

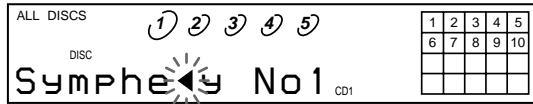

- 2 Press DEL to delete the incorrect character.

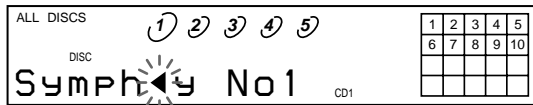

- 3 Input the correct character.

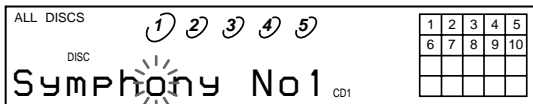

To correct the character currently being input

- 1 Press DEL to delete the incorrect character.
- 2 Input the correct character.

To insert a character between the input characters

Press ◀ or ▶ until the cursor moves next to the point you want to insert, and enter the character.

Erasing the Disc Memo

- 1 Follow Steps 1 and 2 in "Labeling discs on the player" on page 23 to select the Disc Memo you want to erase.
- 2 Press CLEAR.
The Disc Memo disappears.
- 3 Press MEMO INPUT.

Storing Specific Tracks (Delete Bank)

You can delete unwanted tracks and store only the tracks you want. When you select the disc containing a Delete Bank, you can play only the remaining tracks.

CONTINUE SHUFFLE

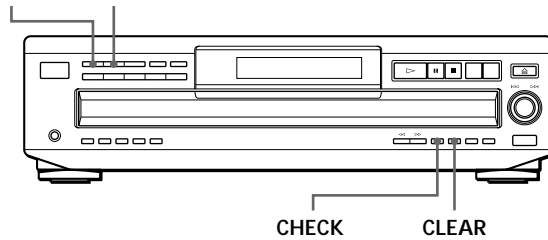

- 1 Insert or select the disc.
- 2 Press CONTINUE or SHUFFLE before you start playing.
- 3 Press CHECK repeatedly until the track you want to delete appears in the display.

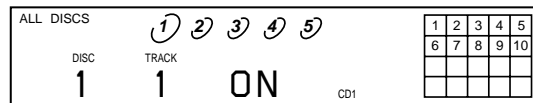

- 4 Press CLEAR.
"DELETE" and "OFF" appear in the display.

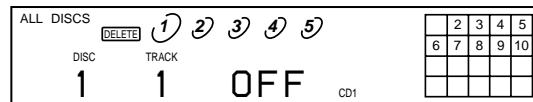

If you want to recover the track, press CLEAR again.

- 5 Repeat Steps 3 and 4 to delete more tracks.

💡 You can recover all the tracks you have deleted

Hold down CLEAR until "ALL SELECT" appears in the display.

Note

The deleted tracks are skipped even in the Shuffle or Program Play mode (when the whole disc containing a Delete Bank is programmed as one step).

Precautions

On safety

- Caution — The use of optical instruments with this product will increase eye hazard.
- Should any solid object or liquid fall into the cabinet, unplug the player and have it checked by qualified personnel before operating it any further.

On power sources

- Before operating the player, check that the operating voltage of the player is identical with your local power supply. The operating voltage is indicated on the nameplate at the rear of the player.
- The player is not disconnected from the AC power source (mains) as long as it is connected to the wall outlet, even if the player itself has been turned off.
- If you are not going to use the player for a long time, be sure to disconnect the player from the wall outlet. To disconnect the AC power cord (mains lead), grasp the plug itself; never pull the cord.
- AC power cord must be changed only at the qualified service shop.

On placement

- Place the player in a location with adequate ventilation to prevent heat build-up in the player.
- Do not place the player on a soft surface such as a rug that might block the ventilation holes on the bottom.
- Do not place the player in a location near heat sources, or in a place subject to direct sunlight, excessive dust or mechanical shock.

On operation

- If the player is brought directly from a cold to a warm location, or is placed in a very damp room, moisture may condense on the lenses inside the player. Should this occur, the player may not operate properly. In this case, remove the disc and leave the player turned on for about an hour until the moisture evaporates.

On adjusting volume

- Do not turn up the volume while listening to a portion with very low level inputs or no audio signals. If you do, the speakers may be damaged when a peak level portion is played.

On cleaning

- Clean the cabinet, panel and controls with a soft cloth slightly moistened with a mild detergent solution. Do not use any type of abrasive pad, scouring powder or solvent such as alcohol or benzine.

If you have any questions or problems concerning your player, please consult your nearest Sony dealer.

Notes on CDs

On handling CDs

- To keep the disc clean, handle the disc by its edge. Do not touch the surface.
- Do not stick paper or tape on the disc.

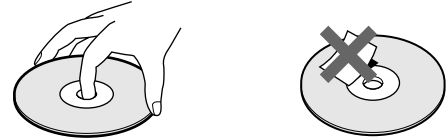

Not this way

- Do not expose the disc to direct sunlight or heat sources such as hot air ducts, nor leave it in a car parked in direct sunlight as there can be considerable rise in temperature inside the car.
- Do not use any commercially available stabilizer. If you do, the disc and the player may be damaged.
- After playing, store the disc in its case.

On cleaning

- Before playing, clean the disc with a cleaning cloth. Wipe the disc from the center out.

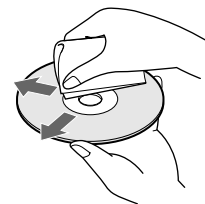

- Do not use solvents such as benzine, thinner, commercially available cleaners or anti-static spray intended for vinyl LPs.

Troubleshooting

If you experience any of the following difficulties while using the player, use this troubleshooting guide to help you remedy the problem. Should any problem persist, consult your nearest Sony dealer.

There's no sound.

- ➔ Check that the player is connected securely.
- ➔ Make sure you operate the amplifier correctly.
- ➔ Adjust the playback level using the LINE OUT LEVEL +/- buttons on the remote.

The CD does not play.

- ➔ There's no CD inside the player ("NO DISC" appears). Insert a CD.
- ➔ Place the CD with the label side up on the disc tray correctly.
- ➔ Clean the CD (see page 26).
- ➔ Moisture has condensed inside the player. Remove the disc and leave the player turned on for about an hour (see page 26).
- ➔ Place the CD in the correct position on the disc tray.

The remote does not function.

- ➔ Remove the obstacles in the path of the remote and the player.
- ➔ Point the remote at the remote sensor  on the player.
- ➔ Replace all the batteries in the remote with new ones if they are weak.
- ➔ Set the CD 1/2/3 switch on the remote according to the position of the COMMAND MODE selector at the rear panel of the player.

The player functions incorrectly.

- ➔ The microcomputer chips may be operating incorrectly. Turn the power off, then turn it back on to reset the player.

Specifications

Compact disc player

Laser	Semiconductor laser ($\lambda = 780 \text{ nm}$) Emission duration: continuous
Laser output	Max 44.6 μW * * This output is the value measured at a distance of 200 mm from the objective lens surface on the Optical Pick-up block with 7 mm aperture.
Frequency response	2 Hz to 20 kHz $\pm 0.5 \text{ dB}$
Signal-to-noise ratio	More than 107 dB
Dynamic range	More than 98 dB
Harmonic distortion	Less than 0.0035%

Output

	Jack type	Maximum output level	Load impedance
LINE OUT	Phono jacks	2 V (at 50 kilohms)	Over 10 kilohms
DIGITAL OUT (OPTICAL)	Optical output connector	-18 dBm	Wave length: 660 nm
PHONES	Stereo phone jack	10 mW	32 ohms

General

Power requirements

Where purchased	Power requirements
USA/Canada	120 V AC, 60 Hz
Europe	220 V - 230 V AC, 50/60 Hz
Australia	240 V AC, 50/60 Hz

Power consumption	14 W
Dimensions (approx.) (w/h/d)	430 × 120 × 393 mm (17 × 4 3/4 × 15 1/2 in.) incl. projecting parts
Mass (approx.)	5.4 kg (11 lbs 15 oz)

Supplied accessories

- Audio cord (2 phono plugs - 2 phono plugs) (1)
- Remote commander (remote) (1)
- Sony SUM-3 (NS) batteries (2)

Design and specifications are subject to change without notice.

Index

A, B

- AMS 13
- Automatic Music Sensor. *See* AMS

C, D

- CD-TEXT 11
- Connecting 4
 - another CD player 6
- Continuous Play 8
- Controlling another CD player 18
- X-Fade Play 19
- Custom Files
 - Delete Bank 25
 - Disc Memo 23
 - what you can do with 23

E

- Editing. *See* Recording
- Erasing
 - Custom Files 23
 - Delete Bank 25
 - Disc Memo 25

F, G

- Fading 21
 - Time Fade 22

H, I, J, K

- Handling CDs 26
- Hookups 4
 - overview 4

L

- Labeling a disc 23
- Locating
 - by monitoring 14
 - by observing the display 14
 - by scanning 13
 - directly 13
 - using AMS 13
 - while checking the labels 12

M

- Mega Control 18
- Music Scan 13

N, O

- No-Delay Play 19

P, Q

- Peak Search 22
- Playback
 - Continuous Play 8
 - X-Fade Play 19
 - No-Delay Play 19
 - Playing alternately 19
 - Program Play 15
 - Repeat Play 14
 - Shuffle Play 14

- Program 15
 - changing 17
 - checking 17
 - for recording 20

R

- Recording 20
 - a program 20
 - using Time Edit 20
- Remaining time 10
- Remote control 4
- Repeating 14
- Replacing discs while playing a disc 12

S

- Scanning. *See* Music Scan
- Searching. *See* Locating
- Select Shuffle Play 15
- Shuffle Play 14
- Storing
 - information about CDs 23
 - specific tracks 25

T

- Time Edit 20
- Time Fade 22
- Total playing time 10
- Troubleshooting 27

U, V, W, X, Y, Z

- Unpacking 4

Names of controls

Buttons

- CAPS 24
- CHECK 17
- CLEAR 17
- CONTINUE 8
- X-FADE 19
- DISC 12
- DISC 1-5 12
- DISC CHECK 12
- DISC SKIP 12
- EDIT/TIME FADE 20, 22
- ENTER 12
- EX-CHANGE 12
- FADER 21
- HIGH-LIGHT 11
- LINE OUT LEVEL +/- 5
- MEGA CONTROL 18
- MEMO INPUT 23
- MUSIC SCAN 13
- NO DELAY 19
- Number 13
- ⏏ OPEN/CLOSE 8
- PEAK SEARCH 22
- PROGRAM 15
- REPEAT 14
- SHUFFLE 14
- TIME/TEXT 10
- ▷ 9
- ⏏ 9
- 9
- ◀/▶ 14
- ◀◀(-AMS+)▶▶ 18
- ◀◀/▶▶ 13
- > 10 13

Control

- ◀◀ ^{AMS} (DISC) ▶▶ 13, 18

Jack

- PHONES 8

Switch

- POWER 8

Others

- Disc tray 8
- Display 10
- ⏏ 4