

Trinitron[®] Color TV

Operating Instructions

*KV-27S20
KV-27V20
KV-29PS1
KV-29RS20
KV-29RS20C
KV-29SD1
KV-29V20M
KV-32S20
KV-34RS20C*



WARNING

To prevent fire or shock hazard, do not expose the television to rain or moisture.

CAUTION
RISK OF ELECTRIC SHOCK
DO NOT OPEN

ATTENTION
RISQUE DE CHOC ELECTRIQUE,
NE PAS OUVRIR

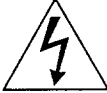
PRECAUCION
RIESGO DE CHOQUE ELECTRICO
NO ABRIR

CAUTION : TO REDUCE THE RISK OF ELECTRIC SHOCK,
DO NOT REMOVE COVER (OR BACK).
NO USER-SERVICEABLE PARTS INSIDE.
REFER SERVICING TO QUALIFIED SERVICE PERSONNEL.



This symbol is intended to alert the user to the presence of uninsulated "dangerous voltage" within the product's enclosure that may be of sufficient magnitude to constitute a risk of electric shock to persons.



This symbol is intended to alert the user to the presence of important operating and maintenance (servicing) instructions in the literature accompanying the appliance.

CAUTION

To prevent electric shock, do not use this polarized AC plug with an extension cord, receptacle or other outlet unless the blades can be fully inserted to prevent blade exposure.

Precautions

Safety

- Operate the TV only on 120 V AC (except KV-29RS20C/34RS20C).
- Operate the TV only on 220 V AC (KV-29RS20C/34RS20C only).
- One blade of the plug is wider than the other for safety purposes and will fit into the power outlet only one way. If you are unable to insert the plug fully into the outlet, contact your dealer (except KV-29RS20C/34RS20C).
- Should any liquid or solid object fall into the cabinet, unplug the TV and have it checked by qualified personnel before operating it any further.
- Unplug the TV from the wall outlet if you are not going to use it for several days or more. To disconnect the cord, pull it out by the plug. Never pull the cord itself.

For details concerning safety precautions, see the supplied leaflet "IMPORTANT SAFEGUARDS."

Installing

- To prevent internal heat build-up, do not block the ventilation openings.
- Do not install the TV in a hot or humid place, or in a place subject to excessive dust or mechanical vibration.

CAUTION

When using TV games, computers, and similar products with your TV, keep the brightness and contrast functions at low settings. If a fixed (non-moving) pattern is left on the screen for long periods of time at a high brightness or contrast setting, the image can be permanently imprinted onto the screen. These types of imprints are not covered by your warranty because they are the result of misuse.

NOTIFICATION

This equipment has been tested and found to comply with the limits for a Class B digital device pursuant to Part 15 of the FCC Rules. These limits are designed to provide reasonable protection against harmful interference in a residential installation. This equipment generates, uses, and can radiate radio frequency energy and, if not installed and used in accordance with the instructions, may cause harmful interference with radio communications. However, there is no guarantee that interference will not occur in a particular installation. If this equipment does cause harmful interference to radio or television reception, which can be determined by turning the equipment off and on, the user is encouraged to try to correct the interference by one or more of the following measures:

- Reorient or relocate the receiving antennas.
- Increase the separation between the equipment and receiver.
- Connect the equipment into an outlet on a circuit different from that to which the receiver is connected.
- Consult the dealer or an experienced radio/TV technician for help.

You are cautioned that any changes or modifications not expressly approved in this manual could void your authority to operate this equipment.

This document is for the remote commander RM- Y135.
MODEL: KV-27S20/27V20/29PS1/29RS20/29RS20C/29SD1/
29V20M/32S20/34RS20C

Please keep this notice with the instruction manual.

Note on Caption Vision

This television receiver provides display of television closed captioning in accordance with § 15.119 of the FCC rules.

Note to CATV system installer

This reminder is provided to call the CATV system installer's attention to Article 820-40 of the NEC that provides guidelines for proper grounding and, in particular, specifies that the cable ground shall be connected to the grounding system of the building, as close to the point of cable entry as practical.

Use of this television receiver for other than private viewing of programs broadcast on UHF or VHF or transmitted by cable companies for the use of the general public may require authorization from the broadcaster, cable company and/or program owner.

Owner's Record

The model and serial numbers are located at the rear of the TV. Record these numbers in the spaces provided below. Refer to them whenever you call upon your Sony dealer regarding this product.

Model No. _____

Serial No. _____

Table of contents

- 4 Welcome!
- 4 Checking your model number

Getting Started

- 5 Step 1: Hookup
- 11 Step 2: Setting up the remote commander
- 12 Step 3: Setting up the TV automatically
(AUTO SET UP)
- 14 Changing the menu language

Operations

- 15 Watching the TV
- 17 Adjusting the picture (VIDEO)
- 18 Selecting the video mode (VIDEO)
- 18 Adjusting picture brightness automatically
(LIGHTSENSOR)
- 19 Adjusting the sound (AUDIO)
- 20 Using audio effect (EFFECT)
- 21 Selecting stereo or bilingual programs (MTS)
- 21 Setting the speaker switch (SPEAKER)
- 22 Setting audio out (AUDIO OUT)
- 22 Setting daylight saving time (DAYLIGHT SAVING)
- 23 Setting the clock (CURRENT TIME SET)
- 23 Setting the timer to turn the TV on and off (ON/OFF
TIMER)
- 24 Customizing the channel names (CHANNEL CAPTION)
- 25 Blocking out a channel (CHANNEL BLOCK)
- 26 Setting your favorite channels (FAVORITE CHANNEL)
- 27 Setting Caption Vision (CAPTION VISION)
- 28 Operating video equipment
- 29 Operating a cable box or DBS receiver

Additional Information

- 30 Troubleshooting
- 31 Specifications

Back cover Index

The captions in parentheses indicate menu names.

Welcome!

Thank you for purchasing the Sony Trinitron® Color TV. Here are some of the features you will enjoy with your TV:

- On-screen menus that let you set the picture quality, sound, and other settings.
- Surround system that simulates the sound quality of a concert hall or movie theater (*KV-27S20/29PS1/29RS20/29RS20C/29SD1/32S20/34RS20C only*).
- SRS (SOUND RETRIEVAL SYSTEM) that allows you to receive realistic sound that recaptures audio “clues” originally present but masked in the recording process so that the action seems to happen all around you (*KV-27V20/29V20M only*).
- LightSensor™ that automatically adjusts the brightness of the picture (*KV-27V20/29V20M only*).

Checking your model number

The instructions in this manual are for the nine models listed on the cover. Before you start reading, check your model number by looking at the rear of your TV. The KV-27S20 is the model used for illustration purposes. Any differences in operation are clearly indicated in the text, for example, “*KV-27S20 only*.”

Instructions in this manual are based on the remote commander. You can also use the controls on the TV if they have the same name as those on the remote commander.

Step 1: Hookup

Although you can use either an indoor or outdoor antenna with your TV, we recommend that you connect an outdoor antenna or a cable TV system to get better picture quality.

How to connect different types of cables

The illustrations below show examples of connecting cables to the TV directly.

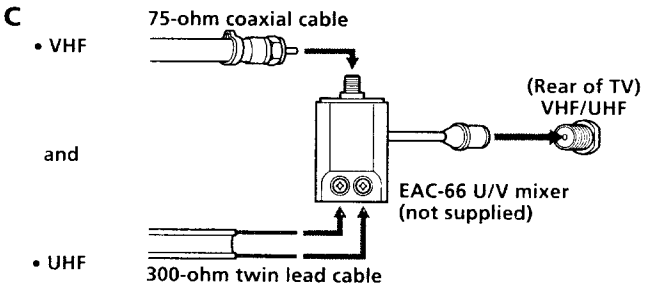
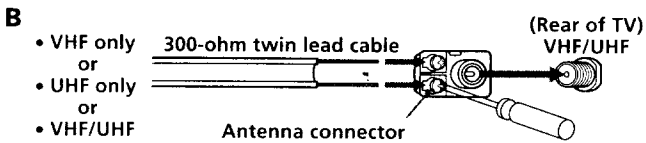
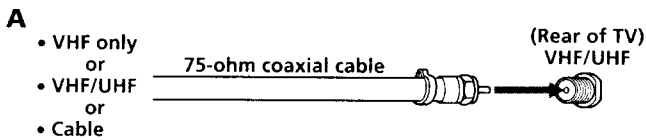

Notes

- Most VHF/UHF combination antennas have a signal splitter. Remove the splitter before attaching the appropriate connector.
- If you use the U/V mixer, snow and noise may appear in the picture when viewing cable TV channels over 37.

Connecting an antenna/cable TV system without a VCR

If your cable company requires you to connect a cable box, make the connection as follows:

Cable or antenna

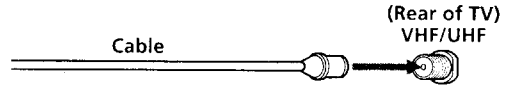

Cable box

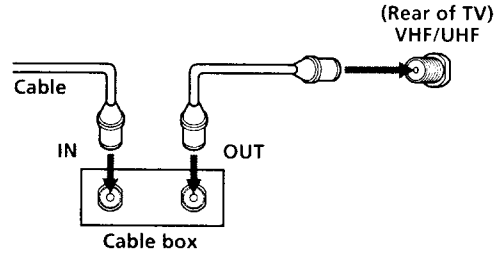

Connecting an antenna/cable TV system with a VCR

To connect your VCR to the TV, first check the model number of your TV and select the corresponding connection. For details on connection, see the instruction manual of your VCR.

Before making the connection, disconnect the AC power cords of the equipment to be connected.

Without a cable box

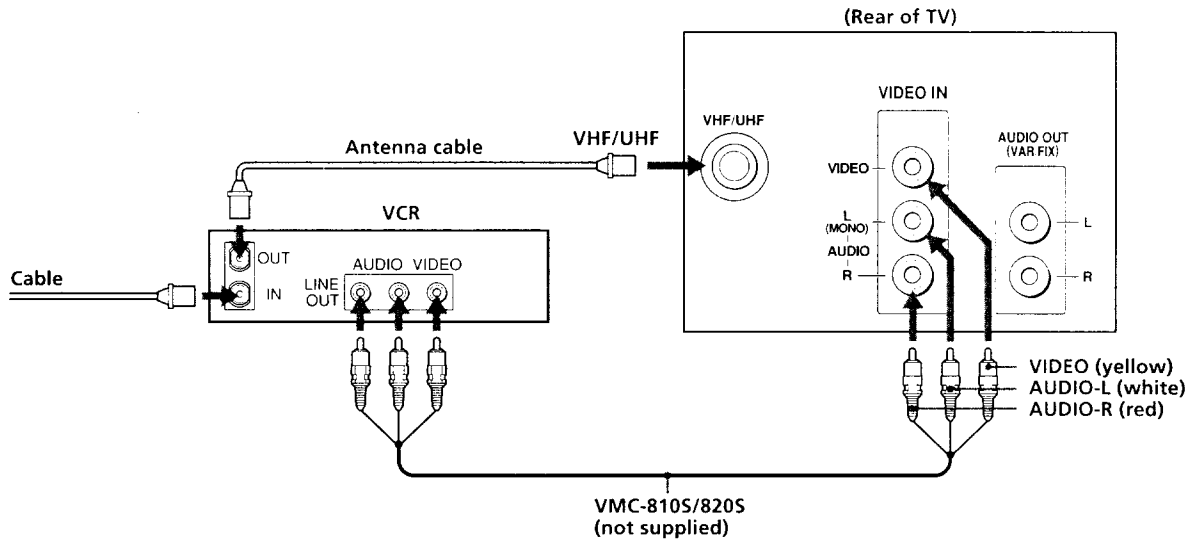

Note

- To connect a monaural VCR, connect the audio output of the VCR to AUDIO-L (mono) of VIDEO IN on the TV.

To an S video equipped VCR without a cable box

■ KV-27V20/29V20M only

If your VCR has an S video output jack, make the following connections.

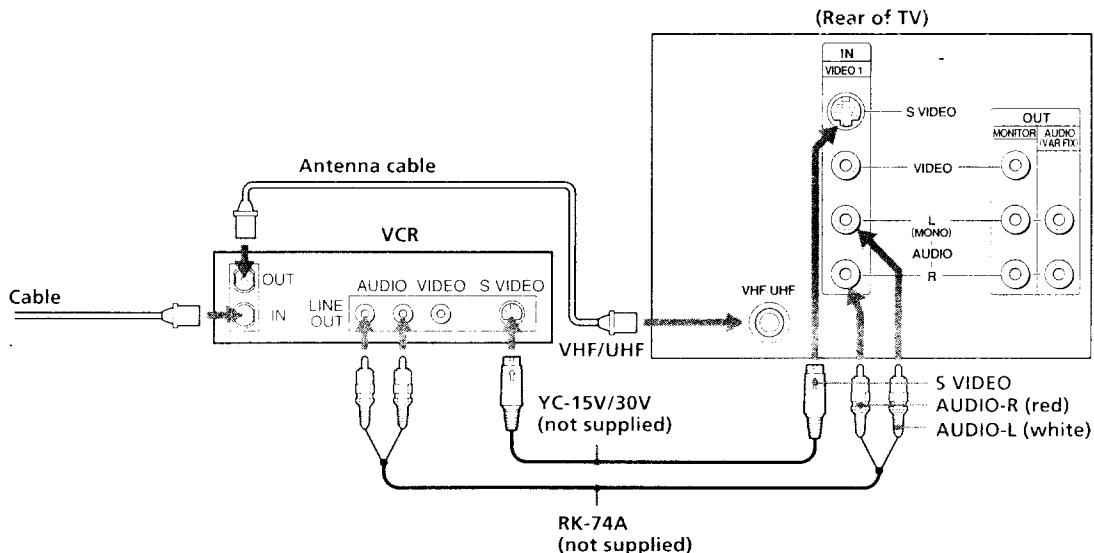

With a cable box

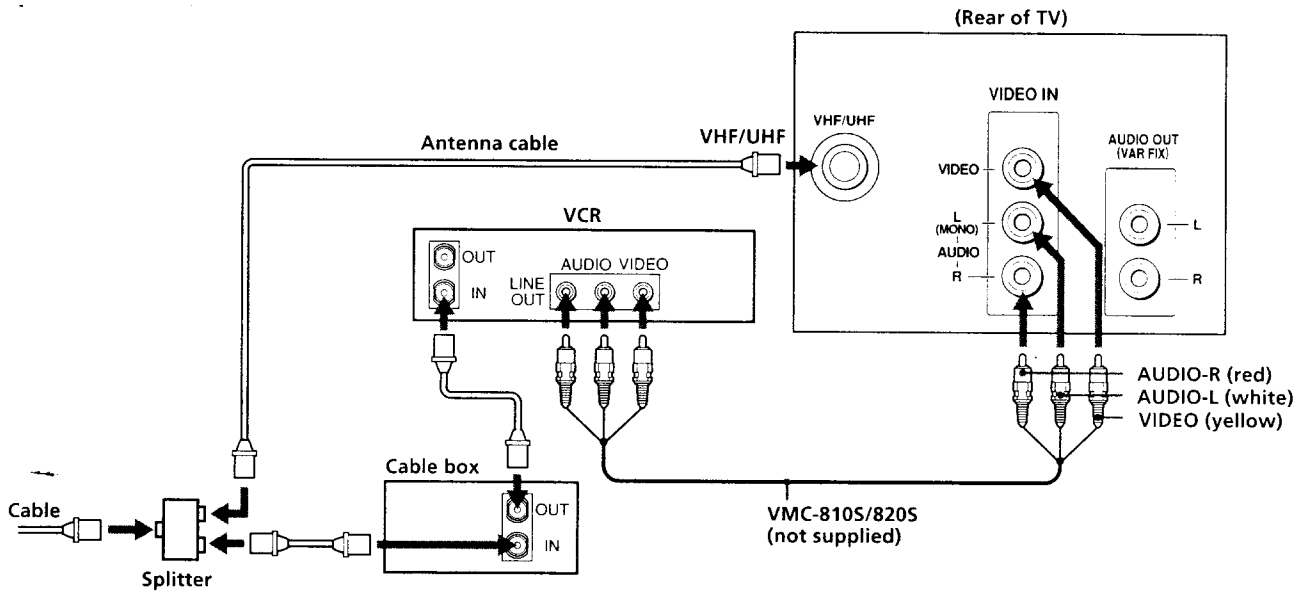

Note

- To connect a monaural VCR, connect the audio output of the VCR to AUDIO-L (mono) of VIDEO IN on the TV.

To an S video equipped VCR with a cable box

■ KV-27V20/29V20M only

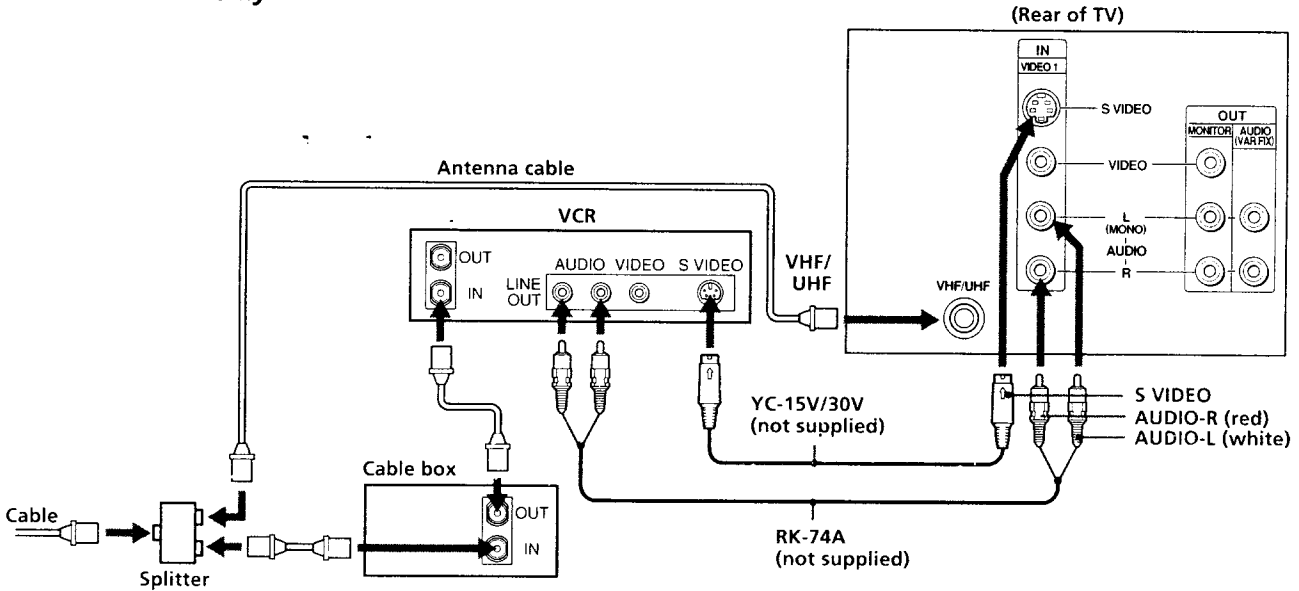

Note

- Video signals are composed of Y (luminance) and C (chroma) signals. The S connection sends the two signals separately preventing degradation, and gives better picture quality compared to conventional connections.

Connecting a DBS receiver

For connection details, see the instruction manual of the DBS (Digital Broadcasting Satellites) receiver.

To a TV

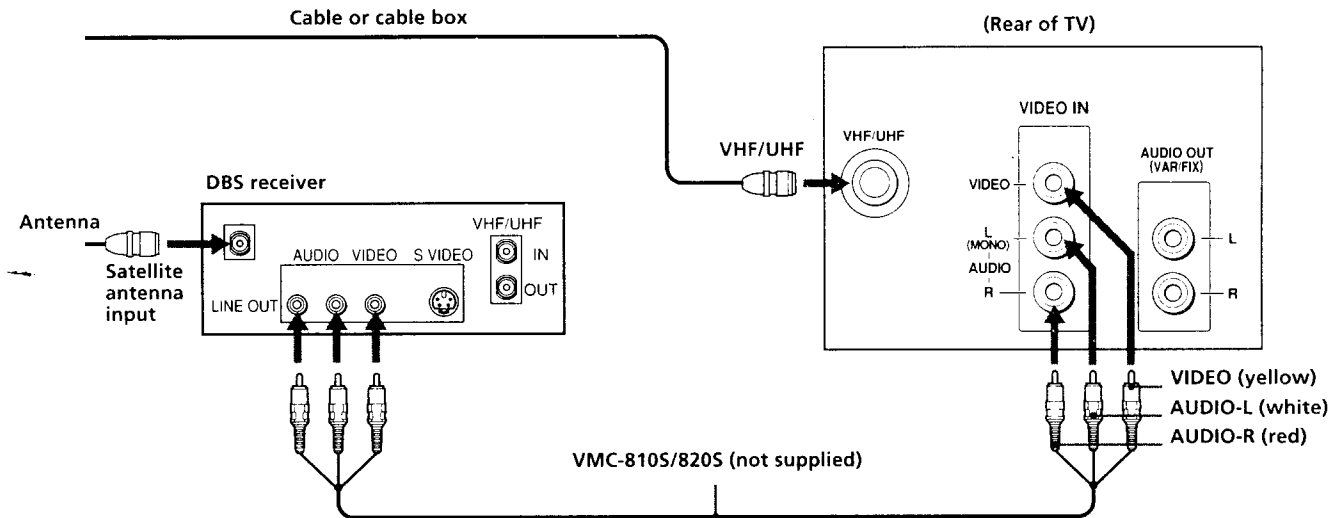

Note

- You can use the S VIDEO jack or the composite video jack for the video connection.

To a TV and VCR

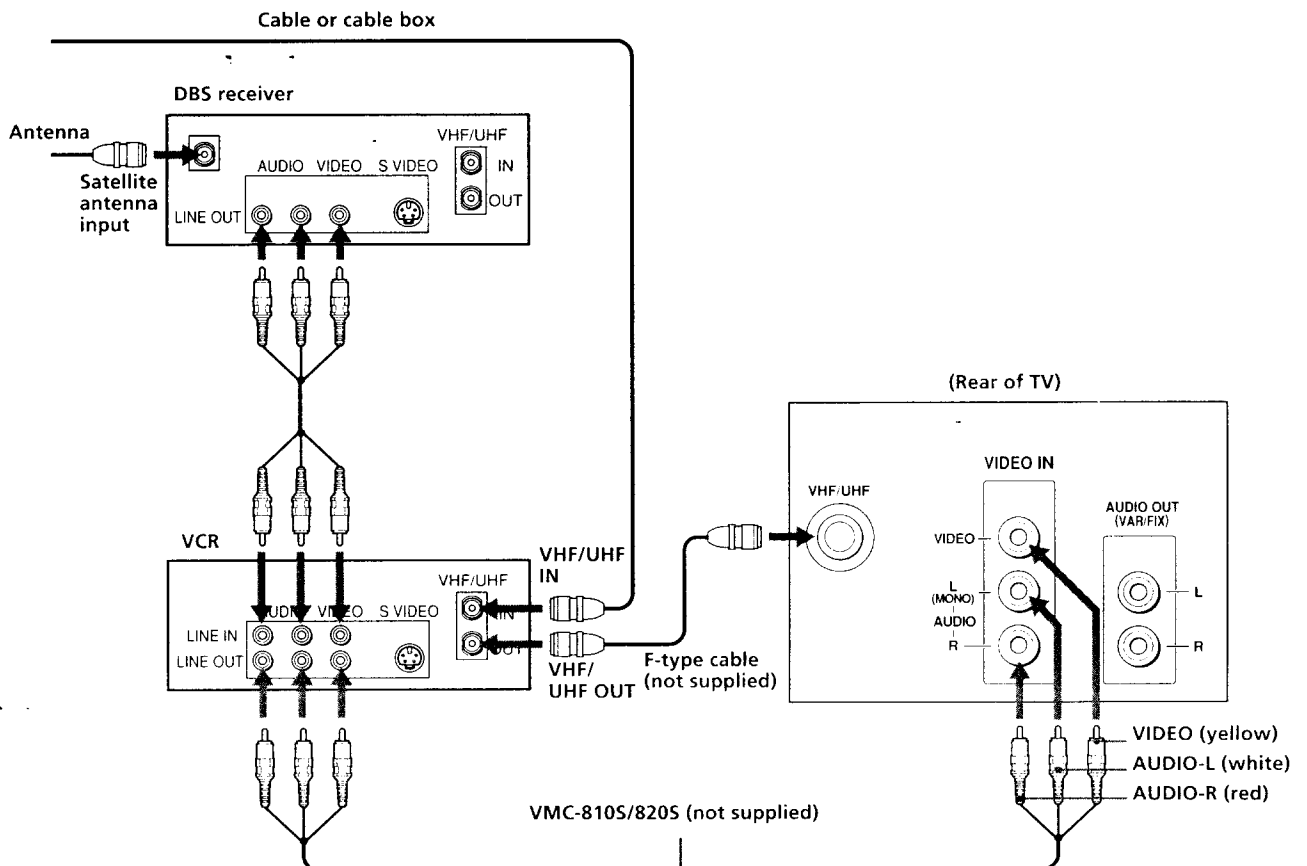

Connecting a camcorder

■ KV-27V20/29V20M only

This connection is convenient for viewing a camcorder picture.

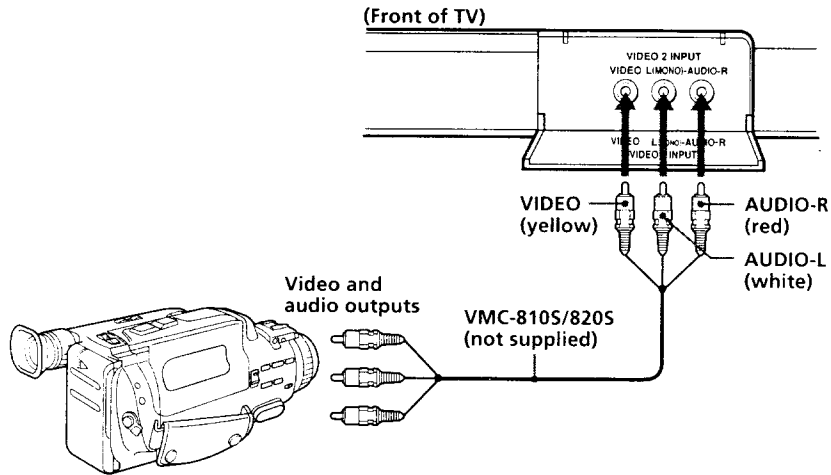

Note

- To connect a monaural camcorder, connect the audio output of the camcorder to AUDIO-L (mono) of VIDEO 2 INPUT on the TV.

Connecting an audio system

When connecting audio equipment, see pages 21-22 for more information.

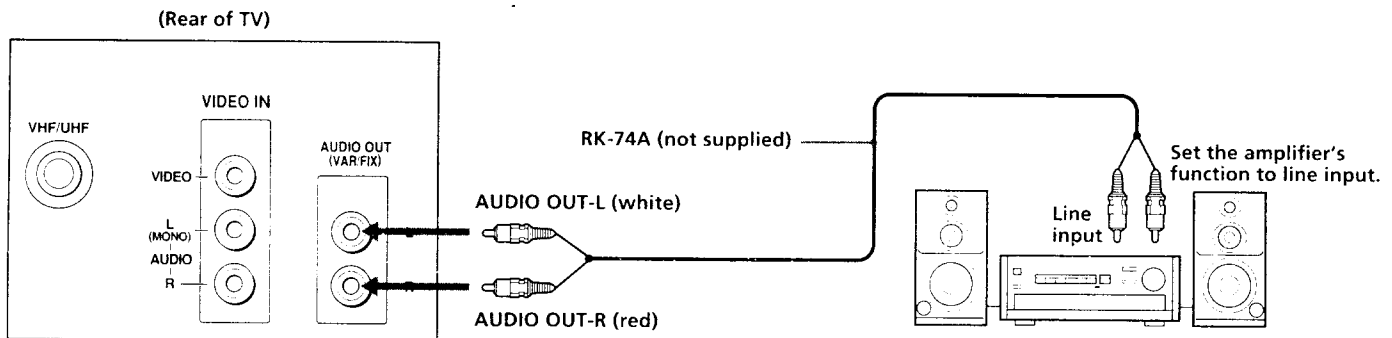

Connecting two VCRs for tape editing using MONITOR OUT

■ *KV-27V20/29V20M only*

MONITOR OUT allows you to record a program that is on the screen.

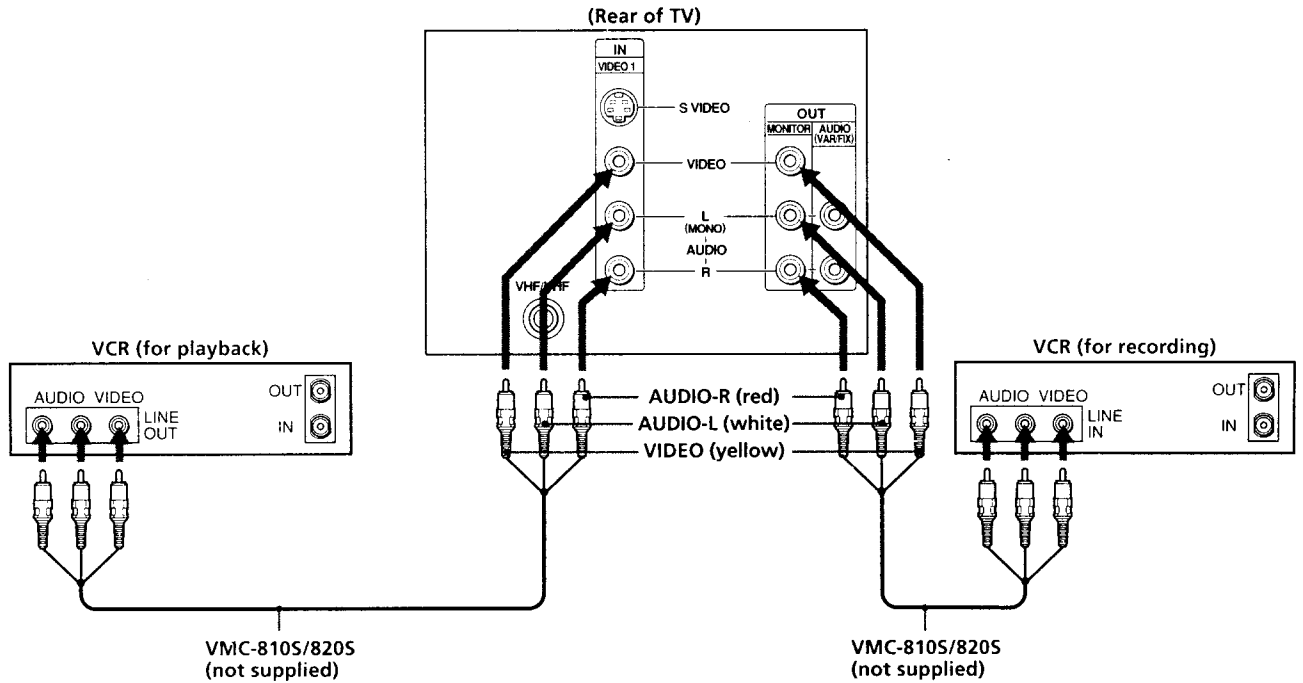

The above type of connection should only be used when you connect from the line input of one VCR, and from the line output of a second VCR.

Notes

- Do not change the input signal while editing through MONITOR OUT, or the output signal will also change.
- You can use the S video jack to connect a VCR for playback and the composite video jack to connect a VCR for recording.

- When connecting a single VCR to the TV, do not connect the MONITOR OUT jacks at the rear of the TV to the VCR's line input, while at the same time connecting from the TV's VIDEO IN jacks to the VCR's line output, as shown below.

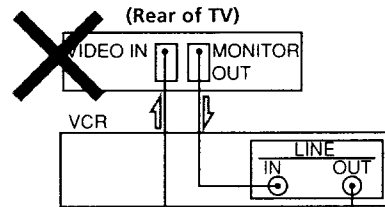

Step 2: Setting up the remote commander

Inserting batteries

Insert two size AA (R6) batteries (supplied) by matching the + and - on the battery to the diagram inside the battery compartment.

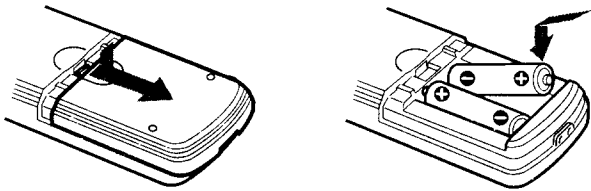

Notes

- Under normal conditions, batteries will last up to six months. If the remote commander does not operate properly or the indicators of the buttons on the remote commander do not light up, the batteries may be worn out. When replacing batteries, replace both of them with new ones.
- Do not mix old batteries with new ones or mix different types of batteries together.
- If the electrolyte inside the battery should leak, wipe the contaminated area of the battery compartment with a cloth and replace the old batteries with new ones. To prevent the electrolyte from leaking, remove the batteries when you don't plan to use the remote commander for a long period of time.
- Do not handle the remote commander roughly. Do not drop it, step on it or let it get wet.
- Do not place the remote commander in direct sunlight, near a heater, or where the humidity is high.

Getting to know buttons on the remote commander

Names of buttons on the remote commander are indicated in different colors to represent the available functions.

Button color

Transparent TV/VCR/DBS/Cable box function (light up) buttons. Press the appropriate function button first to change the remote commander's function.

Green Buttons relevant to power operations.

Label color

White TV/VCR/DBS/Cable box operation buttons.

Blue DBS operation buttons.

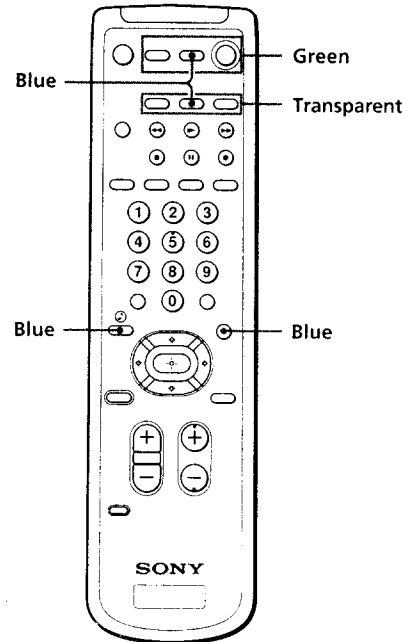

Step 3: Setting up the TV automatically

(AUTO SET UP)

You can set up your TV easily by using the AUTO SET UP feature. It presets all the receivable channels. To set up the TV manually, see "Setting cable TV on or off" (page 14) and "Presetting channels" (page 14).

(Front of TV)

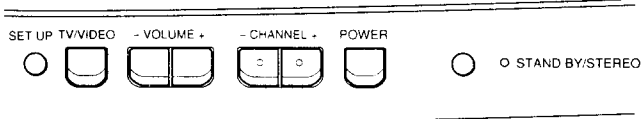

Before you start using AUTO SET UP, be sure to connect the antenna or cable to the TV (see page 5).

1 Press POWER to turn on the TV.

The AUTO SET UP screen appears.

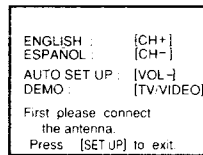

Note

- The AUTO SET UP screen appears whenever you press the POWER button if you do not execute AUTO PROGRAM.

2 (Except Canadian models)

Press CHANNEL + to select English screens or CHANNEL - to select Spanish screens.

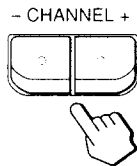

3 Press VOLUME -.

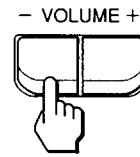

"AUTO PROGRAM" appears on the screen and the TV starts scanning and presetting channels automatically. When all the receivable channels are stored, "AUTO PROGRAM" disappears and the lowest numbered channel is displayed. If the TV receives cable TV channels, CABLE is set to ON automatically.

To perform AUTO SET UP again

- Press SET UP on the TV.
- (Except Canadian models) Press CHANNEL + or CHANNEL - to select the language.
- Press VOLUME -.
The picture and sound settings will be set to the factory preset conditions.
- Press CHANNEL +.
"AUTO PROGRAM" appears on the screen and the TV starts scanning and presetting channels.
- Press CHANNEL - to exit the AUTO SET UP menu.

To exit AUTO PROGRAM

Press any button.

Note

- If the TV is set to a video input, you cannot execute AUTO SET UP. Press TV (black button) so that a channel number appears.

To browse the main functions (DEMO)

Press TV/VIDEO on the TV in step 3. The functions and menus are displayed one by one.

To exit DEMO

Press any button.

Erasing or adding channels

After AUTO SET UP, you can erase unnecessary channels or add the channels you want. Preset channels during the day rather than late at night, when some channels may not be broadcasting.

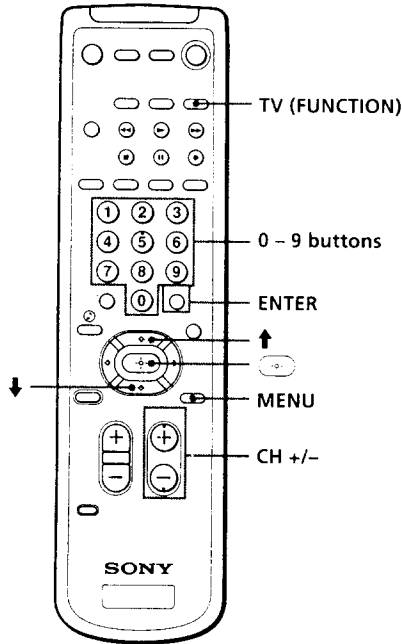

5 Erase and/or add channels:

To erase an unwanted channel

- (1) Make sure the cursor (▶) is beside ERASE.
- (2) Press CH +/- or the 0 - 9 buttons to select the channel you want to erase, and press ENTER.

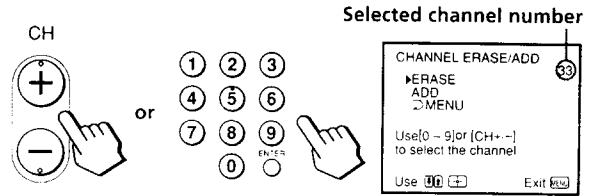

- (3) Press .

The “-” indication appears beside the channel number, showing that the channel is erased from the preset memory.

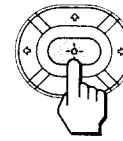

To add a channel that you want

- (1) Press or to move the cursor (▶) to ADD.
- (2) Press the 0 - 9 buttons to select the channel you want to add, and press ENTER.

1 Press TV (FUNCTION).

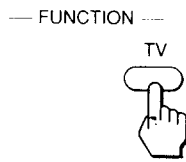

Selected channel number



- (3) Press .

The “+” indication appears beside the channel number, showing that the channel is added to the preset memory.

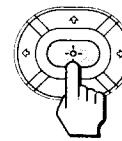

2 Press MENU.

The main menu appears.

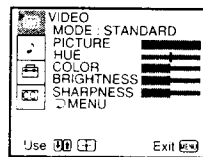

3 Press or to select , and press .

The SET UP menu appears.

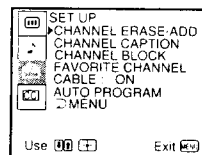
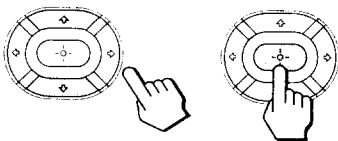

4 Press or to select CHANNEL ERASE/ADD, and press .

The CHANNEL ERASE/ADD menu appears.

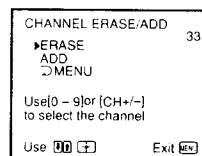
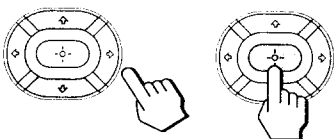

6 To erase and/or add other channels, repeat step 5.

7 Press MENU to return to the original screen.

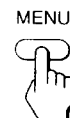





Note

- If you erase or add a VHF or UHF channel, the cable TV channel with the same number is also erased or added, and vice versa.

Setting cable TV on or off

If you have connected the TV to a cable TV system, set CABLE to ON (the factory setting). If not, set CABLE to OFF. You do not have to do this procedure if you execute AUTO SET UP (page 12). Do this procedure only when you want to set it manually.

- 1 Press **MENU**.
- 2 Press **↑** or **↓** to select , and press .
- 3 Set **CABLE** to ON or OFF:
 - (1) Press **↑** or **↓** to select CABLE, and press .
 - (2) Press **↑** or **↓** to select ON or OFF, and press .

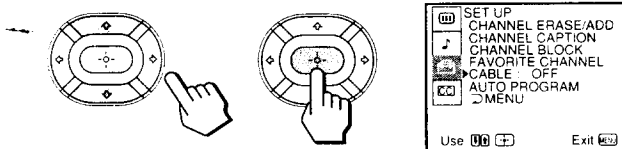



- 4 Press **MENU** to return to the original screen.

Note

- If CABLE appears in gray, the TV is set to a video input and you cannot select CABLE. Press TV (black button) so that a channel number appears.

Presetting channels

You can preset TV channels easily by using the AUTO PROGRAM feature. You do not have to do this procedure if you execute AUTO SET UP (page 12). Do this procedure only when you want to set it manually.

- 1 Press **MENU**.
- 2 Press **↑** or **↓** to select , and press .
- 3 Press **↑** or **↓** to select **AUTO PROGRAM**, and press .

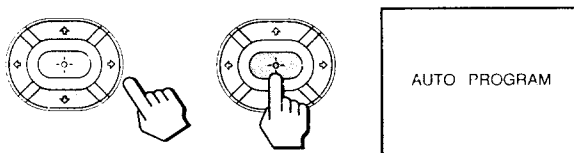

"AUTO PROGRAM" appears on the screen and the TV starts scanning and presetting channels automatically. When all the receivable channels are stored, "AUTO PROGRAM" disappears and the lowest numbered channel is displayed.

- 4 Press **MENU** to return to the original screen.

To exit AUTO PROGRAM

Press any button.



Note

- If the AUTO PROGRAM menu appears in gray, the TV is set to a video input and you cannot select AUTO PROGRAM. Press TV (black button) so that a channel number appears.

Changing the menu language

■ Except Canadian models

If you prefer Spanish to English, you can change the menu language. You do not have to do this procedure if you select the language during AUTO SET UP (page 12).

- 1 Press **MENU**.
- 2 Press **↑** or **↓** to select , and press .
- 3 Press **↑** or **↓** to select **LANGUAGE**, and press .

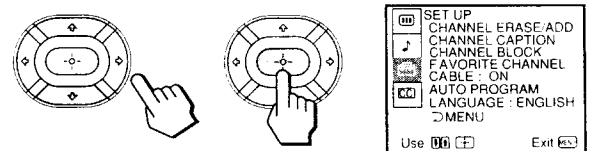

- 4 Press **↑** or **↓** to select your favorite language, "ENGLISH" or "ESPAÑOL," and press .

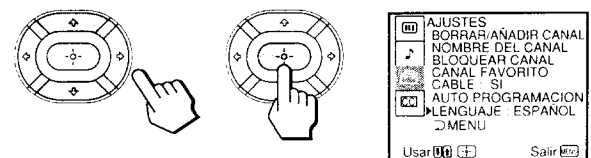

- 5 Press **MENU** to return to the original screen.

Note

- Certain parts of the Spanish menus remain in English.

Watching the TV

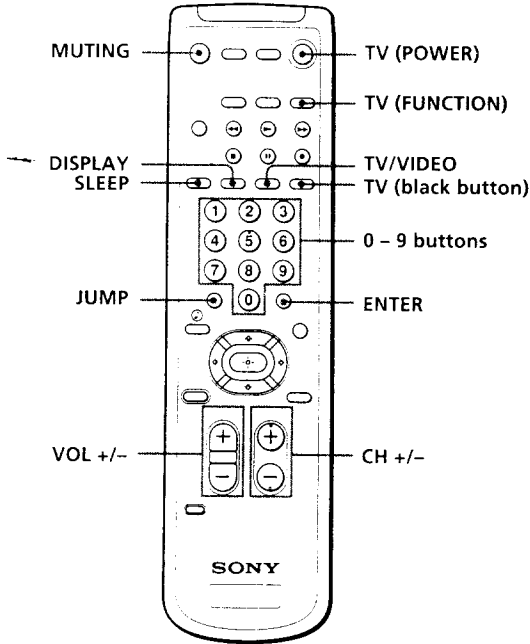

1 Press TV (POWER) to turn on the TV.



If "VIDEO" appears on the screen, press TV (black button) so that a channel number appears.

2 Press TV (FUNCTION).

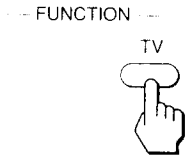

Once you press TV (FUNCTION), the TV function is set unless another function button is pressed.

3 Select the channel you want:

To select a channel directly

Press the 0-9 buttons, and press ENTER.

To scan through channels

Press CH +/- until the channel you want appears.

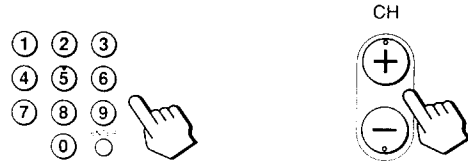

The channel can also be selected without pressing ENTER.

4 Press VOL +/- to adjust the volume.

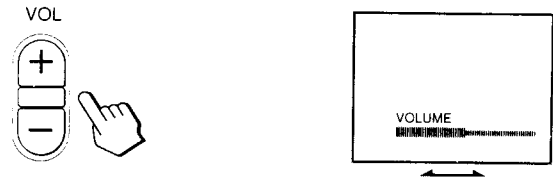

Switching quickly between two channels

You can use the JUMP button to switch or "jump" back and forth between two channels.

Press JUMP.



Pressing JUMP again switches back the channel.

Note

- You cannot jump to channels you scanned through using the CH +/- buttons.

Muting the sound

Press MUTING.

"MUTING" appears on the screen.



To restore the sound, press MUTING again, or press VOL +.

Displaying on-screen information

Press DISPLAY repeatedly until the desired display appears.

Each time you press DISPLAY, the display changes as follows:

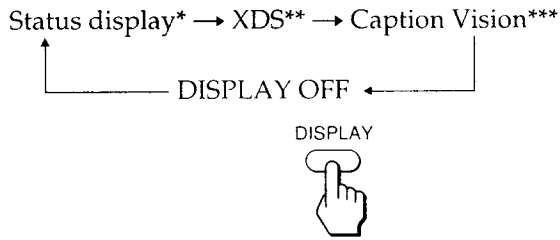

* Channel number, the current time (only for available models), channel caption (if set), and MTS mode (if SAP is selected) are displayed. SAP indication disappears after three seconds.

** Some programs are broadcast with XDS (Extended Data Service) which shows a network name, program name, program type, program length, call letters, and time of the show. When you select XDS with the DISPLAY button, this information will be displayed on the screen if the broadcaster offers this service.

*** Some programs are broadcast with Caption Vision. When you select Caption Vision with the DISPLAY button, Caption Vision will be displayed on the screen if the broadcaster offers this service. (See page 27 for selecting Caption Vision.)

To cancel the display, press DISPLAY repeatedly until "DISPLAY OFF" appears. "DISPLAY OFF" goes off after three seconds.

Setting the Sleep Timer

The TV stays on for the length of time you specify and then shuts off automatically.

Press SLEEP repeatedly until the time (minutes) you want appears.

Each time you press SLEEP, the time changes as follows:

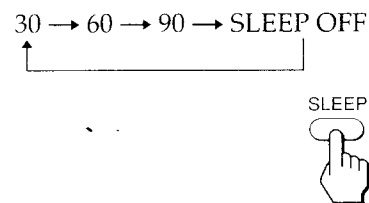

To cancel the Sleep Timer, press SLEEP repeatedly until "SLEEP OFF" appears, or turn the TV off.

Watching a video input picture

Press TV/VIDEO repeatedly until the desired video input appears.

Each time you press TV/VIDEO, the display changes as follows:

■ **KV-27S20/29PS1/29RS20/29RS20C/29SD1/32S20/34RS20C only**

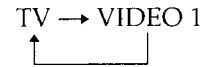

■ **KV-27V20/29V20M only**

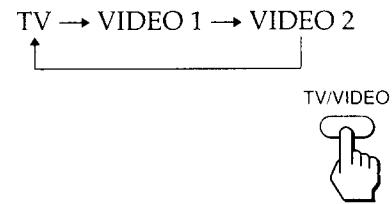

To return to the TV picture, press TV (black button) so that a channel number appears.

Adjusting the picture (VIDEO)

When watching TV programs, you can adjust the picture to suit your taste. You can adjust the picture of video input(s) as well.

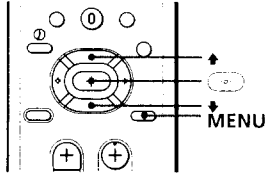

1 Press MENU.

2 Press ↑ or ↓ to select , and press .

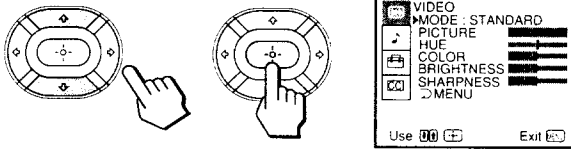

3 Select the item you want to adjust.
For example:

(1) To adjust the brightness, press ↑ or ↓ to move the cursor (▶) to BRIGHTNESS.





(2) Press .

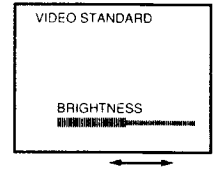
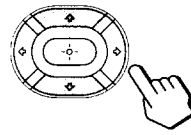

4 Adjust the selected item:

(1) Press ↑ or ↓ to adjust the item.



(2) Press .

The new setting appears in the VIDEO menu.

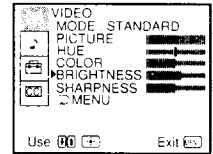
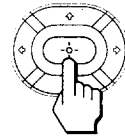

For details on each item, see “Description of adjustable items” below.

5 To adjust other items, repeat steps 3 and 4.

6 Press MENU to return to the original screen.

Description of adjustable items

Item	Press ↓ to	Press ↑ to
PICTURE	Decrease picture contrast and give soft color.	Increase picture contrast and give vivid color.
HUE	Make picture tones become purplish.	Make picture tones become greenish.
COLOR	Decrease color intensity.	Increase color intensity.
BRIGHTNESS	Darken the picture.	Brighten the picture.
SHARPNESS	Soften the picture.	Sharpen the picture.

To restore the factory settings

Press RESET while the VIDEO menu is displayed. All the settings are restored to the factory settings.

Selecting the video mode (VIDEO)

The video mode feature allows you to choose three different modes of picture settings. Choose the one that best suits the type of program that you want to watch.

- 1 Press **MENU**.
- 2 Press **↑** or **↓** to select **VIDEO**, and press **ENTER**.
- 3 Press **↑** or **↓** to select **MODE**, and press **ENTER**.
- 4 Press **↑** or **↓** to select **STANDARD**, **MOVIE**, or **SPORTS** mode, and press **ENTER**.

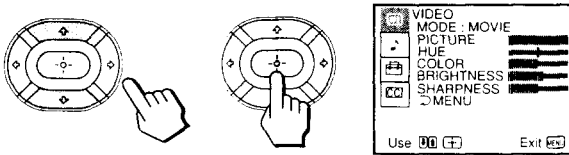

Choose	To
STANDARD	Receive a standard picture.
MOVIE	Receive a finely detailed picture.
SPORTS	Receive a vivid, bright picture.

- 5 Press **MENU** to return to the original screen.

Note

- The settings for these modes can be adjusted in the VIDEO menu.

Adjusting picture brightness automatically (LIGHTSENSOR)

■ KV-27V20I/29V20M only

The LightSensor feature adjusts the brightness of the picture automatically according to the ambient brightness.

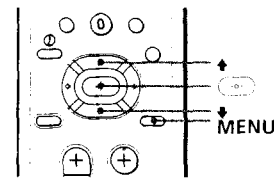

- 1 Press **MENU**.
- 2 Press **↑** or **↓** to select **VIDEO**, and press **ENTER**.
- 3 Press **↑** or **↓** to select **LIGHTSENSOR**, and press **ENTER**.

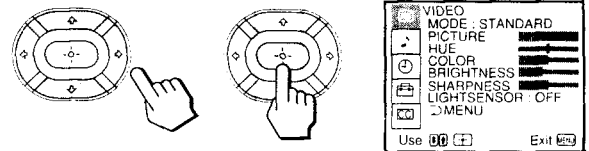

- 4 Press **↑** or **↓** to select **ON** or **OFF**, and press **ENTER**.

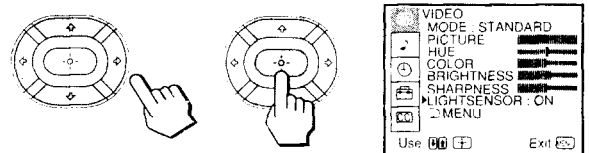

- 5 Press **MENU** to return to the original screen.

Note

- The LightSensor function may malfunction if you stand or place objects in front of the TV.

Adjusting the sound (AUDIO)

You can adjust the TV sound to suit your taste. You can adjust the sound of the video input(s) as well.

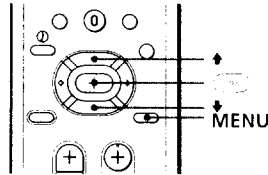

1 Press MENU.

2 Press ↑ or ↓ to select , and press .

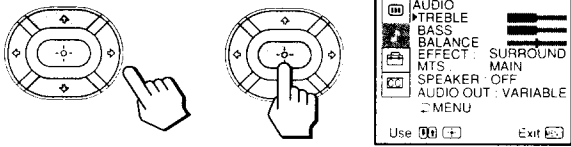

3 Select the item you want to adjust.

For example:

(1) To adjust bass, press ↑ or ↓ to move the cursor (▶) to BASS.





(2) Press .

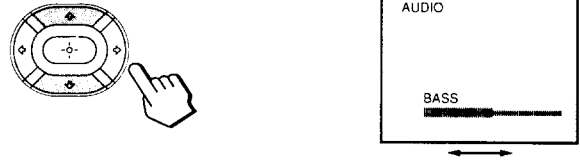

4 Adjust the selected item:

(1) Press ↑ or ↓ to adjust the item.



(2) Press .

The new setting appears in the AUDIO menu.



For details on each item, see “Description of adjustable items” below.

5 To adjust other items, repeat steps 3 and 4.

6 Press MENU to return to the original screen.

Description of adjustable items

Item	Press ↓ to	Press ↑ to
TREBLE	Decrease the treble response.	Increase the treble response.
BASS	Decrease the bass response.	Increase the bass response.
BALANCE	Emphasize the left speaker's volume.	Emphasize the right speaker's volume.

To restore the factory settings

Press RESET while the AUDIO menu is displayed.

Note

- When SPEAKER (page 21) is OFF and AUDIO OUT (page 22) is in the FIXED condition, the volume, TREBLE, BASS, and BALANCE cannot be adjusted.

Using audio effect (EFFECT)

Using the (audio effect) button

■ For KV-27S20/29PS1/29RS20/29RS20C/29SD1/32S20/34RS20C only

Press .

Each time you press the  button, the display changes as follows:

SURROUND → SURROUND OFF

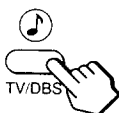



■ For KV-27V20/29V20M only

Press .

Each time you press the  button, the display changes as follows:

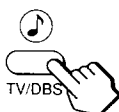
SRS → SIMULATED → EFFECT OFF





Choose	To
SURROUND	Simulate sound reproduction with the atmosphere of a movie theater or a concert hall. Surround sound is only effective for stereo programs.
SRS	When the program's audio signal is stereo or encoded, SRS expands the material and embraces you with dynamic three-dimensional sound.
SIMULATED	Receive monaural sound with a surround-like effect.

Note

- To use the  button function, press TV (FUNCTION).

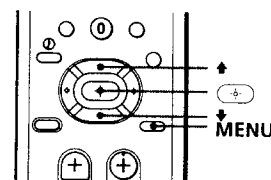
Using the menu to set audio effect



1 Press MENU.

2 Press ↑ or ↓ to select , and press .

3 Press ↑ or ↓ to select EFFECT, and press .

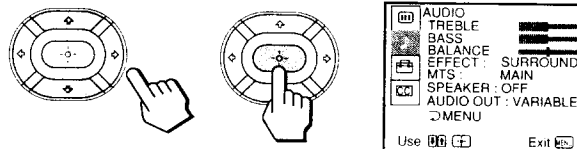

4 Press ↑ or ↓ to select the audio effect mode, and press .

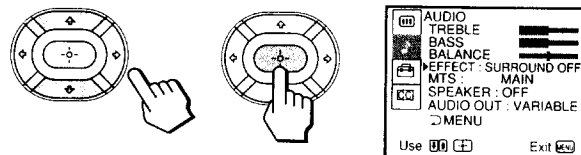

5 Press MENU to return to the original screen.

Selecting stereo or bilingual programs (MTS)

The Multichannel TV Sound (MTS) feature allows you to enjoy stereo sound or Second Audio Programs (SAP) of your choice. The initial setting is stereo sound (MAIN).

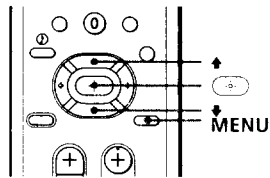

- 1 Press **MENU**.
- 2 Press **↑** or **↓** to select **♪**, and press **↔**.
- 3 Press **↑** or **↓** to select **MTS**, and press **↔**.

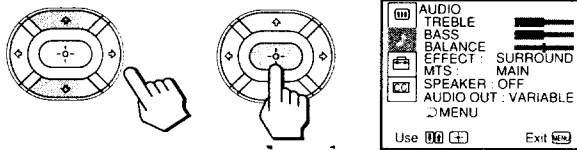

- 4 Press **↑** or **↓** to select **MAIN**, **SAP**, or **MONO**, and press **↔**.

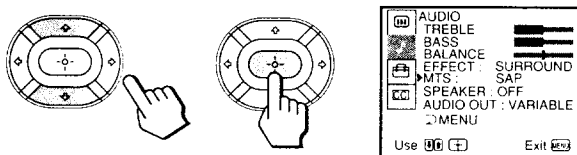

Choose	To
MAIN	Listen to stereo sound. The STEREO indicator on the TV lights up when a stereo broadcast is received.
SAP	Listen to bilingual programs. There is no sound when the SAP signal is not broadcasting.
MONO	Listen to monaural sound. Reduce noise during stereo broadcasts.

- 5 Press **MENU** to return to the original screen.

Note

- Stereo and SAP sounds are subject to program sources.

Setting the speaker switch (SPEAKER)

You may switch off the TV speakers when, for example, you want to listen to the sound through a stereo system.

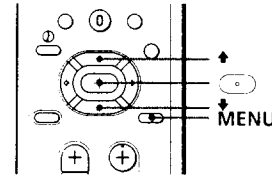

- 1 Press **MENU**.
- 2 Press **↑** or **↓** to select **♪**, and press **↔**.
- 3 Press **↑** or **↓** to select **SPEAKER**, and press **↔**.

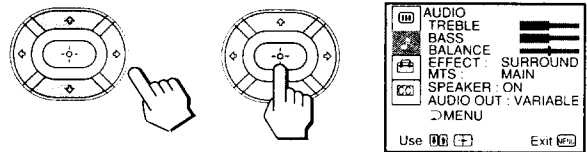

- 4 Press **↑** or **↓** to select **ON** or **OFF**, and press **↔**.

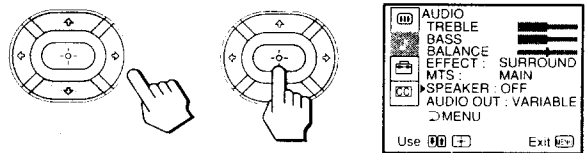



- 5 Press **MENU** to return to the original screen.

Setting audio out (AUDIO OUT)

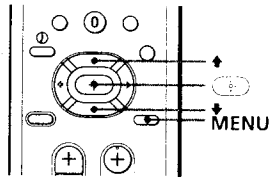
You can change AUDIO OUT to VARIABLE or FIXED when SPEAKER is set to OFF.
AUDIO OUT is variable when SPEAKER is set to ON.



- 1 Press MENU.
- 2 Press ↑ or ↓ to select , and press .
- 3 Press ↑ or ↓ to select AUDIO OUT, and press .

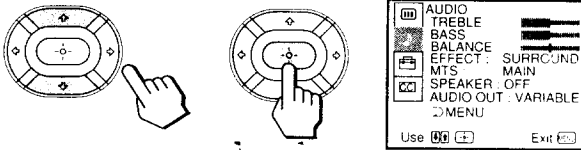

- 4 Press ↑ or ↓ to select VARIABLE or FIXED, and press .

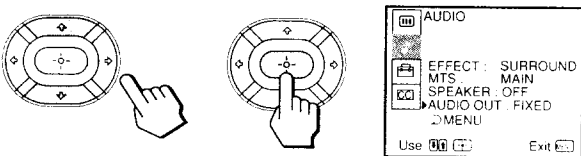

VARIABLE: Sound output varied according to the TV settings. You can adjust the volume, bass, treble, and balance.

FIXED: Sound output is always fixed to a certain level. The volume, bass, treble, and balance are also fixed to the factory settings.

- 5 Press MENU to return to the original screen.



Note

- If AUDIO OUT appears in gray, set SPEAKER to OFF.

Setting daylight saving time (DAYLIGHT SAVING)

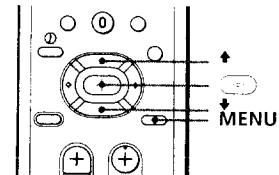
■ KV-27V20/29V20M only



- 1 Press MENU.
- 2 Press ↑ or ↓ to select , and press .
- 3 Press ↑ or ↓ to select DAYLIGHT SAVING, and press .

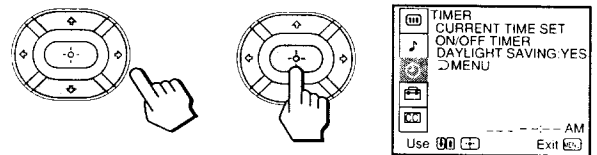

- 4 Press ↑ or ↓ to select YES or NO, and press .

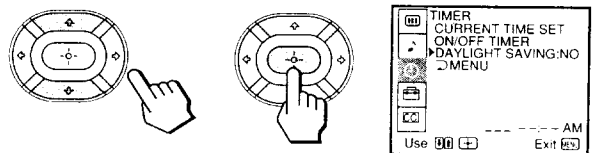

Choose To

YES	Set for daylight saving start. The current time automatically moves one hour ahead.
NO	Set for daylight saving end.

- 5 Press MENU to return to the original screen.

Setting the clock (CURRENT TIME SET)

■ KV-27V20I29V20M only

Setting the clock enables you to turn the TV on and off with the timer. Make sure to set daylight saving time first.

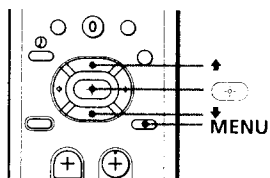

- 1 Press MENU.
- 2 Press ↑ or ↓ to select ⊕, and press ⊞.
- 3 Press ↑ or ↓ to select CURRENT TIME SET, and press ⊞.

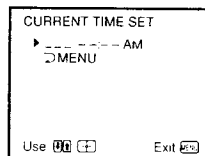
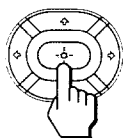

- 4 Make sure the cursor (▶) is to the left of "--:-- AM," and press ⊞.

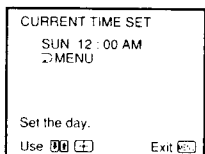
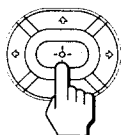

- 5 Set the current time.

(1) Press ↑ or ↓ to set the day, and press ⊞.

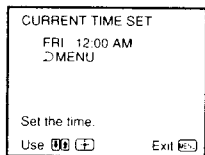
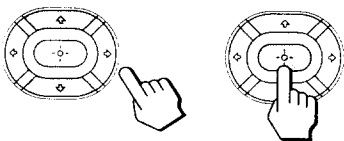

(2) Set the hour and minutes in the same way as in step (1). When you press ⊞ after setting the minutes, the clock starts.

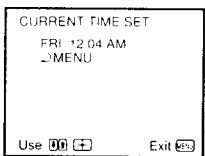
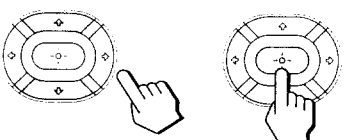

- 6 Press MENU to return to the original screen.

Setting the timer to turn the TV on and off (ON/OFF TIMER)

■ KV-27V20I29V20M only

You can set the TV to turn on and off at the times you specify. Make sure the clock is set correctly. If it is not, set the clock first.

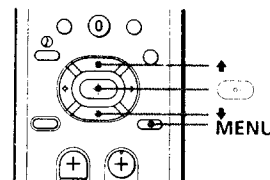

- 1 Press MENU.
- 2 Press ↑ or ↓ to select ⊕, and press ⊞.
- 3 Press ↑ or ↓ to select ON/OFF TIMER, and press ⊞.

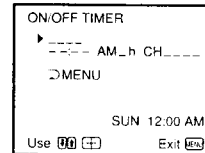
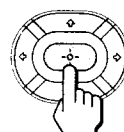
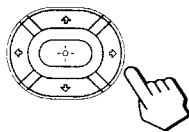

- 4 Press ⊞ and enter the ON/OFF TIMER setting.

(1) Press ↑ or ↓ to set the day(s), and press ⊞.

Each time you press ↑ or ↓, the days cycle as follows:

EVERY SUN-SAT → EVERY MON-FRI → SUNDAY → ... → SATURDAY → EVERY SUNDAY → ... → EVERY SATURDAY

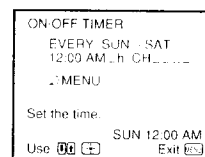
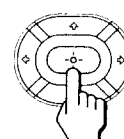
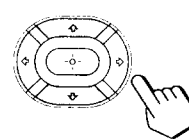
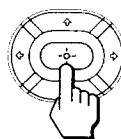

(continued)

- (2) Press **▲** or **▼** to set the time (hour then minutes) that you want to turn on the TV, and press **○**.

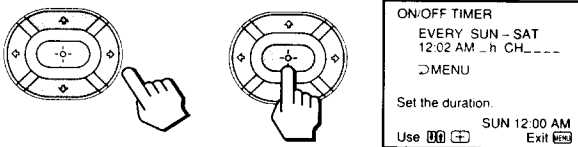

- (3) Press **▲** or **▼** to set the time duration, and press **○**.

Each time you press **▲**, the time duration increases by one hour up to a maximum of six hours.

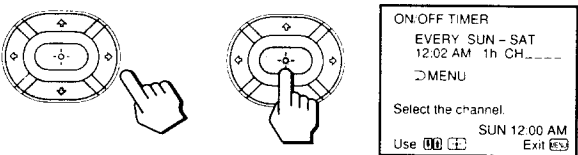

- (4) Press **▲** or **▼** to select the channel, and press **○**.

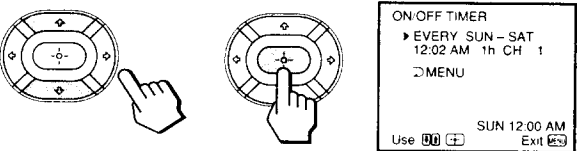

The **TIMER** indicator on the TV lights up.

5 Press **MENU** to return to the original screen.

One minute before the TV turns off, the message "TV will be off soon." is displayed on the screen.

To cancel the timer

In step 3 or 4, press **RESET**.

Note

- If you unplug the TV or a power interruption occurs, the **ON/OFF TIMER** setting will be erased. Reset the current time, then set the timer.

Customizing the channel names (CHANNEL CAPTION)

You can add a caption for up to 12 channels. This feature allows you to easily identify which channel you are watching. You can make your own caption.

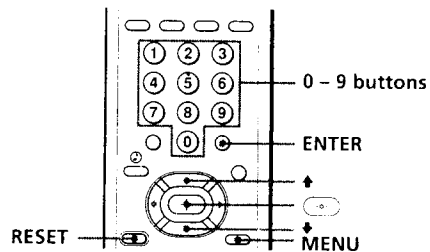

- 1** Press **MENU**.

- 2** Press **▲** or **▼** to select **□**, and press **○**.

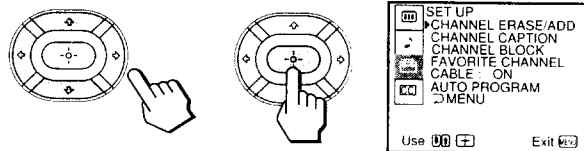

- 3** Press **▲** or **▼** to select **CHANNEL CAPTION**, and press **○**.

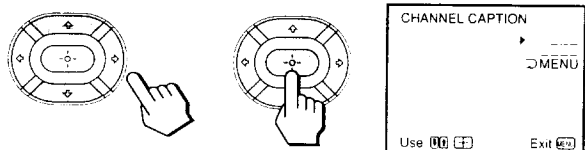

- 4** Press **○** and press **▲** or **▼** to select the channel that you want to caption, and press **○**.

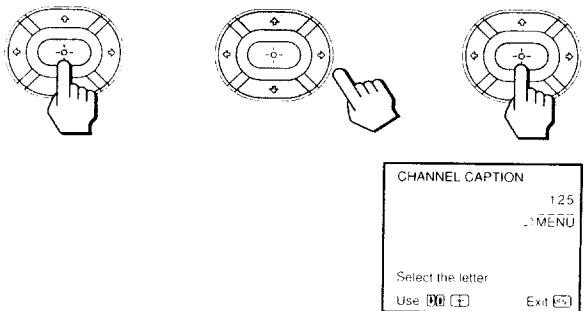

5 Enter the letters (up to four) to caption the channel:

(1) Press \uparrow or \downarrow to select the first letter.

Each time you press \uparrow or \downarrow , the letter changes as follows:

0 \leftrightarrow 1 \leftrightarrow ... \leftrightarrow 9 \leftrightarrow A \leftrightarrow B \leftrightarrow ... \leftrightarrow Z \leftrightarrow & \leftrightarrow / \leftrightarrow (blank space)

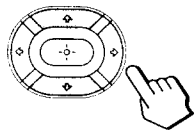

(2) Press \ominus .

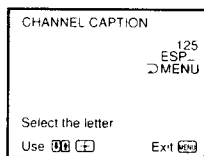
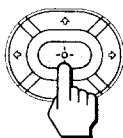

(3) Repeat steps (1) and (2) to select the remaining letters, and press \ominus .

6 To caption other channels, repeat steps 4 and 5.

7 Press MENU to return to the original screen.

After you customize the channel, the channel caption appears green.

To erase a caption

In step 5, press RESET.

Notes

- If the CHANNEL CAPTION menu appears in gray, the TV is set to a video input, and you cannot select CHANNEL CAPTION. Press TV (black button) so that a channel number appears.
- If more than 90 seconds elapse after you press a button, the menu disappears automatically.

Blocking out a channel (CHANNEL BLOCK)

The channel block feature allows you to prevent children from watching unsuitable programs. You can block out two channels.

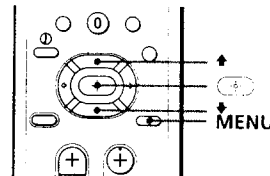

1 Press MENU.

2 Press \uparrow or \downarrow to select CH-- , and press \ominus .

3 Press \uparrow or \downarrow to select CHANNEL BLOCK, and press \ominus .

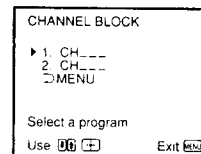
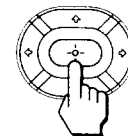
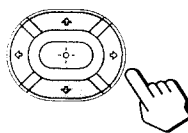

4 Press \uparrow or \downarrow to select 1 or 2, and press \ominus .

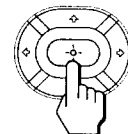
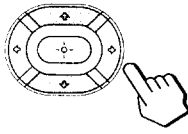

5 Press \uparrow or \downarrow to select the channel which you want to block out, and press \ominus .

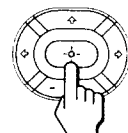
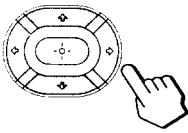

6 Press MENU to return to the original screen.

When you select the blocked channel "BLOCKED" appears on the screen.

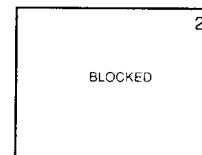

To cancel a CHANNEL BLOCK setting

In step 4 or 5, press RESET.

Note



- Once you use CHANNEL BLOCK, Caption Vision and XDS of the blocked channel and the selected channel output from TV OUT/MONITOR OUT are also blocked out.

Setting your favorite channels (FAVORITE CHANNEL)

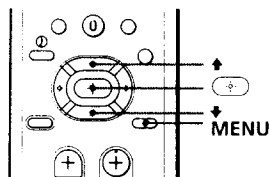

The favorite channel feature allows your TV to memorize your favorite channels easily. If you set to AUTO, the last five channels you selected with the 0–9 buttons are automatically set as your favorite channels. If you want to input your own selection of channels, set to MANUAL.

Setting your favorite channels

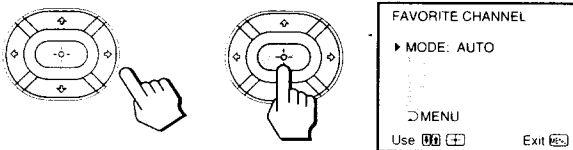

- 1 Press **MENU**.
- 2 Press **↑** or **↓** to select , and press .
- 3 Press **↑** or **↓** to select **FAVORITE CHANNEL**, and press .



- 4 Press  and press **↑** or **↓** to select **AUTO** or **MANUAL**, and press .

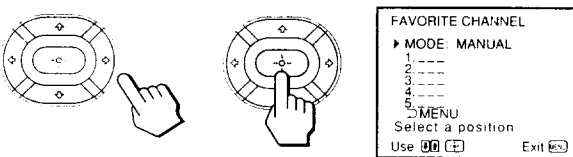

If you select AUTO, skip steps 5 and 6. The last five channels you selected with the 0–9 buttons are automatically set as your favorite channels.

If you select MANUAL, the favorite channel numbers become white, indicating that favorite channels can be entered.

- 5 Press **↑** or **↓** to select a favorite channel number, and press .

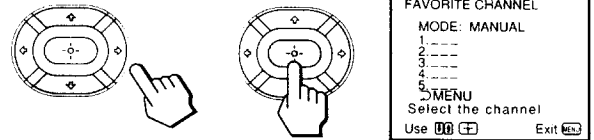

- 6 Press **↑** or **↓** to select the channel that you want to set as your favorite channel, and press .

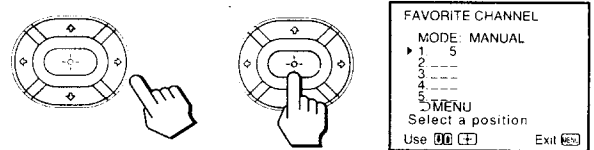

- 7 Press **MENU** to return to the original screen.

Notes

- If the FAVORITE CHANNEL menu appears in gray, the TV is set to a video input and you cannot select FAVORITE CHANNEL.
- If more than 90 seconds elapse after you press another button, the menu disappears automatically.

Selecting your favorite channel

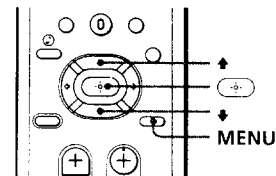

- 1 Press . The FAVORITE CHANNEL menu appears.



- 2 Press **↑** or **↓** to select the favorite channel you want to watch, and press . The selected channel appears on the screen.

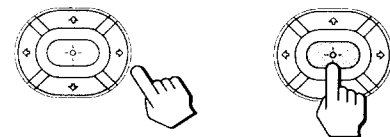

To cancel the FAVORITE CHANNEL menu

Press **↑** or **↓** to select "Exit," and press .

Setting Caption Vision (CAPTION VISION)

Some programs are broadcast with Caption Vision. To display Caption Vision, select either CC1, CC2, CC3, CC4, TEXT1, TEXT2, TEXT3, or TEXT4 from the menu. CC1, CC2, CC3, or CC4 shows you a caption, that is a printed version of the dialogue or sound effects of a program. (The mode should be set to CC1 for most programs.) TEXT1, TEXT2, TEXT3, or TEXT4 shows you text, that is information presented using either half or the whole screen. It is not usually related to the program.

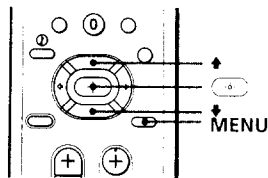

1 Press MENU.

2 Press ↑ or ↓ to select CC, and press ○.

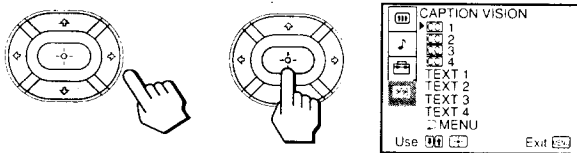

3 Press ↑ or ↓ to select the caption type, and press ○.

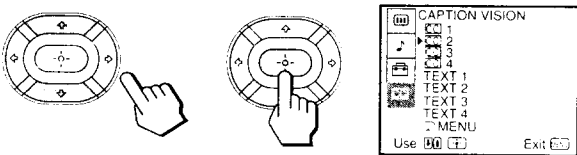

4 Press MENU to return to the original screen.

To display Caption Vision

Press DISPLAY. (See page 16 for details.)

Notes

- Poor reception of TV programs can cause errors in Caption Vision and XDS. Captions may appear with a white box or other errors instead of a certain word.
- XDS, Caption Vision, and the status display cannot be used at the same time.
- For details on XDS, see page 16.

Operating video equipment

You can use the supplied remote commander to operate Sony or non-Sony video equipment that has an infrared remote sensor. For this operation, set the manufacturer's code number.

Setting the manufacturer's code

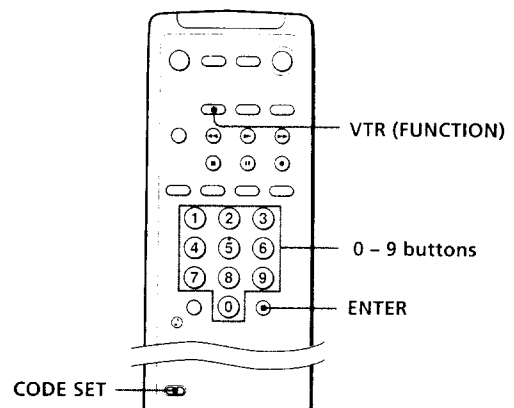

Press the **CODE SET**, **VTR (FUNCTION)**, and **0 - 9** buttons to enter the manufacturer's code number (see the chart in the following page), then press **ENTER**. For example, to operate a Sony 8 mm VCR, press **CODE SET**, **VTR (FUNCTION)**, **3**, **0**, **2**, and **ENTER**.

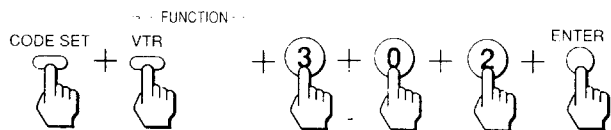

(continued)

VCR manufacturer code numbers

Manufacturer	Code number
Sony	301, 302, 303
Aiwa	338
Admiral (M. Wards)	327
Audio Dynamic	314, 337
Bell & Howell (M. Wards)	330, 343
Broksonic	319, 317
Canon	309, 308
Citizen	332
Craig	315, 302, 332
Curtis Mathis	304, 338, 309
Daewoo	341, 312, 309
DBX	314, 336, 337
Dimensia	304
Emerson	319, 320, 316, 317, 318, 341
Fisher	330, 334, 335, 333
Funai	338
General Electric	329, 304, 309
Go Video	322
Goldstar	332
Hitachi	306, 304, 305
Instant Replay	309, 308
JC Penney	309, 305, 304, 330, 314, 336, 337
JVC	314, 336, 337
Kenwood	314, 336, 332, 337
LXI (Sears)	332, 305, 333, 334, 330, 335, 338
Magnavox	308, 309, 310
Marantz	314, 336, 337
Marta	332
Memorex	309, 335
Minolta	305, 304
Mitsubishi/MGA	323, 324, 325, 326
Multitech	325, 338, 321
NEC	314, 336, 337
Olympic	309, 308
Optimus	327
Panasonic	308, 309, 306, 307
Pentax	305, 304
Philco	308, 309
Philips	308, 309, 310
Pioneer	308
Quasar	308, 309, 306
RCA/PROSCAN	304, 305, 308, 309, 311, 312, 313, 310
Realistic	309, 330, 328, 335, 324, 338
Sansui	314
Singer	315
Samsung	322, 313, 321
Sanyo	330, 335
Scott	312, 313, 321, 335, 323, 324, 325, 326
Sharp	327, 328
Shintom	315
Signature 2000 (M. Wards)	338, 327
Sylvania	308, 309, 338, 310
Symphonic	338
Tashiro	332
Tatung	314, 336, 337
Teac	314, 336, 338, 337
Technics	309, 308
Toshiba	312, 311
Wards	327, 328, 335, 331, 332
XR-1000	315
Yamaha	330, 314, 336, 337
Zenith	331

MDP manufacturer code numbers

Manufacturer	Code number
MDP	
Sony	701
Kenwood	707
Magnavox	703
Marantz	702
Mitsubishi	702
Panasonic	704
Philips	703
Pioneer	702
RCA	702
Sanyo	706
Sharp	705
Yamaha	703

Notes

- If more than one code number is listed, try entering them one by one, until you come to the correct code for your equipment.
- In some rare cases, you may not be able to operate your non-Sony video equipment with the supplied remote commander. This is because your equipment may use a code that is not included with this remote commander. In this case, please use the equipment's own remote control unit.
- The code numbers for Sony equipment are assigned at the factory as follows:
 VHS VCR 301 (preset code for the supplied remote commander)
 8 mm VCR 302
 Beta, ED Beta VCRs 303
- Whenever you remove the batteries — to replace them, for example — if too much time is taken, the code numbers may revert to the factory settings and must be reset.

Operating video equipment

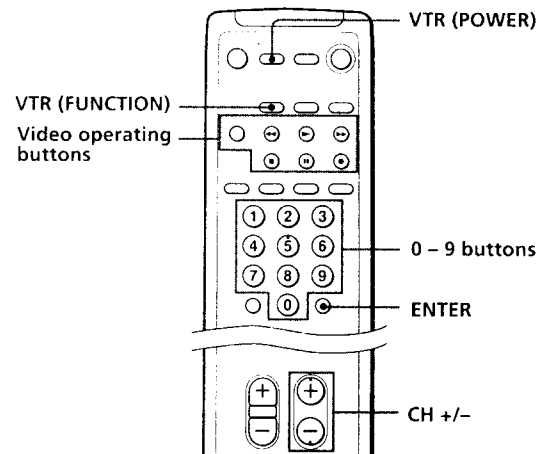

Use the video operating buttons on the remote commander to operate the video equipment. Press VTR (FUNCTION) before operating the video equipment.

Operating a VCR	Buttons on the remote commander
To turn on or off	Press VTR (POWER).
To select a channel directly	Press the 0-9 buttons.
To change channels	Press CH +/-.
To record	Press ► while pressing ●. First release ►, then release ●.
To play	Press ►.
To stop	Press ■.
To fast forward	Press ►►.
To rewind the tape	Press ◄◄.
To pause	Press . To resume normal playback, press again.
To search the picture forward or backward	Press ►► or ◄◄ during playback. To resume normal playback, release the button.
To change input mode	Press TV/VTR.

Operating an MDP	Buttons on the remote commander
To turn on or off	Press VTR (POWER).
To play	Press ►.
To stop	Press ■.
To pause	Press . To resume normal playback, press again.
To search the picture forward or backward	Keep pressing ►► or ◄◄ during playback. To resume normal playback, release the button.
To search the chapter forward and backward	Press CH +/-.

Note

- If the video equipment does not have a certain function, the corresponding button on this remote commander will not operate.

Operating a cable box or DBS receiver

You can program the supplied remote commander to operate a cable box or DBS receiver. Follow the procedures below to set the manufacturer's code number in the remote commander.

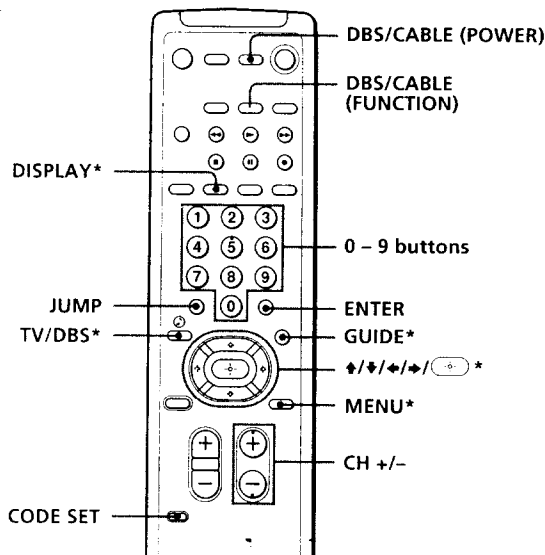

* The TV/DBS, GUIDE, DISPLAY, $\uparrow/\downarrow/\leftarrow/\rightarrow$, and MENU buttons can be used only with a DBS receiver.

1 Turn off the equipment you want to set up, and press DBS/CABLE (FUNCTION).

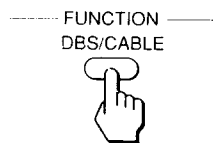

2 Press the CODE SET, DBS/CABLE (FUNCTION), and 0 - 9 buttons to enter the manufacturer's code number (see the chart), then press ENTER. For example, to program your remote commander to operate a Sony DBS receiver, press CODE SET, DBS/CABLE (FUNCTION), 8, 0, 1, and ENTER.

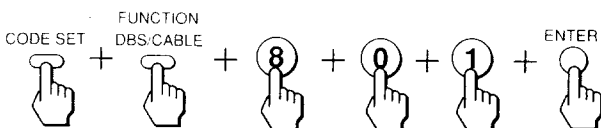

3 Press DBS/CABLE (POWER) to turn on the cable box or DBS receiver.

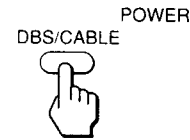

4 Use the cable box/DBS control buttons to check if the code number works.

For example, to operate a cable box or DBS receiver, you can use the DBS/CABLE (POWER), JUMP, CH +/-, 0 - 9 and ENTER buttons.

Note

- If the cable box or DBS receiver does not have a certain function, the corresponding button on this remote commander will not operate.

To operate the TV

Press TV (FUNCTION). Then use the TV control buttons to control the TV.

For more details on operating the cable box or DBS receiver

Refer to the operating instructions that come with the equipment.

If the remote commander doesn't work

- First, try repeating the setup procedures using the other codes listed for your equipment.

Manufacturer code numbers (cable box)

Manufacturer	Code number
Hamlin/Regal	222, 223, 224, 225, 226
Jerrold/G. I.	201, 202, 203, 204, 205, 206, 207, 208, 218
Oak	227, 228, 229
Panasonic	219, 220, 221
Pioneer	214, 215
Scientific Atlanta	209, 210, 211
Tocom	216, 217
Zenith	212, 213

Manufacturer code numbers (DBS receiver)

Manufacturer	Code number
Sony	801 (preset code for the supplied remote commander)
RCA	802

Notes

- If more than one code number is listed, try entering them one by one until you come to the correct code for your equipment.
- If you enter a new code number, the code number you previously entered at that setting is erased.
- In some rare cases, your equipment may use a code that is not provided with this remote commander and you may not be able to operate your equipment with the supplied remote commander. In this case, use the equipment's own remote control unit.
- Whenever you remove the batteries — to replace them, for example — if too much time is taken, the code numbers may revert to the factory setting and must be reset.

Troubleshooting

If the problem persists after trying the methods below, contact your nearest Sony dealer.

No picture (screen not lit), no sound

- Make sure the power cord is connected securely.
- Operate with the buttons on the TV.
- Insert the batteries in the remote commander with the correct polarity.
- Replace the batteries with new ones if they are weak.
- Check to see if the TV/VIDEO setting is correct: when watching TV, set to TV, and when watching video tapes, set to VIDEO1 or 2.
- Try another channel. It could be station trouble.
- Perform AUTO SET UP again using the SET UP button to return to the factory preset condition. (page 12)

Poor or no picture (screen lit), good sound

- Adjust PICTURE in the VIDEO menu. (page 17)
- Adjust BRIGHTNESS in the VIDEO menu. (page 17)
- Check antenna/cable connections.
- Perform AUTO SET UP again using the SET UP button to return to the factory preset condition. (page 12)
- Remove objects from the front of TV.
- Check the LIGHTSENSOR setting in the VIDEO menu. (page 18)

Good picture, no sound

- Press MUTING so that "MUTING" disappears from the screen. (page 15)
- Check the MTS setting in the AUDIO menu. (page 21)
- Make sure SPEAKER is set to ON in the AUDIO menu. (page 21)
- Perform AUTO SET UP again using the SET UP button to return to the factory preset condition. (page 12)

No color

- Adjust the COLOR in the VIDEO menu. (page 17)
- Black and white programs cannot be seen in color.
- Perform AUTO SET UP again using the SET UP button to return to the factory preset condition. (page 12)

Only snow and noise appear on the screen

- Check the CABLE setting in the SET UP menu. (page 14)
- Check the antenna/cable connections.
- Make sure the channel is broadcasting programs.
- Press TV (black button) to change the input mode. (page 16)

Dotted lines or stripes

- Adjust the antenna.
- Move the TV away from noise sources such as cars, neon signs, and hair-dryers.

Double images or ghosts

- Use a highly directional outdoor antenna or a cable (when the problem is caused by reflections from nearby mountains or tall buildings).

Cannot operate menu

- If the item you want to choose appears in gray, you cannot select it. Press TV/VIDEO correctly.

Cannot receive upper channels (UHF) when using an antenna

- Make sure CABLE is OFF in the SET UP menu. (page 14)
- Use AUTO PROGRAM to add receivable channels that are not presently in TV memory. (pages 13, 14)

Cannot receive any channels when using cable TV

- Make sure CABLE is ON in the SET UP menu. (page 14)
- Use AUTO PROGRAM to add receivable channels that are not presently in TV memory. (pages 13, 14)

Remote commander does not operate

- Batteries could be weak. Replace the batteries.
- Make sure the TV's power cord is connected securely to the wall outlet.
- Press TV (FUNCTION) when operating your TV.
- Are fluorescent lights too close to the TV? Move them at least 3-4 feet away from the TV.

Cannot gain enough volume when using a cable box

- Increase the volume at the cable box. Then press TV (FUNCTION) and adjust the TV's volume.

The TV needs to be cleaned

- Clean the TV with a soft dry cloth. Never use strong solvents such as thinner or benzine, which might damage the finish of the cabinet.

Specifications

	Model number			Notes
	KV-27S20 KV-29PS1 KV-29RS20 KV-29RS20C KV-29SD1	KV-27V20 KV-29V20M	KV-32S20 KV-34RS20C	
Television system	American TV standard			
Channel coverage	VHF: 2-13 / UHF: 14-69 / CATV: 1-125			
Antenna	75-ohm external antenna terminal for VHF/UHF			
Picture tube	Hi Black Trinitron™ tube			
Screen size (in.)	27	27	32	Measured diagonally
Number of inputs/outputs				
Video	1	2	1	1 Vp-p, 75 ohms unbalanced, sync negative
S video	0	1	0	Y: 1 Vp-p, 75 ohms unbalanced, sync negative C: 0.286 Vp-p (Burst signal), 75 ohms
Audio	1	2	1	500 mVrms (100% modulation), Impedance: 47 kilohms
Monitor out	0	1	0	1 Vp-p, 75 ohms unbalanced, sync negative
Audio out	1	1	1	More than 408 mVrms at the maximum volume setting (variable) More than 408 mVrms (fix) Impedance: 5 kilohms
Speaker output (W)	5W × 2	5W × 2	5W × 2	
Power requirements	a KV-27S20/29PS1/29RS20/ 29SD1 b KV-29RS20C	a	a KV-32S20 b KV-34RS20C	a= 120V, 60 Hz b= 220 V, 50/60 Hz
Power consumption (W)				
When in use	160 W (Max.)	180 W (Max.)	180 W (Max.)	
In standby	9 W	9 W	9 W	
Dimensions (W/H/D) (mm) (in.)	660.4 × 602.5 × 521.2 mm (26 × 23 3/4 × 20 5/8 in.)	690 × 575.4 × 503.4 mm (27 1/4 × 22 3/4 × 19 7/8 in.)	781 × 712.1 × 582.5 mm (30 3/4 × 28 1/8 × 23 in.)	
Mass (kg) (lbs)	40.6 kg (89 lbs 8 oz)	43 (94 lbs 13 oz)	64.3 kg (141 lbs 12 oz)	

Supplied accessories

Remote commander RM-Y135 (1)

Size AA (R6) battery (2)

Optional accessories

Connecting cables VMC-810S/820S, VMC-720M, YC-15V/30V, RK-74A

TV stand SU-27A (KV-27S20/27V20/29PS1/29RS20/29RS20C, 29SD1/29V20M only)

TV stand SU-32A (KV-32S20/34RS20C only)

U/V mixer EAC-66

Design and specifications are subject to change without notice.

● SRS (SOUND RETRIEVAL SYSTEM)

The ● SRS (SOUND RETRIEVAL SYSTEM) is manufactured by Sony Corporation under license from SRS Labs Inc. It is covered by U.S. Patent No. 4,748,669. Other U.S. and foreign patents pending.

The word 'SRS' and the SRS symbol (●) are registered trademarks of the SRS Labs, Inc.

Index

Adjusting the picture 17
Adjusting the sound 19
Antenna 5
Audio effect 20
Audio out 22
Auto program 14
Auto set up 12
Battery 11
Cable box 5
Cable TV 14
Caption Vision 27
Changing the menu language 14
Channel block 25
Channel caption 24
Current time set 23
Daylight saving 22
DBS 8, 29
DEMO 12
Erase/Add 13
Favorite channel 26
Hookup
 with a VCR 6
 without a VCR 5
Language 14
LightSensor 18
MTS (Multichannel TV Sound) 21
On/off timer 23
Presetting channels 12, 14
Remote commander 11
SAP (Second Audio Program) 21
Sleep timer 16
Speaker 21
SRS 20
Surround 20
TEXT 27
Video mode 18
Watching
 TV 15
 video tapes 28
XDS 16

Names of controls

▲/▼ buttons 13
⊕ button 13
0-9 buttons 13
AUDIO OUT jacks 9
CH (channel) +/- buttons 13, 15
CODE SET button 27
DISPLAY button 16
ENTER button 13, 15
FUNCTION (DBS/CABLE, TV, VTR) buttons 13
GUIDE button 29
JUMP button 15
MENU button 13
MONITOR OUT jacks 10
MUTING button 15
POWER (DBS/CABLE, TV, VTR) buttons 15
RESET button 17
S VIDEO input jack 6
SLEEP button 16
STAND BY/STEREO indicator 21
TIMER indicator 24
TV (black) button 12
TV/ DBS ⊕ button 20
TV/ VIDEO button 16
VHF/UHF antenna terminal 5
VIDEO 1 IN jacks 6
VIDEO 2 INPUT jacks 9
VOL (volume) +/- buttons 15