

OMRON ULTRASONIC NEBULISER

Model **NE-U17**

ULTRA **A·I·R**™

Instruction Manual

- Thank you very much for purchasing this OMRON Ultrasonic Nebuliser.
- Be sure to read this instruction manual carefully before using the unit so that you can use it safely and correctly.
- Please keep this instruction manual always at hand for future reference.

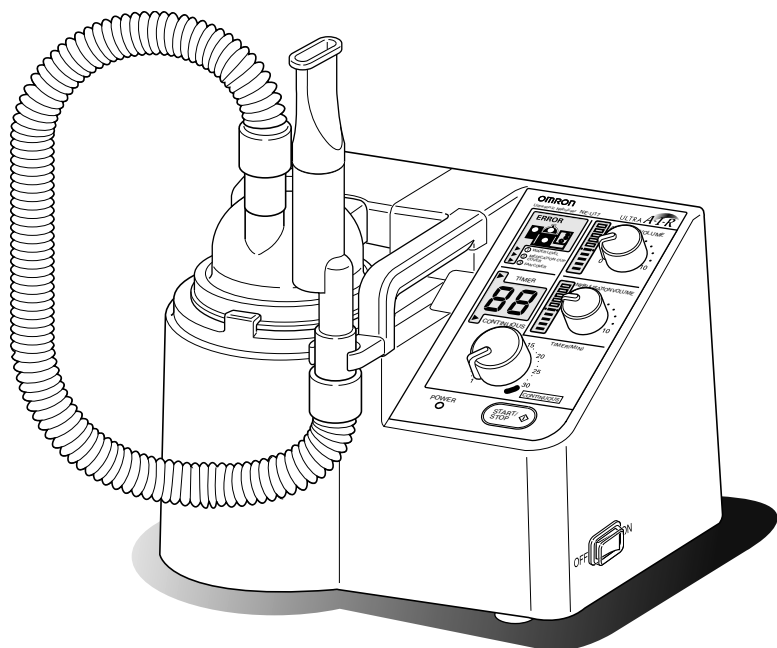

Table of Contents

Be sure to Read This Section

Exemptions from Liabilities.....	1
Intended Use.....	2
Notes on Safety.....	3

About the Product

Features of the Product.....	6
Composition of the Product.....	7
Description of the LCD Display ..	7
Names of the Parts	8

How to Use the Unit

How to Prepare the Unit before Inhalation.....	9
How to Inhale	11
How to Inhale (using optional parts)	13

How to Take Care of the Unit

How to Take Care of the Unit ...	15
How to Disinfect the Unit.....	17
How to Store the Unit.....	18

Specifications

Troubleshooting	19
Specifications	20
List of Optional Parts.....	22

■ This unit is a medical instrument. Be sure to use the unit properly according to instructions given by medical professionals. Only use medications as prescribed and instructed by your doctor.

Exemptions from Liabilities

Please understand that OMRON is not liable for the following:



1. Occurrence of trouble and/or damage caused by the maintenance and/or repair conducted by other than OMRON or OMRON's authorized dealer.
2. Trouble and/or damage of OMRON's product caused by the product of other manufacturer not delivered by OMRON.
3. Trouble and/or damage caused by the maintenance and/or repair using the repair part(s) not authorized by OMRON.
4. Trouble and/or damage caused as a result of not observing the Notes on Safety or operating method mentioned in this Instruction Manual.
5. Deviation from the operating conditions of the unit mentioned in this Instruction Manual including the power source and installation environment.
6. Trouble and/or damage caused as a result of modifying and/or improper repair of the product.
7. Trouble and/or damage caused by supreme forces such as fire, earthquake, flood, or lightning.

1. The contents of this Instruction Manual are subject to change for improvement without prior notice.
2. The contents of this Instruction Manual have been prepared with care and attention. However, if you find any omission or error, please inform your local OMRON representative or dealer.
3. It is prohibited to copy all or a part of this Instruction Manual without getting OMRON's permission. Unless you use this Instruction Manual for your personal (corporate) purpose, you are not allowed to use it without OMRON's permission in accordance with the Copyright Act.







Medical Purpose	This product is intended to be used for inhaling medication for respiratory disorders or for humidification in combination with oxygen therapy.												
Intended User	<ul style="list-style-type: none">• Legally certified medical experts, such as doctor, nurse and therapist, or healthcare personnel or patient under the guidance of qualified medical experts.• The user should also be capable of understanding general machine operation and the content of instruction manual.												
Intended Patients	This product should not be used by patients, who are unconscious or are not breathing spontaneously.												
Environment	This product is intended for use in a medical facility, such as Hospital, clinic and doctor's office.												
Durable period	<p>Durable periods are as follows, provided the product is used to nebulise saline 3 times a day for 10 minutes each time at room temperature (23°C). Durable period may vary depending on usage environment.</p> <table><tr><td>Main unit</td><td>5 years</td></tr><tr><td>Inhalation hose(M) with a cuff, 70cm</td><td>1 year</td></tr><tr><td>Mouthpiece set</td><td>1 year</td></tr><tr><td>Inhalation mask(L)</td><td>1 year</td></tr><tr><td>Nebulisation set</td><td>1 year</td></tr><tr><td>Medication cup</td><td>6 months</td></tr></table>	Main unit	5 years	Inhalation hose(M) with a cuff, 70cm	1 year	Mouthpiece set	1 year	Inhalation mask(L)	1 year	Nebulisation set	1 year	Medication cup	6 months
Main unit	5 years												
Inhalation hose(M) with a cuff, 70cm	1 year												
Mouthpiece set	1 year												
Inhalation mask(L)	1 year												
Nebulisation set	1 year												
Medication cup	6 months												
Precautions for use	Warnings and cautions described in the instruction manual should be observed.												





Notes on Safety

- The warning signs and the sample icons shown here are listed for you to use this product safely and correctly as well as to prevent the risk of injury to you and others.
- The icons and meanings are as follows.





Warning sign	Contents
 Warning	Indicates matters in which the possibility of death or severe bodily injury may arise as a result of incorrect handling.
 Caution	Indicates matters in which bodily injury or material damage* may arise as a result of incorrect handling.

* Material damage refers to a wide range of damage involving your house, household goods, domestic animals, and pets.

Examples of signs				
The △ icon indicates caution (including warning and danger). Matters involving actual caution are indicated by statements or pictures in or near △.		The pictured icon refers to "caution for flammability".		The pictured icon refers to "caution for electric shock".
The ⊘ icon indicates prohibitions (what you cannot do). Matters involving specific prohibitions are indicated by text or pictures shown in or near ⊘.		The pictured icon refers to "prohibition to disassemble".		The pictured icon refers to "general prohibition".
The ● icon indicates something that is compulsory (must be observed at any time). Matters involving specific compulsory actions are indicated by statements or pictures shown in or near ●.		The pictured icon refers to "general compulsion".		The pictured icon refers to "unplugging the power plug".

 Warning	
<p>Only use medications as prescribed and instructed by your doctor.</p> <ul style="list-style-type: none"> • Your physical conditions may change for the worse. <p>When you use the unit for the first time after purchasing it or after having not used it for a long time, be sure to clean and disinfect it. (Refer to Pages 15 to 17.)</p> <ul style="list-style-type: none"> • Miscellaneous types of bacteria may propagate and you may get infected. <p>Clean and disinfect the medication cup, medication cup cover, mouthpiece and inhalation hose, each time the unit is used.</p> <ul style="list-style-type: none"> • Miscellaneous bacteria may propagate and you may become infected. If the unit is going to be used by more than one person, prepare a disinfected medication cup, medication cup cover, mouthpiece and inhalation hose, for each person before using it. This will prevent cross-infection. <p>Be sure to immediately dry the cleaned and disinfected parts, then store them in a dry place in order to prevent them from getting contaminated in the future.</p> <p>In case of any problem with your nebuliser please contact your local OMRON service representative (address on/ inside package).</p>	
<p>Do not use this device in combination with ventilation equipment.</p> <ul style="list-style-type: none"> • The pressure in the ventilation system may reduce significantly. <p>When assembling the cleaned, disinfected, and dried parts, do not touch the places where the medication and the nebulised medication pass through directly with your hands to prevent possible infection.</p> <p>Do not make any contact with the vibrator while the power plug is plugged into the electric outlet.</p> <ul style="list-style-type: none"> • You may suffer electric shock or injure yourself. 	
<p>Do not plug in or pull the power plug from the electric outlet with wet hands.</p> <ul style="list-style-type: none"> • You may suffer electric shock or injure yourself. <p>Do not wash the main unit with water, or splash water to the power source, do not use the nebuliser while you are in bath or having a shower, never submerge the nebuliser in water.</p> <ul style="list-style-type: none"> • Short circuit may occur in the unit or you may suffer electric shock. 	

Caution

<p>If the nebulisation parts have already become dirty before using the unit, clean them first before use.</p> <ul style="list-style-type: none"> • If the medication remains in the nebulisation unit, your physical conditions may change for the worse. <p>Wash off the remaining medication in the parts thoroughly with water after cleaning these parts with disinfectant.</p> <ul style="list-style-type: none"> • If you inhale with the remaining disinfectant in the parts, your physical conditions may change for the worse. <p>Replace the water in the water tank each time you use the unit.</p> <ul style="list-style-type: none"> • A dirty vibrator may cause lower nebulisation rate. <p>If the medication is attached to the fan installation axis, wipe it off.</p> <ul style="list-style-type: none"> • Overheating may cause the motor to stop. <p>Disposal of this product should be carried out in accordance with the national regulations for the disposal of electronic products.</p>	
<p>If you are not going to use the unit for a long time, be sure to unplug the power plug from the electric outlet.</p> <ul style="list-style-type: none"> • You may suffer electric shock or the unit may ignite due to electric leakage. <p>Be sure to turn off the power and unplug the power plug from the electric outlet when you install, or remove the device, or take care of the parts.</p> <ul style="list-style-type: none"> • You may suffer electric shock or injure yourself. 	
<p>Do not look into the nebulisation section during nebulisation.</p> <ul style="list-style-type: none"> • A large amount of medication may get into your eyes and cause injury. <p>Do not operate the unit when the medication cup is empty.</p> <ul style="list-style-type: none"> • The unit may become overheated or damaged. <p>Do not fill the water tank with the liquid other than water (tap water or distilled water).</p> <ul style="list-style-type: none"> • The vibrator will deteriorate and may be damaged. <p>When parts are sterilised in an autoclave, make sure these parts do not directly contact the heater inside the autoclave.</p> <ul style="list-style-type: none"> • As the temperature of the heater is very high, these parts may be melted or deformed. <p>Do not use the power cord or the power plug if it is damaged, or do not plug the power cord into a loose electric outlet.</p> <ul style="list-style-type: none"> • You may suffer electric shock or the unit may be shorted or ignite. <p>Do not scratch, tear, modify, forcibly bend, pull, twist, or bundle the power cord. Do not place a heavy material on the power cord. Keep power cord away from heated or hot surfaces.</p> <ul style="list-style-type: none"> • You may suffer electric shock or the unit may ignite due to short circuit because of deteriorated insulation. 	
<p>Do not disassemble, repair, or modify the unit.</p> <ul style="list-style-type: none"> • The unit may malfunction or cause injury. <p>Contact your nearest OMRON service representative.</p>	
<p>Do not use a power cord other than the supplied one.</p> <ul style="list-style-type: none"> • The unit may ignite or you may suffer electric shock. <p>Be sure to use the power source as specified on the device.</p> <ul style="list-style-type: none"> • The unit may ignite or you may suffer electric shock. <p>Do not share the electric outlet with other electric appliances.</p> <ul style="list-style-type: none"> • The unit may ignite or you may suffer electric shock. <p>To unplug the power plug from the electric outlet, do not pull the power cord, instead hold the power plug with your hand.</p> <ul style="list-style-type: none"> • The power cord may be broken or short-circuited and cause fire or you may suffer electric shock. 	

General Advice

Do not use the unit for the purpose other than for inhalation.

Do not use any parts other than the accessories or the optional parts listed on page 22.

Do not fill the medication cup with more than 150 ml medication or less than 5 ml.

- The unit may not nebulise.

Do not move the unit while medication remains in the unit.

Do not block the air ventilation holes at the rear side of the nebuliser.

Place the nebuliser on a plain and stable surface during operation.

Do not apply strong shocks to or drop the main unit.

Do not bend the inhalation hose.

- The medication may be pooled in the hose and the nebulisation rate may be lowered.

Do not inhale from the inhalation hose if the main unit is higher than your head.

- The medication may spill onto your face or clothes.

Be careful not to damage the vibrator when cleaning the water tank of the main unit.

Do not disinfect the unit by boiling in a microwave oven.

After cleaning and disinfecting the parts, assemble them after they are completely dried.

Do not wipe the main unit with volatile chemicals, such as benzene or thinners.

Although this nebuliser fulfils the provisions of the EMC (Electromagnetic Compatibility) directive, the use of it should be avoided in direct vicinity of other electric devices.

Do not allow unsupervised children or infirm persons to use the unit.

Maintenance

Before using the unit, be sure to confirm that the main unit operates normally and safely.

How to handle faults or accidents

If an equipment error (E1) occurs, immediately take the following measures. (Also refer to Page 19.)

- (1) Power-off the unit and unplug the power plug from the electric outlet to make the unit inoperable.
- (2) Write "Faulty-Do not use" on the main unit so that it will not be used.
- (3) Contact the store where you purchased the unit or the nearest OMRON dealer.

About the principle of nebulisation in the NE-U17

- ① The NE-U17 transmits the energy of ultrasonic vibration from the vibrator located at the bottom of the water tank into water.
- ② The ultrasonic vibration is transmitted to the medication in the medication cup through the water in the water tank.
- ③ The ultrasonic vibration emits medication from the medication cup (like a fountain) and this is dispersed as aerosol.
- ④ Air from the fan carries this nebulised medication out of the medication cup.
– Nebulisation: The state in which the medication is converted into aerosol.

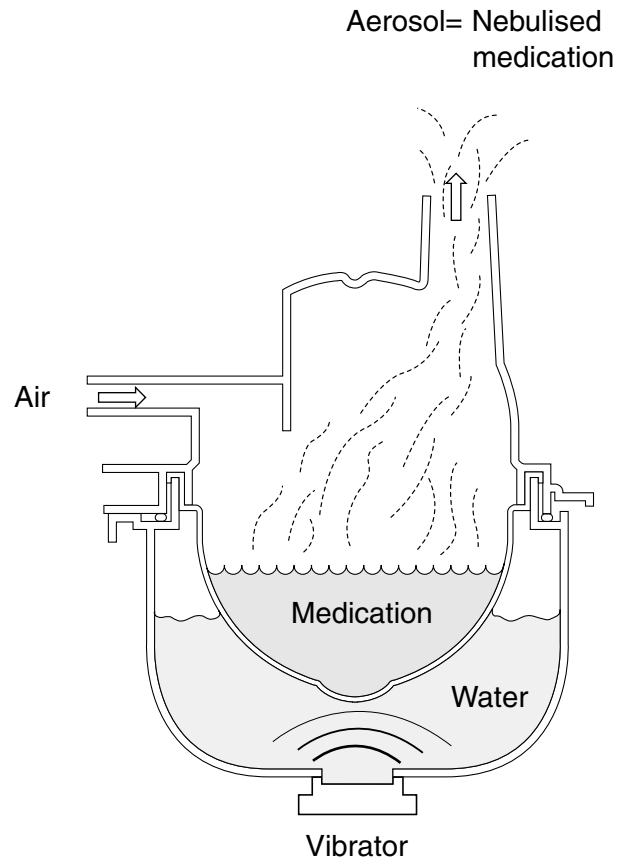

Features of the Product

- 1** Easy to see large LCD displays air volume, nebulisation rate, set time, remaining time, and error location. The back-light illumination featured in the unit enables checking of the display in the dark.
- 2** The unit can nebulise for 72 hours continuously (with the use of the optional long-time nebulisation set and the supply medication set).
- 3** The unit has a notification buzzer. The buzzer sounds when an error occurs or the time set by the timer is completed.
- 4** With the use of a dial, the air volume, nebulisation rate, and time can be set easily and quickly. The unit can handle various inhalation therapies with the use of various optional parts.

Composition of the Product

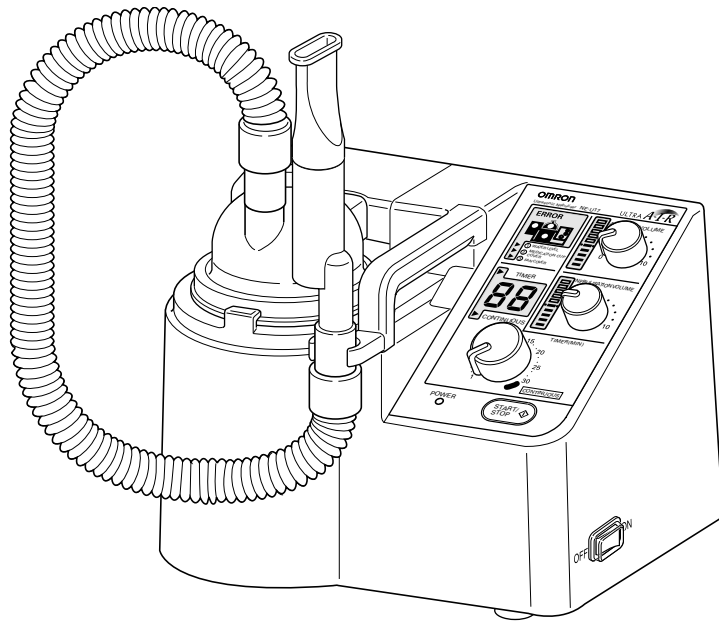

Main unit

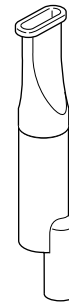

Mouthpiece set

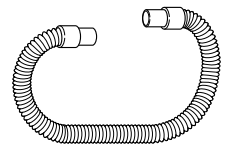

Inhalation hose (M) with a cuff, 70 cm

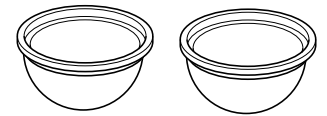

Two medication cups

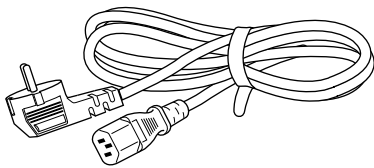

Power cord
 – As the unit is a Class I electroshock protection type, be sure to use only the supplied power cord with an “earth”.

■ **Instruction manual (with warranty card)**

For the optional parts, refer to the “List of Optional Parts” on Page 22.

Description of the LCD Display

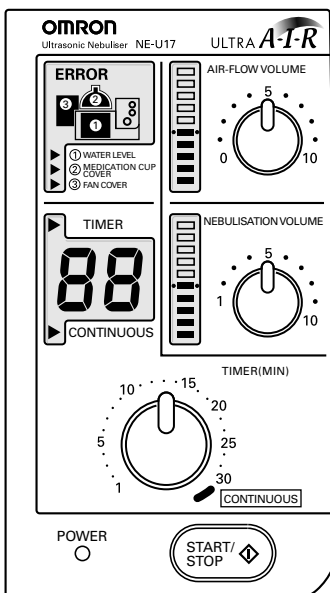

Display of air volume:

The “air volume” is displayed in 11 levels.

Display of nebulisation rate:

The “nebulisation rate” is displayed in 10 levels.

When the timer is used:

A timer mark ► illuminates and the buzzer beeps to notify the end time.

For continuous operation:

A continuous operation mark ► illuminates and the digital display indicates this.

ERROR display

When the water level in the water tank is too low or the medication cup cover or the fan cover is not installed, the corresponding error location is indicated at the upper left corner of the panel.

(For the error display, refer to Page 19.)

Names of the Parts

* indicates replaceable supplies.

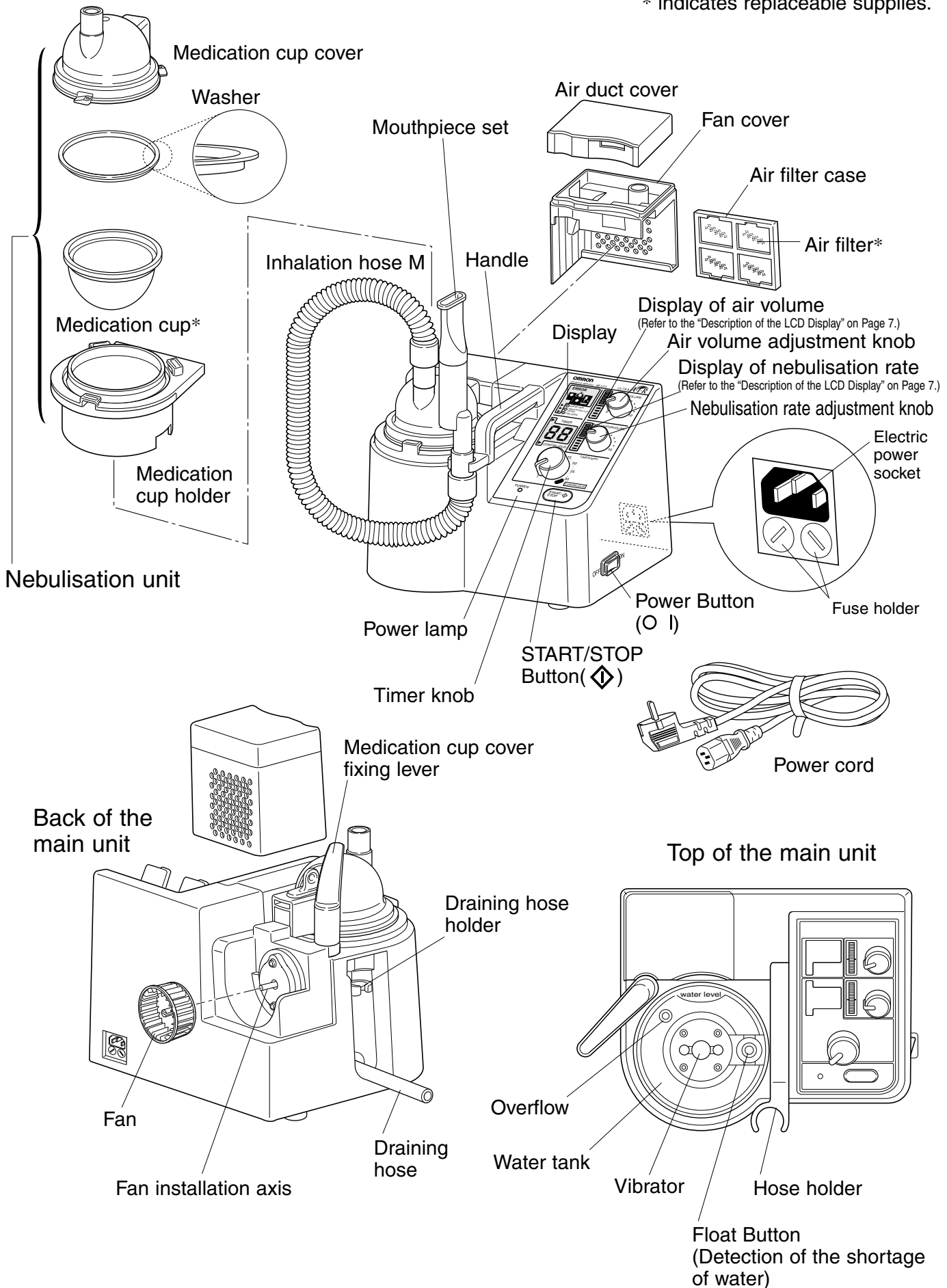

How to Prepare the Unit before Inhalation

– Clean the parts before starting the inhalation.

[Parts that can be disinfected by boiling]

(For the disinfecting method, refer to Page 17.)

Submerge these parts in a container filled with sufficient water and boil for 10 minutes.

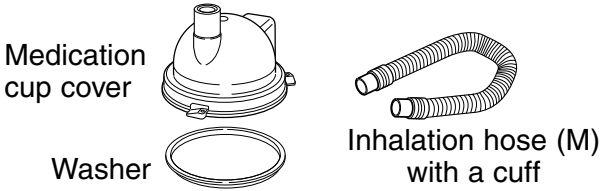

How to remove the washer

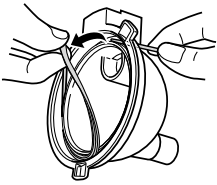

Place the medication cup cover on its side and insert a small item (such as a paper clip) into the hole of the cover. Pinch and remove the washer gently.

How to attach the washer

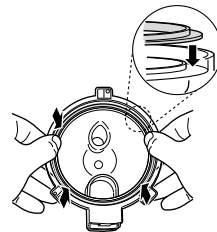

Hold the medication cup cover and place the washer securely with your fingertips as illustrated in the figures on the left. Make sure the washer is placed flat and not upside down.

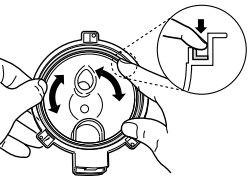

[Parts that cannot be disinfected by boiling]

(For the care and disinfection, refer to Page 17.)

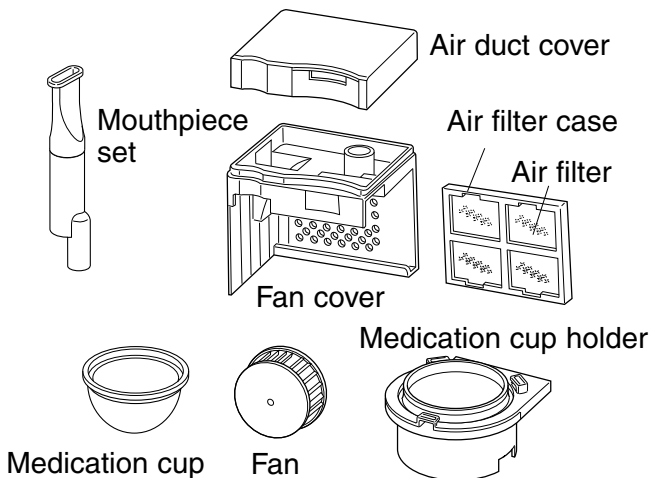

Warning

Be sure to immediately dry the cleaned and disinfected parts, then store them in a dry place in order to prevent them from getting contaminated in the future.



1

Filling the cooling water.

1) Remove the nebulisation section by rotating the medication cup cover-fixing lever clockwise.

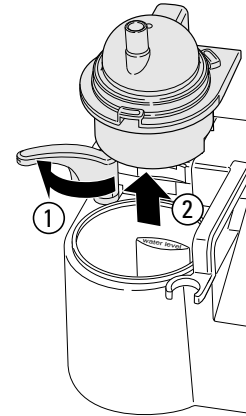

2) Fill the cooling water.

Fill the cooling water up to the “water level” mark that specifies the water level in the water tank. The proper amount is approximately 375 ml.

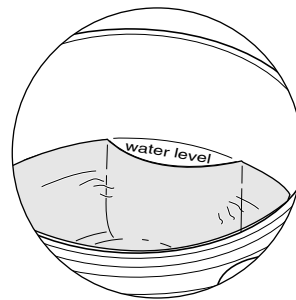
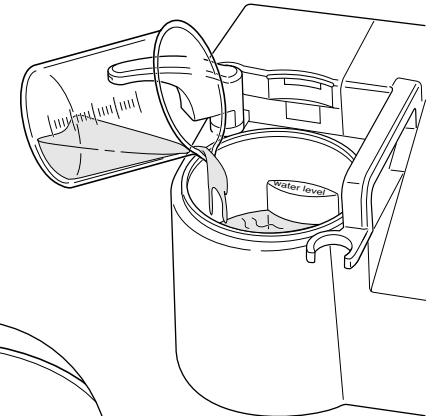

- If the water level in the water tank is lower than the “water level” mark, a “lower water level in water tank” error will be displayed.
- If the water temperature in the water tank is low, the nebulisation rate may drop. (Recommended temperature is approximately 26°C (78.8 °F).)
- Replace water in the water tank each time the unit is used.
- When the unit is used for a long time continuously, replace water at least every twenty-four hours. (For continuous use or long periods, refer to Page 13.)

How to Prepare the Unit before Inhalation

2 Filling medication into the medication cup.

- 1) Remove the medication cup cover by rotating it counterclockwise.

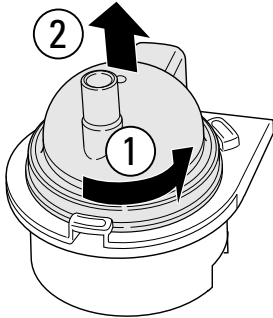

- 2) Fill medication into the medication cup.

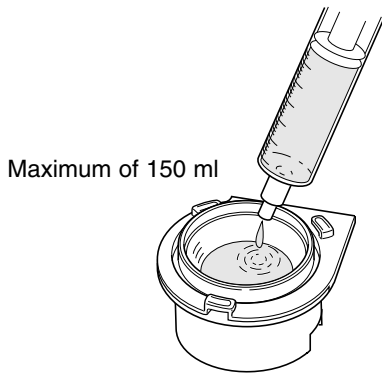

Minimum of 5 ml.

- 3) Assemble the medication cup cover by turning it clockwise, then install it to the main unit.

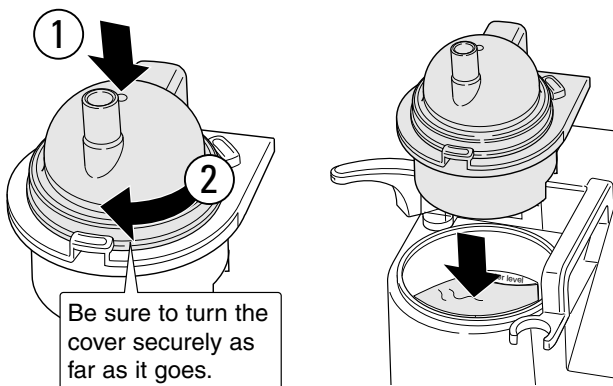

3 Assembling and attaching the nebulisation unit to the main unit

- 1) Fix the nebulisation unit by rotating the medication cup cover-fixing lever counterclockwise.

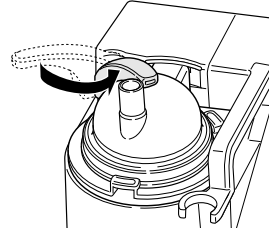

- 2) Attach the inhalation hose and the mouthpiece set.

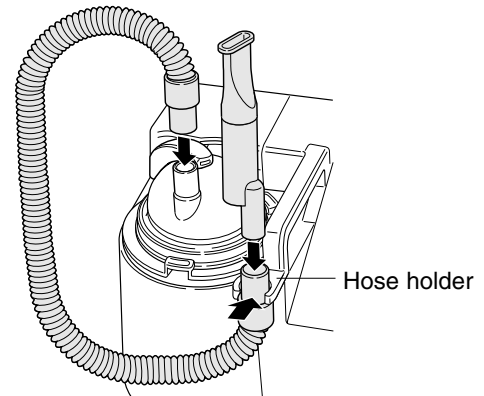

- 3) Turn on the Power Button (○ I). After all items on the LCD display illuminate, check that the “ERROR display” does not flash.

If the “ERROR display” flashes, check the place where the error number is indicated by referring to Page 19.

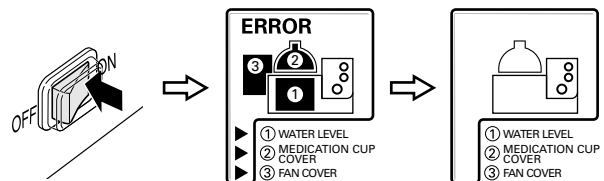

All items on the display illuminate.

Now the preparation for inhalation is completed.

Note: As soon as the Power Button (○ I) is turned on, the fan to cool the parts inside the main unit will start rotating. This is normal.

How to Inhale

1

Setting the inhalation time.

Setting the inhalation time by rotating the timer knob clockwise.

1) To set the timer

The timer can be adjusted by 1 minute when setting the time up to 15 minutes.

Please note that the timer has intervals of 1 or 2 minutes between 15 and 30 minute timer settings.

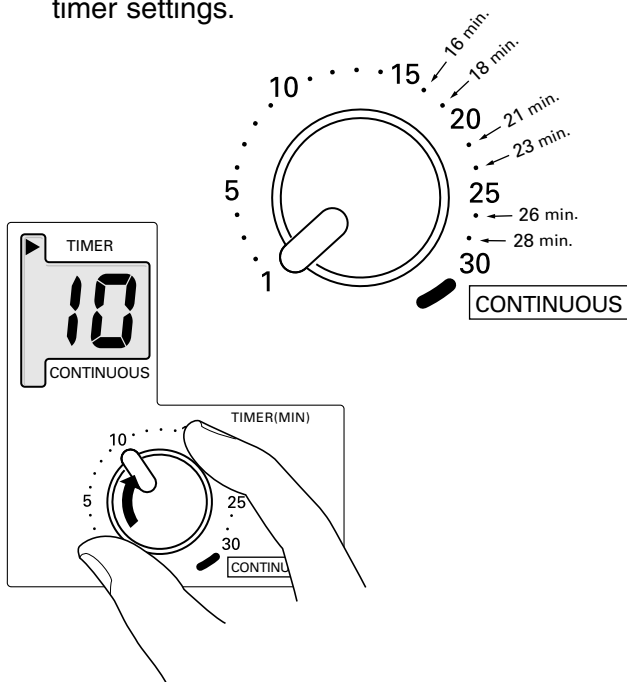

2) Continuous nebulisation

Turn the timer knob clockwise to the position of “continuous”.

The display of “Continuous” on the timer will turn on and the digital characters will rotate to indicate that the unit is in the continuous operation.

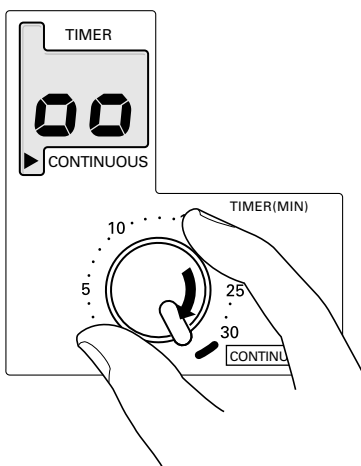

2

Push the START/STOP Button (◊).

The fan will rotate and the unit starts to nebulise.

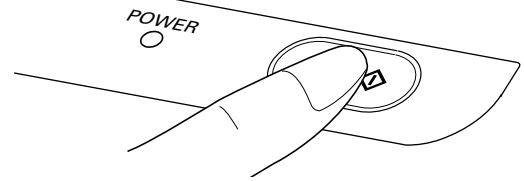

When the timer is used:

The display counts down by 1 minute.

To change the setting during the operation:

Turn the timer knob to the desired time. The timer is reset and the unit starts to operate.

Adjust the air volume and the nebulisation rate.

Adjust the air-flow volume and the nebulisation rate with the “air volume” knob and the “nebulisation volume” adjustment knob while observing the aerosol coming out from the inhalation hose.

- For inhalation using the accessories such as mouthpiece, adjust the air volume and the nebulisation rate according to your preferences and the accessories being used.

The air volume (11 levels) and the nebulisation rate (10 levels) can be checked by the “level display” adjacent to each knob.

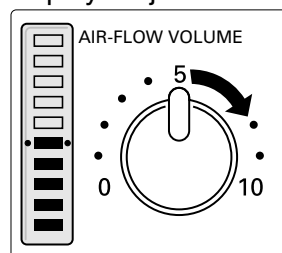

The air-flow volume adjusts the volume of air sent through the medication cup cover.

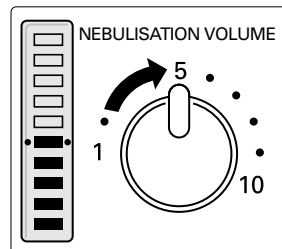

The nebulisation volume adjusts the rate of aerosol released from the medication.

- Depending on the type of the medication, nebulised aerosol may not come out constantly.
- Medication with high viscosity and surface tension may have a lower nebulisation rate.
- When the unit starts to operate with the medication volume of 150 ml and the air volume and the nebulisation rate at level “10”, it nebulises intermittently. In this case, adjust the nebulisation rate by the nebulisation rate adjustment knob.

3 Inhaling the aerosol.

<Example of correct use>

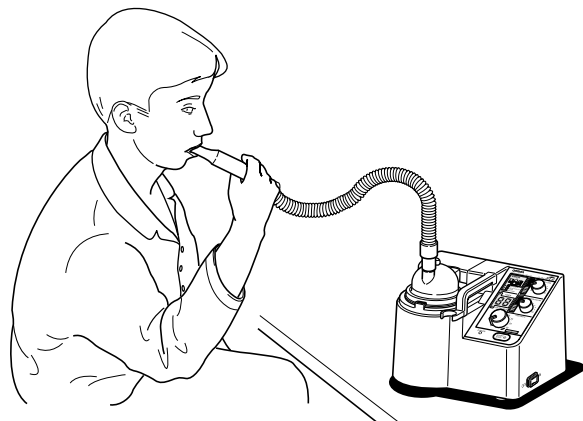

You can use an optional inhalation mask instead of a mouthpiece.

Wrong examples of use:

Do not bend the inhalation hose or block the nozzle.

- The medication will be pooled in the hose and the nebulisation rate may be lowered.

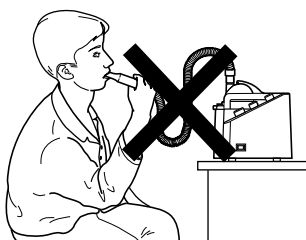

Do not use the unit if the main unit is higher than your head.

- The medication may splash onto your face or clothes.

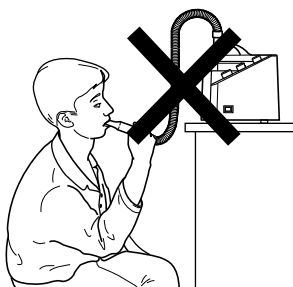

In the following cases, the buzzer sounds and the unit stops operation.

- When the time set by the timer is completed
- When the medication cup cover is removed during inhalation
- When the amount of water in the water tank is far from sufficient
- When the fan cover is removed

In case the buzzer sounds due to an error, the error display flashes. Push the START/STOP Button (◊), then the buzzer will stop.

In this case, check the error display and inspect the unit by referring to Page 19.

4 Finishing the treatment.

When the timer is used:

The buzzer sound notifies the completion of time set by the timer and the unit stops operation.

When the operation ends, "0" on the display illuminates and the display changes to the initial set time.

Sample display when the timer is set to 10 minutes.

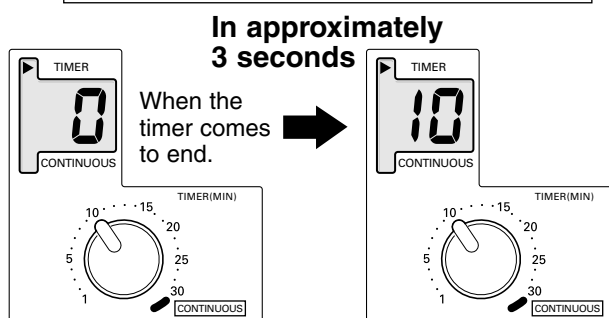

To terminate inhalation while using the timer, push the START/STOP Button (◊), then the unit stops operation.

At this time, the remaining time is reset and the timer returns to the initial set time.

To start inhalation again, push the START/STOP Button (◊).

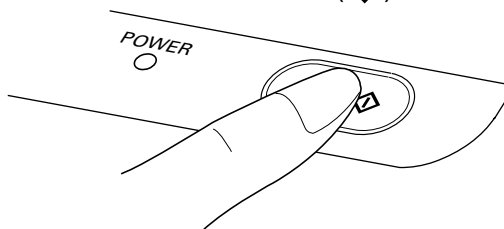

Caution: In case the treatment is paused by pressing START/STOP button, be sure to re-enter the remaining time, before the treatment is resumed.

To terminate the inhalation during the continuous operation, push the START/STOP Button (◊), then the unit stops operation.

To start the inhalation again, push the START/STOP Button (◊), then the unit will start continuous operation.

When the inhalation is finished, turn off the power and unplug the power cord from the electric outlet.

How to Inhale (Using Optional Parts)

1 Using the unit for a long time

By using the optional “long time nebulisation set (4997217-7)” and the “supply medication set (4997206-1)”, the unit can nebulise continuously for a long time.

- ① Remove the medication cup cover of the main unit. Attach an optional long time nebulisation set in place of the medication cup cover and assemble the unit according to the procedure shown on Page 10.
At this time, check that the air duct is not blocked by the air duct cap.
- ② Fill medication into the supply medication bottle.
- ③ Tightly close the supply medication bottle cap. At this time, check that the washer is correctly set inside the cap.
- ④ Remove the cap of the supply medication pipe of the long time nebulisation set and attach the tube of the supply medication set.
- ⑤ Hang the supply medication bottle on a proper place, higher than the device.
At this time, check that the tube is not bent. If the tube is bent, the medication cannot be supplied. If the tube is too long, cut it to a proper length.
Attach the inhalation hose.
- ⑥ Set the timer to “Continuous”.
- ⑦ Turn the air volume adjustment knob to the far right (the position of 10).
- ⑧ Push the START/STOP Button (◊) and start inhalation.

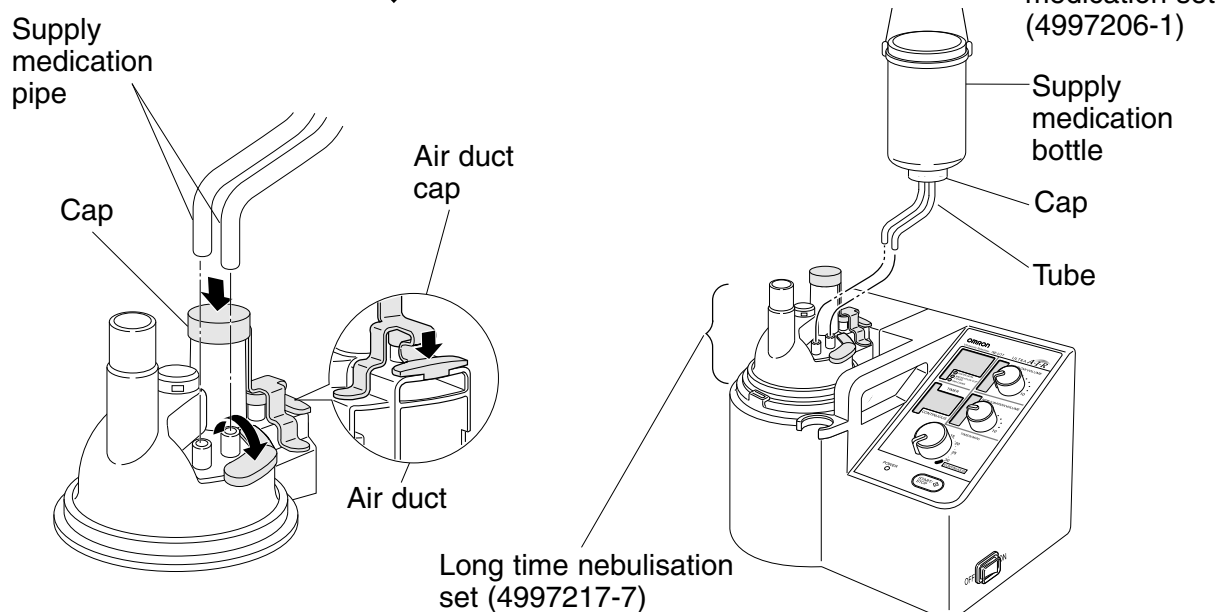

2 Using the unit for (oxygen) humidification

If you use the unit for humidification in combination with oxygen therapy, connect the equipment to the oxygen supply pipe of the “long time nebulisation set” (optional, 4997217-7). Please refer to the illustration on the next page.

In order to stop the air from the fan on the main unit during the oxygen therapy, set the “air-flow volume” adjustment knob to “0”, and attach an air duct cap to the air duct of the long time nebulisation set.

The operating and inhalation methods are the same as those of the normal operation.

How to Inhale (Using Optional Parts)

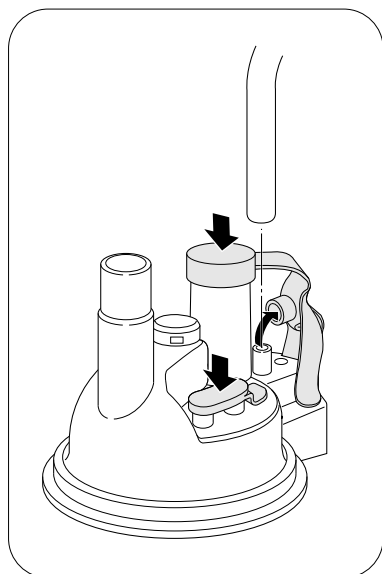

Oxygen supply pipe

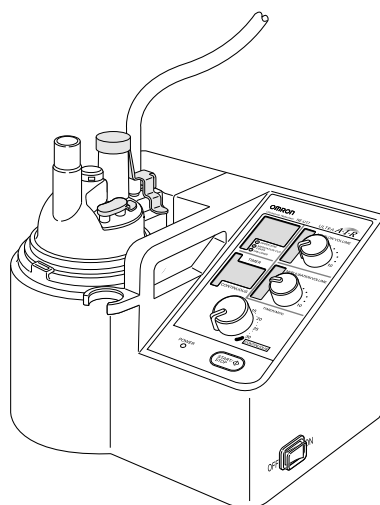

3 Using a bacterial filter

Having passed through a bacterial filter, the filtered air can be supplied to the inside of the long time nebulisation set.

- ① Remove the medication cup cover and assemble the long time nebulisation set with the main unit.
To assemble, use the long time nebulisation set in place of the medication cup cover by following the procedure shown on Page 10. At this time, close the air duct with the air duct cap.
- ② Remove the air duct cover from the main unit.
- ③ Remove the bacterial filter cap of the long time nebulisation set.
- ④ Attach a bacterial filter to the long time nebulisation set.
- ⑤ Attach a connector to the bacterial filter.
- ⑥ Attach the inhalation hose to the connector and connect the other end of the hose to the air duct of the fan cover.
– When using the bacterial filter, set the “air volume adjustment knob” to “10”.

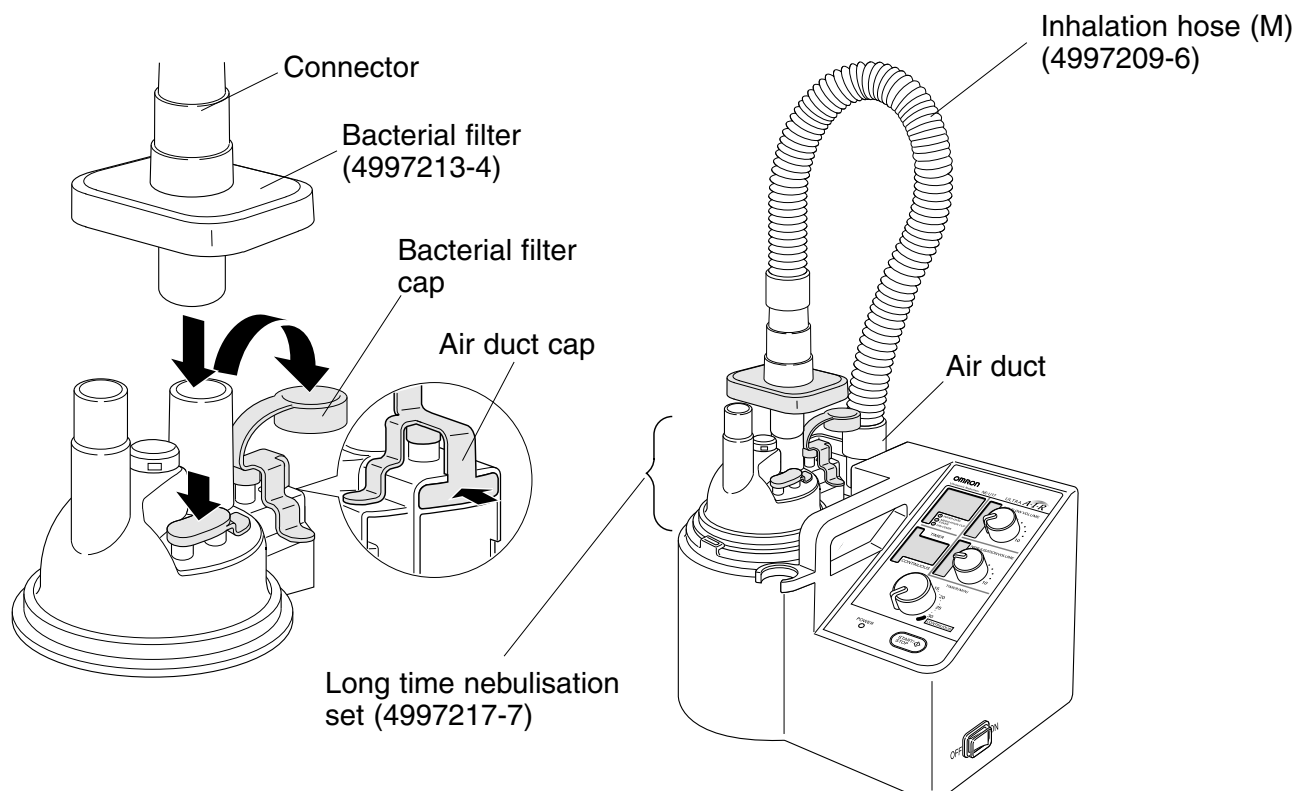

How to Take Care of the Unit

How to Take Care of the Parts

- 1 Turn off the power by pushing the ON/OFF Button (O I), and unplug the power plug from the electric outlet.

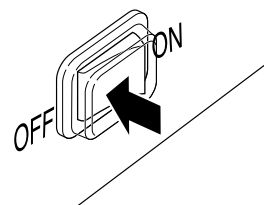

- 2 Remove the mouthpiece set, or inhalation mask.

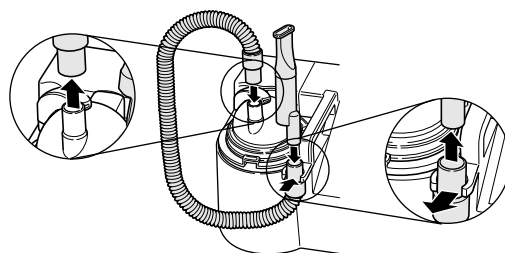

- 3 Rotate the medication cup cover-fixing lever clockwise.

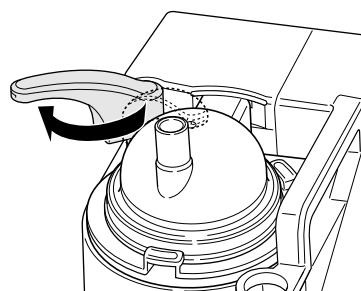

- 4 Remove the nebulisation unit for disassembling.

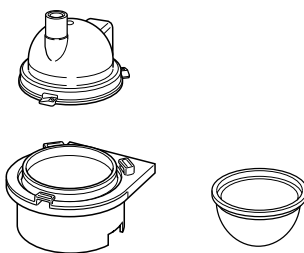

- 5 Discard the remaining medication. Discard the cooling water in the water tank by using the draining hose.

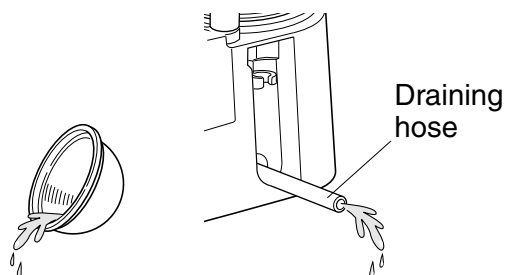

- 6 Clean and disinfect the parts.

- Wipe the inside of the water tank by using alcohol.
- Clean, disinfect, and immediately dry the medication cup cover, medication cup holder, medication cup, inhalation hose, mouthpiece set. (For the disinfection method, refer to Page 17.)

Warning

When assembling the cleaned, disinfected, and dried parts, do not touch the places where the medication and the nebulised medication pass through directly with your hands to prevent possible infection.

Do not make any contact to the vibrator while the power plug is plugged into the electric outlet.

- You may suffer electric shock or injure yourself.



How to Take Care of the Unit

How to Take Care of the Air Filter

Replace the air filter when it becomes dirty.

- ① Remove the nebulisation unit from the main device.
- ② Remove the fan cover by lifting it up.
- ③ Remove the air filter case from inside the fan cover.
- ④ Remove the air filter from the air filter case to replace with a new one.

Assemble the above mentioned parts in the reverse order.

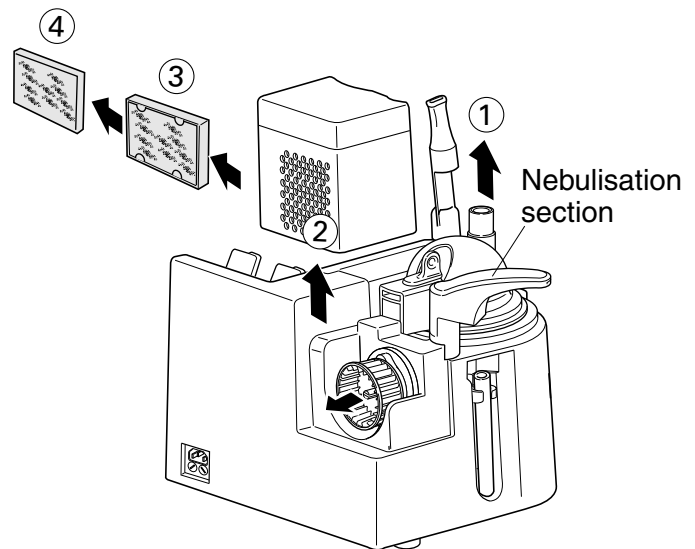

How to Take Care of the Fan

Open the fan cover and remove the fan.
Clean the fan by washing it with water or detergent.

– If the medication is stuck to the fan installation axis, remove the medication.

Remove the fan cover by lifting it up after removing the nebulisation unit from the main device. The dirty fan cover can be washed with water or detergent.

In order to install the fan, position the fan to the fan installation axis securely as far as it goes.

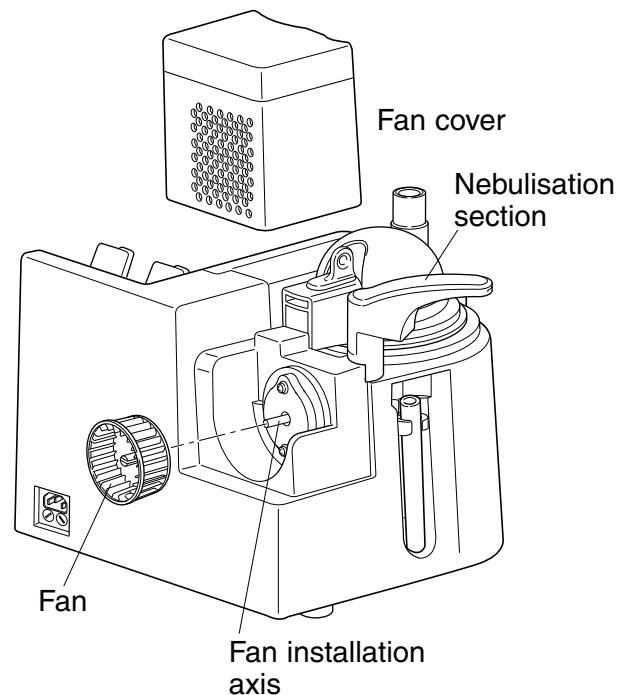

How to Take Care of the Main Unit

Clean the dust on the main unit by wiping it with a lightly squeezed cloth after being moistened with water or alcohol.

After draining water from the water tank of the main unit through the draining hose, wipe off the leftover water with a clean and dry cloth.

General Advice

- Do not wipe the main unit with volatile chemicals, such as benzine or thinners.
- Do not damage the surface of the vibrator.

How to Disinfect the Unit

How to Disinfect the Unit

Disinfection by boiling cannot be done to some parts. They may become deformed.

[Parts that can be disinfected by boiling]

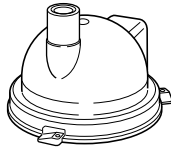

Medication cup cover



Washer

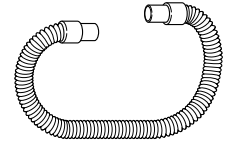

Inhalation hose (M) with a cuff, 70 cm

[Parts that cannot be disinfected by boiling]

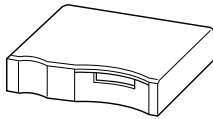

Air duct cover

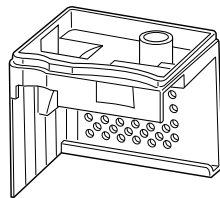

Fan cover

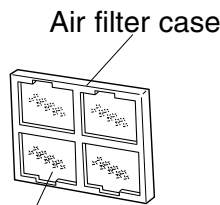

Air filter

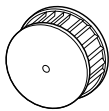

Fan



Medication cup

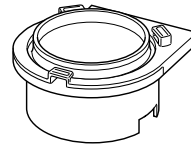

Medication cup holder

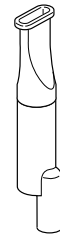

Mouthpiece set

Disinfection by disinfectant

Different disinfectants have different anti-bacterial actions. For sterilization and disinfection, follow the instruction manual and the notes on each disinfectant.

The time to immerse the parts in the disinfectant differs with the type of the disinfectant used. However, 30 to 60 minutes or longer is common.

After immersing the parts, wash them sufficiently with water and dry promptly. Carefully store the parts so that they are not re-infected.

If a coloured disinfectant solution such as Hibitane is used, some parts may be discoloured with repeated use. However, it does not affect the nebulising properties.

[Typical disinfectants that can be used]

- Disinfecting ethanol
- Glutaraldehyde: Sterihyde (0.5%) (and other equivalent products)
- Sodium hypochlorite: Milton (0.1%), Purax (0.1%) (and other equivalent products)
- Benzalkonium chloride: Osvan (0.1%)
- Chlorhexidine: Hibitane (0.5%), Maskin (0.5%)
- Amphetamine surfactant: Tego (0.2%) (and other equivalent products)

Note: These products cannot be used for the air filter.

Warning

Be sure to immediately dry the cleaned and disinfected parts, then store them in order to prevent them from getting contaminated in the future.

- Miscellaneous types of bacteria may propagate and you may get infected.



Do not wash the main unit with water, or splash water to the power source.

- Electric leakage may occur in the unit or you may suffer electric shock.



How to Disinfect and Store the Unit

Sterilization with ethylene oxide gas (E.O.G.)

Observe the Instruction Manual of the sterilizer and consult with the manufacturer of the E.O.G. sterilizer for the details.

Some of the rubber and plastic parts of the nebuliser may have residual ethylene oxide gas. After sterilization, consult with the manufacturer of the sterilizer and provide sufficient aeration until the safe level to human beings can be obtained.

The equipment and the parts to be sterilized by E.O.G. must be sufficiently dried in advance. Wash and dry the parts, then conduct the E.O.G. sterilization.

Sterilization by autoclave

Refer to the Instruction Manual and the Notes on Handling of the sterilizer.

[Option parts that can be sterilized by autoclave]

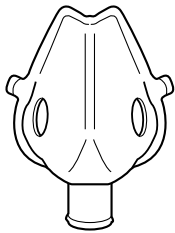

Inhalation mask (L)
(4997205-3)

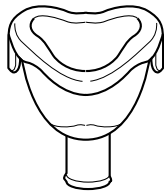

Inhalation mask (S)
(4997207-0)



Caution

When parts are sterilised in an autoclave, make sure these parts do not directly contact the heater inside the autoclave.

* As the temperature of the heater is very high, these parts may be melted or deformed.



How to store the unit



Store the parts after thoroughly drying them.

When storing the parts, be careful for the infection.

Do not store the unit under direct sunlight, where temperature and humidity are high, in a dusty place, where they can be easily sprayed with water, or where vibration or shock can be easily applied.

Troubleshooting

Trouble	Where to Inspect	How to Correct
The power lamp does not illuminate.	Is the power plug securely plugged into the electric outlet?	Plug the power plug in the electric outlet correctly. (Refer to Page 10.)
The unit does not nebulise.	Is ① of ERROR display flashing due to insufficient amount of water in the operating chamber?	Fill the water up to the specified water level mark in the operating chamber. (Refer to Page 9.)
	Is the medication cup correctly set to the main unit?	Set the medication cup correctly. (Refer to Page 10.)
	Is the fan cover open?	Close the fan cover correctly.
	Is the fan set?	Set the fan properly.
	Is the amount of medication in the medication cup too much?	Reduce the amount of medication to less than 150 ml. (Refer to Page 10.)
	Is the inhalation hose bent and the medication pooled in the hose?	Adjust the bent hose correctly and drain the pooled medication. (Refer to Page 12.)
The nebulisation rate is low. The nebulisation power is lowered.	Is the amount of medication in the medication cup too small?	Increase the amount of medication to more than 5 ml.
	Is the lower portion of medication cup damaged or deformed?	Replace the medication cup with a new one.
	Is the amount of medication in the medication cup much?	Reduce the amount of medication to less than 150 ml. (Refer to Page 10.)
	Is the value of nebulisation rate adjustment knob or the air volume adjustment knob set too low?	Turn the knob to the right and adjust the value. (Refer to Page 11.)
	Is the room temperature and/or water temperature too low?	Operate the unit without medication for about 4 minutes, then use the unit.
	Is the medication cup dirty?	After cleaning the medication cup with the detergent, wash off the detergent sufficiently under running water before using the cup.
Nebulisation is unstable.	Is the amount of medication exceeding 150 ml?	Reduce the amount of medication to less than 150 ml. (Refer to Page 10.)
	Are the air volume and the nebulisation rate set to the maximum level when the amount of medication is 150 ml?	Adjust the nebulisation rate. (Refer to Page 11.)

Trouble	Where to Inspect	How to Correct
	① flashes.	The water level in the operating chamber has been lowered. Fill in the water up to the water level of the operating chamber.
	② flashes.	The medication cup cover is open. Securely close the medication cup cover.
	③ flashes.	The fan cover is open. Securely close the fan cover.
	E1 is displayed.	The fan inside the main unit has stopped. Contact the nearest OMRON dealer.

– If the unit does not operate normally after taking the above-mentioned measures, do not touch the internal mechanism and consult the store where you purchased the unit or the nearest OMRON dealer.

Technical data

Product name	: Omron Ultrasonic Nebuliser
Model	: NE-U17 (NE-U17-E)
Power source	: 230 VAC, 50 Hz
Power consumption	: Approx. 80 VA
Fuse	: T2A L250V
Ultrasonic frequency	: Approx. 1.7 MHz
Particle size	: * MMAD 4.4 μm (MMAD=Mass Median Aerodynamic Diameter)
Nebulisation rate	: ** Approx. 0 to 3 ml adjustable
Sound	: ** Less than 45 dB
Air volume	: Maximum of 17 l/min
Amount of cooling water	: Approx. 375 ml
Capacity of medication cup	: Approx. 150 ml (min. 5 ml)
External dimensions	: Approx. 276 (W) x 243 (H) x 226 (D) mm
Weight of the main unit	: Approx. 4.0 kg
Protection class	: Class I
Operating condition	: Continuous
Operating temperature / humidity	: 5°C to 40°C (41°F to 104°F) / 30 to 85% RH
Storage temperature / humidity / air pressure	: -20°C to 60°C (-4°F to 140°F) / 10 to 95% RH / 700 to 1060 hPa
Accessories included	: Inhalation hose M (with a cuff, 70 cm), Mouthpiece set, 2 Medication cups, Power cord, Instruction manual (with warranty card)

Result of cascade impactor measurements for particle size

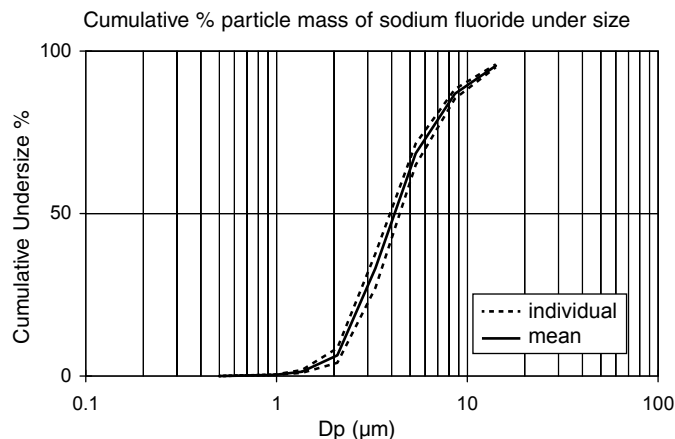

* Independently measured at SolAero Ltd., Canada, Dr. John Dennis, according to EN13544-1:2007.

** Measured by OMRON HEALTHCARE Co., Ltd..

Notes:

- Subject to technical modification without prior notice.
- This OMRON product is produced under the strict quality system of OMRON HEALTHCARE Co., Ltd., Japan.
- The device may not work if the temperature and voltage conditions are different to those defined in the specifications.
- Do not use the device where it may be exposed to flammable gas.
- The Nebulisation rate is measured with saline 0.9% solution at 23°C and can vary with medication and ambient conditions.
- The distribution of particle size is measured with 2.5% NaF solution and can vary with medication and ambient conditions.
- Performance may vary with drugs such as suspensions or high viscosity. See drug supplier's data sheet for further details.
- See web site of OMRON HEALTHCARE EUROPE to update technical information.
URL: www.omron-healthcare.com
- This device fulfils the provisions of the EC directive 93/42/EEC (Medical Device Directive) and the European Standard EN13544-1:2007, Respiratory therapy equipment - Part1: Nebulising systems and their components.

Symbols:

CE 0197

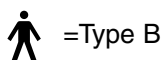

Read the instruction manual carefully

Specifications

Important information regarding Electro Magnetic Compatibility (EMC)

With the increased number of electronic devices such as PC's and mobile (cellular) telephones, medical devices in use may be susceptible to electromagnetic interference from other devices. Electromagnetic interference may result in incorrect operation of the medical device and create a potentially unsafe situation.

Medical devices should also not interfere with other devices.

In order to regulate the requirements for EMC (Electro Magnetic Compatibility) with the aim to prevent unsafe product situations, the EN60601-1-2 standard has been implemented. This standard defines the levels of immunity to electromagnetic interferences as well as maximum levels of electromagnetic emissions for medical devices.

This medical device manufactured by OMRON Healthcare conforms to this EN60601-1-2:2007 standard for both immunity and emissions.

Nevertheless, special precautions need to be observed:

- Do not use mobile (cellular) telephones and other devices, which generate strong electrical or electromagnetic fields, near the medical device. This may result in incorrect operation of the unit and create a potentially unsafe situation. Recommendation is to keep a minimum distance of 7 m. Verify correct operation of the device in case the distance is shorter.

Further documentation in accordance with EN60601-1-2:2007 is available at OMRON Healthcare Europe at the address mentioned in this instruction manual.

Documentation is also available at www.omron-healthcare.com.



Correct Disposal of This Product (Waste Electrical & Electronic Equipment)

This marking shown on the product or its literature, indicates that it should not be disposed of, with other household wastes at the end of its working life. To prevent possible harm to the environment or human health from uncontrolled waste disposal, please separate this from other types of wastes and recycle it responsibly to promote the sustainable reuse of material resources.

Household users should contact either the retailer where they purchased this product, or their local government office, for details of where and how they can take this item for environmentally safe recycling.

Business users should contact their supplier and check the terms and conditions of the purchase contract. This product should not be mixed with other commercial wastes for disposal.

This product does not contain any hazardous substances.

List of Optional Parts

Medication cup
(4997211-8)
Used to transmit the ultrasonic vibration. (If it has any damage or deformation, the unit may not be able to nebulise. Handle this part carefully.)
Material: PP
Packaging unit: 5 cups

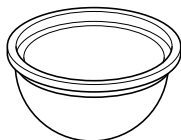

Bacterial filter
(4997213-4)
Used for inhalation such as for tracheal lavage.
Materials: filter; PP, connector; PMP
Packaging unit: 1 filter + 1 adapter

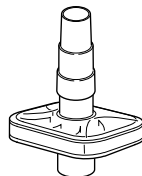

Air filter set
(4997214-2)
Protects the unit from the dust in air.
Materials: case; PP, filter; PS
Packaging unit: 1 set

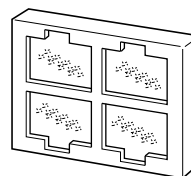

Air filter
(4997215-0)
Material: PS
Packaging unit: 5 filters

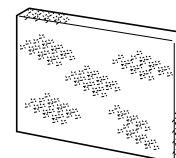

Nebulisation set
(4997216-9)
Used for normal nebulisation.
Materials: medication cup; PP, medication cup holder; ABS, medication cup cover; PMP, packing; silicone
Packaging unit: 1 set



Long time nebulisation set
(4997217-7)
Used for continuous nebulisation. To be used in combination with the supply medication set (4997206-1).
Materials: cover; PMP, cap; silicone
Packaging unit: 1 set

(20/22mm, ISO compatible)

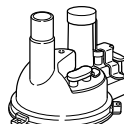

Mouthpiece set
(4997212-6)
Used for inhalation by being held by the mouth.
Material: EVA
Packaging unit: 5 sets

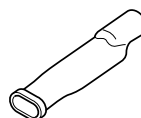

Inhalation mask (L) set
(4997205-3)
Attached with the fixing rubber string. Enables the simultaneous inhalation by mouth and nose.
Material: SEBS
Packaging unit: 3 sets

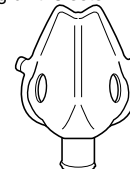

Inhalation mask (S) set
(4997207-0)
Attached with the fixing rubber string. Exclusive for the inhalation by mouth. A size that can be used by an infant.
Material: SEBS
Packaging unit: 3 sets

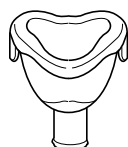

Inhalation hose S (30 cm) with a cuff having the diameter of 20 mm
(4997208-8)
White hose guide tube (cuff) can be removed and installed. Attach it to the hose by rotating clockwise. Cut it to the proper length.
Material: SEBS
Packaging unit: 1 hose

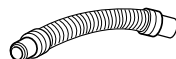

Inhalation hose M (70 cm) with a cuff having the diameter of 20 mm
(4997209-6)
White hose guide tube (cuff) can be removed and installed. Attach it to the hose by rotating clockwise. Cut it to the proper length.
Material: SEBS
Packaging unit: 1 hose

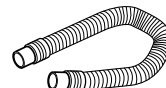

Inhalation hose L (150 cm) with a cuff having the diameter of 20 mm
(4997210-0)
White hose guide tube (cuff) can be removed and installed. Attach it to the hose by rotating clockwise. Cut it to the proper length.
Material: SEBS
Packaging unit: 1 hose

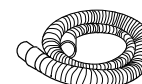

Adapter
(4997218-5)
Material: PMP
Used for connecting 22 mm parts e.g. bacterial filter.

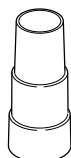



Supply medication set
(4997206-1)
Supplies the medication in order to keep the medication in the medication cup at a certain level. Used for humidifying or inhalation for a long time.
Material: PP
Packaging unit: 1 set



Washer, 5 pcs
(4997285-1)
Materials: silicone



– Materials are indicated by abbreviations.
ABS : Acrylonitrile-butadiene-ethylene resin
EVA : Ethylene vinyl acetic acid resin
PMP : Polymethyle pentane
PP : Polypropylene resin
PS : Polyethylene resin
SEBS : Styrene elastomer

Manufacturer 	OMRON HEALTHCARE Co., Ltd. 24, Yamanouchi Yamanoshita-cho, Ukyo-ku, Kyoto, 615-0084 JAPAN
EU-representative 	OMRON HEALTHCARE EUROPE B.V. Kruisweg 577, 2132 NA Hoofddorp, THE NETHERLANDS www.omron-healthcare.com
Production facility	OMRON MATSUSAKA Co., Ltd. 1855-370, Kubo-cho, Matsusaka-city, Mie-prefecture 515-8503, Japan
Subsidiary	OMRON HEALTHCARE UK LIMITED Opal Drive, Fox Milne Milton Keynes, MK15 0DG U.K.
	OMRON MEDIZINTECHNIK HANDELSGESELLSCHAFT mbH John-Deere-Str. 81a 68163 Mannheim, GERMANY www.omron-medizintechnik.de
	OMRON Santé France SAS 14, rue de Lisbonne 93561 Rosny-sous-Bois Cedex, FRANCE

Made in Japan