

Compact Disc Changer SL-MC70

Operating Instructions

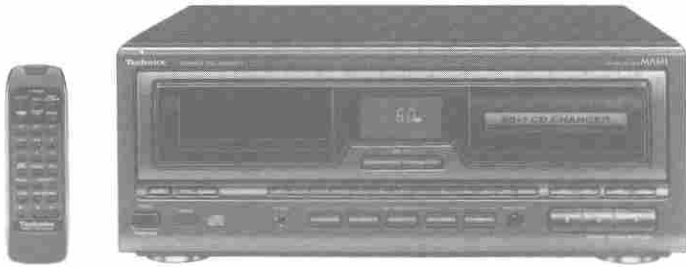

COMPACT
disc
DIGITAL AUDIO



Technics®

Before connecting, operating or adjusting this product, please read these instructions completely. Please save this manual.

Table of contents

Before use

Precautions	4
Front panel controls	5
Connections	6
Concerning the liner note organizer	6
Setting/Removing discs	7

Operations

Basic operations	8
Sequential play	8
To directly access a specific disc	9
To directly access a specific track	9
Single disc play	10
ID scan function	10
Disc grouping play	11
To make groups	11
To name groups	12
To start play	13
Program play	14
Direct programming	16
Random play	17
One disc random play	17
Full random play	17
Repeat function	18
Search function	18
Skip function	19
To skip discs	19
To skip tracks	19

Reference

Concerning compact discs	20
Troubleshooting guide	21
Product service	22
Technical specifications	22

Dear Customer

Thank you for purchasing this product.
For optimum performance and safety, please read these instructions carefully.

The model number and serial number of this product can be found on either the back or the bottom of the unit. Please note them in the space provided below and keep for future reference.

MODEL NUMBER SL-MC70
SERIAL NUMBER _____

User memo:

DATA OF PURCHASE _____
DEALER NAME _____
DEALER ADDRESS _____
TELEPHONE NUMBER _____

Accessories

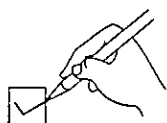

Please check and identify the supplied accessories

AC power supply cord [1] (SJA172)

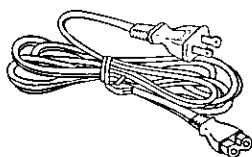

Stereo connection cable [1] (SJP2249-3)

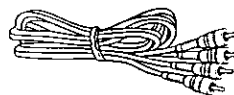

Notebook-like binder [1] [Liner notes organizer] (RFA0622-K1)

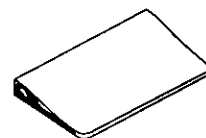

Adhesive number [1] (RQLA0321)

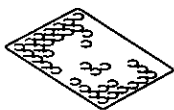

Remote control transmitter [1] (EUR643808)

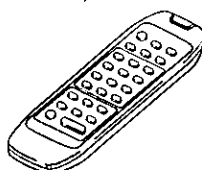

Batteries [2]

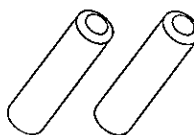

For instructions on preparation and operation of the remote control transmitter, refer to the separate booklet titled "How to use the remote control transmitter".

Use numbers indicated in parentheses when asking for replacement parts.
(Only for U.S.A.)
To order accessories call PASC Accessory Dept. 1-800-211-7262.

THE FOLLOWING PHRASES ARE APPLIED ONLY FOR U.S.A.

CAUTION:

This equipment has been tested and found to comply with the limits for a Class B digital device, pursuant to Part 15 of the FCC Rules. These limits are designed to provide reasonable protection against harmful interference in a residential installation. This equipment generates, uses and can radiate radio frequency energy and, if not installed and used in accordance with the instructions, may cause harmful interference to radio communications. However, there is no guarantee that interference will not occur in a particular installation. If this equipment does cause harmful interference to radio or television reception, which can be determined by turning the equipment off and on, the user is encouraged to try to correct the interference by one of the following measures:

- Reorient or relocate the receiving antenna.
- Increase the separation between the equipment and receiver.
- Connect the equipment into an outlet on a circuit different from that to which the receiver is connected.
- Consult the dealer or an experienced radio/TV technician for help.

Any unauthorized changes or modifications to this equipment would void the user's authority to operate this device.

This device complies with Part 15 of the FCC Rules. Operation is subject to the following two conditions: (1) This device may not cause harmful interference, and (2) this device must accept any interference received, including interference that may cause undesired operation.

CAUTION!

THIS PRODUCT UTILIZES A LASER.
USE OF CONTROLS OR ADJUSTMENTS OR PERFORMANCE OF PROCEDURES OTHER THAN THOSE SPECIFIED HEREIN MAY RESULT IN HAZARDOUS RADIATION EXPOSURE.
DO NOT OPEN COVERS AND DO NOT REPAIR YOURSELF.
REFER SERVICING TO QUALIFIED PERSONNEL.

CAUTION:

TO PREVENT ELECTRIC SHOCK MATCH WIDE BLADE OF PLUG TO WIDE SLOT, FULLY INSERT.

WARNING:

TO REDUCE THE RISK OF FIRE, ELECTRIC SHOCK OR PRODUCT DAMAGE, DO NOT EXPOSE THIS APPLIANCE TO RAIN, SPLASHING, DRIPPING OR MOISTURE.

	CAUTION RISK OF ELECTRIC SHOCK DO NOT OPEN	
---	---	---

CAUTION: TO REDUCE THE RISK OF ELECTRIC SHOCK, DO NOT REMOVE SCREWS. NO USER-SERVICEABLE PARTS INSIDE. REFER SERVICING TO QUALIFIED SERVICE PERSONNEL.



The lightning flash with arrowhead symbol, within an equilateral triangle, is intended to alert the user to the presence of uninsulated "dangerous voltage" within the product's enclosure that may be of sufficient magnitude to constitute a risk of electric shock to persons.



The exclamation point within an equilateral triangle is intended to alert the user to the presence of important operating and maintenance (servicing) instructions in the literature accompanying the appliance.

Precautions

Before using this unit please read these operating instructions carefully. Take special care to follow the warnings indicated on the unit itself as well as the safety suggestions listed below.

Afterwards keep them handy for future reference.

Safety

- 1. Power Source** -- The unit should be connected to power supply only of the type described in the operating instructions or as marked on the unit.
- 2. Polarization** -- If the unit is equipped with a polarized AC power plug (a plug having one blade wider than the other), that plug will fit into the AC outlet only one way. This is a safety feature. If you are unable to insert the plug fully into the outlet, try reversing the plug. If the plug should still fail to fit, contact your electrician to replace your obsolete outlet. Do not defeat the safety purpose of the polarized plug.
- 3. Power Cord Protection** -- AC power supply cords should be routed so that they are not likely to be walked on or pinched by items placed upon or against them. Never take hold of the plug or cord if your hand is wet, and always grasp the plug body when connecting or disconnecting it.
- 4. Nonuse Periods** -- When the unit is not used, turn the power off. When left unused for a long period of time, the unit should be unplugged from the household AC outlet.

Installation

Environment

- 1. Water and Moisture** -- Do not use this unit near water—for example, near a bathtub, washbowl, swimming pool, or the like. Damp basements should also be avoided.
- 2. Condensation** -- Moisture may form on the lens in the following conditions...
 - immediately after a heater has been turned on.
 - in a steamy or very humid room.
 - when the unit is suddenly moved from a cold environment to a warm one.If moisture forms inside this unit, it may not operate properly. To correct this problem, turn on the power and wait about one hour for the moisture to evaporate.
- 3. Heat** -- The unit should be situated away from heat sources such as radiators and the like. It also should not be placed in temperatures less than 5° C (41° F) or greater than 35° C (95° F).

Placement

- 1. Ventilation** -- The unit should be situated so that its location or position does not interfere with its proper ventilation. Allow 10 cm (4") clearance from the rear of the unit.
- 2. Foreign Material** -- Care should be taken so that objects do not fall into and liquids are not spilled into the unit. Do not subject this unit to excessive smoke, dust, mechanical vibration, or shock.
- 3. Magnetism** -- The unit should be situated away from equipment or devices that generate strong magnetic fields.
- 4. Stacking** -- Do not place heavy objects, other than system components, on top of the unit.
- 5. Surface** -- Place the unit on a flat, level surface.

- 6. Carts and Stands** -- The unit should be used only with a cart or stand that is recommended by the manufacturer. The unit and cart combination should be moved with care. Quick stops, excessive force, and uneven surfaces may cause the unit and cart combination to overturn.



- 7. Wall or Ceiling Mounting** -- The unit should not be mounted to a wall or ceiling, unless specified in this operating instructions.

Maintenance

Clean the cabinet, panel and controls with a soft cloth lightly moistened with mild detergent solution.

Do not use any type of abrasive pad, scouring powder or solvent such as alcohol or benzine.

Service

- 1. Damage Requiring Service** -- The unit should be serviced by qualified service personnel when:
 - (a) The AC power supply cord or the plug has been damaged; or
 - (b) Objects have fallen or liquid has been spilled into the unit; or
 - (c) The unit has been exposed to rain; or
 - (d) The unit does not appear to operate normally or exhibits a marked change in performance; or
 - (e) The unit has been dropped, or the enclosure damaged.
- 2. Servicing** -- The user should not attempt to service the unit beyond that described in the operating instructions. All other servicing should be referred to an authorized service personnel. (Only for U.S.A)
Call 1-800-211-7262 for the address of an authorized factory service center.

Cautions on moving this unit

Before moving the changer to another location, be sure to remove all discs from the slots and turn off the changer.

Failure to do so will expose the compact discs and the changer to the risk of severe damage.

CAUTION

The changer mechanism automatically locks when power is turned off, to protect it against damage in transport. Therefore, always press POWER and make sure "OFF" appears on the display before you unplug the changer.

Other cautions

Outside light or noise may sometimes cause the changer to detect a disc when there isn't one. However, the changer always correctly detects the disc when in the play mode no matter what.

Do not leave the front panel open. Infiltrating dust or other matter may lead to damage or malfunctions.

Front panel controls

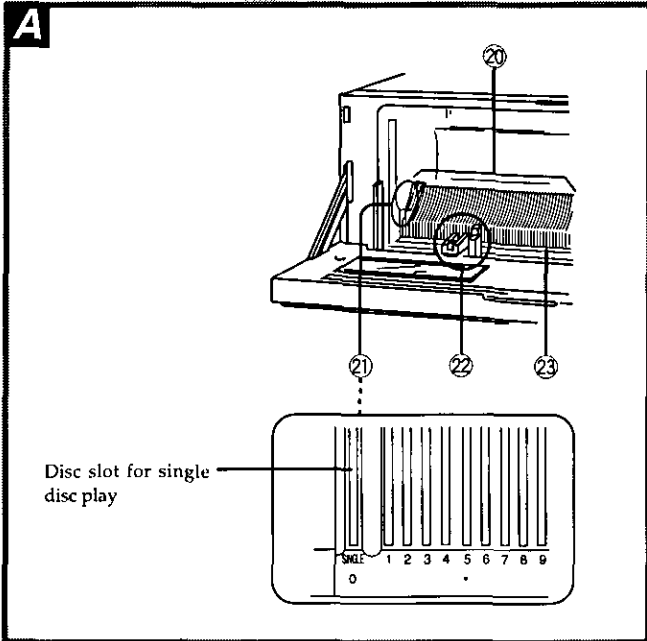
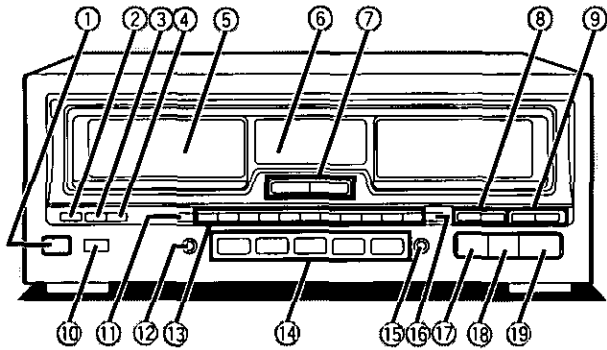

- ① **Power "STANDBY \odot /ON" switch (POWER, STANDBY \odot /ON)**
Press to switch the unit from on to standby mode or vice versa. In standby mode, the unit is still consuming a small amount of power.
- ② **Single disc play button (SINGLE \blacktriangleright)**
- ③ **Direct programming button (DIRECT)**
- ④ **Programming button (PROGRAM)**
- ⑤ **Window**
- ⑥ **Display**
- ⑦ **Disc skip buttons (DISC SKIP -/+)**
- ⑧ **Search buttons (\ll , \gg)**
- ⑨ **Track skip buttons (\lll , \ggg)**
- ⑩ **Remote control signal sensor (SENSOR)**
- ⑪ **Disc selector button (DISC)**
- ⑫ **ID scan button (ID SCAN)**
- ⑬ **Numeric buttons (1—9, 0, ≥ 10)**
- ⑭ **Disc group buttons (DISC GROUPING PLAY, A, B, C, D, E)**
- ⑮ **Group enter button (GROUP ENTER)**
- ⑯ **Disc enter button (DISC ENTER)**
- ⑰ **Stop button (\blacksquare)**
- ⑱ **Pause button (\parallel)**
- ⑲ **Play button (\blacktriangleright)**

Disc slot section **A**

For an explanation on how to open the front panel, see page 7 "How to set discs".



- ⑳ **Disc slots**
- ㉑ **Disc slot for single disc play (SINGLE)**
- ㉒ **Loader carriage**
- ㉓ **Slot numbers**

Connections

Note

- Set the changer on a flat, level surface.
- Before connecting the changer to your audio system, make sure that the power of the changer and all other system components is turned off.

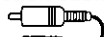
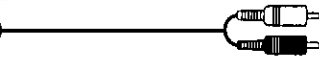
Stereo connection cable

White (L)   
Red (R) 

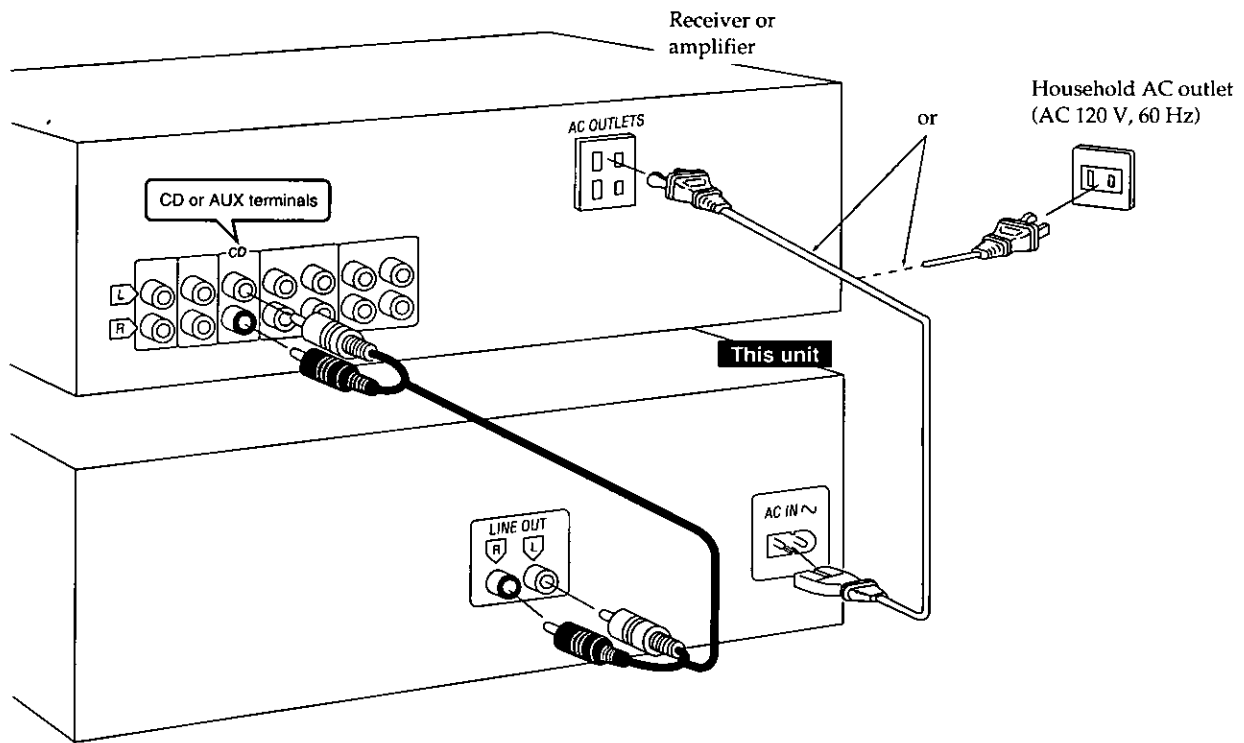

Concerning the liner notes organizer

Your changer comes with a notebook-like binder (liner notes organizer) in which you can keep your CD liners. There are also adhesive numbers for indicating slot numbers in the binder. This is a convenient way to keep track of what disc is in what slot.

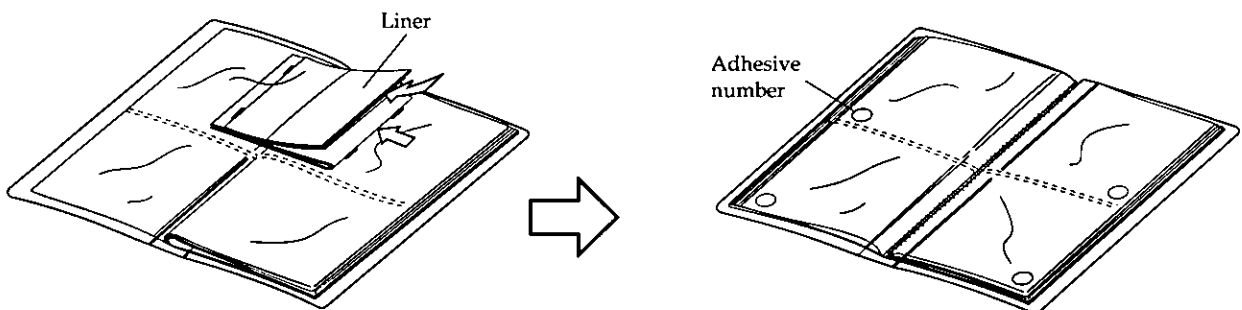

Put two liners back-to-back inside each pocket, as shown above.

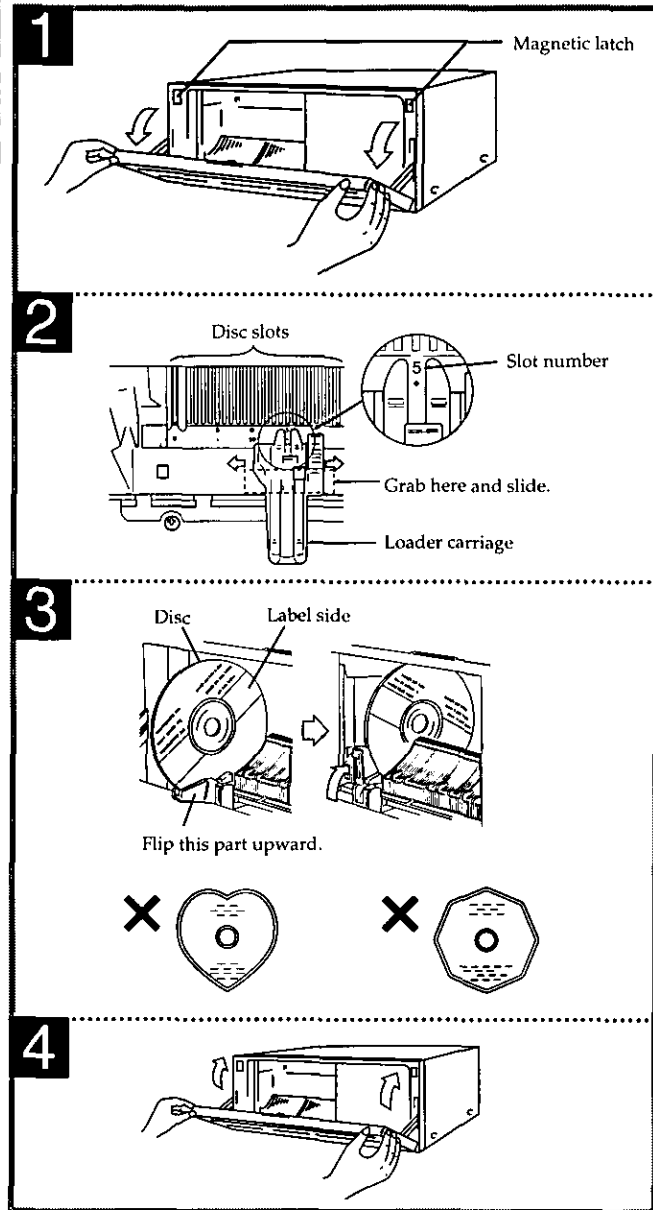
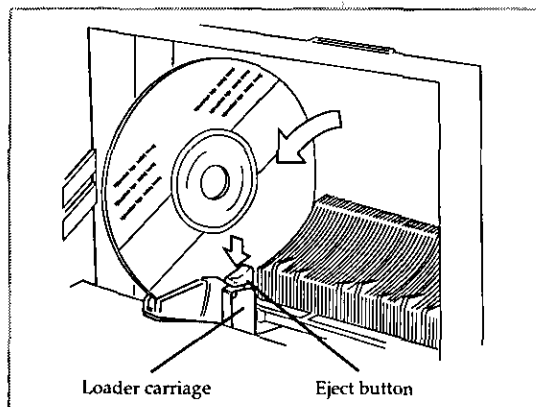
A**B****Setting/Removing discs****How to set discs****A**

- 1** Pulling gently from both ends, open the front panel.

Caution

- Except when setting or removing discs, keep hands out of the changer while open. You could injure yourself if somehow entangled in the internal mechanism.
- Keep cassette tapes away from the magnetic latches.

- 2** Slide the loader carriage to the slot No. where wanting to insert the disc.

Note

Slot No. 0 (SINGLE) is reserved for single disc play. (See page 10.)

- 3** Set the disc on the loader and flip the loader upwards.

Caution

- Do not use 3" (8 cm) discs fitted with expander rings. Expander rings could damage the disc slots.
- Do not use cleaning discs or warped discs. All of these could damage your changer.
- Do not use discs with poorly attached labels or stickers. Adhesive protruding from peeled off stickers can cause the changer to malfunction.
- Do not use irregular shape CDs (heart-shape, octagonal, etc.).
- Do not put anything other than discs in the changer.

- 4** Close gently the front panel.

Note

If you leave the front panel open while a disc is in play, when the disc is over, the changer will stop.

How to remove discs**B**

- 1.** Open the front panel.
- 2.** Slide the loader carriage to the slot you want.
- 3.** Press the eject button on the loader carriage.

Special notes

You can set discs in the slots and remove them too, while playing discs.

- Do not set a disc in the slot of the disc being played (slot flashes). The disc in play is returned to its slot when finished. If two discs somehow jam the slot, one or both could be damaged. When this happens, the message "TAKE OUT" will appear on the display. Remove the disc that doesn't belong in the slot and press the stop button.
- Do not open the CD front panel and press the eject button when "CHECKING DISCS" appears in the display. The CD mechanism will be damaged if the eject button is pressed at this time.
- Sometimes the front panel cannot be opened while a disc is playing. It is a question of time. In such case, wait until you can open it.

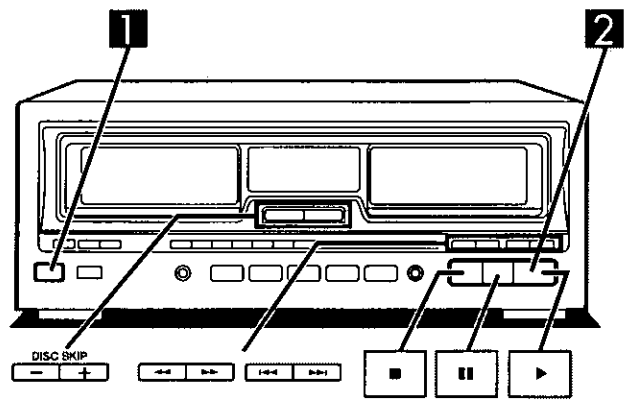

1

2

Disc number in play Play indicator

Track number in play Elapsed play time

A

Current disc

Track Disc Min Sec

10 3 70:31

Track number in play Total playing time

B

Disc Min Sec

1 0:04

Track number in play Elapsed play time

Basic operations

Sequential play

The changer plays all the tracks on all the discs in order and stops automatically when the last track on the last disc finishes playing.

Before starting, load your discs.

1 Press POWER.
The unit will switch on.
Momentarily, the message "CHECKING DISCS" will appear on the display.
When it goes out, the last disc played will be displayed.

2 Press ▶.
Play will begin.

The disc number is the same as the slot number.

To search for the desired position	
To skip tracks	
To skip discs	DISC SKIP

(For detailed information concerning these buttons, please refer to pages 18—19.)

To stop play **A**

Press ■.
The display will show the total number of tracks and the total playing time of the current disc.

The total playing time displayed includes the silent sections between tracks. For this reason, it may be a few seconds longer than the playing time indicated on the disc.
When you open the front panel, the total number of tracks and the total playing time go out.

Press ▶ to re-start play.

Note
It takes roughly 3 seconds from the time you press ■ until the disc is returned to the slot.

To temporarily stop play **B**

Press ||.

Press ▶ to resume play.

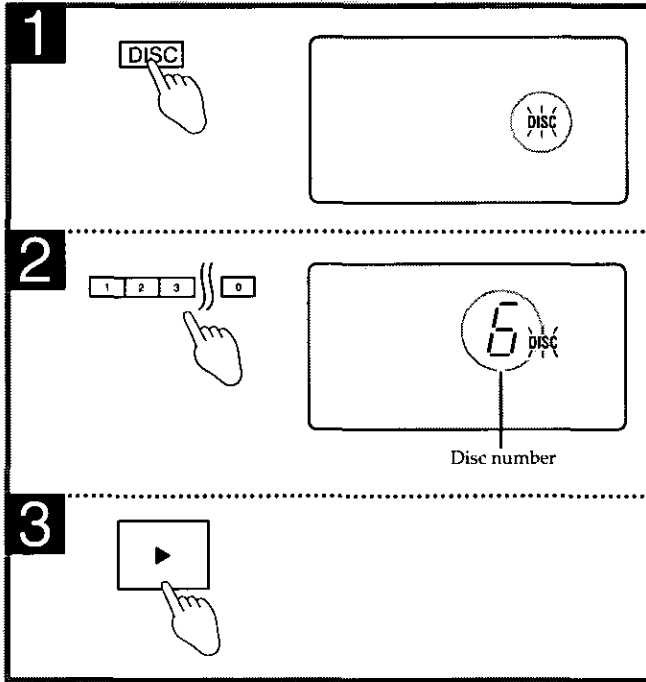
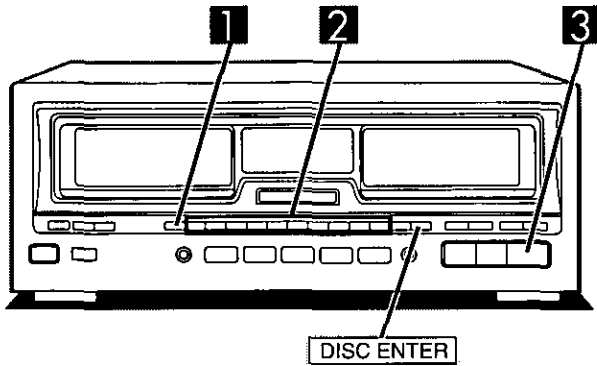
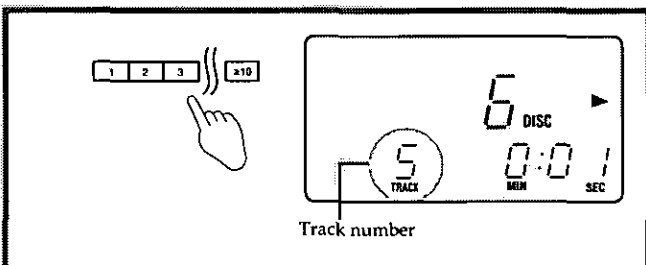
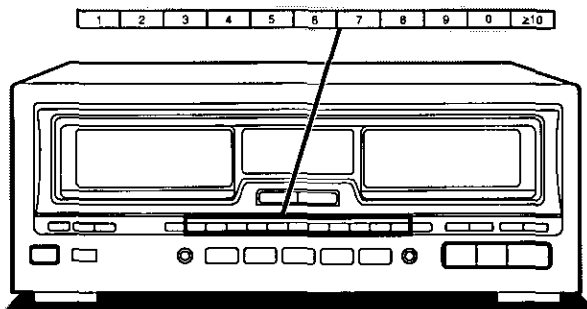
A**B****Basic operations****To directly access a specific disc****A**

- 1** Press DISC.
- 2** [Within 7 seconds]
Select the disc you want with the numeric buttons.

To select a disc from 1 to 9

For example: "6"

6

To select a disc from 10 to 60

For example: "19"

1 → 9

Push the button within 7 seconds each other.

Note

When selecting discs, the ≥10 button does not respond to touch.

- 3** [Within 7 seconds]
Press ►.

The changer will start playing the selected disc from the first track.

For your reference

- If you press DISC ENTER instead of ► to select a disc, the disc number will be displayed but play will not start automatically.
- When in the stop mode, if you select an empty slot, the message "NO DISC" will appear on the display.
- While a disc is playing, if you select an empty slot, the changer will automatically play the next disc available.
- If you select "0", the changer will switch to the single disc play mode.

To directly access a specific track**B**

After selecting a disc, select a track with the numeric buttons.

Press the numeric button(s) to select the track.

To select a track from 1 to 9

For example: "6"

6

To select a two-digit track number 10 or higher

For example: "19"

≥10 → 1 → 9

Push the button within 7 seconds each other.

Play will begin from the selected track.

A

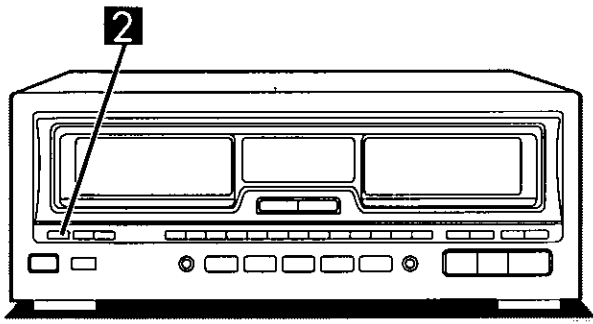

1

Slot number

Loader carriage

2

SINGLE ▶

TRACK MIN SEC

DISC SINGLE

Single disc play A

Single disc play is convenient when wanting to playback a specific disc right away, without going through the usual selection procedure, for example, to listen to a disc you just bought.

1 **Open the front panel, and set the disc in the slot No. 0.**
Face the label to the right and flip the loader upwards to set the disc.

2 **Close the front panel and press SINGLE ▶.**

The changer plays all the tracks in order and stops automatically when the last track finishes playing.

To cancel single disc play mode

- Select another disc with the numeric buttons.
- Skip to another disc with DISK SKIP -/+.
- Select a group.

ID scan function B

This function is convenient to use when searching for a desired track.

The function will search from the beginning of the track for a loud section, and will play 10 seconds of the track centering around that point.

The order of scanning is the same as for play mode.

1 **Press ID SCAN.**
ID scan will start.

2 [When the desired track has been found]

Press ▶.
The changer will play the track from the beginning.

To cancel ID scan

Press ID SCAN while this function is in operation.
The "ID SCAN" indicator will go out.

The changer will continue to play from the track being played.

B

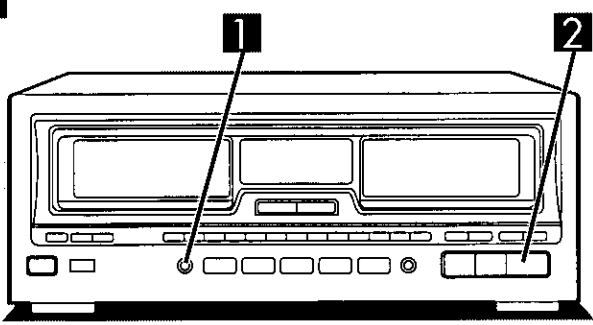

1

ID SCAN

TRACK MIN SEC

DISC ID SCAN

2

Disc grouping play

With disc grouping play, you can register discs into any of the five available groups (A-E) and then play back only the discs in a specific group.

- The same disc can be registered in as many groups as you like.
- Each group can hold up to 60 discs.
- You can name each group.

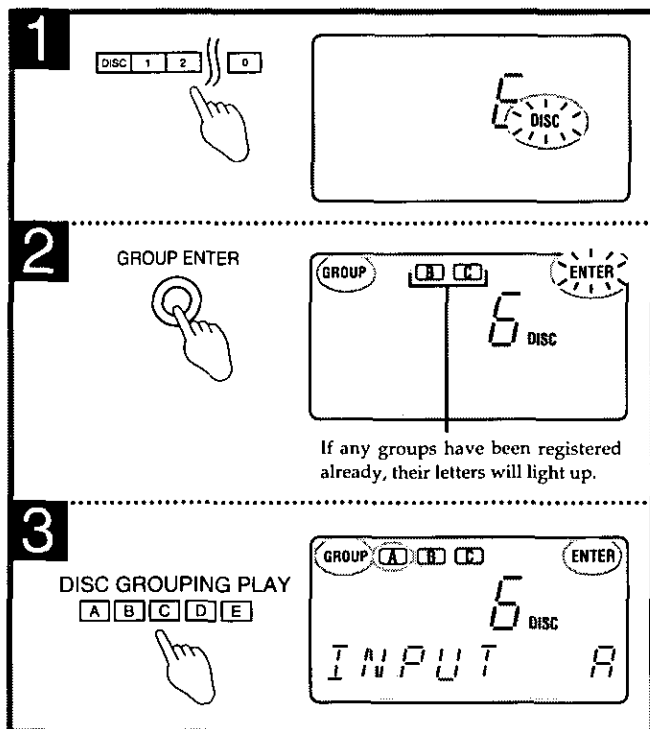
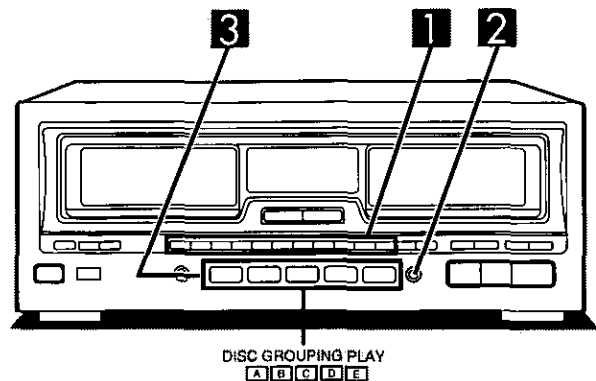

To make groups

- 1 [During sequential play or while it is on stop]
Select a disc.

To select a disc from 1 to 9

For example: "6"

DISC → 6

To select discs from 10 to 60

For example: "19"

DISC → 1 → 9

Push the button within 7 seconds each other.

Note

You cannot select slot No. 0.

For your reference

You can select discs with the DISC SKIP - and + buttons.

- 2 [Within 7 seconds]
Press GROUP ENTER.
- 3 [Within 7 seconds]
Press the DISC GROUPING PLAY button you want.
(This input the disc in the group.)

For example: To input disc in group A.

Press **A**.

- 4 **Repeat steps 1, 2 and 3 until you have completed all items.**

To cancel disc grouping play mode

[In the stop mode]

Press the DISC GROUPING PLAY button indicated on the display.

(The group indication on the display will go out.)

For your reference

The group contents will remain stored in memory even after the unit is switched off.

However, if the power cord is unplugged or the power supply is otherwise interrupted for an extended length of time, the contents will be erased from memory.

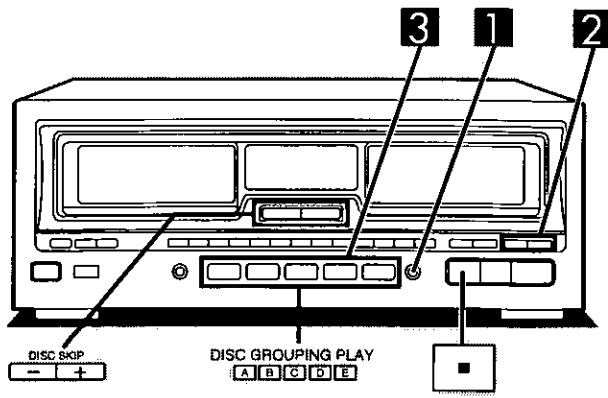

1 **GROUP ENTER**

If any groups have been registered already, their letters will light up.

2

3 **DISC GROUPING PLAY**

Disc grouping play

To name groups

You can name your groups. The changer has several preset names to choose from.

- 1** [During sequential play or while it is on stop]
Press GROUP ENTER.
- 2** [Within 7 seconds]
Select the name you want with <<< and >>>.
Names change in rotation as shown below, every time you press <<< or >>>.

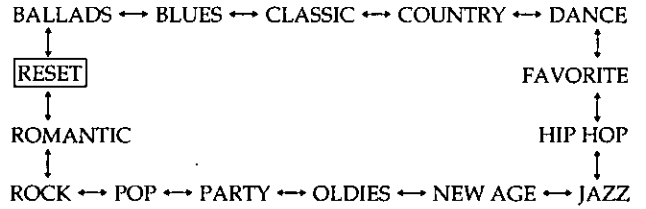

- 3** [Within 7 seconds]
Press the DISC GROUPING PLAY button for the group you want to name.

For example: To name group A
Press [A].

- 4** **Repeat steps 1, 2 and 3 to name other groups.**

To cancel names

Select "RESET" in step 2 and then the name of the group you want to cancel in step 3. Thereafter, the group will appear as "GROUP ... (A,B,C,D or E)".

To check what discs are in what groups

1. [During sequential play or while it is on stop]
Press the DISC GROUPING PLAY button (A, B, C, D or E) you want and then press ■.
2. Press either DISC SKIP (- or +).
Every time you press DISC SKIP, the next disc number in order is displayed.

Note

After checking, if you press the button of a group that is lit on the display, the disc grouping mode disengages.

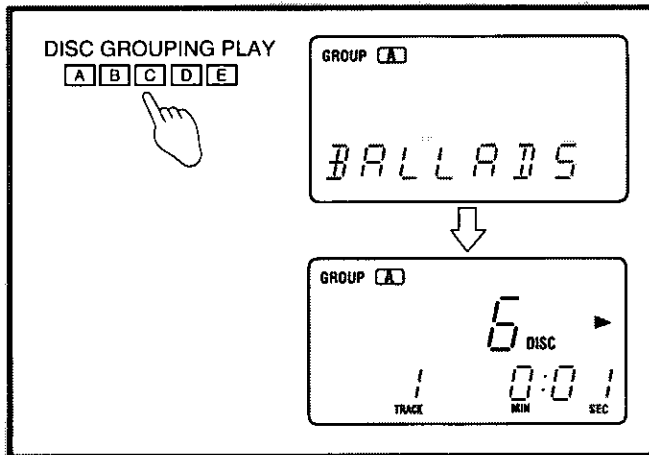
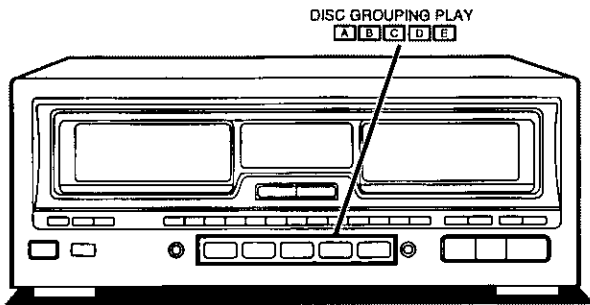
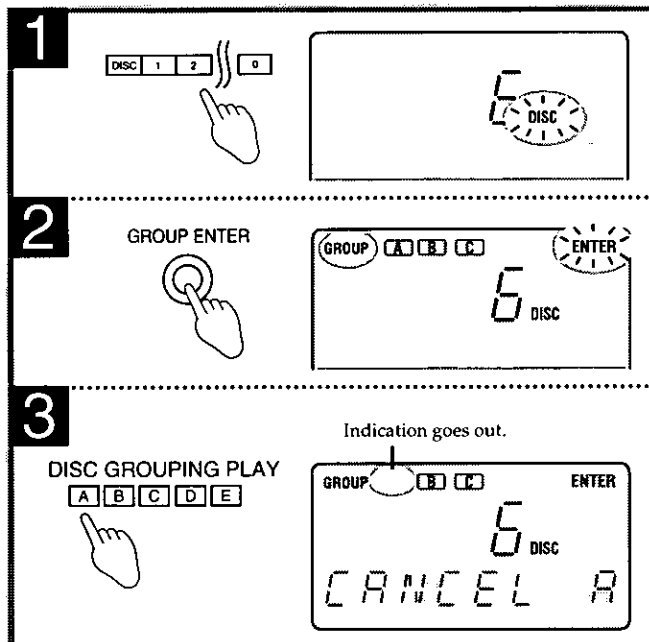
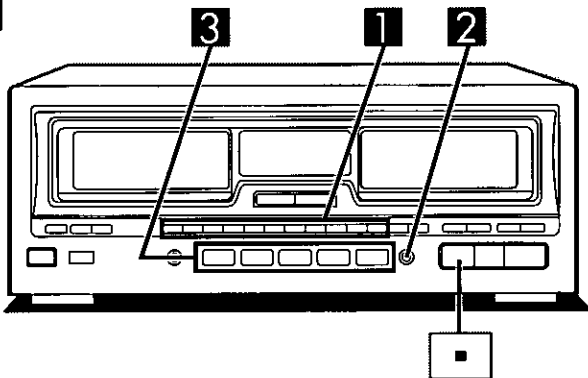
A**B****Disc grouping play****To start play****A**

Unless otherwise specified, the changer selects sequential play.

[During sequential play or while it is on stop]

Press the DISC GROUPING PLAY button of the group you want.

For example: To hear group A

Press **[A]**.

Note

- Unnamed groups will be displayed as "GROUP A, B, C ..." and so forth.
- If you press the group button of a group which has no discs registered in it, the message "NO INPUT" will appear on the display.

To cancel discs from groups**1**

Select a disc.

After pressing the DISC button, press the number of the disc that you want to cancel.

2

[Within 7 seconds]

Press GROUP ENTER.

3

[Within 7 seconds]

Press the DISC GROUPING PLAY button you want.

For example: To cancel disc No. 7 from group A.

Press **[A]**.

If the disc is registered in more than one group, you can cancel it from all groups in a single operation by pressing **[■]** in step 3 (in the stop mode).

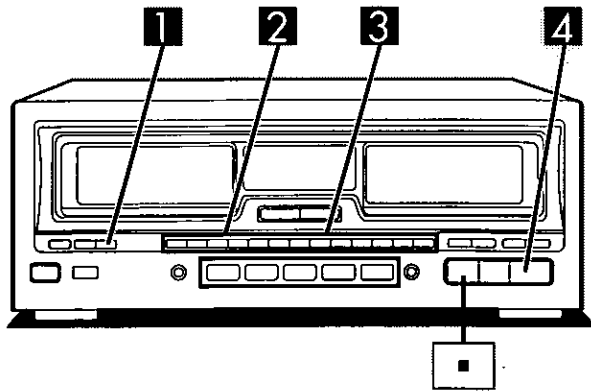

1

2 Specified disc number

3 Specified track number Program order

4

A

Program play

Program play lets you playback your favorite tracks in the sequence you want to hear them. The program can hold up to 32 steps.

1 [In the stop mode]
Press **PROGRAM**.

2 Select the disc(s) you want with the numeric buttons.

For example: To select disc 3.

[DISC] → **[3]** → **[DISC ENTER]**

The "ALL" indication shows that all the tracks on the disc are selected.

To program by means of disc numbers only, repeat the above operation. (The count will increase by one for each operation.)

You can select slot No. 0.

3 Press the numeric button(s) to specify the track.

For example: To select track No. 20

[≥10] → **[2]** → **[0]**

To program another track from the same disc, simply specify the track No.

Repeat steps 2 and 3 until you have completed all entries.

If you attempt a 33rd selection, the "PGM FULL" indication will be displayed.

If you enter non-existing disc(s) or track(s), the corresponding indicator illuminates and the entry is included in the count. In the play mode, the changer will cancel the non-existing entry.

4 Press **▶** to start play.

To enter additional selections during play, repeat steps 2 and 3.

To clear all programmed contents

[In the stop mode]

Press .

Program play

To check programmed contents **A**

(only available from the remote control)

Press **RECALL**.

Each time you press **RECALL**, the display shows the programmed disc and track number in the sequence you have entered.

To clear a single item from the program **B**

(only available from the remote control)

[In the stop mode]

Press **CLEAR**.

Each time you press **CLEAR**, you will cancel the last entry in the order you have entered all selections.

To clear an entry in the middle of the program sequence, press **RECALL** repeatedly until the display shows the selection to be cleared, and then press **CLEAR** within three seconds after that.

To quit the program mode **C**

[In the stop mode]

Press **PROGRAM**.

The changer will return to the sequential play mode.

The programmed contents will remain stored in memory until they are cleared, even after the program mode is canceled.

Therefore, after program, it is possible to cancel the program mode and use another play mode and then hear the same program again at a later time.

In addition, if discs are changed, the program will be played using the new discs. If non-existing entries are found at this time, the changer will cancel them.

For your reference

The program will remain stored in memory even after the unit is switched off.

However, if the power cord is unplugged or the power supply is otherwise interrupted for an extended length of time, the contents will be erased from memory.

Special note on recording programs

The changer needs time to change the discs and find the tracks.

Consequently, it will take the changer slightly longer than the total track time to record everything. Exactly how much longer it will be will depend on the contents of the program.

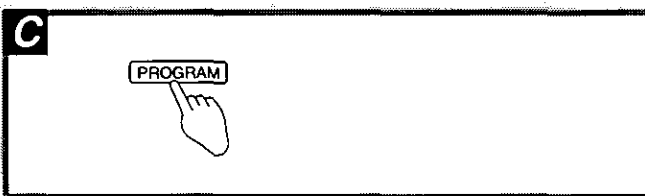
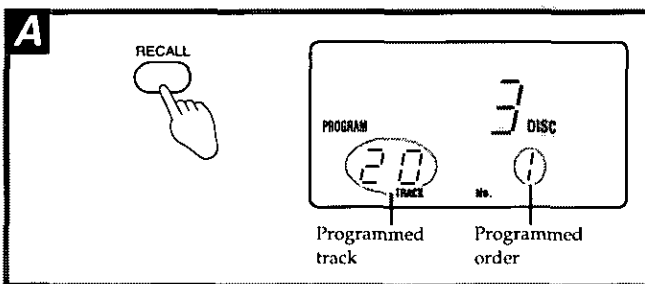
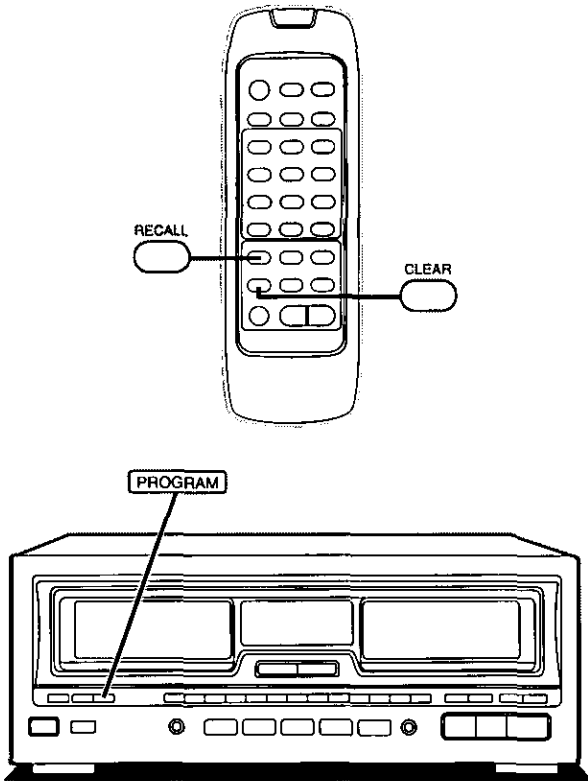

Direct programming

If, while listening to a certain track, you decide that you want to add that track to your program, you can with direct programming.

[While the track you want to program is playing]

Press DIRECT.

The current track will be added to the tail end of the program. When you make a program as explained under "Program play", and then perform the above procedure without clearing the program first, the selected track is added to the end of the program.

Note

- You cannot add to the program if already full, that is, if already 32 selections have been programmed. If you press DIRECT in such case, the message "PGM FULL" will be displayed. Therefore, direct programming is possible only when 31 or less tracks have been programmed.
- During program play, the DIRECT button does not respond to touch.

To listen to programmed tracks **A**

[In the stop mode]

Press PROGRAM and check "PROGRAM" appears on the display, then press ►.

The program will start from the first track.

To check programmed contents.

(See page 15.)

To clear a single item from the program.

(See page 15.)

To clear all programmed contents.

[In the stop mode]

Press ■.

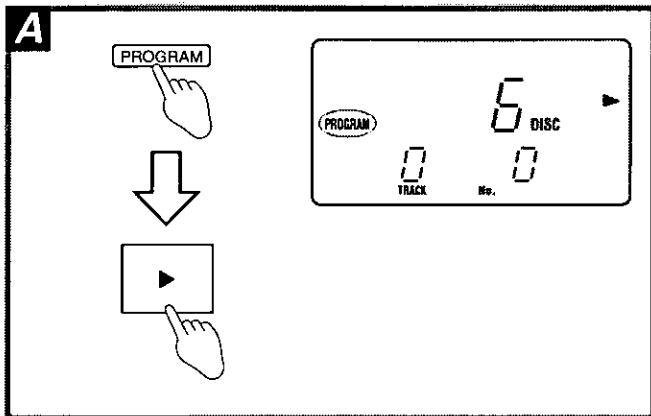
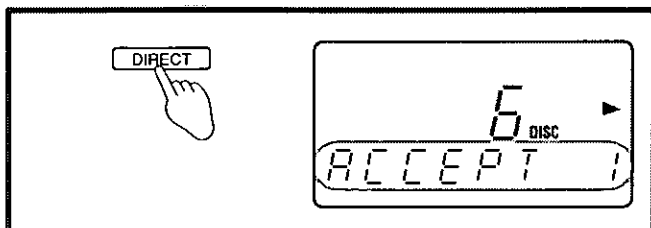
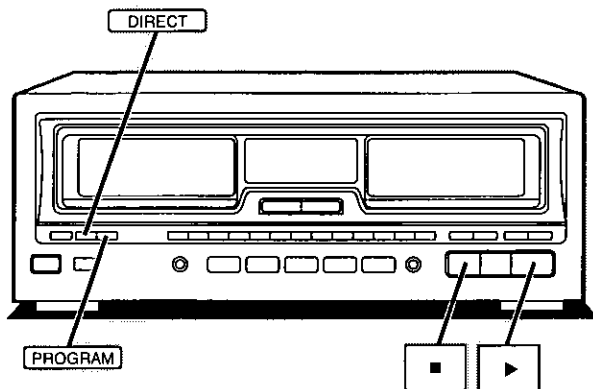

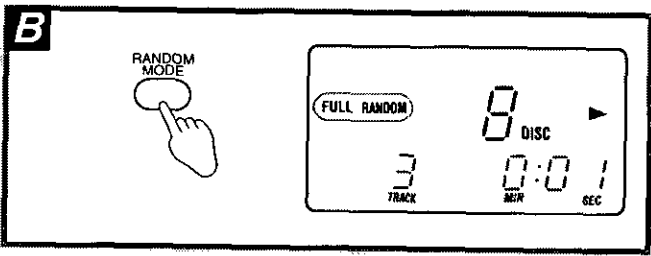
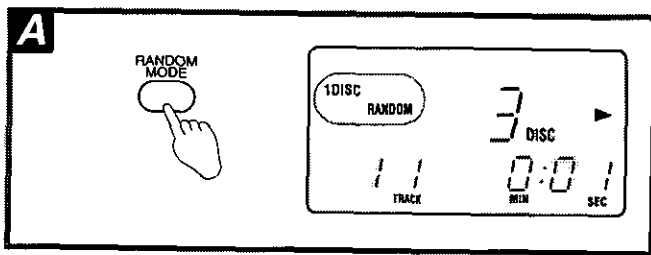
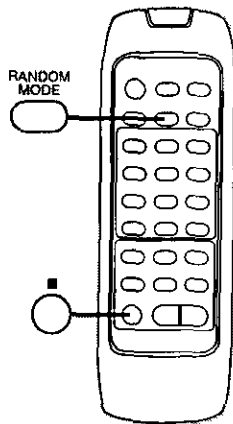

Random play

(Only available from the remote control)

The tracks will be played in random order. There are two types of random play as described below.

One disc random play A

The changer will play all tracks on the current disc in random order. Then, it will choose a new disc randomly, excluding the discs already played, and play all tracks on that disc in random order.

[In the stop or play mode]

Press RANDOM MODE so that the "1 DISC RANDOM" indicator illuminates.

Each time the button is pressed, the display will change in the following order: 1 DISC RANDOM → FULL RANDOM → (off).

The changer will stop automatically when all the tracks on all discs have been played once.

In the single disc play mode

Only tracks from the disc in slot No.0 are played, though played in random order.

Every time you press RANDOM MODE, the display switches between OFF and "RANDOM".

In the disc grouping play mode.

The changer randomly plays back tracks only from discs included in the selected group.

Full random play B

The changer will play tracks from all of the discs at random. However, it may choose the same track twice. In a single pass, the changer can play up to 250 tracks.

[In the stop or play mode]

Press RANDOM MODE so that the "FULL RANDOM" indicator illuminates.

Each time the button is pressed, the display will change in the following order: 1 DISC RANDOM → FULL RANDOM → (off).

Once the changer has played the maximum 250 tracks, it stops automatically.

Note

The disc in slot No.0 will not be played.

In the disc grouping play mode.

The changer selects tracks randomly from all discs in the group but not from other groups.

To cancel random play mode

Press ■.

The "1 DISC (or FULL) RANDOM" indicator will go out.

A

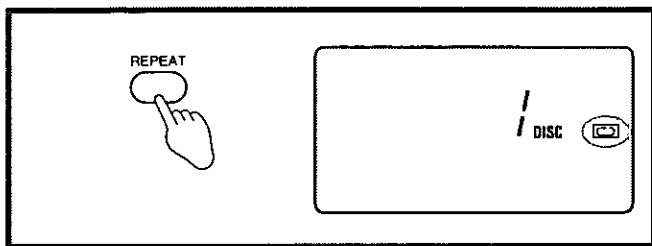
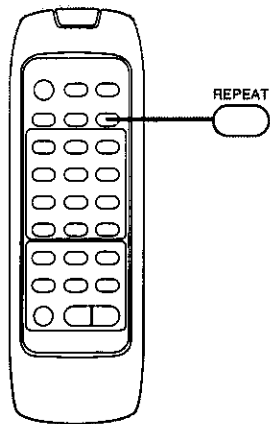

B

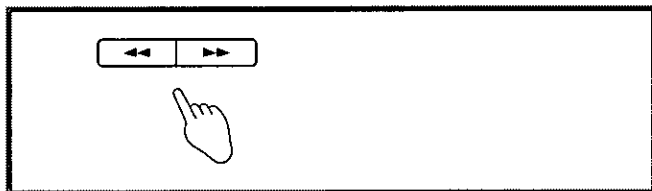
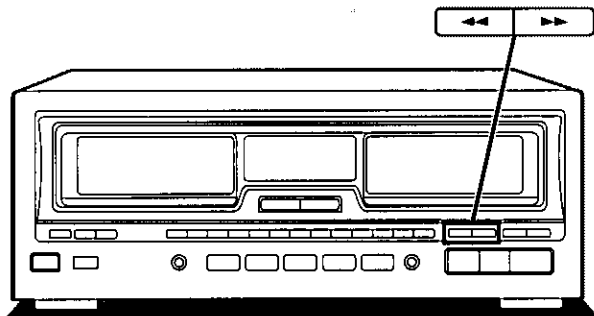

Repeat function 

(Only available from the remote control.)

Play will continue endlessly in accordance with the specific play mode selected.

[Before or during play]

Press REPEAT.

In the sequential play mode

All tracks of all discs will be played repeatedly.

In the single disc play mode

The changer will repeatedly play all tracks on the disc in slot No. 0.

In the program play mode

The changer plays only the programmed selections in the programmed sequence repeatedly.

In the one disc random play mode

When the changer has played all the tracks on the current disc in random order. Then, it will choose a new disc randomly, excluding the discs already played, and play continuously. The sequence differs each time.

In the full random play mode

Once the changer has played the maximum 250 tracks, it will select a new random sequence and will continue playing.

To repeat the same track over and over

1. Select the desired track using the program play procedure on page 14.
2. Press REPEAT to display "⏮".
3. Press ▶.

To cancel repeat mode

Press REPEAT again.

The "⏮" indicator will go out.

Search function 

You can search rapidly forward or backward on the disc for specific sections.

[In the play or pause mode]

Press and hold ◀◀ or ▶▶ .

◀◀ : You can search backward.

▶▶ : You can search forward.

Release the button when you reach the desired point.

The changer will return to the previous mode (play or pause).

In the sequential/disc grouping play mode

When the changer finishes searching the current disc, it starts searching the next one.

In the single disc play mode

You can search forward or backward only within the current disc.

In the program/random play mode

You can search forward or backward only within the current track.

Skip function

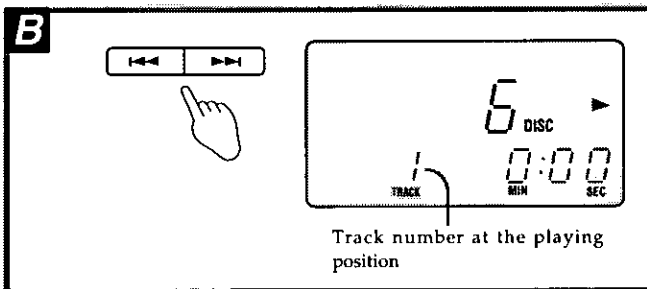
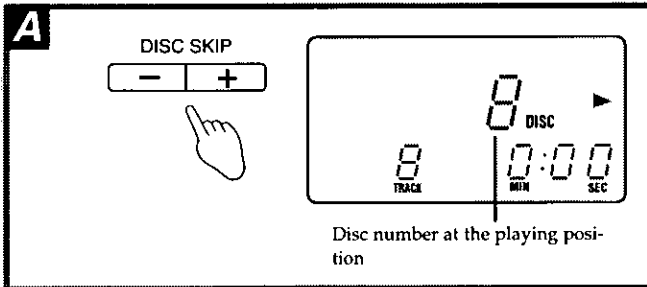
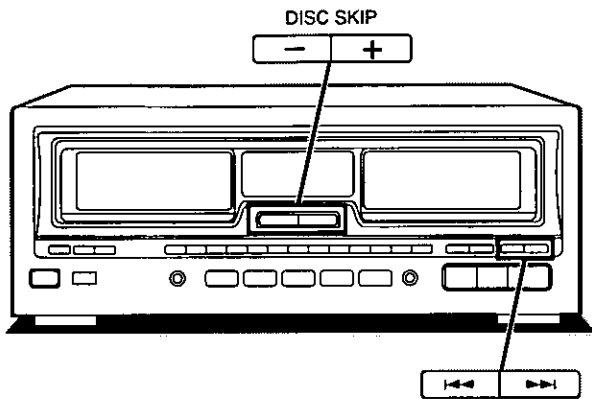

To skip discs

A

Use this function to skip discs when selecting a disc which you wish to listen to.

You can use this function in stop, sequential play, one disc random play and disc grouping play modes.

Press either DISC SKIP (- or +) until you reach the desired disc.

- : Skips backwards to the preceding disc.
- +: Skips forward to next disc.

Note

- The changer skips over empty slots.
- This function does not work in the full disc random play mode or during program play.
- If you attempt to use this function during single disc play, the changer will cancel single disc play.

To skip tracks

B

Use this function to skip tracks when selecting a track which you wish to listen to.

Press either ⏮ or ⏭ until you reach the desired track.

- ⏮: You can skip backward.
- ⏭: You can skip forward.

In the sequential/single disc/disc grouping/program play mode

In the program play mode, you can skip from one track to another in the programmed sequence.

In any other mode, you can skip forward and backward within the current disc only.

- ⏮: You can skip to the beginning of the track being played. If you press this button again quickly, you can skip to the beginning of the previous track.
- ⏭: You can skip as many tracks as the number of times you press the button.

In the random play mode

- ⏮: You can skip to the beginning of the current track.
- ⏭: You can skip to the beginning of a next track in the random order the changer has selected.

You can also skip tracks when the changer is in the stop mode or pause mode.

Concerning compact discs

With this changer, you can only play compact discs having this mark. However, do not use irregular shape CDs (heart-shape, octagonal, etc.). CDs of the sort can damage the unit. (A)

COMPACT
disc
DIGITAL AUDIO

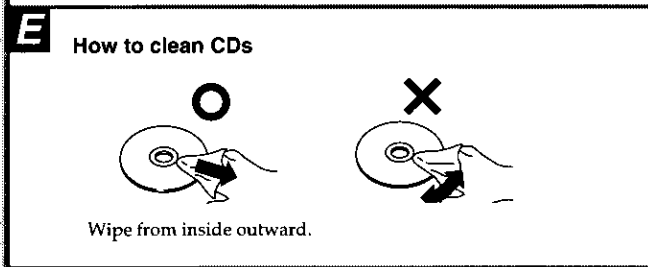
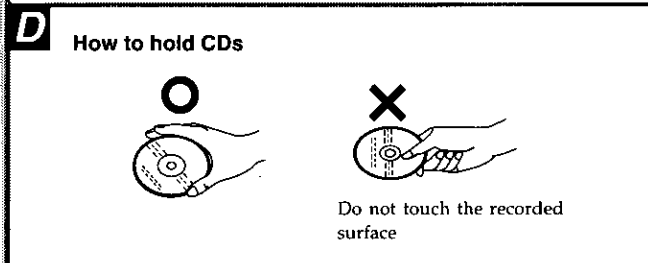
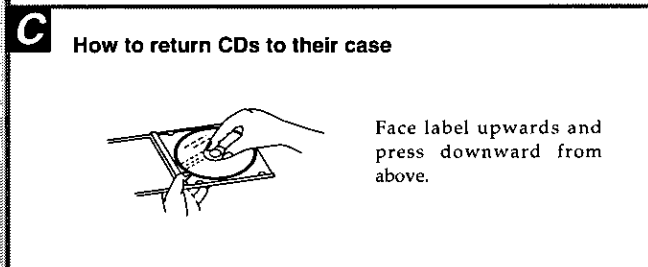
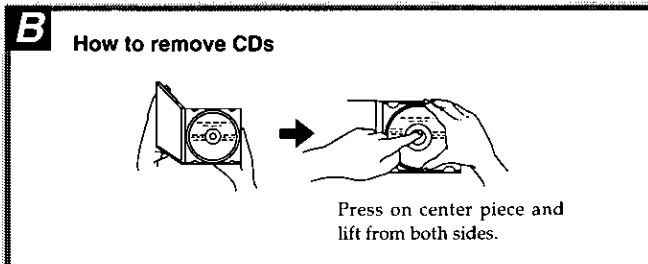
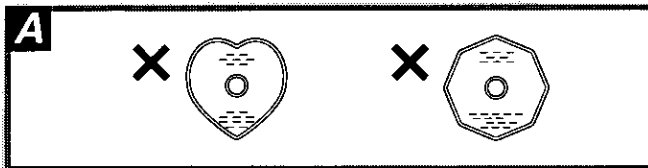

Handling precautions

Handle CDs as shown on the left (B-E).

- If you are taking the disc from a cold to a warm environment, moisture may form on the disc. Wipe this off with a soft, dry, lint-free cloth before using the disc.
- Do not write on the label side with a ball-point pen or other writing instrument.
- Do not use record cleaning sprays, benzine, thinner, static electricity prevention liquids or any other solvent.
- Do not use discs with poorly attached labels or stickers. Adhesive protruding from peeled off stickers can cause the changer to malfunction.

Storage precautions

Be sure to store discs in their cases to protect them from dust, scratches, and warping.

Do not place or store discs in the following places:

- Locations exposed to direct sunlight
- Humid or dusty locations
- Locations directly exposed to a heat vent or heating appliance
- In the glove compartment or on the rear deck of an automobile

Troubleshooting guide

Before requesting service for this unit, check the chart below for a possible cause of the problem you are experiencing. Some simple checks or a minor adjustment on your part may eliminate the problem and restore proper operation.

If you are in doubt about some of the check points, or if the remedies indicated in the chart do not solve the problem, refer to the directory of authorized service centers (enclosed with this unit) to locate a convenient service center, or consult your dealer for instructions.

(In U.S.A. consult PASC Authorized Servicenters for detailed instructions or call 1-800-211-7262 for the address of an authorized factory servicenter.)

Reference pages indicated in black circles. (For example: ⑦)

Problem	Probable cause(s)	Suggested remedy
Changer will not play.	A disc(s) or other foreign object(s) has fallen inside the changer.	• Open the front panel, and then remove the object.
	Moisture has collected in the changer.	• Allow the changer to dry out for about one hour before using it.
The disc in the changer does not play.	The disc label is facing left.	• Set the disc with the label facing right. (⑦)
	The disc is dirty.	• Wipe the disc with a soft cloth. (⑳)
	The disc is scratched.	• Replace the disc with a new one.
	The disc is warped.	
	The disc is not within specified standards.	
Play stops before changing to the next disc.	The front panel is open.	• Close the panel.
A certain music passage can't be played correctly.	The disc is dirty.	• Wipe the disc with a soft cloth. (⑳)
	The disc is scratched.	• Replace the disc with a new one.
There is noise from the tuner or disturbance on the TV screen.	Caused by high-frequency signals from this changer.	• Use the changer further away from the tuner or TV. • If the tuner or TV's antenna is the indoor type, use an outdoor one.
The error message "NO PGM" appears on the display, when program play is started.	Play was started without a track being programmed.	• Program a track. (㉑)
The error message "ERROR" appears on the display, and the changer stops operating.	The mechanism of the changer has been improperly adjusted.	• Turn the unit off and then back on again.
The error message "F-26" appears on the display and the changer stops operating.	The servo LSI has malfunctioned.	• Unplug the changer from its outlet, replug it in and turn the changer ON again.
The error message "TAKE OUT" appears on the display and the changer stops operating.	A disc has been put in the slot of the disc in play.	• Remove the disc whose number is displayed and press the stop button.
	Because of light or noise, the changer has detected a disc in the slot of the disc being played, even through it is empty.	• Check whether there is a disc in the displayed slot. With the front panel close, hold down ■ for at least 4 seconds.

Product service

Do not attempt to remove the cover(s) or repair the unit yourself. Refer servicing to qualified personnel only.

Product information

For product service, product information or assistance in product operation, refer to the servicenter directory.

When getting service

Before bringing in your changer for service, be sure to remove all discs first.

If the disc in play doesn't return to its slot when you press ■, hold the button down for about 4 seconds. The disc should return to the slot.

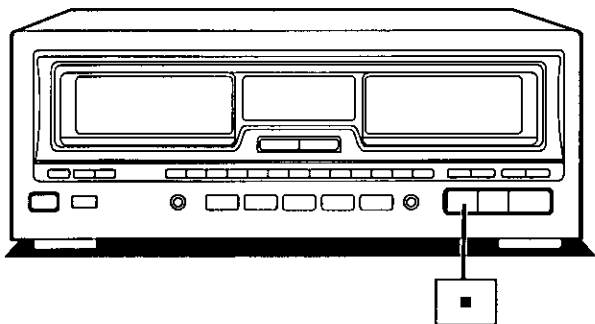

Technical specifications

■ AUDIO

No. of channels	2 (left and right, stereo)
Frequency response	2—20,000 Hz, ± 1 dB
Output voltage	2 V (at 0 dB)
Dynamic range	92 dB
S/N	100 dB
Total harmonic distortion	0.007% (1 kHz, 0 dB)
Wow and flutter	Below measurable limit
DA converter	MASH (1 bit)
Output impedance	Approx. 1 k Ω
Load impedance	More than 10 k Ω

■ PICKUP

Wavelength	780 nm
------------	--------

■ GENERAL

Power supply	AC 120 V, 60 Hz
Power consumption	11 W
Dimensions (W×H×D)	430×170×387 mm (16-15/16"×6-11/16"×15-1/4")
Weight	6.3 kg (13.9 lb.)

Note: Specifications are subject to change without notice. Weight and dimensions are approximate.

MASH is a trademark of NTT.

Disc index

If should be easier for you to remember what disc is in what slot and the group(s) it's in if you record everything in this table.

No.	GROUP					DISC NAME
0	SINGLE					
1	A	B	C	D	E	
2	A	B	C	D	E	
3	A	B	C	D	E	
4	A	B	C	D	E	
5	A	B	C	D	E	
6	A	B	C	D	E	
7	A	B	C	D	E	
8	A	B	C	D	E	
9	A	B	C	D	E	
10	A	B	C	D	E	
11	A	B	C	D	E	
12	A	B	C	D	E	
13	A	B	C	D	E	
14	A	B	C	D	E	
15	A	B	C	D	E	
16	A	B	C	D	E	
17	A	B	C	D	E	
18	A	B	C	D	E	
19	A	B	C	D	E	
20	A	B	C	D	E	
21	A	B	C	D	E	
22	A	B	C	D	E	
23	A	B	C	D	E	
24	A	B	C	D	E	
25	A	B	C	D	E	
26	A	B	C	D	E	
27	A	B	C	D	E	
28	A	B	C	D	E	
29	A	B	C	D	E	
30	A	B	C	D	E	

No.	GROUP					DISC NAME
31	A	B	C	D	E	
32	A	B	C	D	E	
33	A	B	C	D	E	
34	A	B	C	D	E	
35	A	B	C	D	E	
36	A	B	C	D	E	
37	A	B	C	D	E	
38	A	B	C	D	E	
39	A	B	C	D	E	
40	A	B	C	D	E	
41	A	B	C	D	E	
42	A	B	C	D	E	
43	A	B	C	D	E	
44	A	B	C	D	E	
45	A	B	C	D	E	
46	A	B	C	D	E	
47	A	B	C	D	E	
48	A	B	C	D	E	
49	A	B	C	D	E	
50	A	B	C	D	E	
51	A	B	C	D	E	
52	A	B	C	D	E	
53	A	B	C	D	E	
54	A	B	C	D	E	
55	A	B	C	D	E	
56	A	B	C	D	E	
57	A	B	C	D	E	
58	A	B	C	D	E	
59	A	B	C	D	E	
60	A	B	C	D	E	

Write your group names in here.

GROUP	GROUP NAME
A	
B	
C	
D	
E	

Reference

**Panasonic Consumer Electronics
Company, Division of Matsushita
Electric Corporation of America**
One Panasonic Way Secaucus,
New Jersey 07094

**Panasonic Sales Company,
Division of Matsushita Electric of
Puerto Rico, Inc. ("PSC")**
Ave. 65 de Infantería. Km. 9.5
San Gabriel Industrial Park, Carolina,
Puerto Rico 00985



RQT4488-P

H1297N0