

**Multi-CD control High power cassette player with
FM/AM tuner**

Operation Manual

KEH-P4025

Pioneer

English

Español

Português (B)

中文

العربية

Thank you for buying this Pioneer product.

Please read through these operating instructions so you will know how to operate your model properly. *After you have finished reading the instructions, put them away in a safe place for future reference.*

Before You Start

- About this manual **2**
- Precautions **2**
- What's what **3**
- Optional remote control **4**
- Protecting your unit from theft **5**
 - Removing the front panel **5**
 - Attaching the front panel **5**

Power ON/OFF

- Turning the unit on **6**
- Selecting a source **6**
- Turning the unit off **6**

Tuner

- Listening to the radio **7**
- Storing and recalling broadcast frequencies **8**
- Tuning in strong signals **8**
- Storing the strongest broadcast frequencies **8**

Cassette Player

- Playing a tape **9**
- Repeating play **10**
- Skipping blank tape sections **10**
- Radio intercept **10**

Multi-CD Player

- Playing a CD **10**
- 50-disc multi-CD player **11**
- Repeating play **11**
- Playing tracks in a random order **12**
- Scanning CDs and tracks **12**
- Pausing CD playback **12**

Audio Adjustments

- Introduction of audio adjustments **13**
- Using balance adjustment **13**
- Using the equalizer **14**
 - Recalling equalizer curves **14**
 - Adjusting equalizer curves **14**
- Adjusting loudness **14**
- Front image enhancer (FIE) **15**
- Adjusting source levels **15**

Initial Settings

- Adjusting initial settings **16**
- Setting the time **16**
- Setting the FM tuning step **16**
- Setting the AM tuning step **17**
- Switching the auxiliary setting **17**

Additional Information

- Setting the time display on or off **17**
- Using the AUX source **17**
 - Selecting AUX as the source **17**
- Cassette tapes **18**
- Cleaning the playback head **18**
- Music search and repeat functions **18**
- Specifications **19**

About this manual

This unit features a number of sophisticated functions ensuring superior reception and operation. All the functions have been designed for the easiest possible use, but many are not self-explanatory. This operation manual will help you benefit fully from this product's potential and to maximize your listening enjoyment.

We recommend that you familiarize yourself with the functions and their operation by reading through the manual before you begin using this unit. It is especially important that you read and observe precautions on this page and in other sections.

This manual explains head unit operation. You can perform the same operations with the remote control (CD-R30). ▣

Precautions

- Keep this manual handy as a reference for operating procedures and precautions.
- Always keep the volume low enough so you can hear sounds outside of the car.
- Protect this product from moisture.
- If the battery is disconnected or discharged, the preset memory will be erased and must be reprogrammed.
- Should this product fail to operate properly, contact your dealer or nearest authorized Pioneer Service Station. ▣

Before You Start

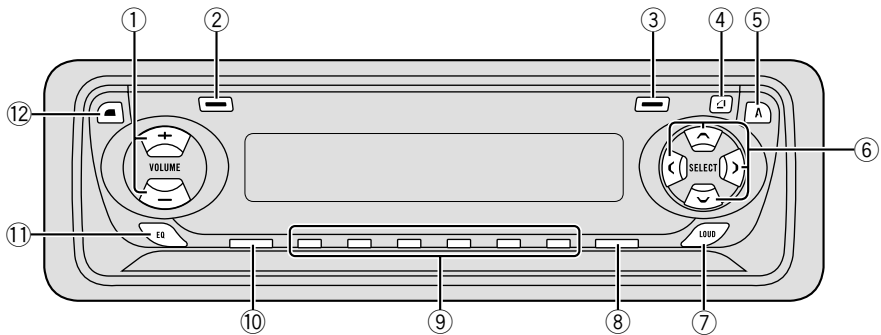

What's what

① **VOLUME button**

Press to increase or decrease the volume.

② **LOCAL button (tuner)**

Press to switch local function on or off.

PAUSE/SCAN button

Press to switch pause function on or off.
Press and hold for two seconds to switch scan function on or off.

③ **BSM button (tuner)**

Press and hold for two seconds to switch BSM function on or off.

REPEAT/RANDOM button

Press to switch repeat function on or off.
Press and hold for two seconds to switch random function on or off.

④ **OPEN button**

Press to open the front panel.

⑤ **AUDIO button**

Press to select various sound quality controls.

⑥ **▲/▼/◀/▶ buttons**

Press to do manual seek tuning, fast forward, reverse and track search controls. Also used for controlling 3 functions.

⑦ **LOUDNESS button**

Press to switch loudness function on or off.

⑧ **BAND button**

Press to select among three FM and one AM band and cancel the control mode of functions.

⑨ **1-6 (PRESET TUNING) buttons**

Press for preset tuning and disc number search when using a multi-CD player.

⑩ **SOURCE button**

This unit is switched on by selecting a source. Press to cycle through all of the available sources.

⑪ **EQ button**

Press to select various equalizer curves.

⑫ **CLOCK button**

Press to switch clock display on or off.

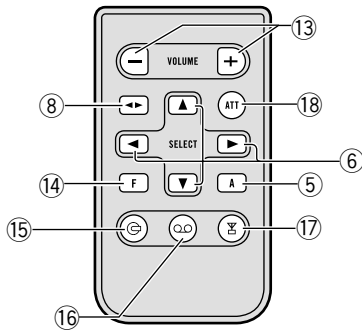

Optional remote control

The remote control CD-R30 is sold separately. Operation is the same as when using the button on the head unit. See the explanation of the head unit about the operation of each button with the exception of **ATT**, which is explained below.

- ⑬ **+/- button**
Press to increase or decrease the volume.
- ⑭ **FUNCTION button**
Not used.
- ⑮ **CD button**
Press once to select a CD.
- ⑯ **Cassette button**
Press once to select a cassette.
- ⑰ **TUNER button**
Press once to select a tuner.
- ⑱ **ATT button**
Press to quickly lower the volume level, by about 90%. Press once more to return to the original volume level. ■

Before You Start

Protecting your unit from theft

The front panel can be detached from the head unit and stored in the protective case provided to discourage theft.

- Keep the front panel closed while driving.

Important

- Never use force or grip the display and the buttons tightly when removing or attaching.
- Avoid subjecting the front panel to excessive shocks.
- Keep the front panel out of direct sunlight and high temperatures.

Removing the front panel

1 Press OPEN to open the front panel.

2 Grip the left side of the front panel and pull it gently outward.

Take care not to grip it tightly or drop it.

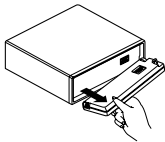

3 Put the front panel into the protective case provided for safe keeping.

Attaching the front panel

Replace the front panel by holding it upright to this unit and clipping it securely into the mounting hooks.

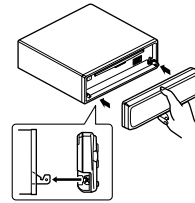

Turning the unit on

Press SOURCE to turn the unit on.

When you select a source the unit is turned on.



Selecting a source

You can select a source you want to listen to. To switch to the cassette player, load a cassette tape in this unit (refer to page 9).

Press SOURCE to select a source.

Press **SOURCE** repeatedly to switch between the following sources:

Tuner—**Cassette player**—**Multi-CD player**
—**External unit**—**AUX**



Notes

- In the following cases, the sound source will not change:
 - When a product corresponding to each source is not connected to this unit.
 - When no cassette is set in this unit.
 - When no magazine is set in the multi-CD player.
 - When the AUX (external input) is set to off (refer to page 17).
- External Unit refers to a Pioneer product (such as one available in the future) that, although incompatible as a source, enables control of basic functions by this product. Only one External Unit can be controlled by this product.
- When this unit's blue/white lead is connected to the car's auto-antenna relay control terminal, the car's antenna extends when this unit's source is switched on. To retract the antenna, switch the source off.

Turning the unit off

Press **SOURCE** and hold for at least one second to turn the unit off.

Listening to the radio

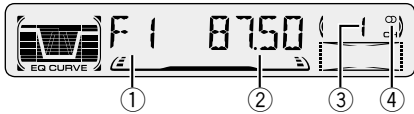

If you are using this unit in North, Central or South America, reset the AM tuning step (see *Setting the AM tuning step* on page 17).

- ① **BAND indicator**
Shows which band the radio is tuned to, AM or FM.
- ② **FREQUENCY indicator**
Shows to which frequency the tuner is tuned.
- ③ **PRESET NUMBER indicator**
Shows what preset has been selected.
- ④ **STEREO (∞) indicator**
Shows that the frequency selected is being broadcast in stereo.

1 Press **SOURCE** to select the tuner.

2 Use **VOLUME** to adjust the sound level.

When you press **VOLUME** up/+, the volume is raised and when pressed down/-, the volume is lowered.

3 Press **BAND** to select a band.

Press **BAND** until the desired band is displayed, **F1**, **F2**, **F3** for FM or **AM**.

4 To perform manual tuning, press ◀ or ▶ with quick presses.

The frequencies move up or down step by step.

5 To perform seek tuning, press and hold ◀ or ▶ for about one second and release.

The tuner will scan the frequencies until a broadcast strong enough for good reception is found.

- You can cancel seek tuning by pressing either ◀ or ▶ with a quick press.
- If you press and hold ◀ or ▶ you can skip broadcasting stations. Seek tuning starts as soon as you release the buttons.

Note

- When the frequency selected is being broadcast in stereo the **STEREO** (∞) indicator will light. ◻

Storing and recalling broadcast frequencies

If you press any of the **PRESET TUNING** buttons you can easily store up to six broadcast frequencies for later recall with the touch of a button.

When you find a frequency that you want to store in memory press a PRESET TUNING button and hold until the preset number stops flashing.

The number you have pressed will flash in the **PRESET NUMBER** indicator and then remain lit. The selected radio station frequency has been stored in memory.

The next time you press the same **PRESET TUNING** button the radio station frequency is recalled from memory.



Notes

- Up to 18 FM stations, 6 for each of the three FM bands, and 6 AM stations can be stored in memory.
- You can also use ▲ and ▼ to recall radio station frequencies assigned to **PRESET TUNING** buttons. ▣

Tuning in strong signals

Local seek tuning lets you tune in only those radio stations with sufficiently strong signals for good reception.

1 Press LOCAL to turn local seek tuning on.

Local seek sensitivity (**LOC**) appears in the display.

2 When you want to return to normal seek tuning, press LOCAL to turn local seek tuning off. ▣

Storing the strongest broadcast frequencies

BSM (best stations memory) lets you automatically store the six strongest broadcast frequencies under **PRESET TUNING** buttons 1–6 and once stored there you can tune in to those frequencies with the touch of a button.

Press and hold BSM for about two seconds to turn BSM on.

BSM begins to flash. While **BSM** is flashing the six strongest broadcast frequencies will be stored under **PRESET TUNING** buttons in order of their signal strength. When finished, **BSM** stops flashing.

- To cancel the storage process, press **BSM**.



Note

- Storing broadcast frequencies with BSM may replace broadcast frequencies you have saved using **PRESET TUNING**. ▣

Playing a tape

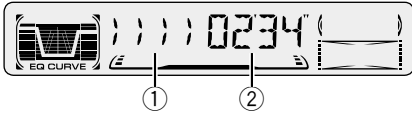

① **TAPE DIRECTION indicator**

Shows the direction of the tape transport.

② **PLAY TIME indicator**

Shows the elapsed playing time of the current side of the tape.

1 Press OPEN to open the front panel.

Cassette loading slot appears.

2 Insert a cassette tape into the cassette loading slot.

Playback will automatically start.

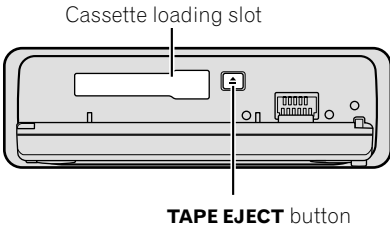

- You can eject a cassette tape by pressing **TAPE EJECT**.

3 Close the front panel.

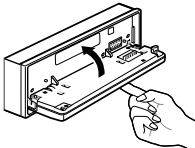

- After a cassette tape has been inserted, press **SOURCE** to select the Cassette player.

4 Use VOLUME to adjust the sound level.

When you press **VOLUME** up/+, the volume is raised and when pressed down/–, the volume is lowered.

5 To perform fast forward or rewind, press ◀ or ▶.

FF or **REW** appears in the display.

- To cancel fast forward or rewind and return to playback, press **BAND**.
- You can cancel fast forward or rewind by pressing ◀ or ▶ in the same direction twice.

6 To perform forward or rewind music search, press ◀ or ▶ twice.

F-MS (forward music search) or **R-MS** (rewind music search) appears in the display. The cassette player will fast forward or rewind to the next or previous blank spot on the tape and begin to play.

- To cancel music search and return to playback, press **BAND**.
- You can cancel music search by pressing ◀ or ▶ in the same direction again.

7 To change the direction of the tape transport, press BAND.



Notes

- Do not insert anything other than a cassette tape into the cassette loading slot.
- **PLAY TIME** indicator starts from **00'00"** in the following cases:
 - When a tape is inserted
 - When the tape direction is changed
 - When you rewind the tape to the beginning
- **PLAY TIME** indicator is halted when fast forward, rewind or music search is operating. ◻

Cassette Player

Repeating play

Repeat play lets you hear the same track over again.

1 Press REPEAT/RANDOM to turn repeat play on.

RPT appears in the display. The track presently playing will play and then repeat.

2 Press REPEAT/RANDOM to turn repeat play off.

The track presently playing will continue to play and then play the next track.

Skipping blank tape sections

Blank skip automatically fast forwards to the next song if there is a long period of silence (12 seconds or longer) between songs.

1 Press 5 to turn blank skip on.

BS ON appears in the display. Long periods of silence between songs will be skipped.

2 Press 5 to turn blank skip off.

BS OFF appears in the display. The complete cassette tape will play.

Radio intercept

This function allows you to listen to the radio during tape fast-forwarding/rewinding.

1 Press 6 to turn radio intercept on.

RI ON appears in the display.

2 Press 6 to turn radio intercept off.

RI OFF appears in the display.

Multi-CD Player

Playing a CD

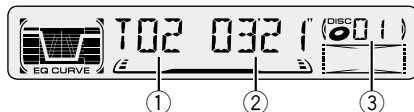

You can use this unit to control a multi-CD player, which is sold separately.

① **TRACK NUMBER indicator**

Shows the track currently playing.

② **PLAY TIME indicator**

Shows the elapsed playing time of the current track.

③ **DISC NUMBER indicator**

Shows the disc currently playing.

Multi-CD Player

1 Press SOURCE to select the multi-CD player.

2 Use VOLUME to adjust the sound level.

When you press **VOLUME** up/+, the volume is raised and when pressed down/–, the volume is lowered.

3 Select a disc you want to listen to with the 1 to 6 buttons.

For discs located at 1 to 6, press the corresponding number button.

If you want to select a disc located at 7 to 12, press and hold the corresponding numbers such as **1** for disc 7, until the disc number appears in the display.

- You can also sequentially select a disc by pressing **▲/▼**.

4 To perform fast forward or reverse, press and hold ◀ or ▶.

5 To skip back or forward to another track, press ◀ or ▶.

Pressing **▶** skips to the start of the next track. Pressing **◀** once skips to the start of the current track. Pressing again will skip to the previous track.



Notes

- When the multi-CD player performs the preparatory operations, **READY** is displayed.
- If the multi-CD player does not operate properly, an error message such as **ERROR-14** may be displayed. Refer to the multi-CD player owner's manual.
- If there are no discs in the multi-CD player magazine, **NO DISC** is displayed.

50-disc multi-CD player

Only those functions described in this manual are supported for 50-disc multi-CD players.

Repeating play

There are three repeat play ranges for the multi-CD player: Multi-CD player repeat, one-track repeat, and disc repeat.

Press REPEAT/RANDOM to select the repeat range.

Press **REPEAT/RANDOM** until the desired repeat range appears in the display.

- **Nothing's displayed** — Repeat all discs in the multi-CD player
- **RPT** — Repeat just the current track
- **DISC** — Repeat the current disc



Notes

- If you select other discs during repeat play, the repeat play range changes to multi-CD player repeat.
- If you perform track search or fast forward/reverse during **RPT** (one-track repeat), the repeat play range changes to **DISC** (disc repeat).

Playing tracks in a random order

Random play lets you play back tracks in a random order within the repeat range, multi-CD player repeat and disc repeat.

1 Select the repeat range.

Refer to *Repeating play* on page 11.

2 Press and hold REPEAT/RANDOM for about two seconds to turn random play on.

DRDM (random playing in a disc) or **RDM** (random playing in a magazine) appears in the display. Tracks will play in a random order within the previously selected multi-CD player repeat or disc repeat ranges.

3 Press and hold REPEAT/RANDOM for about two seconds to turn random play off.

Tracks will continue to play in order. 

Scanning CDs and tracks

While you are using **DISC** (disc repeat), the beginning of each track on the selected disc plays for about 10 seconds. When you are using multi-CD player repeat, the beginning of the first track of each disc is played for about 10 seconds.

1 Select the repeat range.

Refer to *Repeating play* on page 11.

2 Press and hold PAUSE/SCAN for about two seconds to turn scan play on.

DSCN (scanning tracks) or **SCAN** (scanning discs) appears in the display. The first 10 seconds of each track of the present disc (or the first track of each disc) is played.

3 When you find the desired track (or disc) press and hold PAUSE/SCAN for about two seconds to turn scan play off.

The track (or disc) will continue to play.



Note

- After track or disc scanning is finished, normal playback of the tracks will begin again.



Pausing CD playback

Pause lets you temporarily stop playback of the CD.

1 Press PAUSE/SCAN to turn pause on.

PAUSE appears in the display. Play of the current track pauses.

2 Press PAUSE/SCAN to turn pause off.

Play will resume at the same point that you turned pause on. 

Introduction of audio adjustments



① AUDIO display

Shows the audio adjustments status.

② LOUD indicator

Appears in the display when loudness is turned on.

Press **AUDIO** to display the audio function names.

Press **AUDIO** repeatedly to switch between the following audio functions:

FAD (balance adjustment)—**EQ-L** (equalizer)—

LOUD (loudness)—**FIE** (front image

enhancer)—**SLA** (source level adjustment)

- When selecting the FM tuner as the source, you cannot switch to **SLA**.

- To return to the display of each source, press **BAND**.



Note

- If you do not operate the audio function within about 30 seconds, the display is automatically returned to the source display. 

Using balance adjustment

You can select a fader/balance setting that provides an ideal listening environment in all occupied seats.

1 Press **AUDIO** to select **FAD**.

Press **AUDIO** until **FAD** appears in the display.

- If the balance setting has been previously adjusted, **BAL** will be displayed.

2 Press **▲** or **▼** to adjust front/rear speaker balance.

Each press of **▲** or **▼** moves the front/rear speaker balance towards the front or the rear.

- **FAD F15 – FAD R15** is displayed as the front/rear speaker balance moves from front to rear.

- **FAD 0** is the proper setting when only two speakers are used.

3 Press **◀** or **▶** to adjust left/right speaker balance.

When you press **◀** or **▶**, **BAL 0** is displayed.

Each press of **◀** or **▶** moves the left/right speaker balance towards the left or the right.

- **BAL L9 – BAL R9** is displayed as the left/right speaker balance moves from left to right. 

Using the equalizer

The equalizer lets you adjust the equalization to match car interior acoustic characteristics as desired.

Recalling equalizer curves

There are six stored equalizer curves which you can easily recall at any time. Here is a list of the equalizer curves:

Display	Equalizer curve
SPR-BASS	Super bass
POWERFUL	Powerful
NATURAL	Natural
VOCAL	Vocal
CUSTOM	Custom
EQ FLAT	Flat

- **CUSTOM** is an adjusted equalizer curve that you create.

- When **EQ FLAT** has been selected no supplement or correction is made to the sound. This is useful to check the effect of the equalizer curves by switching alternatively between **EQ FLAT** and a set equalizer curve.

Press EQ to select the equalizer.

- If the equalizer has been previously set to an equalizer curve other than **POWERFUL** then the title of that previously selected equalizer curve will be displayed, such as **SPR-BASS**, **NATURAL**, **VOCAL**, **CUSTOM**, or **EQ FLAT**.

Adjusting equalizer curves

You can adjust the currently selected equalizer curve setting as desired. Adjusted equalizer curve settings are memorized in **CUSTOM**.

1 Press AUDIO to select the equalizer mode.

Press **AUDIO** until **EQ-L/EQ-M/EQ-H** appears in the display.

2 Select the band you want to adjust with the ◀/▶.

EQ-L (low) —EQ-M (mid) —EQ-H (high)

3 Press ▲ or ▼ to adjust the equalizer curve.

Each press of ▲ or ▼ increases or decreases the equalizer curve respectively.

- **+6 — -6** is displayed as the equalizer curve is increased or decreased.
- The actual range of the adjustments are different depending on which equalizer curve is selected.



Note

- If you make adjustments when a curve other than **CUSTOM** is selected, the newly adjusted curve will replace the previous curve. Then a new curve with **CUSTOM** appears on the display while selecting the equalizer curve. ▣

Adjusting loudness

Loudness compensates for deficiencies in the low- and high-sound ranges at low volume.

1 Press AUDIO to select LOUD.

Press **AUDIO** until **LOUD** appears in the display.

Audio Adjustments

2 Select LOUD on or off with ▲/▼.

3 Select the desired level with ◀▶.

LOW (low) —MID (mid) —HI (high)



Note

- You can also switch **LOUD** on or off by pressing the **LOUDNESS**.

Front image enhancer (FIE)

The F.I.E. (Front Image Enhancer) function is a simple method of enhancing front imaging by cutting mid- and high-range frequency output from the rear speakers, limiting their output to low-range frequencies. You can select the frequency you want to cut.



Precaution

- When the F.I.E. function is deactivated, the rear speakers output sound of all frequencies, not just bass sounds. Reduce the volume before disengaging F.I.E. to prevent a sudden increase in volume.

1 Press AUDIO to select FIE.

Press **AUDIO** until **FIE** appears in the display.

2 Select FIE on or off with ▲/▼.

3 Select the desired frequency with ◀▶.

100—160—250 (Hz)



Notes

- After switching the F.I.E. function ON, select the Fader/Balance mode in the Audio Menu, and adjust front and rear speaker volume levels until they are balanced.
- Switch the F.I.E. function OFF when using a 2-speaker system.

Adjusting source levels

SLA (Source level adjustment) lets you adjust the volume level of each source to prevent radical changes in volume when switching between sources.

- Settings are based on the volume level of the FM tuner, which remains unchanged.

1 Compare the FM tuner volume level with the level of the source you wish to adjust.

2 Press AUDIO to select SLA.

Press **AUDIO** until **SLA** appears in the display.

3 Press ▲ or ▼ to adjust the source volume.

Each press of ▲ or ▼ increases or decreases the source volume.

- **SLA +4 – SLA -4** is displayed as the source volume is increased or decreased.



Notes

- Since the FM tuner volume is the control, it is not possible to apply source level adjustments to the FM tuner.
- The AM tuner volume level can also be adjusted with source level adjustments.

Adjusting initial settings



Initial settings lets you perform initial set up of different settings for this unit.

1 Press SOURCE and hold until the unit turns off.

2 Press AUDIO and hold until TIME appears in the display.

Press **AUDIO** repeatedly to switch between the following settings:

TIME—FM STEP—AM STEP—AUX

Use the following instructions to operate each particular setting.

- To cancel initial settings, press **BAND**.
- You can also cancel initial settings by holding down **AUDIO** until the unit turns off. 

Setting the time

This is used to set the time on the unit's clock display.

1 Press AUDIO to select the time.

Press **AUDIO** until the time appears in the display.

2 Select the portion of the time display you wish to set with ◀/▶.

Pressing ◀/▶ will select a portion of the clock display:

HOUR—MINUTE

As you select portions of the clock display the portion selected will blink.

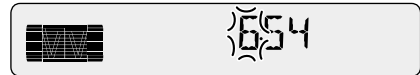

3 Select the correct time with ▲/▼.

Pressing ▲ will increase the selected hour or minute. Pressing ▼ will decrease the selected hour or minute. 

Setting the FM tuning step

The tuning step employed by Seek Tuning in the FM mode can be switched between 100 kHz (preset at the factory) and 50 kHz.

1 Press AUDIO to select FM STEP.

Press **AUDIO** repeatedly until **FM 100** appears in the display.

2 Select the FM tuning step with ◀/▶.



Note

- If seek tuning is performed in 50 kHz steps, stations may be tuned in imprecisely. Tune in the stations with manual tuning or use seek tuning again.

Setting the AM tuning step

The AM tuning step can be switched between 9 kHz, the preset step, and 10 kHz. When using the tuner in North, Central or South America, reset the tuning step from 9 kHz (531 – 1,602 kHz allowable) to 10 kHz (530 – 1,640 kHz allowable).

1 Press **AUDIO** to select **AM STEP**.

Press **AUDIO** repeatedly until **AM 9** appears in the display.

2 Select the AM tuning step with **◀/▶**.

Pressing **◀/▶** will switch the AM tuning step between 9 kHz and 10 kHz. The selected AM tuning step will appear in the display.

Switching the auxiliary setting

It is possible to use auxiliary equipment with this unit. Activate the auxiliary setting when using external equipment connected to this unit.

1 Press **AUDIO** to select **AUX**.

Press **AUDIO** repeatedly until **AUX** appears in the display.

2 Select **AUX** on or off with **▲/▼**.

Pressing **▲/▼** will switch **AUX** between on and off and that status will be displayed.

Setting the time display on or off

You can turn the time display on even when the sources and the demonstration are off.

Press **CLOCK** to select the time display.

Each press of **CLOCK** turns time display on or off.

- The time display disappears temporarily when you perform other operations, but the time indication is displayed again after 25 seconds.

Using the AUX source

An IP-BUS-RCA Interconnector such as the CD-RB20 or CD-RB10 (sold separately) lets you connect this unit to auxiliary equipment featuring RCA output. For more details, refer to the IP-BUS-RCA Interconnector owner's manual.

Selecting AUX as the source

Press **SOURCE** to select **AUX** as the source.

Press **SOURCE** until **AUX** appears in the display.

- If the auxiliary setting is not switched on, **AUX** cannot be selected. For more details, see *Switching the auxiliary setting* on this page.

Cassette tapes

- A loose, torn or warped label on a cassette tape can jam the cassette player. Do not use cassette tapes with loose, torn or warped labels.
- Cassette tapes longer than C-90 (90-minute tapes) can cause the tape to jam in the cassette player. Do not use tapes longer than C-90.
- Cassette tapes exposed to high temperatures may warp and jam the cassette player. Keep cassettes out of direct sunlight or places where there are high temperatures.



- Store unused tapes in a tape case where there is no danger of them becoming loose, dirty or dusty. ▣

Cleaning the playback head

If the head becomes dirty, the sound quality will get bad and there will be sound dropouts and other problems. If you have any of these problems the head may need cleaning. ▣

Music search and repeat functions

Music search and repeat functions may not work with these tapes:

- A tape with a gap of 4 seconds or less between songs
- A tape containing dialog or other non-musical content, with pauses lasting 4 seconds or longer
- A tape with an extremely quiet passage in the music lasting for 4 seconds or longer ▣

Specifications

General

Power source	14.4 V DC (10.8 – 15.1 V allowable)
Grounding system	Negative type
Max. current consumption	10.0 A
Dimensions (W × H × D): (DIN)	
Chassis	178 × 50 × 157 mm
Nose	188 × 58 × 20 mm
(D)	
Chassis	178 × 50 × 162 mm
Nose	170 × 46 × 15 mm
Weight	1.4 kg

Audio

Continuous power output is 22 W per channel min. into 4 ohms, both channels driven 50 to 15,000 Hz with no more than 5% THD.

Maximum power output 50 W × 4

Load impedance 4 Ω (4 – 8 Ω allowable)

Preout max output level/output impedance 2.2 V/1 kΩ

Equalizer (3-Band Equalizer):

(LOW)	Level : ±12 dB
(MID)	Level : ±12 dB
(HIGH)	Level : ±12 dB

Loudness contour

(LOW)	+3.5 dB (100 Hz), +3 dB (10 kHz)
(MID)	+10 dB (100 Hz), +6.5 dB (10 kHz)
(HIGH)	+11 dB (100 Hz), +11 dB (10 kHz) (volume : -30 dB)

Cassette player

Tape	Compact cassette tape (C-30 – C-90)
Tape speed	4.8 cm/sec
Fast forward/rewinding time	Approx. 100 sec (C-60)
Wow & flutter	0.09% (WRMS)
Frequency response	30 – 16,000 Hz (±3 dB)
Stereo separation	45 dB
Signal-to-noise ratio	61 dB (IEC-A network)

FM tuner

Frequency range	87.5 – 108.0 MHz
Usable sensitivity	11 dBf (1.1 μV/75 Ω, mono, S/N: 30 dB)
50 dB quieting sensitivity ...	17 dBf (2.2 μV/75 Ω, mono)
Signal-to-noise ratio	58 dB (IEC-A network)
Distortion	0.5% (at 65 dBf, 1 kHz, stereo)
Frequency response	30 – 15,000 Hz (±3 dB)
Stereo separation	24 dB (at 65 dBf, 1 kHz)

AM tuner

Frequency range	531 – 1,602 kHz (9 kHz)
	530 – 1,640 kHz (10 kHz)
Usable sensitivity	20 μV (S/N: 20 dB)
Selectivity	50 dB (±9 kHz)
	50 dB (±10 kHz)



Note

- Specifications and the design are subject to possible modifications without notice due to improvements. ■

感謝惠購先鋒產品。

請通讀本使用說明書，以了解本機的正确操作方法。閱讀完畢後，請妥善保存，以備日後參考。

開始使用之前

- 關於本說明書 2
- 注意事項 2
- 按鈕介紹 3
- 選購的遙控器 4
- 本機防盜措施 5
 - 拆卸前面板 5
 - 安裝前面板 5

開關電源

- 打開本機 6
- 選擇音源 6
- 關閉本機 6

調諧器

- 收聽收音機 7
- 儲存和調用廣播頻率 8
- 強訊號調諧 8
- 儲存訊號最強的廣播頻率 8

卡式磁帶播放機

- 播放磁帶 9
- 反復播放 10
- 跳過磁帶的空白部分 10
- 廣播截聽 10

內置式鐳射唱機

- 播放鐳射唱片 10
- 50 碟鐳射唱機 11
- 隨機播放 11
- 反復播放 11
- 掃描唱碟和曲目 12
- 暫停鐳射唱片的播放 12

音頻調整

- 音頻調整介紹 13
- 使用平衡調整 13
- 使用等化器 14
 - 調用等化器曲線 14
 - 調整等化器曲線 14
- 調整響度 14
- 前聲像增強器 (FIE) 15
- 調整音源級 15

初始設置

- 調整初始設置 16
- 設置時間 16
- 設置 FM 調諧幅度 16
- 設置 AM 調諧幅度 17
- 切換輔助設置 17

附加資訊

- 將時間顯示設定為打開或關閉狀態 17
- 使用 AUX 音源 17
 - 選擇 AUX 作為音源 17
- 卡式磁帶 18
- 清潔播放磁頭 18
- 音樂搜索和反復播放功能 18
- 規格 19

關於本說明書

本機含有許多高級功能，用於保證高質量的節目接收及機器運轉。所有功能均經專門設計，以盡可能使本機簡便易用。但很多功能並非一目了然，本使用說明書可幫助您充分發揮本機的性能，從而使您在音樂欣賞方面獲得最大享受。

我們建議您在開始使用本機之前，先通讀一遍本說明書，以便熟悉其功能和操作方法。

本頁及其他各章節中所述的注意事項尤為重要，請務必閱讀並按此操作。

本手冊說明的是主機的操作方法。您可以用遙控器（CD-R30）執行相同的操作。▣

注意事項

- 請將本說明書存放在方便拿取之處，以便參閱操作步驟和注意事項。
- 請勿將本機音量調得過高，以能夠聽見車外聲響為宜。
- 請務必防止本機受潮。
- 如果電池斷路或電量放盡，則預設的記憶內容將被刪除，需要重新設置。
- 如果本產品不能正常運作，請聯繫經銷商或就近聯繫先鋒特約維修站。▣

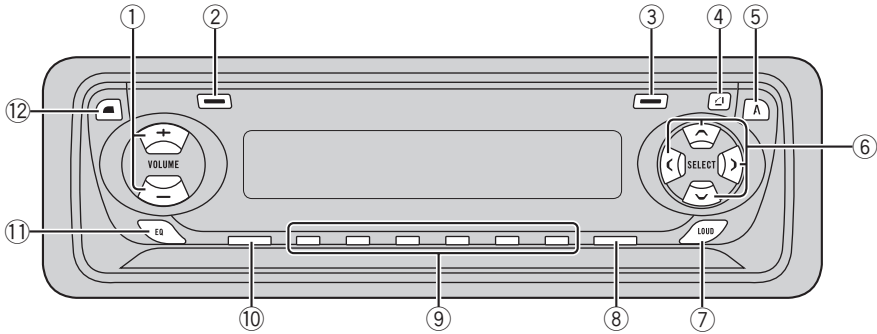

按鈕介紹

① VOLUME 按鈕

按該按鈕增減音量。

② LOCAL 按鈕

按該按鈕打開或關閉本地功能。

PAUSE/SCAN 按鈕

按該按鈕啟動或關閉暫停功能。

按住該按鈕兩秒種啟動或關閉掃描功能。

③ BSM 按鈕

按住該鈕兩秒，打開或關閉 BSM 功能。

PEPREAT/RANDOM 按鈕

按該按鈕啟動或關閉反復播放功能。

按住該按鈕兩秒種啟動或關閉隨機播放功能。

④ OPEN 按鈕

按該鈕打開前面板。

⑤ AUDIO 按鈕

按該鈕可選擇不同的音質控制方式。

⑥ ▲/▼/◀/▶ 按鈕

按這些按鈕可進行手動搜索調諧、快進、快退和曲目搜索控制。這些按鈕還用於控制功能。

⑦ LOUDNESS 按鈕

按該鈕可開關響度功能。

⑧ BAND 按鈕

按該鈕可在三個 FM 或 AM 波段中進行選擇，還可取消功能的控制模式。

⑨ 1-6(PRESET TURNING) 按鈕

使用多碟鐳射唱機時，按該按鈕啟動預置調諧和唱碟號碼搜索功能。

⑩ SOURCE 按鈕

通過選擇某一音源的方式打開本機。按該鈕可輪流切換現有的音源。

⑪ EQ 按鈕

按該鈕可選擇不同的等化器曲線。

⑫ CLOCK 按鈕

按該鈕可開關時鐘顯示。☐

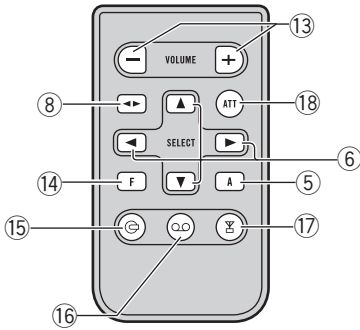

選購的遙控器

遙控器CD-R30為選購配件。操作方法與主機上的按鈕相同。請參閱主機介紹，查詢除ATT外各按鈕的操作方法，其中**ATT**將在下文作一介紹。

- ⑬ **+/-** 按鈕
增加或降低音量。
- ⑭ **FUNCTION** 按鈕
不使用。
- ⑮ **CD** 按鈕
按一下，選擇一張CD。
- ⑯ **Cassette** 按鈕
按一下，選擇卡式磁帶。
- ⑰ **TUNER** 按鈕
按一下，選擇調諧器。
- ⑱ **ATT** 按鈕
按動該鈕，可快速降低音量級約90%。
再按一次，可返回至原來的音量級。▣

本機防盜措施

前面板可從主機上拆下並存放於護套中，以防本機失竊。

- 開車時，請將前面板闔上。

重要

- 拆卸和安裝本機時，請勿用力夾持顯示屏和按鈕或對它們施以強力。
- 請勿使前面板遭受過度的震動。
- 請勿將前面板暴露於直射陽光或高溫下。

拆卸前面板

1 按 OPEN 打開前面板。

2 握住前面板的左端，將其輕輕向外拉。
請小心不要猛烈拉扯或使其跌落。

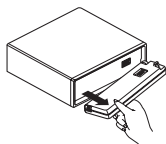

3 將前面板放入護套中妥善保存。

安裝前面板

若要更換前面板，請將其豎直得握至主機，並將其牢固得卡在安裝倒鉤中。

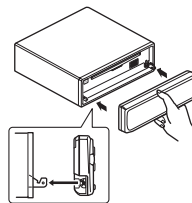

打開本機

按 **SOURCE** 打開本機。

當您選擇某一音源時，本機打開。◻

選擇音源

您可以選擇需收聽的音源。若要轉換至卡式磁帶播放機，則將卡式磁帶裝入機內（請參見第9頁）。

按 **SOURCE** 選擇音源。

反復按 **SOURCE** 可在下列音源之間進行轉換：

調諧器 – 卡式磁帶播放機 – 多碟鐳射唱機 – 外接裝置 – AUX



注意

- 在下列情況下，音源不會改變：
 - 當與各音源相應的設備沒有與本機連接時。
 - 機內無卡式磁帶時。
 - 多碟鐳射唱機未安裝唱碟匣時
 - AUX（外部輸入）設置為關閉時（請參閱第17頁）
- 外接裝置指的是，並不能作為本機的兼容音源，但可由本機控制其基本功能的先鋒產品（如以後推出的產品）。本機祇能控制一臺外接裝置。
- 如果本機的藍 / 白引線已經與汽車的自動天線繼電器控制端子相連，則當本機的音源打開時，汽車的天線將伸出。若要收回天線，則關閉音源。◻

關閉本機

按住 **SOURCE** 一秒鐘以上可關閉本機。◻

收聽收音機



如果在北美洲、中美洲或南美洲使用調諧器，請將 AM 調諧幅度從 9 kHz（出廠預設幅度）設置為 10 kHz。（請參見第 17 頁）

① BAND（波段）指示燈

顯示收音機的調諧波段是 AM 還是 FM。

② FREQUENCY（頻率）指示燈

顯示調諧器的調諧頻率。

③ PRESET NUMBER（預設號碼）指示燈

顯示所選擇的預設電台號碼。

④ STEREO（立體聲）(O) 指示燈

表明所選擇的頻率是以立體聲模式進行廣播。

1 按 SOURCE 選擇調諧器。

2 用 VOLUME 按鈕調整音量。

當您按 VOLUME 增 /+ 時，音量升高；當您按 VOLUME 減 /- 時，音量降低。

3 按 BAND 選擇波段。

按 BAND 直到顯示所需的波段：FM 的 F1、F2、F3 或 AM。

4 若要進行手動調諧，請快速按 ◀ 或 ▶。頻率逐步調高或調低。

5 若要進行搜索調諧，請按住 ◀ 或 ▶ 約一秒鐘，然後放開。

調諧器將掃描頻率，直到發現訊號足夠強且接收情況良好的電台。

- 您可以通過快速按 ◀ 或 ▶ 來取消搜索調諧。
- 如果您按住 ◀ 或 ▶，則可跳過正在廣播的電台。當您放開按鈕時，搜索調諧立即啟動。

注意

- 如果所選頻率以立體聲模式廣播，則 STEREO（立體聲）(O) 指示燈亮起。



儲存和調用廣播頻率

通過按任一 **PRESET TUNING** 按鈕，您可以輕鬆地儲存多至六個的廣播頻率，以後只需按一次按鈕便可將其調出。

當您找到需要儲存在記憶體中的頻率時，則按住 **PRESET TUNING** 按鈕直到預設號碼停止閃爍。

您所按的號碼將在 **PRESET NUMBER**（預設號碼）指示燈閃爍，然後保持點亮。此時，所選擇的無線電台頻率已儲存在記憶體中。當您下一次按同一個 **PRESET TUNING** 按鈕時，該無線電台頻率將從記憶體中調出。

注意

- 記憶體中最多可儲存 18 個 FM 電台（三個 FM 波段各 6 個電台）和 6 個 AM 電台。
- 您還可以用 ▲ 和 ▼ 調出已分配到 **PRESET TUNING** 按鈕的無線電台頻率。▣

強訊號調諧

本地搜索調諧功能祇能調諧訊號足夠強且接收情況良好的無線電台。

1 按 **LOCAL** 啟動本地搜索調諧功能。顯示屏上出現本地搜索靈敏標誌（**LOC**）。

2 若要返回正常搜索調諧，則按 **LOCAL** 關閉本地搜索調諧功能。▣

儲存訊號最強的廣播頻率

BSM（最佳電台記憶）可讓您將訊號最強的六個廣播頻率自動與 **PRESET TUNING** 按鈕 **1-6** 對應儲存。儲存之後，您只需按一次按鈕便可將其調出。

按住 **BSM** 約兩秒鐘，啟動 **BSM**。

BSM 開始閃爍。當 **BSM** 閃爍時，訊號最強的六個廣播頻率將與 **PRESET TUNING** 按鈕對應儲存，儲存時以訊號由強到弱為序。完成後，**BSM** 停止閃爍。

- 若要取消儲存模式，請按 **BSM**。

注意

- 利用 **BSM** 儲存的訊號最強的廣播頻率可能會把您通過 **PRESET TUNING** 儲存的廣播頻率替換掉。▣

卡式磁帶播放機

播放磁帶

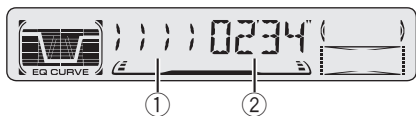

① TAPE DIRECTION 指示燈

顯示磁帶的走帶方向。

② PLAY TIME (播放時間) 指示燈

顯示當前曲目的已播放時間。

1 按 OPEN，打開前面板。

卡式磁帶裝載槽出現。

2 將卡式磁帶插入磁帶裝載槽。

播放將自動開始。

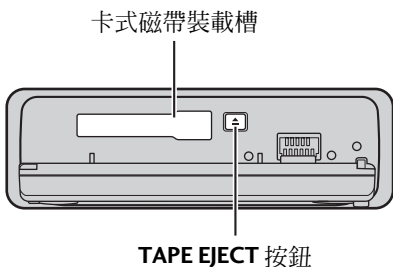

- 您可以按動 **CD EJECT**，退出鐳射唱片。

3 闔上前面板。

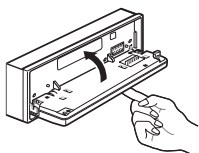

- 卡式磁帶插入後，按 **SOURCE** 選擇卡式磁帶播放機。

4 用 VOLUME 調整音量。

當您按 **VOLUME** 增 /+ 時，音量升高；當您按 **VOLUME** 減 /- 時，音量降低。

5 若要進行快進或快退，則按住 ◀ 或 ▶。 **FF** 或 **REW** 出現在顯示器中。

- 若要取消快進或倒帶，恢復播放，則按 **BAND**。
- 您可以按同一個 ◀ 或 ▶ 兩次以取消快進或倒帶。

6 要執行正向或反向音樂搜索，按 ◀ 或 ▶ 兩次。

F-MS (正向音樂搜索) 或 **R-MS** (反向音樂搜索) 出現在顯示器中。卡式磁帶播放機將快進或倒帶至磁帶中下一個或上一個空白區域並開始播放。

- 若要取消音樂搜索，恢復播放，則按 **BAND**。
- 您可以按同一個 ◀ 或 ▶ 兩次以取消快進或倒帶。

7 要改變磁帶的走帶方向，按 **BAND**。

注意

- 請勿將除卡式磁帶以外的物體插入磁帶裝載槽。
- 在下列情況下，**PLAY TIME** 指示燈從 **00'00"** 開始計數。
 - 當磁帶插入時
 - 當磁帶方向改變時
 - 當您將磁帶倒至開始處時
- 當快進、倒帶或音樂搜索正在執行時，**PLAY TIME** 指示燈停止工作。◻

反復播放

您可以利用反復播放功能反復欣賞同一曲目。

1 按 **REPEAT/RANDOM**，啟動反復播放功能。

顯示屏上出現 **RPT**。當前正在播放的曲目將被反復播放。

2 按 **REPEAT/RANDOM**，關閉反復播放功能。

當前正在播放的曲目將繼續播放，然後播放下一曲目。▣

跳過磁帶的空白部分

如果在兩首曲子之間有較長一段無聲部分（不少於 12 秒），則空白跳躍功能將自動使磁帶快進至下一首曲子。

1 按 5 啟動空白跳躍功能。

BS ON 出現在顯示器中。曲子之間較長的無聲部分將被跳過。

2 按 5 關閉空白跳躍功能。

BS OFF 出現在顯示器中。卡式磁帶將被完整播放。▣

廣播截聽

該功能允許您在磁帶快進 / 倒帶時收聽廣播節目。

1 按 6 啟動廣播截聽功能。

RI ON 出現在顯示器中。

2 按 6 關閉廣播截聽功能。

RI OFF 出現在顯示器中。▣

播放鐳射唱片

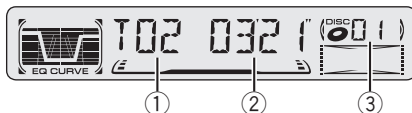

您可以用本機控制一臺另購的多碟鐳射唱機。

① **TRACK NUMBER** 指示燈

顯示當前播放的曲目。

② **PLAY TIME** 指示燈

顯示當前曲目的已播放時間。

③ **DISC NUMBER** 指示燈

顯示當前播放的唱碟。

1 按 **SOURCE** 選擇多碟鐳射唱機。

2 用 **VOLUME** 調節音量。

當您按 **VOLUME** 增 /+ 時，音量升高；當您按 **VOLUME** 減 /- 時，音量降低。

3 用 1 至 6 按鈕選擇您要欣賞的唱碟。

對於位於 1 至 6 位置的唱碟，請按相應的數字按鈕。

如果您要選擇位於 7 至 12 位置的唱碟，則按住相應的數字按鈕（如 1 對應唱碟 7），直至唱碟號碼出現在顯示器中。

● 您也可以用 ▲/▼ 按順序選擇唱碟。

4 若要執行快進或快倒，則按住 ◀ 或 ▶ 。

5 若要跳至上一首或下一首曲目，則按 ◀ 或 ▶ 。

按 ◀ 跳至下一首曲目的開始處，按一次 ▶ 跳至當前曲目的開始處。再按一次將跳至上一首曲目。

注意

- 當多碟鐳射唱機執行準備性操作時，**READY** 將顯示出來。
- 如果多碟鐳射唱機運作不正常，則 **ERROR-14** 之類的錯誤訊息將顯示出來。請參閱多碟鐳射唱機的使用說明書。
- 如果多碟鐳射唱機的唱碟匣中沒有唱碟，則顯示 **NO DISC**。◻

50 碟鐳射唱機

50 碟鐳射唱機僅支持本手冊中介紹的功能。



反復播放

多碟鐳射唱機共有三種反復播放範圍：多碟鐳射唱機反復播放、單曲反復播放和唱碟反復播放。

按 **REPEAT/RANDOM** 選擇反復播放範圍。

按 **REPEAT/RANDOM** 直至所需的反復播放範圍出現在顯示器中。

- **無內容顯示** – 反復播放多碟鐳射唱機中的所有唱碟
- **RPT** – 僅反復播放當前曲目
- **DISC** – 反復播放當前唱碟



注意

- 如果您在反復播放的過程中選擇了其他唱碟，則反復播放範圍將改變為多碟鐳射唱機反復播放。
- 如果在 **RPT**（單曲反復播放）過程中執行了曲目搜索或快進 / 快倒操作，則反復播放範圍改變為 **DISC**（唱碟反復播放）。◻

以隨機順序播放曲目

隨機播放功能可讓您在反復播放、多碟鐳射唱機反復播放和唱碟反復播放的範圍內，以隨機順序播放曲目。

1 選擇反復播放範圍。

請參閱第 11 頁反復播放。

2 按住 REPEAT/RANDOM 約兩秒種啓動隨機播放。

DRDM（唱碟隨機播放）或 **RDM**（唱碟匣隨機播放）出現在顯示器中。本機將在前面選擇的多碟鐳射唱機反復播放或唱碟反復播放的範圍內，以隨機順序播放曲目。

3 按住 REPEAT/RANDOM 約兩秒種關閉隨機播放。

曲目將按順序繼續播放。

掃描唱碟和曲目

當您正在使用 **DSC**（唱碟反復播放）時，本機將播放所選唱碟各曲目開始部分約 10 秒種的內容。當您正在使用多碟鐳射唱機反復播放時，本機將播放各唱碟第一首曲目開始部分約 10 秒種的內容。

1 選擇反復播放範圍。

請參閱第 11 頁反復播放。

2 按住 PAUSE/SCAN 約兩秒種選擇 SCAN。

DSCN（掃描曲目）或 **SCAN**（掃描唱碟）出現在顯示器中。本機將播放當前唱碟各曲目（或各唱碟第一首曲目）的前 10 秒種內容。

3 當您找到所需的曲目（或唱碟）時，按住 PAUSE/SCAN 約兩秒種關閉掃描功能。

曲目（或唱碟）將繼續播放。



注意

- 完成曲目或唱碟掃描後，正常的曲目播放將繼續進行。

暫停唱碟的播放

暫停功能可讓您暫時停止唱碟的播放。

1 按 PAUSE/SCAN 啓動暫停功能。

PAUSE 出現在顯示器中。本機暫停當前播放的曲目。

2 按 PAUSE/SCAN 關閉暫停功能。

播放將從暫停點起繼續進行。

音頻調整介紹

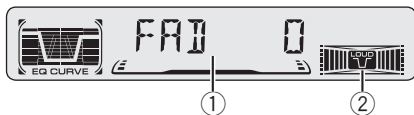

① 音頻顯示

顯示音頻調整的狀態。

② LOUD（響度）指示燈

打開響度功能時將顯示在顯示屏上。

按 **AUDIO** 顯示音頻功能的名稱。

反復按 **AUDIO** 可在下列音頻功能之間進行轉換：

FAD（衰減器）— **EQ-L**（等化器）— **LOUD**（響度）— **FIE**（前聲像增強器）— **SLA**（音源級調整）

- 當您選擇 FM 調諧器作為音源時，則不能轉換至 **SLA**。

若要返回各音源的顯示屏，請按 **BAND**。

注意

- 如果您在 30 秒鐘之內沒有操作音頻功能，則顯示屏自動返回音源顯示。▣

使用平衡調整

您可以選擇衰減 / 平衡設置，從而為全部座位上的欣賞者都創造出理想的聽音環境。

1 按 **AUDIO** 選擇 **FAD**。

按 **AUDIO** 直到顯示屏顯示 **FADER**。

- 如果此前已調整過平衡設置，則顯示 **BAL**。

2 按 **▲** 或 **▼** 調整前 / 後揚聲器的平衡。

按 **▲** 或 **▼** 可使前 / 後揚聲器平衡向前或向後移動。

- 當前 / 後揚聲器平衡由前向後移動時，顯示屏顯示 **FAD F15** — **FAD R15**。

- 如果僅使用兩隻揚聲器，正確的設置應為 **FAD0**。

3 按 **◀** 或 **▶** 調整左 / 右揚聲器的平衡。

當您按 **◀** 或 **▶** 時，顯示屏顯示 **BAL 0**。按 **◀** 或 **▶** 可使左 / 右揚聲器平衡向左或向右移動。

- 當左 / 右揚聲器平衡由左向右移動時，顯示屏顯示 **BAL L9** — **BAL R9**。▣

使用等化器

您可以利用等化器來調整等化，以使車內聲音特性符合您的要求。

調用等化器曲線

您可以隨時方便地調用本機儲存的六種等化器曲線。下面是等化器曲線表。

顯示	等化器曲線
SPR-BASS	超低音
POWERFUL	強勁
NATURAL	自然
VOCAL	唱聲
CUSTOM	定製
EQ FLAT	無效果

- **CUSTOM** 是一種由您建立的經調整的等化器曲線。
- 當選擇 **EQ FLAT** 時，本機不對聲音進行補充或修正。該功能在檢查等化器曲線的效果時十分有用，通過來回切換 **EQ FLAT** 和其他等化器曲線的方式對該等化器曲線的效果進行檢查。

按 EQ 選擇等化器。

- 如果此前已將等化器設置為 **POWERFUL** 以外的等化器曲線，則將顯示此前選擇的等化器曲線的標題，如 **SPR -BASS**、**NATURAL**、**VOCAL**、**CUSTOM** 或 **EQ FLAT**。□

調整等化器曲線

您可以根據需要調整當前選擇的等化器曲線設置。調整後的等化器曲線設置將儲存為 **CUSTOM**。

1 按 **AUDIO** 選擇等化器模式。

按 **AUDIO** 直到顯示屏顯示 **EQ-L/EQ-M/EQ-H**。

2 用 ◀ / ▶ 選擇您要調整的波段。

EQ-L (低) — **EQ-M** (中) — **EQ-H** (高)

3 按 ▲ 或 ▼ 調整等化器曲線。

按 ▲ 或 ▼ 可分別增加或減少等化器曲線。

- 當等化器曲線增加或減少時，顯示屏顯示 **+6 -- -6**。
- 實際的調整範圍因所選的等化器曲線而異。



注意

- 如果在選擇 **CUSTOM** 以外的其他曲線的情況下進行調整，則最新調整的曲線將替換—先前的曲線。此後選擇等化器曲線時，新的曲線將與 **CUSTOM** 一起在顯示屏中顯示。□

調整響度

響度調整可在低音量時對低音和高音範圍內的不足進行補償。

1 按 **AUDIO** 選擇 **LOUD**。

按 **AUDIO** 直到顯示屏顯示 **LOUD**。

2 用 ◀ / ▶ 啓動或關閉 **LOUD** 。

3 用選擇所需的音量。

LOW (低) — **MID** (中) — **HI** (高)



注意

- 您也可以通過按 **LOUDNESS** 啓動或關閉 **LOUD** 。 □

前聲像增強器 (FIE)

F.I.E. (前聲像增強器) 功能是一種簡單的增強前方聲像的方法：削減後置揚聲器的中高頻輸出並將輸出限制於低頻範圍。您可以選擇需削減的頻率。



注意事項

- 當關閉 F.I.E. 功能時，後置揚聲器將輸出全部頻率的聲音，而不僅是低音。在關閉 F.I.E. 之前請減小音量，以防音量突然增大。

1 按 **AUDIO** 選擇 **FIE** 。

按 **AUDIO** 直到顯示屏顯示 **FIE** 。

2 用 ▲ / ▼ 啓動或關閉 **FIE** 。

3 用 ◀ / ▶ 選擇所需的頻率。

100 — **160** — **250(Hz)**



注意

- 啓動 F.I.E. 功能後，請在音頻選單中選擇衰減 / 平衡模式，然後調整前後揚聲器音量使它們達到平衡。
- 如果使用雙揚聲器系統，則請關閉 F.I.E. 功能。 □

調整音源級

您可以利用 SLA (音源級調整) 功能調整各音源的音量級，以防止在音源之間進行轉換時音量發生突然的變化。

- FM 調諧器的音量級通常保持不變，此項設置即是以 FM 調諧器的音量級為基準。

1 將 **FM** 調諧器的音量級與您需要調整的音源的音量級相比較。

2 按 **AUDIO** 選擇 **SLA** 。

按 **AUDIO** 直到顯示屏顯示 **SLA** 。

3 按 ▲ 或 ▼ 調整音源音量。

按 ▲ 或 ▼ 增大或降低音源音量。

- 當音源音量增大或降低時，顯示屏顯示 **SLA+4** — **SLA-4** 。



注意

- 由於 FM 調諧器音量是控制基準，因此無法將音源級調整功能用於 FM 調諧器。
- AM 調諧器的音量級也可通過音源級調整功能進行調整。 □

初始設置

調整初始設置



您可以利用初始設置功能對本機的多種設置進行初始化設定。

1 按住 **SOURCE** 直到本機關閉。

2 按住 **AUDIO** 直到顯示屏顯示 **TIME**。

反復按 **AUDIO** 可在下列設置之間轉換：

TIME — FM STEP — AM STEP — AUX

根據下列說明進行各種設置。

- 若要取消初始設置，則按 **BAND**。
- 您還可以按住 **AUDIO** 直到本機關閉，以此來取消初始設置。◻

設置時間

該功能用於設置本機時鐘顯示屏上的時間。

1 按 **AUDIO** 選擇時間。

按 **AUDIO** 直到顯示屏顯示時間。

2 用 ◀ / ▶ 選擇需要設置的時間顯示部份。

按 ◀ / ▶ 可選擇時鐘顯示部份：

HOURL — MINUTE

當您選定時鐘顯示部分時，所選的部份將會閃爍。



3 用 ▲ / ▼ 選擇正確的時間。

按 ▲ 可增大所選的小時或分鐘。按 ▼ 可減小所選的小時或分鐘。◻

設置 FM 調諧幅度

FM 模式下的搜索調諧所採用的調諧幅度可在 100 kHz（出廠預設值）和 50 kHz 之間轉換。

1 按 **AUDIO** 選擇 **STEP**。

反復按 **AUDIO** 直到顯示屏顯示 **FM100**。

2 用 ◀ / ▶ 選擇 FM 調諧幅度。



注意

- 如果以 50 kHz 幅度執行搜索調諧，則搜索出來的某些電台可能會不太精確。請手動調諧這些電台或再進行一次搜索調諧。▣

設置 AM 調諧幅度

AM 調諧幅度可在 9 kHz（預設幅度）和 10 kHz 之間轉換。如果在北美洲、中美洲或南美洲使用調諧器，則請將調諧幅度從 9 kHz（允許範圍 531 - 1,602 kHz）重設為 10 kHz（允許範圍 530 - 1,640 kHz）。

1 按 **AUDIO** 選擇 **AM STEP**。

反復按 **AUDIO** 直到顯示屏顯示 **AM9**。

2 用 **◀ / ▶** 選擇 **AM 調諧幅度**。

按 **◀ / ▶** 可使 AM 調諧幅度在 9 kHz 和 10 kHz 之間轉換。所選的 AM 調諧幅度將顯示在顯示屏上。▣

切換輔助設置

您可以將輔助設備與本機配合使用。當您使用與本機相連的外部設備時，請執行輔助設置。

1 按 **AUDIO** 選擇 **AUX**。

反復按 **AUDIO** 直至 **AUX** 出現在顯示器中。

2 用 **▲/▼** 打開或關閉 **AUX**。

按 **▲/▼** 可切換 **AUX** 的打開和關閉，當前狀態將顯示。▣

將時間顯示設定為打開或關閉狀態

即使當音源處於關閉狀態，您也可以打開時間顯示。

按 **CLOCK**，選擇時間顯示。

每按一下 **CLOCK**，時間顯示即會打開或關閉。

- 當您執行其他操作時，時間顯示會暫時消失。但 25 秒後時間顯示會再次出現。▣

使用 **AUX** 音源

您可以使用 CD-RB20 或 CD-RB10 之類的 IP-BUS-RCA 接線（另售）將本機與配備 RCA 輸出端的輔助設備連接起來。詳情請參閱 IP-BUS-RCA 接線的使用說明書。

選擇 **AUX** 作為音源

按 **SOURCE** 選擇 **AUX** 作為音源。

按 **SOURCE** 直至 **AUX** 出現在顯示器中。

- 如果輔助設置沒有打開，則不能選擇 **AUX**。詳情請參閱本頁的切換輔助設置。▣

卡式磁帶

- 卡式磁帶上的標籤若有鬆動、撕裂或捲曲現象，可能會使卡式磁帶播放機發生夾帶。請勿使用具有鬆弛、撕裂或捲曲標籤的卡式磁帶。
- 長度大於 C-90（90 分鐘磁帶）的卡式磁帶可能會引起播放機夾帶現象。請勿使用長度大於 C-90 的磁帶。
- 卡式磁帶受高溫影響會發生翹曲，並導致播放機夾帶。請勿將卡式磁帶放置於直射陽光或高溫處。



- 將未用過的磁帶置於磁帶盒內，以免磁帶鬆弛、變髒或沾染灰塵。▣

清潔播放磁頭

如果磁頭變髒，音質就會變差，產生聲音失落等問題。如果發生此類問題，則表明可能需要清潔磁頭。

音樂搜索和反復播放功能

音樂搜索和反復播放功能可能不適用於下列磁帶：

- 曲子之間的時間不超過 4 秒的磁帶。
- 含有對話等非音樂內容，並且其中的暫停時間不少於 4 秒的磁帶。
- 所含音樂中有不少於 4 秒的靜默片斷的磁帶。▣

規格

一般

電源	14.4VDC (容許範圍 10.8 - 15.1V)
接地系統	負極型
最大電流消耗	10.0A
尺寸 (寬×高×深) (DIN)	機身 178 × 50 × 157 毫米 前端部分 .. 188 × 58 × 20 毫米
(D)	機身 178 × 50 × 162 毫米 前端部分 .. 170 × 46 × 15 毫米
重量	1.4 公斤

音頻

各聲道連續輸出功率	為 22 瓦，最小負荷 4 歐姆，聲道範圍 50 至 15,000Hz，儘 5%THD。
最大輸出功率	50W × 4
負載阻抗	4Ω (容許範圍 4 - 8Ω)
前輸出最大輸出電平 / 輸出阻抗	2.2V/1kΩ
等化器 (3 波段等化器) :	
(低頻)	等級：±12dB
(中頻)	等級：±12dB
(高頻)	等級：±12dB
響度等高線	
(低頻)	+3.5dB (100Hz) +3dB (10kHz)
(中頻)	+10dB (100Hz) +6.5dB (10kHz)
(高頻)	+11dB (100Hz) +11dB (10kHz) (音量：-30dB)

卡式磁帶播放機

磁帶	小型卡式磁帶 (C-30 - C-90)
走帶速度	4.8 cm/sec
快進 / 倒帶時間	約 100 sec (C-60)
抖晃度	0.09% (WRMS)
頻率響應	30-16,000Hz (±3dB)
立體聲分離度	45dB
信噪比	61dB (IEC-A 網路)

FM 調諧器

頻率範圍	87.5 - 108.0MHz
有效靈敏度	11dBf (1.1μV/75Ω, 單聲道, S/N: 30 dB)
50dB 靜噪靈敏度	17dBf (2.2μV/75Ω, 單聲道)
信噪比	58dB (IEC-A 網路)
失真	0.5% (65dBf, 1kHz, 立體聲)
頻率響應	30 - 15,000Hz (±3dB)
立體聲分離度	24dB (65dBf, 1kHz)

AM 調諧器

頻率範圍	531 - 1,602kHz (9kHz) 530 - 1,640kHz (10kHz)
有效靈敏度	20μV (S/N: 20dB)
選擇度	50dB (±9kHz) 50dB (±10kHz)

注意

- 規格和設計若因改進有所變更，恕不另行通知。□

PIONEER CORPORATION

4-1, MEGURO 1-CHOME, MEGURO-KU, TOKYO 153-8654, JAPAN

PIONEER ELECTRONICS (USA) INC.

P.O. Box 1760, Long Beach, California 90801, U.S.A.

TEL: (800) 421-1404

PIONEER EUROPE NV

Haven 1087, Keetberglaan 1, B-9120 Melsele, Belgium

TEL: (0) 3/570.05.11

PIONEER ELECTRONICS AUSTRALIA PTY. LTD.

178-184 Boundary Road, Braeside, Victoria 3195, Australia

TEL: (03) 9586-6300

PIONEER ELECTRONICS OF CANADA, INC.

300 Allstate Parkway, Markham, Ontario L3R OP2, Canada

TEL: (905) 479-4411

PIONEER ELECTRONICS DE MEXICO, S.A. de C.V.

San Lorenzo 1009 3er. Piso Desp. 302

Col. Del Valle Mexico, D.F. C.P. 03100

TEL: 5-688-52-90

先鋒股份有限公司

總公司：台北市中山北路二段44號13樓

電話：(02) 2521-3588

先鋒電子（中國）有限公司

香港辦事處：香港銅鑼灣告士打道280號世界貿易中心

17樓 1704-06室

電話：(0852) 2848-6488

Published by Pioneer Corporation.

Copyright © 2001 by Pioneer Corporation.

All rights reserved.

Publication de Pioneer Corporation.

Copyright © 2001 Pioneer Corporation.

Tous droits de reproduction et de traduction réservés.