

Thank you for choosing

Panasonic
Omnivision **D** **VHS** **MTP**
NTSC

Digital Video Cassette Recorder

MODEL PV-HD1000

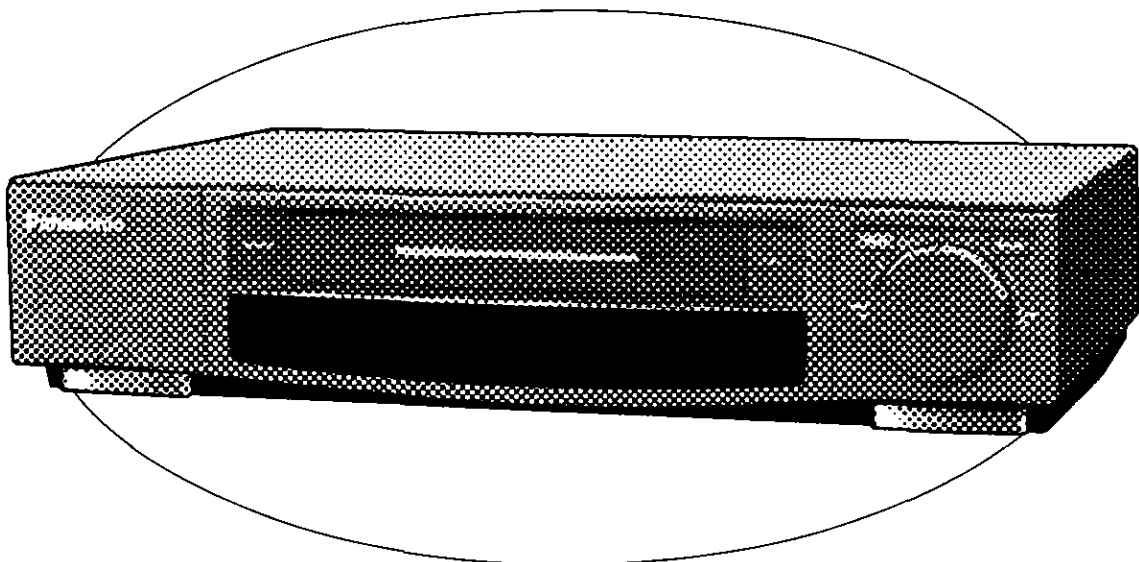

Operating Instructions



Please read these instructions carefully before attempting to connect, operate or adjust this product. Please save this manual.

Spanish Quick Use Guide is included. (Guía para rápida consulta en español está incluida.)

Quick Use Guide is on the back cover.

Basic Operation

Advanced Operation

For Your Information

Important Safeguards and Precautions

FOR YOUR SAFETY, READ AND RETAIN ALL SAFETY AND OPERATING INSTRUCTIONS. HEED ALL WARNINGS IN THE MANUAL AND ON THE UNIT

INSTALLATION

1 POWER SOURCE CAUTION

Operate only from a power source indicated on the unit or in this manual. If necessary, have your Electric Utility Service Company or Video Products Dealer verify the power source in your home.

2 POLARIZED OR GROUNDING PLUG

As a safety feature, this Video product comes with either a polarized power cord plug (one blade is wider than the other), or a three-wire grounding type plug.

POLARIZED PLUG CAUTION:

This plug will only fit into an outlet one way. If you cannot fully insert the plug, try reversing it. If it still will not fit, have an electrician install the proper wall outlet. Do not defeat the safety feature by tampering with the plug.

GROUNDING PLUG CAUTION:

This plug will only fit into a three-hole grounding outlet. If necessary, have an electrician install the proper outlet. Do not defeat the safety feature by tampering with the plug.

3 POWER CORD

Make sure power cords are routed so that they are not likely to have anything rest on them, roll over them, or be in the way of walking traffic.

If an extension cord is used, make sure it also has either a polarized or grounded plug and that the cords can be securely connected.

Frayed cords, damaged plugs, and damaged or cracked wire insulation are hazardous and should be replaced by a qualified service technician.

Overloaded outlets and extension cords are fire hazards and should be avoided.

4 DO NOT BLOCK VENTILATION HOLES

Ventilation openings in the cabinet release heat generated during operation. If they are blocked, heat build-up inside the unit can cause failures that may result in a fire hazard or heat damage to cassettes.

For protection, follow these rules:

- Never cover ventilation slots or the unit while in use, or operate the unit when placed on a bed, sofa, rug, or other soft surface.
- Avoid built-in installation, such as a book case or rack, unless proper ventilation is provided.

5 AVOID EXTREMELY HOT LOCATIONS OR SUDDEN TEMPERATURE CHANGES

Do not place the unit over or near any kind of heater or regulator, in direct sunlight, inside a closed vehicle, etc. Do not move the unit suddenly between areas of extreme temperature variation. If the unit is suddenly moved from a cold place to a warm place, moisture may condense in the unit and on the tape.

6 TO AVOID PERSONAL INJURY

- Do not place unsecured equipment on a sloping surface.
- Do not place this unit on any support that is not firm, level, and adequately strong. The unit could fall causing serious injury to a child or adult and damage to the unit.
- An appliance and cart combination should be moved with care. Quick stops, excessive force, and uneven surfaces may cause the appliance and cart combination to overturn.
- Carefully follow all operating instructions and use the manufacturer's recommended accessories when operating this unit or connecting it to any other equipment.



Safety Precautions

Warning: To prevent fire or shock hazard, do not expose this equipment to rain or moisture.

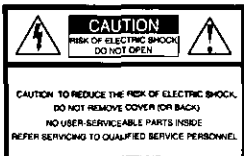

This symbol warns the user that uninsulated voltage within the unit may have sufficient magnitude to cause electric shock. Therefore, it is dangerous to make any kind of contact with any inside part of this unit.



This symbol alerts the user that important literature concerning the operation and maintenance of this unit has been included. Therefore, it should be read carefully in order to avoid any problems.

OUTDOOR ANTENNA INSTALLATION

1 SAFE ANTENNA AND CABLE CONNECTION

If an outside antenna or cable system is connected to the equipment, be sure the antenna or cable system is grounded so as to provide some protection against built up static charges and voltage surges.

Section 810 of the National Electrical Code, ANSI/NFPA 70 (in Canada, part 1 of the Canadian Electrical Code) provides information with respect to proper grounding of the mast and supporting structure, grounding of the lead-in wire to an antenna discharge unit, size of grounding conductors, location of antenna discharge unit, connection to grounding electrodes and requirements for the grounding electrode.

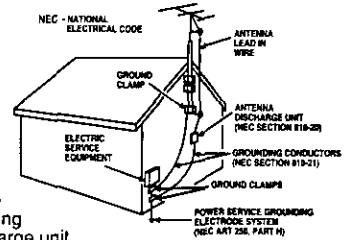

2 KEEP ANTENNA CLEAR OF HIGH VOLTAGE POWER LINES OR CIRCUITS

An outside antenna system should be located well away from power lines, electric light or power circuits and where it will never come into contact with these power sources if it should happen to fall. When installing an outside antenna, extreme care should be taken to avoid touching power lines, circuits or other power sources as this could be fatal. Because of the hazards involved, antenna installation should be left to a professional.

USING THE VIDEO UNIT

If the unit has been in storage or moved to a new location, refer first to the INSTALLATION section of these safeguards.

1 KEEP THIS VIDEO UNIT AWAY FROM WATER OR MOISTURE OF ANY KIND.

2 IF EQUIPMENT IS EXPOSED TO RAIN, MOISTURE, OR STRONG IMPACT, unplug the unit and have it inspected by a qualified service technician before use.

3 DURING AN ELECTRICAL STORM

During a lightning storm, whether indoors or outdoors, or before leaving the unit unused for extended periods of time, disconnect all equipment from the power source as well as the antenna and cable system.

4 WHEN THE UNIT IS PLUGGED IN

- Never expose the unit to rain or water. DO NOT OPERATE if liquid has been spilled into the unit. Immediately unplug the unit, and have it inspected by a service technician. Fire and shock hazards can result from electrical shorts caused by liquid contact inside.
- Never drop or push any object through openings in the unit. Some internal parts carry hazardous voltages and contact can cause electric shock or fire hazard.
- Avoid placing the unit directly above or below your TV set as this may cause electrical interference. Keep all magnets away from electronic equipment.

5 USING ACCESSORIES

Use only accessories recommended by the manufacturer to avoid risk of fire, shock, or other hazards.

6 CLEANING THE UNIT

Unplug the unit. Then, use a clean, dry, chemically untreated cloth to gently remove dust or debris. DO NOT USE cleaning fluids, aerosols, or forced air that could over-spray, or seep into the unit and cause electrical shock. Any substance such as wax, adhesive tape, etc. may mar the cabinet surface. Exposure to greasy, humid, or dusty areas may adversely affect internal parts.

SERVICE

1 DO NOT SERVICE THIS PRODUCT YOURSELF

If, after carefully following the detailed operating instructions, this Video product does not operate properly, do not attempt to open or remove covers, or make any adjustments not described in the manual. Unplug the unit and contact a qualified service technician.

2 IF REPLACEMENT PARTS ARE REQUIRED

Make sure the service technician uses only parts specified by the manufacturer, or those having the same safety characteristics as the original parts. The use of unauthorized substitutes may result in fire, electric shock, or other hazards.

3 HAVE THE SERVICE TECHNICIAN PERFORM A SAFETY CHECK

After any service or repairs to the unit, request the service technician to conduct a thorough safety check as described in the manufacturer's service literature to insure that the video unit is in safe operating condition.

Table of Contents

Use
Now!

Important Safeguards and Precautions	2
Accessories	4
Loading the Batteries	4
Introduction about D-VHS	5
Basic Connection (Antenna, D-VHS VCR, DTV Compatible TV)	6, 7
Advanced Connections	8, 9
One Time D-VHS VCR Setup	10 ~ 14
(Cable Box/ DSS Receiver Setup, Channel Memory, Auto Clock Set)	
VHS Playback	15
(Slow Motion, Still Picture, Frame'by Frame, Features for a Quality)	
VHS Recording	16, 17
• One Touch Timer Recording	16
• Selecting the Input Mode	17
• Recording One Program While Watching Another	17
• Selecting Channels at the D-VHS VCR	17
D-VHS (Digital) Playback	18
• Still (Freeze) Frame Picture	18
D-VHS (Digital) Recording	19
• One Touch Timer Recording	19

Basic Operation

Enjoy
more!

Timer Recording	20, 21
VCR Plus+ System Setup	22
VCR Plus+ System Programming	23
Multi-Brand Control Feature	24, 25
MTS Broadcast / VHS Hi-Fi Stereo System	26, 27
Tape Operation	28 ~ 30
• VHS Index Search	28
• Index Scan	29
• Shuttle Variable Speed Search	29
• Repeat Play	30
• One Minute Skip	30
• Zero Search	30
Copying Your Tapes (Dubbing)	31
Special VCR Features	32
• VCR Lock	32
• Weak Signal Display	32
• Warning Beeper	32

Advanced Operation

Other
Information!

Reset Channel, Clock	33
D-VHS VCR & Cassette Information	34, 35
• Reset all D-VHS VCR Memory Functions	34
• D.S.T. (Daylight Saving Time)	34
• To prevent accidental erasure a recorded tape	34
• Record / Playback Time	34
• Head Cleaner	35
• Cleaning the D-VHS VCR	35
• Declaration of Conformity	35
• Specifications	35
On-Screen Displays (OSD)	36
• Function & Channel Display	36
• Menu Screen	36
• VCR Status & Clock Display	36
• Blank Tape/No Video Signal Indication	36
• Warning and Instruction Displays	36
Before Requesting Service	37
Service Center List	38
Warranty	39
Spanish Quick Use Guide/Guía para rápida consulta	40 ~ 45
Location of Controls	46, 47
• Remote Control	46
• Front View of the D-VHS VCR	46
• Multi Function Display	47
• Rear View of the D-VHS VCR	47
Quick Use Guide	Back Cover

For Your Information

Before Using

Congratulations

on your purchase of one of the most sophisticated and reliable products on the market today. Used properly, it will bring you and your family years of enjoyment. Please fill in the information at right. The serial number is on the tag located on the back of your D-VHS VCR.

•Date of Purchase _____
•Dealer Purchased From _____
•Dealer Address _____
•Dealer Phone No. _____
•Model No. _____
•Serial No. _____

Accessories

- Light Tower® Universal Remote Control VSQS1578

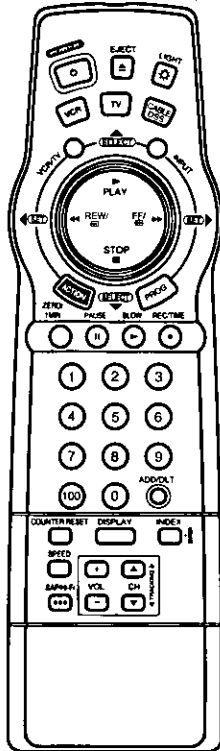

- 4 "AA" Batteries

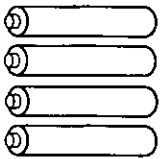

- RF Coaxial Cable VJAS0184



- IEEE1394 Cable VJAS0217

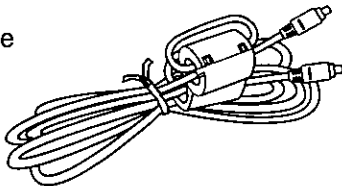

- D-VHS Cassette tape DF-300

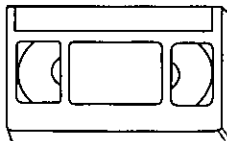

To order accessories, call toll free 1-800-332-5368.

Loading the Batteries

- 1 Press down on the ►► mark and slide the Battery Compartment lid open.

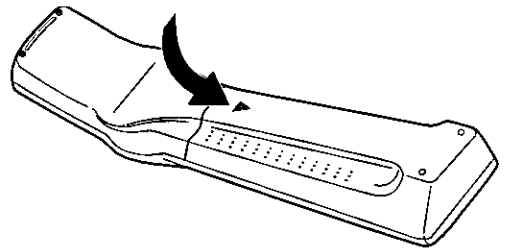

- 2 Install four batteries as indicated inside the Battery Compartment.

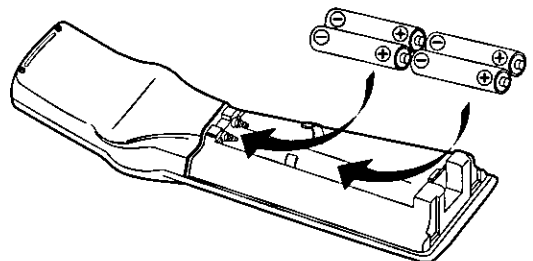

- 3 Slide the Battery Compartment lid back into place.

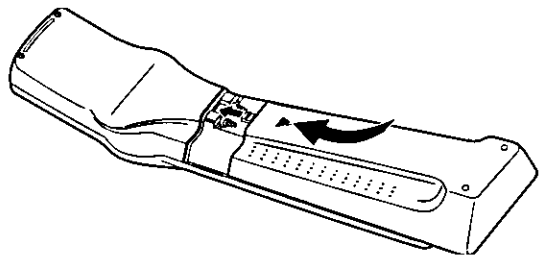

Battery replacement caution

- Do not mix old and new batteries.
- Do not mix alkaline with manganese batteries.

Introduction about D-VHS

ABOUT D-VHS

The "D" in D-VHS represents Digital Data. As this name suggests, D-VHS is an extension of the world's most popular VHS home video format, which adds new digital recording (storage) capabilities that make it an ideal match for digital broadcasts.

Like VHS, D-VHS is a tape-based format. Unlike VHS, D-VHS records digital signals as a digital bit stream (data) which is compatible with the MPEG II and ATSC standards utilized by your broadcast system.

Since digital data is stored "as is", there is no loss of quality compared to the original broadcast.

And since you will want to continue enjoying all of the regular VHS tapes you've recorded or accumulated, the D-VHS also offers conventional analog (VHS) recording and playback in addition to digital.

The relationship between type of broadcast, cassette D-VHS Switch, and resulting recording is as follows:

Broadcast	Cassette	D-VHS Switch	Recording
Digital Broadcast	D-VHS	HS or HS/STD	D-VHS (bit stream)
Digital Broadcast	VHS	HS or HS/STD or ANALOG	VHS (analog)
Local	D-VHS	HS or HS/STD or ANALOG	VHS (analog)
Local	VHS	HS or HS/STD or ANALOG	VHS (analog)

PRODUCT FEATURES

FEATURES		VHS Mode	D-VHS Mode
REC SPEED		SP/LP/SLP	HS/STD
Hi-Fi		YES	—
MTS/SAP		YES	—
VCR Plus+		YES	—
MULTI-BRAND CONTROL		YES	—
SQPB (Super VHS Quasi Playback)		YES	—
ON-SCREEN DISPLAY		YES	— *1
181-CHANNEL TV/CATV TUNER		YES	—
VCR LOCK/WARNING BEEPER		YES	YES
TAPE OPERATION	REC/PLAYBACK/REW/FF/STILL	YES	YES
	SEARCH (CUE/REV)	YES	— *2
	SHUTTLE SEARCH	YES	—
	SLOW/FRAME ADVANCE	YES	—
	INDEX SEARCH	YES	YES *3
	ZERO SEARCH	YES	YES
	1-MINUTE SKIP	YES	YES
	REPEAT PLAY	YES	YES
	ONE TOUCH RECORDING	YES	YES *4
	TIMER RECORDING	YES	YES *5

*1: There is no on-screen display during digital playback.

*2: The picture will be frozen during this operation.

*3: Digitally recorded tapes will have no on-screen displays.

*4: One touch recording is not functional when recording from a Set Top Box.

*5: For DTV timer program, tune the Set Top Box to the desired program, then it ON.

Basic Connection

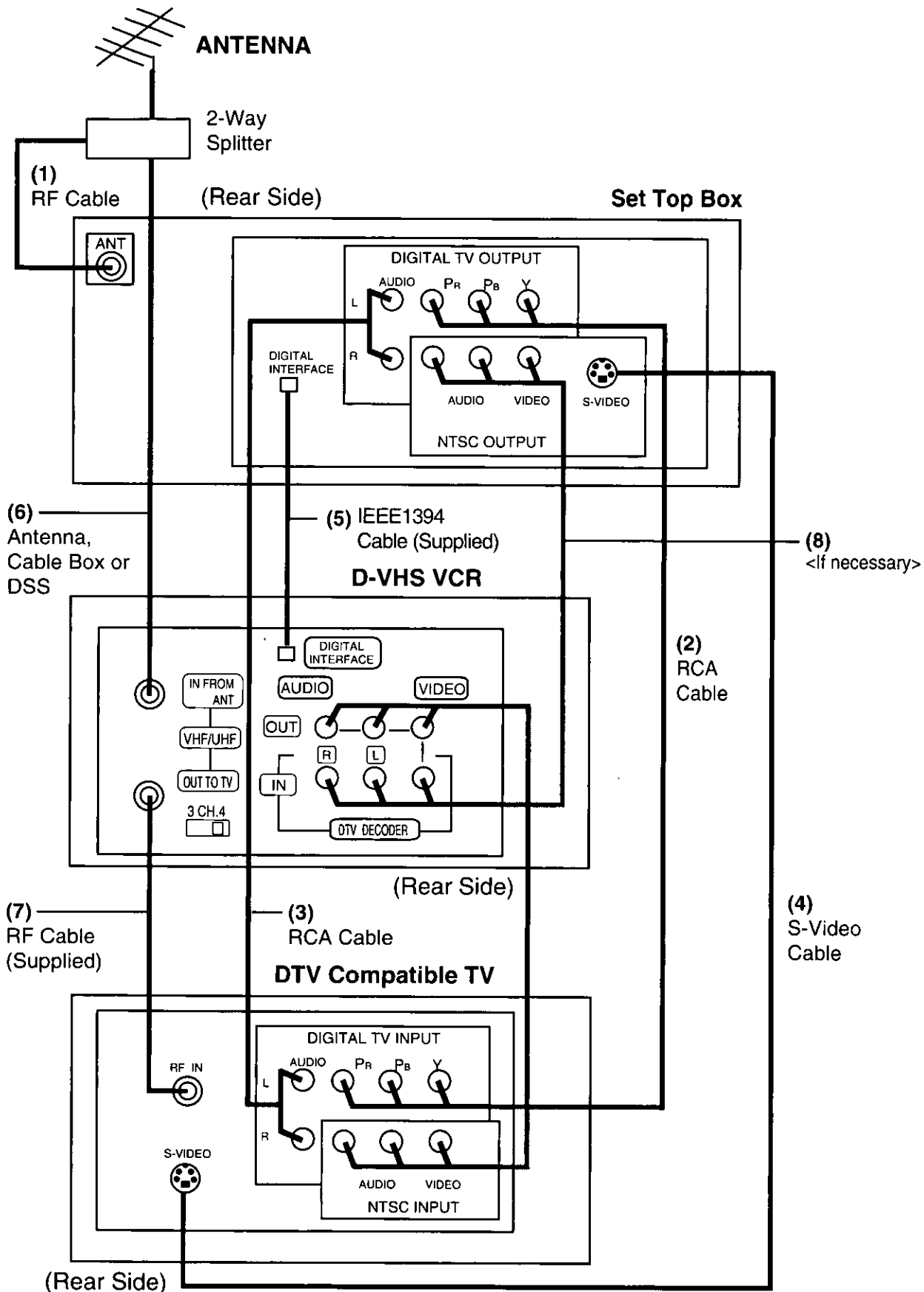

Explanations for Each Connection

(1) ANT (Set Top Box)

Connects the broadcast signal from your home antenna to receive Digital broadcasts. To connect the broadcast signal to the D-VHS VCR, use a 2-Way Splitter (not supplied).

(2) Y, P_B, and P_R Jacks (Set Top Box)

Connects to Y, P_B, and P_R jacks on the Digital TV with RCA type cable to see digital broadcasts and digital playback programs from the D-VHS VCR.

(3) AUDIO L/R OUT Jacks (Set Top Box)

Connects to AUDIO L/R IN on the Digital TV to listen to Audio sound from the Set Top Box. Y, P_B, P_R, and S-VIDEO jacks do not contain an audio signal. You cannot hear the audio sound if these jacks are connected to the Digital TV.

(4) S-Video (Set Top Box)

Connects to S-VIDEO on the Digital TV to see a high quality picture with NTSC.

(5) DIGITAL INTERFACE Jacks (Set Top Box)

Connects to DIGITAL INTERFACE jack on the D-VHS VCR with IEEE1394 Cable (Supplied) to record and playback digital broadcasts.

- If IEEE1394 HUB is used, the D-VHS VCR may not operate correctly.
- The IEEE1394 cable may not be compatible for connection with other brand Set Top Boxes.
- Digital playback and digital recording with the D-VHS VCR is only possible if the signal is based on MPEG 2 format.

Even with the D-VHS VCR connected to a DVC (digital video camera) with an IEEE1394 Digital Interface cable, the D-VHS VCR cannot do a digital recording of the DVC playback, nor can the DVC do a digital recording of the D-VHS VCR Playback.

(6) IN FROM ANT. Jack (D-VHS VCR)

Connects Antenna or Cable Box or DSS signal.

(7) OUT TO TV Jack (D-VHS VCR)

Connects to RF IN on the Digital TV with RF Cable (Supplied).

(8) AUDIO/VIDEO OUT (Set Top Box) <If necessary>

Connects to AUDIO/VIDEO IN on the D-VHS VCR with RCA type cable to receive an analog signal from the Set Top Box. Use this connection to record a digital broadcast in VHS format with DTV selected as the input mode.

CAUTION: The D-VHS VCR should only be used with a Panasonic Set Top Box as other brands may not function properly.



If you connect the DIGITAL OUTPUT on the Set Top Box to the DIGITAL INPUT on the DTV compatible TV only, or the NTSC OUTPUT on the Set Top Box to the AUDIO/ VIDEO IN on the DTV compatible TV only, some on screen displays such as MENU or PROGRAM will not be displayed.

- When "ACT" or "PRG" is displayed in the Multi Function Display, press ACTION or PROG to exit the MENU or PROGRAM mode in order to operate the PLAY, STOP, REWIND, and FF buttons.

Advanced Connections

Between Antenna and D-VHS VCR

Case 1: Twin Lead Cable Only

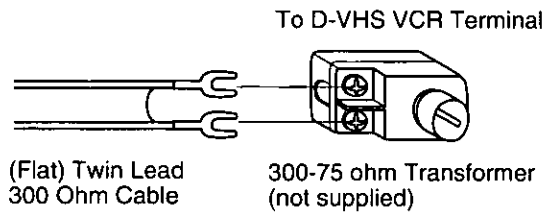

Case 2: Twin Lead & Coaxial Cables

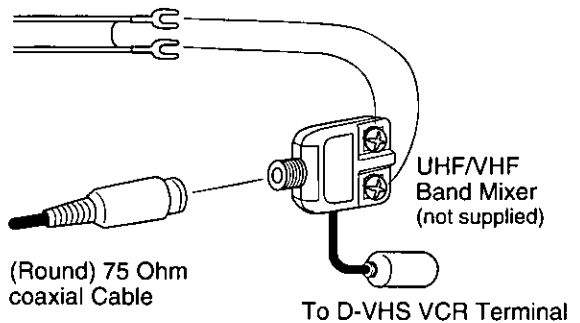

Between D-VHS VCR and TV

Case 1: Screw & Plug Type Terminal

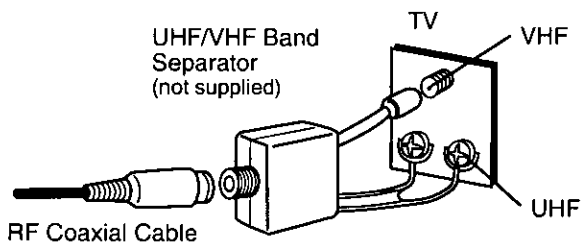

Case 2: Screw Type Terminal

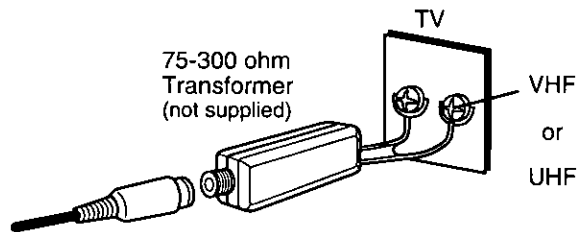

CATV Connection

All connections on these pages are made with 75 Ohm coaxial cables.

With a Cable Box (Cable Box → D-VHS VCR)

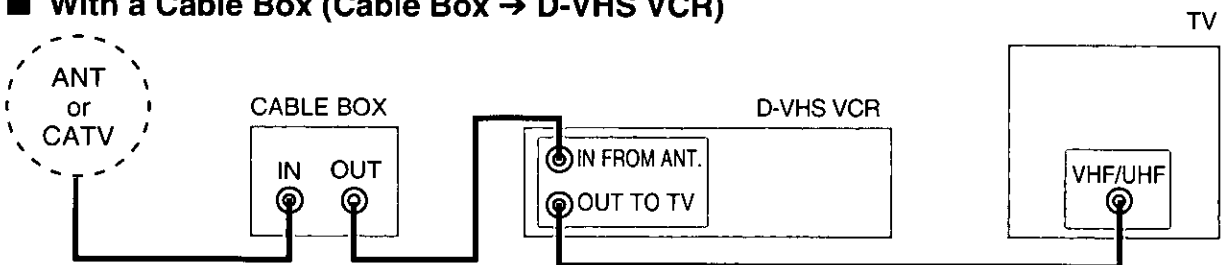

With a Cable Box (D-VHS VCR → Cable Box)

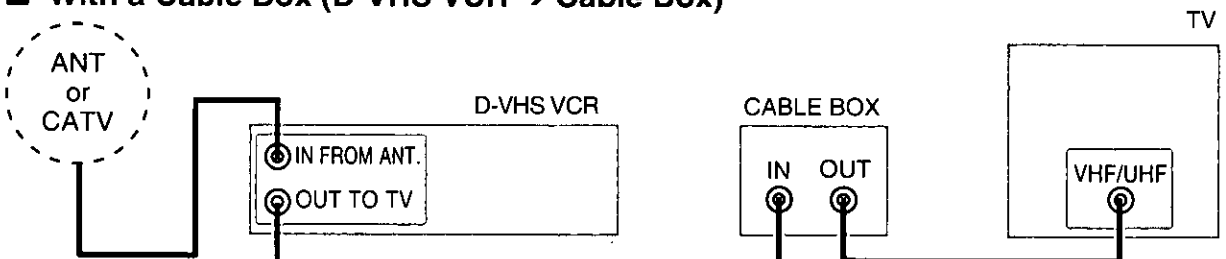

Case 3: Two Twin Lead Cables

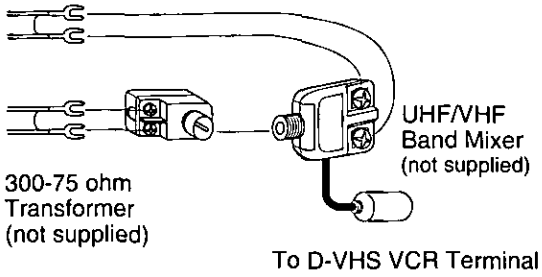

Case 3: Double Screw Type Terminal

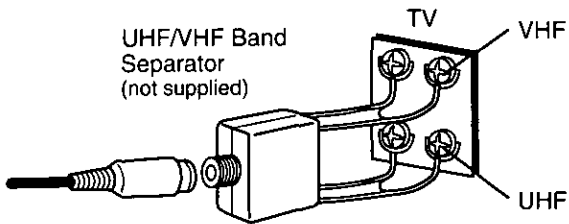

Case 4: Complex TV Terminal

TERMINALS ON BACK OF TV SET

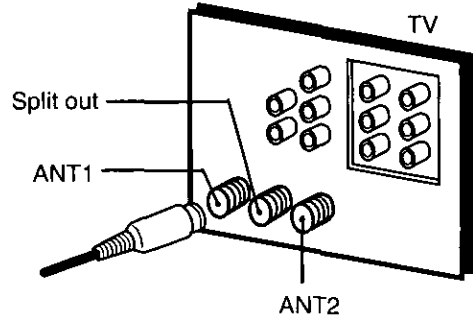

You Can

You Cannot

- record or view any (including scrambled) channel.
- use D-VHS VCR Remote Control to select channels using Multi-brand control feature.

- view channel other than the one selected for any type of recording.
- do a Timer recording of a channel unless you select it at the cable box.

- view any (including scrambled) channel.
- use D-VHS VCR Remote Control to select channels without using Multi-brand control feature.

- record scrambled channels.

Note to CABLE system installer:

This reminder is provided to call the CABLE system installer's attention to Article 820-40 of the NEC in USA (and to the Canadian Electrical Code in Canada) that provides guidelines for proper grounding and, in particular, specifies that the cable ground shall be connected to the grounding system of the building, as close to the point of cable entry as practical.

- Cassettes marked **DVHS** and **VHS** can be used with this video cassette recorder. However, D-VHS recordings are possible only with cassettes marked **DVHS**.
- HQ VHS is compatible with existing VHS equipment.

One Time D-VHS VCR Setup

The setup on pages 12 through 14 is vital for proper D-VHS VCR operation. Please read the instructions carefully and in the order presented.

NOTE: These first two pages contain reference material needed for setup on pages 12 - 14. Please look over the information before you begin setup procedure.

Setup Overview

You will be performing the following tasks:

- Telling the D-VHS VCR what kind of equipment you are using to receive channels and how it is connected.
- Entering pertinent cable box or DSS receiver information if used.
- Entering a local PBS channel so that the D-VHS VCR can receive auto clock set data. (Not available in all areas.)
- Placing channels in memory and setting the clock.

Please Note Which Connection Type You are Using.

Make sure all equipment is hooked up as described on pages 6 - 11. The diagrams below illustrate some of the basic connection types. Confirm which type you used for later reference.

Connection Type A

<CABLE BOX → D-VHS VCR → TV>

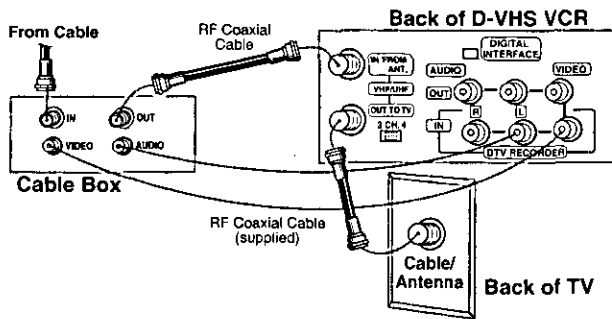

Or, <ANT/CABLE BOX → DSS BOX → D-VHS VCR → TV>

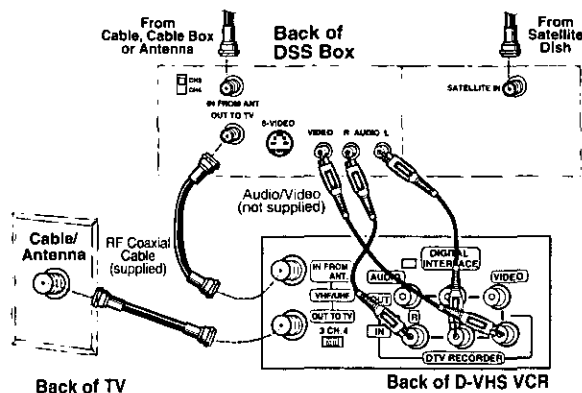

Connection Type B

<D-VHS VCR → TV>

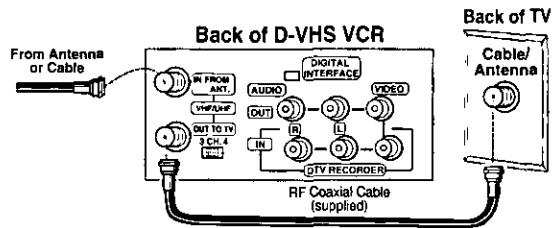

Or, <D-VHS VCR → CABLE BOX → TV>

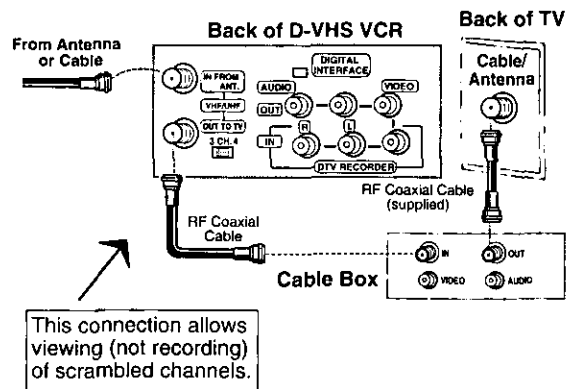

ONE TIME SETUP IMPORTANT NOTES:

- For detailed DSS receiver connection instruction, please see your DSS operating manual.
- The DSS receiver must be turned off to view programs from the cable box or antenna.
- If you use a DSS receiver, it must be turned off for auto clock set.
- If your cable box is not remote controllable, it must be tuned to your PBS channel.
- If you use Audio/Video Jack connection between the D-VHS VCR and cable box or DSS receiver, you must also connect the RF coaxial cable in order to use the auto clock set and channel auto set features.

Cable Box/ DSS Receiver Code Number List

If your cable box or DSS receiver is remote controllable, refer to this list during setup on page 12. However, it will not operate all Cable Boxes or DSS Boxes made by these manufacturers. If you get no results, your particular product brand cannot be controlled by this remote control.

Cable Box

Brand	Code Numbers
Archer	01, 29, 44, 88, 91
Cableview	04, 30, 42, 44, 52, 63, 85, 88
Citizen	04, 30, 42, 44, 52, 63, 85, 88
Curtis	08, 09, 56, 61, 87, 90
Diamond	01, 29, 44, 88, 91
Drake	37, 67, 71
Eagle	13, 20, 22, 26, 40, 58, 62, 98
Eastern	28
GC Brand	04, 30, 42, 44, 52, 63, 85, 88
Gemini	04, 85
General Electric	57
General Instruments	
.....01, 02, 03, 04, 34, 55, 83, 85, 91, 93, 95	
Hamlin	14, 15, 28, 41, 97, 100, 102
Hitachi	31, 79
Jerrold	
.....01, 02, 03, 04, 34, 55, 83, 85, 91, 93, 95	
Macom	31, 79
Magnavox	25, 26
Matsushita	16, 17, 101
Movietime	29, 32, 38, 39, 40, 42, 44, 88
NSC	32, 38, 40
Oak	10, 11, 46, 99
Panasonic	16, 17, 101
Philips	13, 20, 23, 24, 96
Pioneer	05, 06, 78
Pulsar	04, 30, 42, 44, 52, 63, 85, 88
Radio Shack	44
RCA	16, 17, 101
Realistic	44, 51, 88
Regal	14, 41
Regency	28
Rembran	29, 32, 39, 42, 44, 88
Salora	68, 72
Samsung	32, 40, 42, 78, 94
Scientific Atlanta	08, 09, 56, 61, 87, 90
Sheritech	27
SL Marx	32, 40, 42, 78, 94

Brand	Code Numbers
Spucer	16, 17, 101
Stargate	
.....04, 30, 32, 40, 42, 44, 52, 63, 78, 85, 88, 94	
Sylvania	19
Teknika	74
Telecaption	77, 92
Televue	32, 40, 42, 78, 94
Texscan	18, 19
Tocom	01, 33, 34, 42, 48, 49, 91
Toshiba	36
Uniden Satellite	65, 69
Unika	01, 29, 44, 88, 91
Universal	42, 43, 44, 52, 63, 88
Viewstar	13, 20, 22, 26, 40, 58, 62, 98
Videoway	07, 23, 50
Vid Tech	64
Vidter	64
Zenith	07, 23, 50

DSS (Digital Satellite System Receiver)

Toshiba	103
Hitachi/ Hughes	104
Magnavox/ Uniden 1	105
Magnavox/ Uniden 2	106
Sony	107
RCA	108
Panasonic	109

Note: During setup you will be instructed to enter your brand code number. As some brands have multiple codes, it may be necessary to try different codes to attain the proper results. These codes are for Cable box or DSS Box setup for Auto Clock and VCR Plus+ recording only. For TV/Cable Box Multi-Brand Control operation, please see page 24.

Positioning Your Cable Box or DSS Receiver

If your cable box or DSS receiver is remote controllable, place it on or near the D-VHS VCR as shown in the example below. The D-VHS VCR transmits an infrared signal from two locations. Be sure not to cover the transmitter windows.

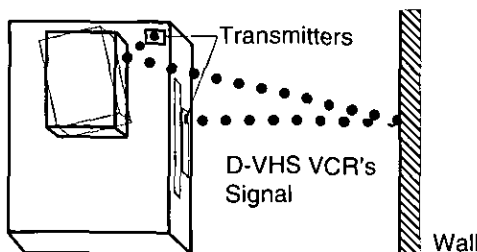

One Time D-VHS VCR Setup (continued)

***Important:** If the remote control POWER, ACTION, PROG, CH▲/▼, INDEX or ADD/HLT button does not work when pressed, press the VCR button on the remote and try the button again.

When the D-VHS VCR is turned on for the first time, it automatically enters the setup mode.

Setup includes the following:

- Tell the D-VHS VCR how your equipment is hooked up (pages 6-11) so the D-VHS VCR can correctly place channels into memory.
- Get the D-VHS VCR ready for clock set.

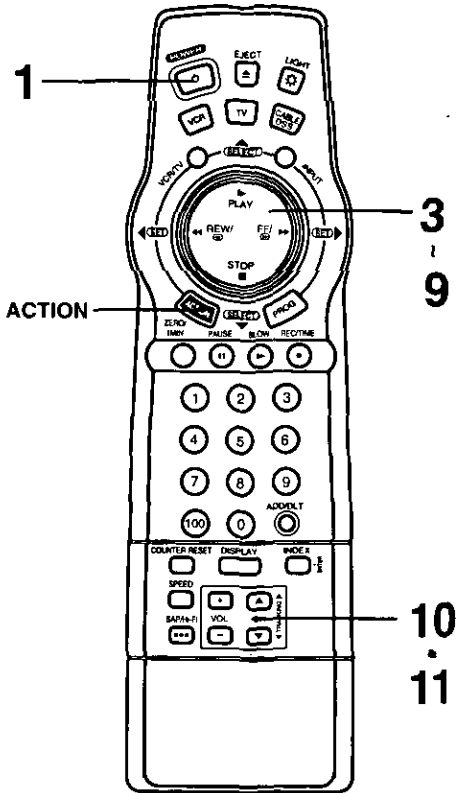
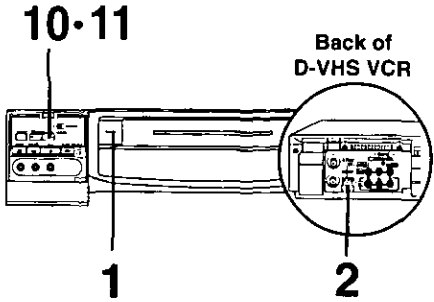

Using ▲▼◀▶ keys

When a MENU or PROGRAM screen is displayed, the PLAY, STOP, REWIND, and FF buttons on the remote control function as ▲▼◀▶ only.



To Set the Cable/DSS Receiver, Channels and Auto Clock Set

1 Turn the TV and D-VHS VCR on.*

2 Tune your TV to the D-VHS VCR output channel

(the same one you set on the back of the D-VHS VCR: CH3 or CH4).

- If you used audio/video jack connection, tune the TV to its video input.

3 Press ▲▼ to select your connection type, and then press ▶ to set.

- If you use a cable box or DSS receiver and selected "YES", go to step 4.
- If you selected "NO", "CABLE BOX CONTROL IS NOT AVAILABLE" is displayed. Go to "Alternate Instructions" on page 14.

ARE YOU USING A CABLE BOX OR DSS RECEIVER?

YES
NO

SELECT: ▲ ▼ KEY
SET : ▶ KEY
END : ACTION KEY

4 Press ▲▼ to select your hookup, and then press ▶ to set.

- If you selected "CABLE/DSS BOX ▶ VCR ▶ TV," continue with step 5. If not, go to "Alternate Instructions" on page 14.
- If you are using the CABLE/DSS BOX ▶ VCR ▶ TV connection method, only the cable box output channel will be placed in memory.

SELECT HOOKUP
CABLE/DSS BOX ▶ VCR ▶ TV
VCR ▶ CABLE/DSS BOX ▶ TV

SELECT: ▲ ▼ KEY
SET : ▶ KEY
END : ACTION KEY

5 Press ▲▼ to select your cable box or DSS receiver output channel number, and then press ▶ to enter.

- If necessary, refer to your cable box manual.
- If both a cable box and DSS receiver are used, set the output channel of the DSS receiver.
- If you are using Audio/Video jack connections to your cable box, select and set "VIDEO OUT" as the output channel.

SELECT HOOKUP
CABLE/DSS BOX ▶ VCR ▶ TV

CABLE/DSS BOX OUTPUT CH
CH 01

SELECT: ▲ ▼ KEY
SET : ◀ ▶ KEY
END : ACTION KEY

6 Press ▲▼ to select your cable box or DSS receiver code number, and then press ▶ to enter. (Refer to the list on page 11.)

- If your cable box or DSS receiver doesn't have a remote control, select "NO REMOTE." Then, go to Alternate Instructions on page 14.
- This determines whether the D-VHS VCR will control your cable box or DSS receiver.

ENTER CODE NUMBER
REFERRING TO MANUAL

01

SELECT: ▲ ▼ KEY
SET : ▶ KEY
END : ACTION KEY

Continued on the next page.

If you use a cable box, tune it to channel 02.
If you use a DSS receiver, tune it to channel 270.

7 Press **▶** to continue.
• "NOW TRANSMITTING" appears.

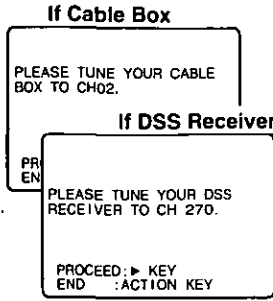

8 Press **▲▼** to select "YES" or "NO," and then press **▶** to enter.

If you use a cable box and selected "YES," go to step 9.

If you use a DSS receiver and selected "YES," go to "Alternate Instructions" on page 14.

If you selected "NO," the screen in step 6 on page 12 will reappear.

Try entering a different code assigned to your brand and/or repositioning the equipment (see page 11).

If the answer is still "NO," cable box or DSS receiver control is not available.

For channel and clock auto set, press **ACTION** to display the "SET UP CHANNEL" screen. Then, press **▲▼** to select "AUTO SET." Now, press **▶** and **CH ▲** to start the auto set.

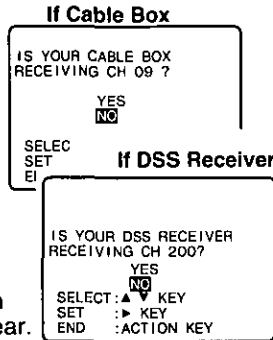

Confirm that your cable box is on and that your DSS receiver is off.

9 Press **▲▼** to select your local PBS channel number you receive on your cable box, and then press **▶** to display the "CLOCK AUTO SET" screen.

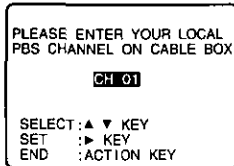

10 Press **CH ▲** to start Auto Clock Set.

- If you live near a different time zone, be sure to enter the PBS channel in your time zone.
- "AUTO CLOCK SET PROCEEDING" appears.

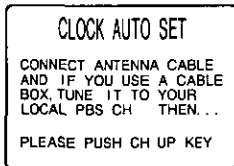

11 This display appears when auto clock set is completed.

Confirm that the time is correct and press **CH ▲** to exit.

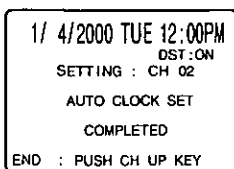

If the Auto Clock Set displayed time is incorrect...

If you use a cable box and receive more than one PBS station, try auto clock set again.
Follow the "To Set or Reset the Clock" section on page 33 and when the instructions call for you to enter a PBS station, enter the one you have not tried yet.

If "AUTO CLOCK SET IS INCOMPLETE" appears...

The screen below will appear on-screen if auto clock set data is not available in your area.

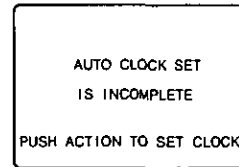

Press **ACTION** to display the "SET CLOCK" (manual) screen, and then do steps B and C on page 14.

Note:
If you use a cable box and receive more than one PBS station, you may exit the manual clock set screen and try auto clock set again.
Follow the "To Set or Reset the Clock" section on page 33 and when the instructions call for you to enter a PBS station, enter the one you have not tried yet.



- Auto clock set will be performed when the D-VHS VCR is turned off the first time each day. If you use a cable box and you want auto clock set to be performed, the cable box must be left on and tuned to the PBS channel before the D-VHS VCR power is turned off.
- It is necessary to set PBS CHANNEL to perform Auto clock set.

One Time D-VHS VCR Setup (continued)

***Important:** If the remote control POWER, ACTION, PROG, CH▲▼, INDEX or ADD/HLT button does not work when pressed, press the VCR button on the remote and try the button again.

Alternate Instructions

Complete the following steps if, any of the following applies:

- You selected "NO" in step 3 on page 12.
- You selected "VCR▶CABLE/ DSS BOX▶TV" in step 4 on page 12.
- You selected "NO REMOTE" in step 6 on page 12 (your cable box or DSS receiver is not remote controllable).
- You use a DSS receiver and selected "YES" in step 8 on page 13.

1 Turn on the cable box and set it to the local PBS channel.

- If you live near a different time zone, make sure to set the channel in your time zone.
- If you use a DSS receiver, it must be turned off.

CHANNEL/CLOCK AUTO SET
CONNECT ANTENNA CABLE AND IF YOU USE A CABLE BOX, TUNE IT TO YOUR LOCAL PBS CH THEN...
PLEASE PUSH CH UP KEY

2 Press CH ▲* to start Channel Auto Set and Auto Clock Set.

- The following messages appear.
"CH AUTO SET PROCEEDING"
"AUTO CLOCK SET PROCEEDING"

This screen appears to confirm that auto clock set is completed.

3 Confirm that the time is correct and press CH ▲ to exit.

If this screen appears, auto clock set is not available in your area. Please set the clock manually as described below.

1/ 4/2000 TUE 12:00PM
DST:ON
SETTING : CH 02
AUTO CLOCK SET
COMPLETED
END : PUSH CH UP KEY

AUTO CLOCK SET
IS INCOMPLETE
PUSH ACTION TO SET CLOCK

A Press ACTION to display the SET CLOCK screen.

SET CLOCK
DST:ON
SELECT MONTH
SELECT:▲▼ KEY
SET :▶ KEY
END :ACTION KEY

B Press ▲▼ and ◀▶ to select and set the month, date, year, time, and DST. (Daylight Saving Time).

To Make Corrections, repeatedly press ◀▶ to move the cursor to the incorrect entry and make the correction.

C Press ACTION twice to start the clock and exit this mode.

SET CLOCK
1/ 4/2000 TUE 12:00PM
DST:ON
SET COMPLETED
SET :◀▶ KEY
START :ACTION KEY

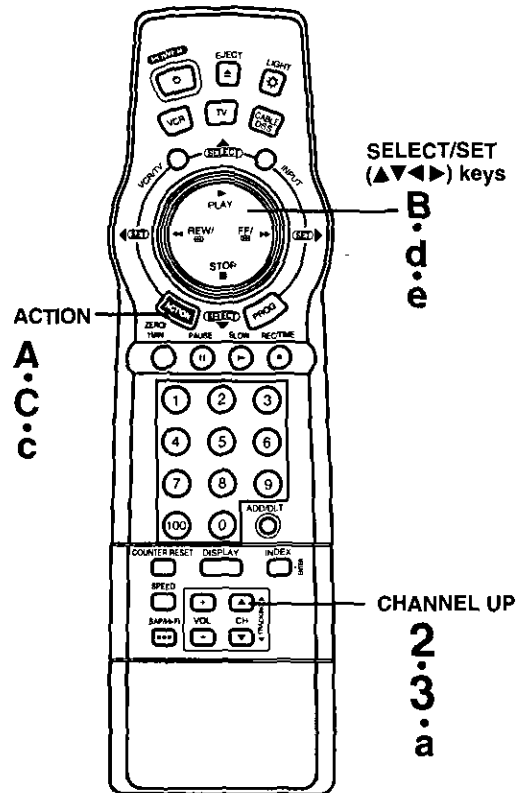

If the displayed time and DST are not correct...

If you happen to live close to two time zones, the D-VHS VCR may have recognized the PBS channel (setting channel) in the wrong time zone. Please do the following to correct the situation.

- Make a note of the SETTING:CH number shown on screen and press CH ▲ to exit.
- Delete the setting channel from the D-VHS VCR channel memory. (See the "To Add or Delete a Channel" section on page 33.)
- Press ACTION to display the menu.
- Press ▲▼ to select "SET CLOCK," and then press ▶ to display the "SET CLOCK" screen.
- Press ▲▼ and ▶ to select and set "AUTO CLOCK SET."
- Follow the One Time D-VHS VCR Setup instructions on pages 12 ~ 14.
 - If you use a cable box and have multiple PBS stations, tune the cable box to a different PBS station and try auto clock set using the menu.

Check list before you begin.

- All connections are made. (See pages 6-11.)
- TV and D-VHS VCR are plugged in.
- TV is turned on and set to the D-VHS VCR channel (CH 3 or 4).

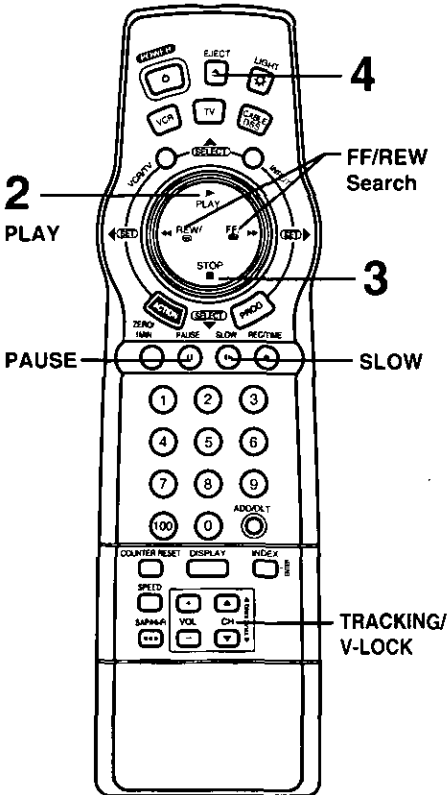
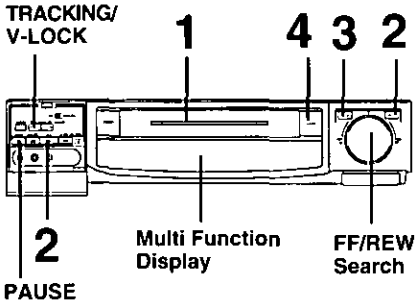

1 Insert a cassette.

- D-VHS VCR power comes on automatically.
- "VCR" lights in the Multi Function Display.

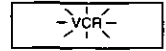

2 Press PLAY on the remote or D-VHS VCR to start playback.

- Playback begins automatically if cassette has no record tab.

3 Press STOP on the remote or D-VHS VCR to stop playback.

- To rewind the tape, press REW.

4 Press EJECT on the remote or D-VHS VCR to eject the cassette.

- You may eject a cassette with power on or off.

To Find a Particular Scene During Playback

Press REW or FF during playback to search for a scene.

- Search speed for SP mode tapes is 7 times and SLP mode tapes is 21 times the normal speed.
- Some noise bars will appear during search.

Special Effects During Playback

These features work best in SP or SLP mode. The sound will be muted.

Slow Motion Playback

Press SLOW to start slow motion playback during playback. Press PLAY or SLOW to release.

Still (Freeze) Frame Picture

Press PAUSE to freeze and release the picture. To reduce picture noise, first press SLOW. Then, use CH (TRACKING) ▲/▼ to clear up the picture. Now, press PAUSE.

Frame by Frame Advance

In Still mode, hold down SLOW to advance the still picture one frame at a time. Press PAUSE to release.

Features for a Quality Picture

Digital Auto Picture

This feature automatically controls the video output signal for less noise depending on the tape condition.

Digital Auto Tracking

This feature continuously analyzes the signal and adjusts for optimum picture quality.

Manual Tracking Control (to reduce picture noise)

Use during Playback and Slow Motion mode to reduce picture noise. Press CH (TRACKING) ▲/▼ during playback until the picture clears up. To return to Auto Tracking mode, press POWER off and then on again.

V-Lock Control (to reduce picture jitter)

In Still mode, CH (TRACKING) ▲/▼ operate as a V-Lock control. Press ▲/▼ until the picture is stabilized.

Caution:

Please inspect your cassette tapes and remove any loose or peeling labels to prevent them from becoming jammed in your unit.

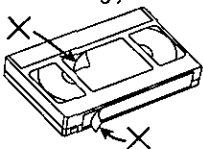

- After the D-VHS VCR is in Still or Slow mode for 1 minute, it will switch to the Stop mode automatically to protect the tape and the video head.
- Above "Special Effects During Playback" and "Features for a Quality Picture" are not available for D-VHS playback.

VHS Recording

***Important:** If the remote control POWER, ACTION, PROG, CH▲▼, INDEX or ADD/HLT button does not work when pressed, press the VCR button on the remote and try the button again.

Check list before you begin.

- All connections are made. (See pages 6~11.)
- D-VHS VCR is plugged in.
- TV is turned on and set to the D-VHS VCR channel (CH 3 or 4).

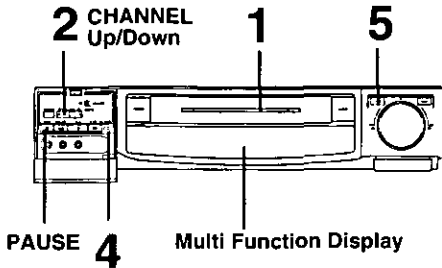

1 Insert a cassette with record tab.

- D-VHS VCR power comes on automatically.

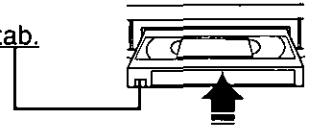

2 Press CH ▲▼* or NUMBERED keys to select a channel.

- Or, press CH ▲▼ on the D-VHS VCR.
- Holding down CH ▲▼ will increase the channel search speed.
- To record from an outside source, press CH ▲▼ or INPUT to select "LINE" (see page 17).

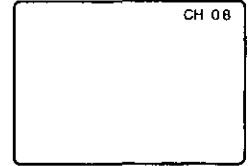

3 Press SPEED to change the recording speed.

- SP = Standard Play
- LP = Long Play
- SLP = Super Long Play (See page 34.)

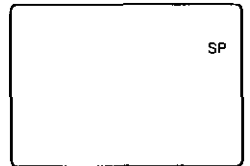

4 Press REC/TIME on the remote control or D-VHS VCR to start recording.

- To edit out unwanted portions, press PAUSE to pause the recording in progress. To release, press PAUSE again. (After the D-VHS VCR has been in Pause mode for 5 minutes, it will stop automatically to protect the tape and video head.)

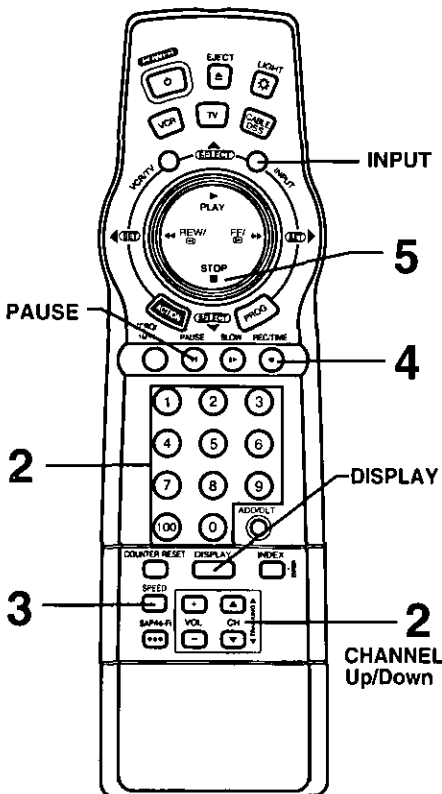

One Touch Timer Recording (OTR)

The D-VHS VCR starts recording and turns itself off at a preset time. In step 4, **press REC/TIME** repeatedly to set the length of the recording. Each push will change the stop time as shown.

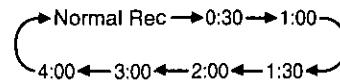

- "TIMER" lights and the stop time is displayed in the Multi Function Display.
- The remaining recording time can be displayed by pressing DISPLAY in OTR mode.

5 Press STOP to stop recording.

- Or, press STOP on the D-VHS VCR.

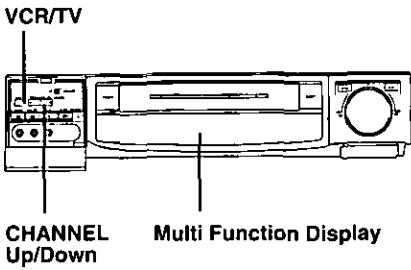

Selecting the Input Mode

Press INPUT.
The display will change in the order below.

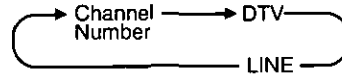

or

Press CH ▲/▼.
The display will change in the order below.

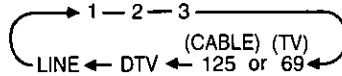

- DTV: For rear audio/video connection of NTSC signal or digital interface jack with IEEE1394 connection.
- When DTV is selected, "d" is displayed in the Multi Function Display.
- LINE: For front audio/video connection.
- When LINE is selected, "L" is displayed in the Multi Function Display.

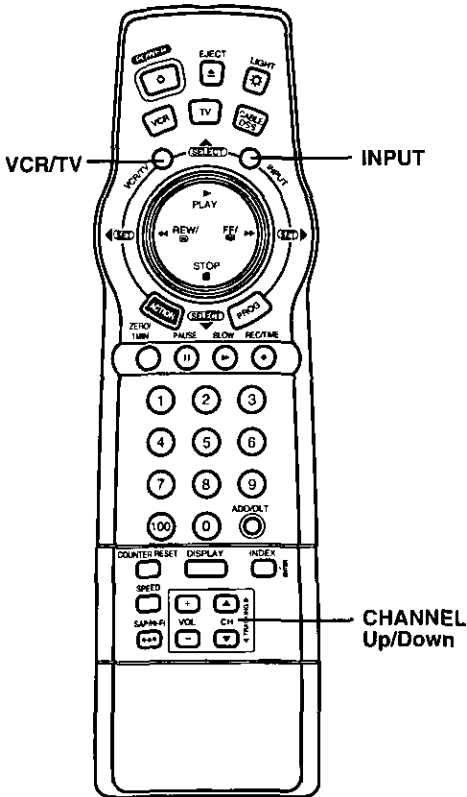

Record One Program While Watching Another

- 1 Press VCR/TV while recording is in progress to turn off the VCR indicator in the Multi Function Display.
- 2 Use the TV channel controls to select a program. The VCR will continue to record your program while you watch any channel you choose.
 - To switch back and forth between the recording and viewing channel, press VCR/TV.

Selecting Channels at the D-VHS VCR

- 1 Turn your TV and D-VHS VCR on.
 - VCR Indicator lights on the Multi Function Display. If indicator doesn't light, press VCR/TV to turn it on.
- 2 Use CH ▲/▼ on the remote control or D-VHS VCR to select channels.
 - To switch back to TV channel selection, press VCR/TV to turn VCR indicator off, or simply turn the D-VHS VCR power off.

D-VHS (Digital) Playback

Check list before you begin.

- All connections are made. (See pages 6-11.)
- D-VHS VCR is plugged in.
- Set Top Box and Digital TV are turned on.

1 Insert a pre-recorded D-VHS cassette.

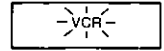

- D-VHS VCR power comes on automatically.
- "VCR" lights in the Multi Function Display.

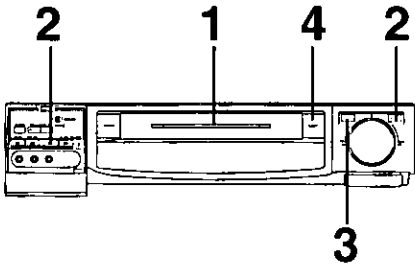

2 Press PLAY on the remote or D-VHS VCR to start playback.

- Playback begins automatically if cassette has no record tab.

3 Press STOP on the remote or D-VHS VCR to stop playback.

- To rewind the tape, press REW.
- To fast forward the tape, press FF.

4 Press EJECT on the remote or D-VHS VCR to eject the cassette.

- You may eject a cassette with power on or off.

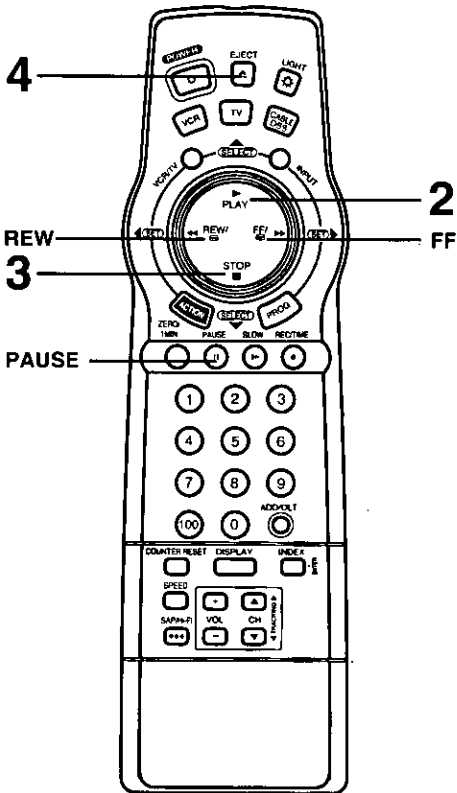

Additional D-VHS Playback Feature

Still (Freeze) Frame Picture

Press PAUSE to freeze and release the picture.

NOTES

- If "NOT PRESENT" is displayed on the screen, even though connections are made correctly, turn the Set Top Box power off and then on again.
- Digital programs recorded on other brand digital VCRs may not play back on this D-VHS VCR.
- This D-VHS VCR can play back tapes with copy protection. However, the TU-DST50 Set Top Box is not compatible with copyrighted programs. To watch copyrighted programs, a compatible Set Top Box is necessary. When copy protected program is detected during digital playback, "CP"(Copy Protection) is displayed in the Multi Function Display.
- When "CP" is displayed in the Multi Function Display and the Set Top Box is not compatible with the copyrighted program, the screen will turn solid black.
- When playing back tapes recorded with multi-programs, you can select the desired program for playback using the Set Top Box remote control.
- If the picture is not displayed during digital playback, press STOP and PLAY again.

D-VHS (Digital) Recording

NOTE: When using Panasonic Set Top Box TU-DST50 or TU-DST51, D-VHS switch should be set to HS mode. Maximum recording Time will be 2.5 hours (DF-300 Tape).

✓ Check list before you begin.

- All connections are made. (See pages 6~11.)
- D-VHS VCR is plugged in.
- Set Top Box is turned on.

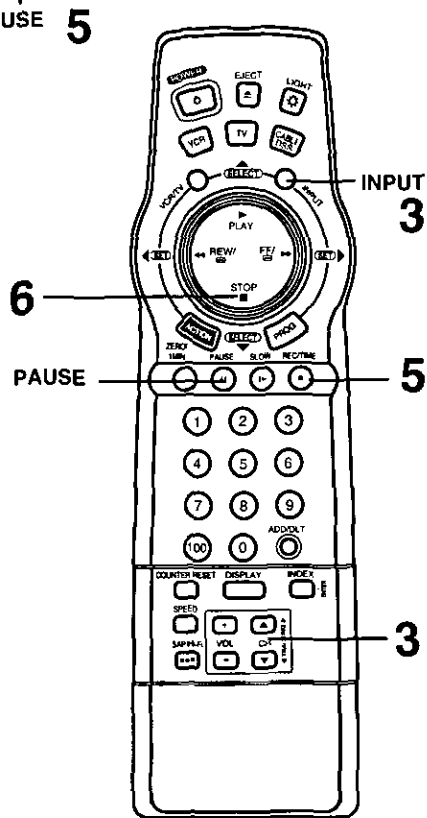
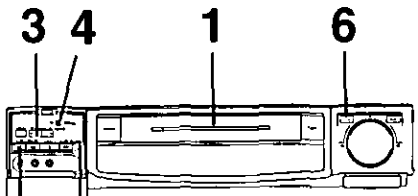

1 Insert a D-VHS cassette with record tab.

- D-VHS VCR power comes on automatically.

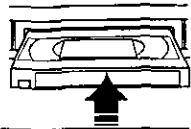

2 Select a recording channel with the Set Top Box.

- If necessary, refer to your Set Top Box manual.

3 Press CH ▲/▼ or INPUT to select "DTV" (see page 17).

4 Slide D-VHS Switch to HS or HS/STD.

- D-VHS indicator will light.

HS: Digital recording is performed. Tape speed is SP (Standard Play) mode and recording period is 2.5 hours when DF-300 tape is used.

HS/STD: HS or STD (Standard) recording is selected automatically.

ANALOG: Analog recording is performed. To change the recording speed, press SPEED (see page 34).

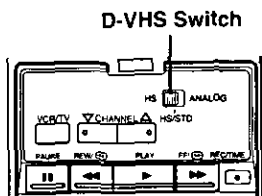

5 Press REC/TIME on the remote or D-VHS VCR to start recording.

- To edit out unwanted portions, press PAUSE to pause recording.

One Touch Timer Recording (OTR)

The D-VHS VCR starts recording and turns itself off at a preset time.

In step 5, press **REC/TIME** repeatedly to set the length of the recording. Each push will change the stop time.

- "TIMER" lights and the stop time is displayed in the Multi Function Display.

NOTE: If you start the recording with recording command feature of the Set Top Box, the One Touch Timer Recording is not available.

6 Press STOP on the remote or D-VHS VCR to stop recording.

NOTE: Programs which have copy protect data cannot be recorded and recording will be stopped. Then "THIS PROGRAM IS RECORD PROHIBITION" is displayed on the screen. When copy protected program is detected during digital recording, "CP" (Copy Protection) is displayed in the Multi Function Display.

- If "INPUT SIGNAL NOT FOUND" is displayed on the screen and/or "SnF" is displayed in the Multi Function Display during digital recording, make sure the IEEE1394 cable is properly connected and/or turn the Set Top Box power off and then on again.
- You can view only the channel being recorded during D-VHS recording.

NOTES

Caution: Unauthorized exchanging and/or copying of copyrighted recordings may be copyright infringement.

Timer Recording

***Important:** If the remote control POWER, ACTION, PROG, CH▲▼, INDEX or ADD/HLT button does not work when pressed, press the VCR button on the remote and try the button again.

You can set up the D-VHS VCR to record a one time, daily, or weekly program while you are away or otherwise occupied. Up to 8 programs can be stored in memory.

✓ Check list before you begin.

- All connections are made. (See pages 6-11.)
- TV and D-VHS VCR are plugged in and turned on.
- VCR/TV selector is set to "VCR."
- Clock is set to correct time.
- Record tab in place. (See page 34.)
- When Digital Timer Recording, use the D-VHS cassette tapes.

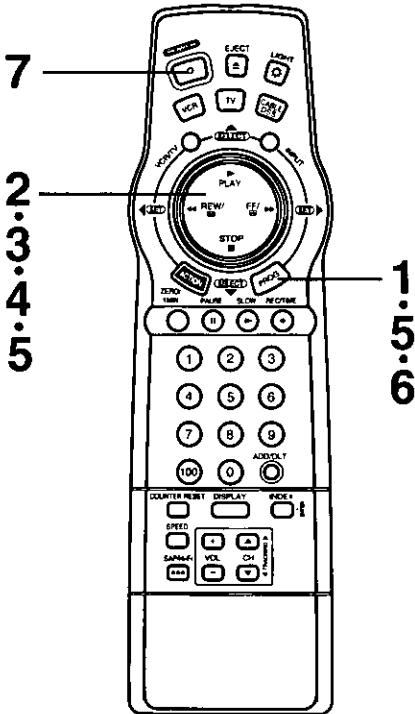
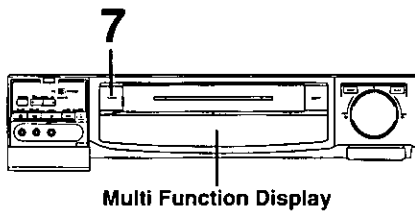

Important notes when using a DSS receiver

- When recording programs via a DSS receiver, the DSS receiver must be left on.
- When recording programs via an antenna or cable, the DSS receiver must be turned off.

1 Press PROG* to display the "SET PROGRAM" screen.

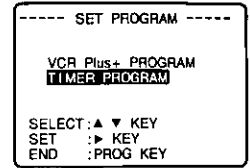

2 Press ▲▼ to select "TIMER PROGRAM," and then press ► to display the program screen.

- If a program is already in memory, press ▲▼ and ► to select an unused program number.

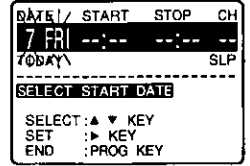

3 Press ▲▼ and ► to select and set one of the following:

- 1-31 = One time recording
- DAILY = Same time MON-FRI
- WEEKLY (SUN-SAT) = Same time once a week

Example

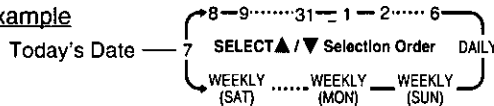

4 Press ▲▼ and ◀▶ to select and set each of the remaining items at right.

- If you want to record digital TV, channel selection should be "DTV."

- Remaining Items to be set:**
- START time
 - STOP time
 - CH(annel) number, DTV or LINE for outside source recording
 - Speed (SP, LP, SLP)

To Make Corrections

Repeatedly press ► to move the cursor to the right, or ◀ to move to the left to the incorrect entry and make the correction.

5 Press PROG to end the program.

- This screen appears for confirmation.

If you use a DSS receiver and enter a channel number of 100-125, the screen at right appears.

Press ▲▼ to select "DSS" or "CABLE," and then press ► to enter.

- The confirmation screen appears above right after this selection.

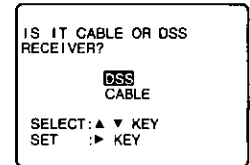
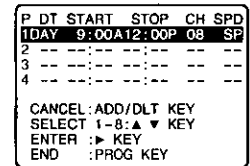

To Enter More Programs

Press ▲▼ and ► to select and set a blank program number, and then repeat steps 3 and 4.

6 Press PROG to exit this mode.

7 Press POWER off to set the timer.

- **When recording programs via a cable box, make sure the cable box is left ON and tuned to the desired channel.**



Multi Function Display

- **For DTV Timer Recording, make sure the set top box (TU-DST50) is left ON, and turned to the desired channel. On the VCR, D-VHS switch is set to HS or HS/STD and power is off.**



- Digital programs which have copy protect data cannot be recorded.
- A cassette with no record tab is ejected and "TIMER" flashes when the power is turned off to set the timer.
- If the start times of two programs overlap, the lower numbered program will have priority.
- If the start time for a timer recording comes up during a normal recording or One Touch Recording (pages 16, 17, 19), the timer recording will not be performed.
- If there is a power interruption of more than one minute, the recording will not be performed or continue.
- If a timer recording by the D-VHS VCR and by the Set Top Box overlap, only the earlier program will be performed.

Cancel a Timer Recording: (Recording is in progress)

Press POWER and then STOP within 10 seconds to cancel the timer recording.

- The TIMER indicator goes out in the Multi Function Display.

Replace Program Contents: (Recording is not in progress)

- 1 Press PROG to display the "SET PROGRAM" screen.
- 2 Press ▲▼ to select "TIMER PROGRAM," and then press ► to display all currently set programs.
- 3 Press ▲▼ and ► to select and set a program number.
(See page 20.)
- 4 Press ▲▼ and ◀▶ to select and set replacement timer information.
- 5 Press PROG twice to exit this mode.

```

----- SET PROGRAM -----
VCR Plus+ PROGRAM
TIMER PROGRAM

P DT START STOP CH SPD
1 8 10:00P 12:00A 125 SP
2 10 8:00P 9:00P 10 SP
4 SU 9:00P 10:00P L LP

SELECT 1-8: ▲ ▼ KEY
ENTER : ► KEY
END : PROG KEY
    
```

```

DATE/ START STOP CH
8 SAT 10:00P 12:00P 125
TODAY
SELECT START DATE
SELECT: ▲ ▼ KEY
SET : ◀ ▶ KEY
END : PROG KEY
    
```

Review or Clear Program Contents: (Recording is not in progress)

- 1 Press PROG to display the "SET PROGRAM" screen.
- 2 Press ▲▼ to select "TIMER PROGRAM," and then press ► to display all currently set programs.
- 3 Press ▲▼ to select a program number.
- 4 Press ADD/DLT if you want to clear the program.
- 5 Press PROG to exit this mode.

```

----- SET PROGRAM -----
VCR Plus+ PROGRAM
TIMER PROGRAM

P DT START STOP CH SPD
1 DAY 9:00A 12:00P 08 SP
2 8 10:00P 12:00A 125 SP
3 10 8:00P 9:00P 10 SP
4 SU 9:00P 10:00P L LP

CANCEL: ADD/DLT KEY
SELECT 1-8: ▲ ▼ KEY
ENTER : ► KEY
END : PROG KEY
    
```

```

P DT START STOP CH SPD
1 8 10:00P 12:00A 125 SP
2 10 8:00P 9:00P 10 SP
4 SU 9:00P 10:00P L LP

SELECT 1-8: ▲ ▼ KEY
ENTER : ► KEY
END : PROG KEY
    
```

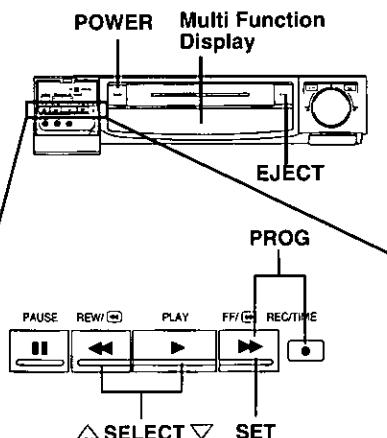
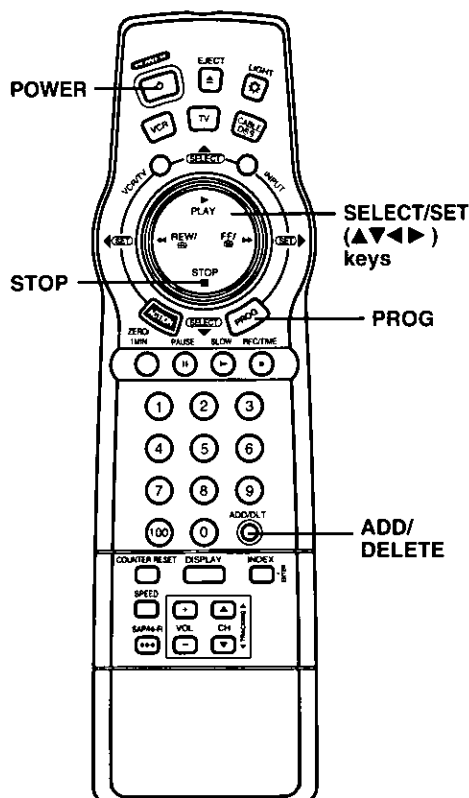
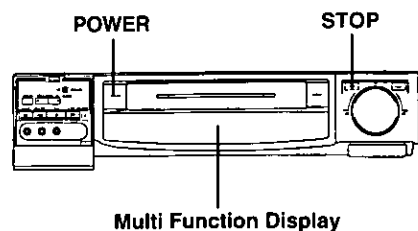

Timer Recording Using D-VHS VCR Buttons (Make sure a cassette tape is not inserted in the D-VHS VCR.)

- 1 Hold down REC/TIME and press FF to enter the Program mode.
- 2 Press REW or PLAY repeatedly or hold down to make selections.
- 3 Press FF to set the item and move on.
 - To make corrections, repeatedly press FF repeatedly to move to a particular item for setting or correction.
- 4 Press REC/TIME and FF together to display program contents after all items have been entered.
 - You cannot clear programs with the VCR buttons.
- 5 Hold down REC/TIME and press FF, (release FF first, and then release REC/TIME) to exit this mode.
- 6 Insert a cassette with record tab and press POWER off to set the timer.

VCR Plus+ System Setup

***Important:** If the remote control POWER, ACTION, PROG, CH▲▼, INDEX or ADD/HLT button does not work when pressed, press the VCR button on the remote and try the button again.

In order for the D-VHS VCR to read the VCR Plus+ code, some set up is required. A Guide (VCR Plus+) channel number is assigned to each local broadcast and cable station. Because this number sometimes differs from the channel your TV receives the station on, it is necessary to program the D-VHS VCR with local channel information.

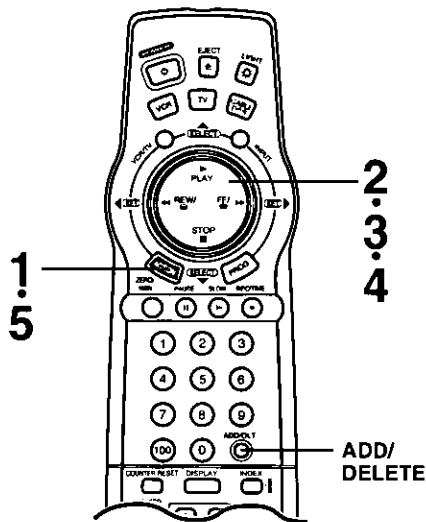

Channel Setup Preparations

NOTE: Complete the steps on this page if your cable box can be controlled with the D-VHS VCR, or your D-VHS VCR hook-up resembles "B" on page 10.

Prepare a list like the example below. This list will help you smoothly enter the information needed in step "4" at right.

You will need the following to complete the list:

- A line up of normal and/or cable stations you receive along with the channel numbers your TV receives them on. A cable channel line-up chart is supplied by your cable company.
- A list of Guide (VCR Plus+) channel numbers assigned to the stations you receive. This list is available in *TV Guide* and the TV listings found in selected newspapers.

- 1 Make a chart with 3 columns like the example below. In the left column, fill in the name or call letters of the stations you receive.
- 2 In the middle column, fill in each station's assigned Guide (VCR Plus+) number found in *TV Guide*, newspapers, etc.
- 3 In the right column, fill in the channel number that your TV receives the station on from your channel line-up.

EXAMPLE ONLY

Broadcast or Cable Station Name	Assigned Guide (VCR Plus+) channel no.	Channel no. your TV receives the station on
HBO	33	15
Nickelodeon	38	20
CBS	04	04
FOX	11	

VCR Plus+ Channel Setup

Complete this page only if Type B connection method (pg. 10) is used.

- Before you begin, complete the Channel Setup Preparations below left.

Important Note:

If your D-VHS VCR connection type changes from type A to B, perform "To Setup the D-VHS VCR in Case a Cable Box or DSS Receiver was Installed or Replaced" section on page 33 before proceeding with these steps.

- 1 Press **ACTION*** to display the menu.

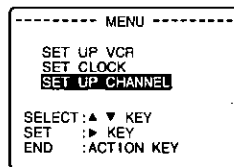

- 2 Press **▲▼** to select "SET UP CHANNEL," and then press **▶** to display the "SET UP CHANNEL" screen.

- 3 Press **▲▼** to select "VCR Plus+ CH SET UP," and then press **▶** to display the "VCR Plus+ CH SET UP" screen.

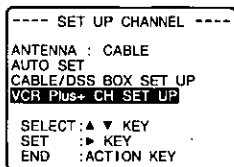

IMPORTANT NOTE:

For step "4," use the list you prepared. You may leave lines blank if you don't receive that station, or if the GUIDE CH number and the CABLE (or TV) CH numbers are the same.

- 4 Press **▶** to move the shaded area to the right side.

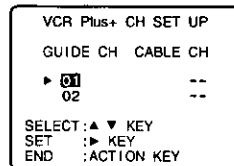

Then, press **▲▼** to change CABLE or TV CH number.

Next, press **◀** to set the number.

Now, press **▲▼** to continue.

Repeat this operation until the list is complete.

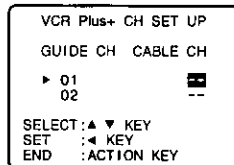

To Enter More Programs

Press **▲▼** and **▶** to select the incorrect CABLE or TV CH number. Then, press **▲▼** to change, or ADD/HLT to delete the channel.

- 5 Press **ACTION** three times to exit the VCR Plus+ CH SET UP mode.



- Make each entry within 5 minutes or the D-VHS VCR will leave this mode.
- Once local channels have been programmed, they will stay in memory, even in the case of a power failure.

VCR Plus+C³ and PlusCode are registered trademarks of Gemstar Development Corporation. The VCR Plus+ system is manufactured under license from Gemstar Development Corporation.

VCR Plus+ System Programming

- Check list before you begin.
- The clock is set.
- VCR Plus+ Setup is complete (see page 22).

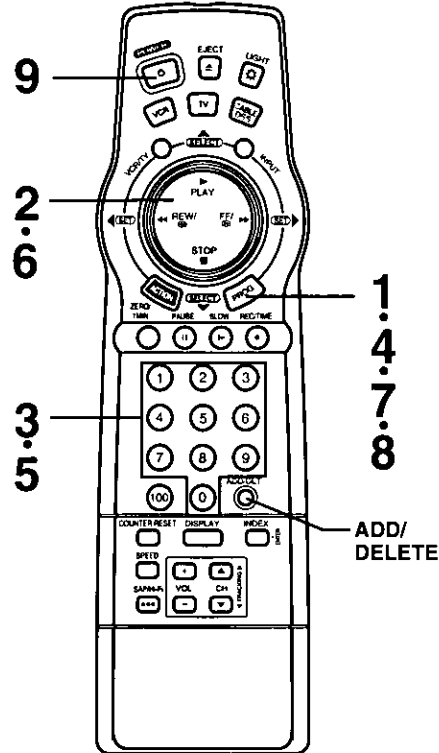
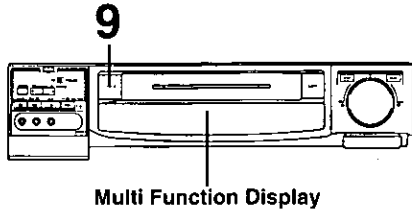

1 Press **PROG** to display the "SET PROGRAM" screen.

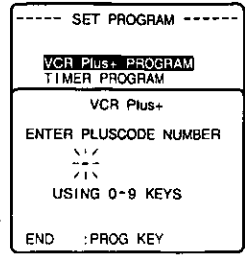

2 Press **▲▼** to select "VCR Plus+ PROGRAM," and then press **▶** to display the "VCR Plus+" screen.

3 Press the **NUMBERED** keys to enter the PlusCode number.

- Refer to your local TV listings.

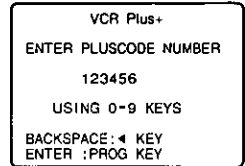

To Make Corrections

Press **◀** repeatedly to delete the PlusCode number. Then, enter the correct number.

4 Press **PROG** to lock in your program.

5 Press the **1, 2 or 3** key to select the program type.

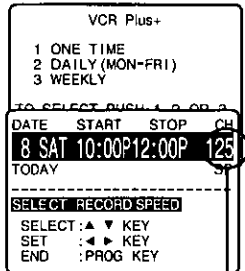

6 Press **▲▼** and **▶** to select and set each of the remaining items as follows.

Remaining Items

- Speed (SP, LP, SLP)

To Make Corrections

Repeatedly press **▶** to move the cursor to the right, or **◀** to move to the left to the incorrect entry and make the correction.

- If you use connection type "A" on page 10, the channel shown in this on-screen display will always be the cable box output channel number.

7 Press **PROG** if contents are acceptable.

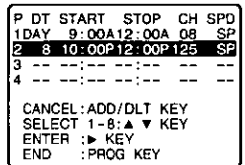

To cancel program contents:
Press **ADD/DLT**.

8 Press **PROG** to complete the program.

- If you're using a Cable Box, make sure that it is tuned to the desired channel and the power is left on for timer recording.

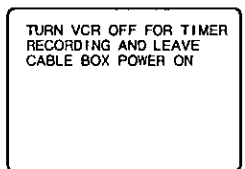

- This display may differ depending on your cable box hook-up.

9 Press **POWER** off to set the timer.



Multi Function Display

Use normal Timer Recording steps if:

- the PlusCode for a program is not listed.
- you anticipate the program, such as a sporting event, to run over the scheduled stop time.

See page 21 to:

- cancel a timer recording in progress.
- replace program contents.
- review or clear program contents once set.

Important notes when using a DSS receiver

- When recording programs via a DSS receiver, the DSS receiver must be left on.
- When recording programs via an antenna or cable, the DSS receiver must be turned off.

NOTES

- Digital programs cannot be programmed with VCR Plus+ because PlusCodes are not available.
- You can obtain unlisted PlusCode numbers by calling 1 - 900 - 454 - 7587. Call costs approximately \$.95 per minute.
- VCR PlusCodes can not be used to program the D-VHS VCR to record DSS channels.
- Avoid overlapping program times.
- An on-screen display will indicate if an invalid PlusCode number has been entered or when all timer programs are full.

Advanced Operation

Multi-Brand Control Feature

The Remote Control may be set up to control some of the functions on your TV or Cable Box.

TV Brand Code Numbers

Panasonic	01, 02	Sony	08
Quasar	01, 02	Toshiba	09
RCA	03	Sanyo	10
GE	03	Fisher	10
Zenith	04	JVC	11
Magnavox	05	Hitachi	12
Sylvania	05	Mitsubishi	07, 13
Sharp	06, 07	Samsung	14
		Gold Star	15, 16, 17

DSS Brand Code Numbers

Toshiba	103
Hitachi/ Hughes	104
Magnavox/ Uniden 1	105
Magnavox/ Uniden 2	106
Sony	107
RCA	108
Panasonic	109

Cable Box Brand Code Numbers

Archer	01, 29, 44, 88, 91
Cableview	04, 30, 42, 44, 52, 63, 85, 88
Citizen	04, 30, 42, 44, 52, 63, 85, 88
Curtis	08, 09, 56, 61, 87, 90
Diamond	01, 29, 44, 88, 91
Drake	37, 67, 71
Eagle	13, 20, 22, 26, 40, 58, 62, 98
Eastern	28
GC Brand	04, 30, 42, 44, 52, 63, 85, 88
Gemini	04, 85
General Electric	57
General Instruments	01, 02, 03, 04, 34, 55, 83, 85, 91, 93, 95
Hamlin	14, 15, 28, 41, 97, 100, 102
Hitachi	31, 79
Jerrold	01, 02, 03, 04, 34, 55, 83, 85, 91, 93, 95
Macom	31, 79
Magnavox	25, 26
Matsushita	16, 17, 101
Movietime	29, 32, 38, 39, 40, 42, 44, 88
NSC	32, 38, 40
Oak	10, 11, 46, 99
Panasonic	16, 17, 101
Philips	13, 20, 23, 24, 96
Pioneer	05, 06, 78
Pulsar	04, 30, 42, 44, 52, 63, 85, 88
Radio Shack	44
RCA	16, 17, 101
Realistic	44, 51, 88
Regal	14, 41
Regency	28
Rembran	29, 32, 39, 42, 44, 88
Salora	68, 72
Samsung	32, 40, 42, 78, 94
Scientific Atlanta	08, 09, 56, 61, 87, 90
Sheritech	27
SL Marx	32, 40, 42, 78, 94
Spucer	16, 17, 101
Stargate	04, 30, 32, 40, 42, 44, 52, 63, 78, 85, 88, 94
Sylvania	19
Teknika	74
Telecaption	77, 92
Televue	32, 40, 42, 78, 94
Texscan	18, 19
Tocom	01, 33, 34, 42, 48, 49, 91
Toshiba	36
Uniden Satellite	65, 69
Unika	01, 29, 44, 88, 91
Universal	42, 43, 44, 52, 63, 88
Viewstar	13, 20, 22, 26, 40, 58, 62, 98
Videoway	07, 23, 50
Vid Tech	64
Vidter	64
Zenith	07, 23, 50

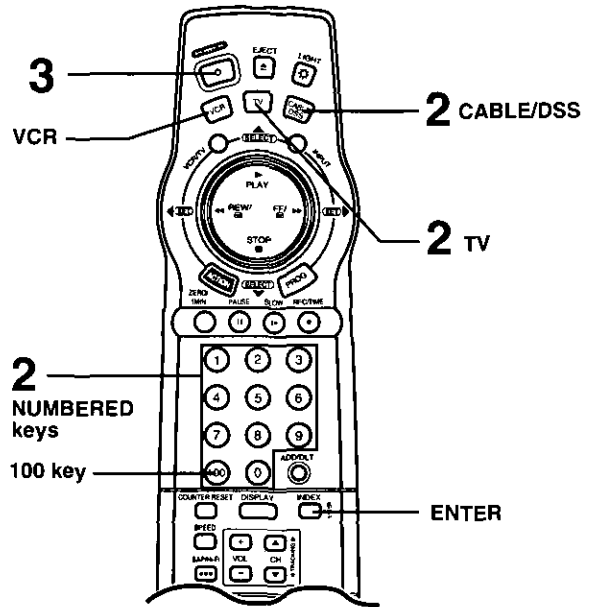

Multi-Brand Control Setup

- 1** Find your TV or Cable Box or DSS Box Brand Code Number from one of the charts on this page.
- 2** Hold down TV or CABLE/DSS. Use the NUMBERED keys to enter your TV or Cable Box Brand code number.
 - For code numbers 100 or greater, first press the 100 key. Then, enter the remaining digit. E.g. for 102, press 100, then press 2.
- 3** To confirm that the correct code was entered, press POWER to turn your TV or Cable Box or DSS Box On/Off.
- 4** Try each of the functions listed on page 25.
 - Due to changes in infra-red commands used by some manufacturers, more than one code may be listed for some TV or Cable Box brands. If your TV or Cable Box does not respond to the first code, please try entering the next code.



- Please repeat the TV/Cable Box Set Up procedure when you replace the remote's batteries.
- The remote control is designed to control the brands listed. However, it will not operate all TVs, Cable Boxes or DSS Boxes made by these manufacturers. If you get no results, your particular product brand cannot be controlled by this remote control.

Using the Multi-Brand Control

Once the remote control has been properly set up, you can select VCR, TV, or CABLE/DSS mode depending on which functions you wish to control.

Press VCR or TV or CABLE/DSS on the remote control to select the desired mode.
(See below for the controllable functions of each mode.)

NOTE:

In TV or CABLE/DSS mode, it may be necessary to press ENTER after pressing NUMBERED keys for channel selection.

VCR Mode

In VCR mode, the following buttons are available.

VCR

All function buttons.

TV

VOL UP/DOWN

TV Mode

In TV mode, the following buttons are available.

TV

POWER, INPUT, NUMBERED keys, ENTER, CH UP/DOWN, VOL UP/DOWN

VCR

EJECT, LIGHT, VCR/TV, PLAY, STOP, FF, REW, PAUSE, ZERO/ 1 MIN, SLOW, REC/TIME, SAP/Hi-Fi, SPEED, COUNTER RESET, DISPLAY

CABLE/DSS Mode

In CABLE/DSS mode, the following buttons are available.

CABLE/DSS

POWER, NUMBERED keys, ENTER, CH UP/DOWN

TV

VOL UP/DOWN

VCR

EJECT, LIGHT, VCR/TV, PLAY, STOP, FF, REW, PAUSE, ZERO/ 1MIN, SLOW, REC/TIME, SAP/Hi-Fi, SPEED, COUNTER RESET, DISPLAY

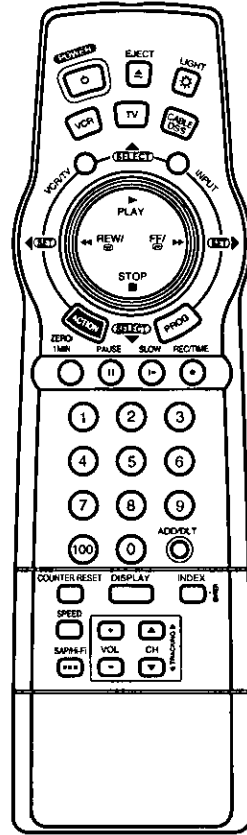
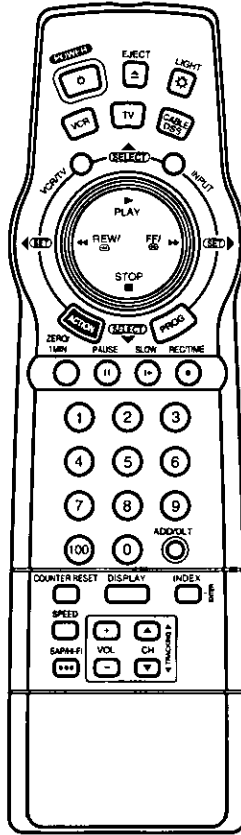
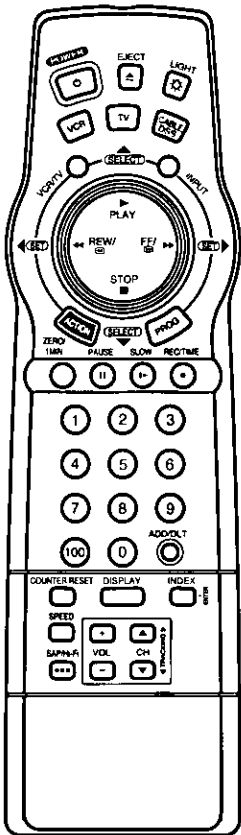

Advanced Operation



- It is not available to operate the set top box by using this remote control.
- Some TV, Cable Box and DSS Box brands require you to turn on the power manually.
- Not all functions listed may be controlled by this remote control.

MTS Broadcast/ VHS Hi-Fi Stereo System



Check list before you begin.

- The D-VHS VCR is connected to a stereo or Digital TV, or a mono TV and an external stereo amp or receiver with speakers.
- The D-VHS VCR and other components are plugged in and turned on.

Connections to Make

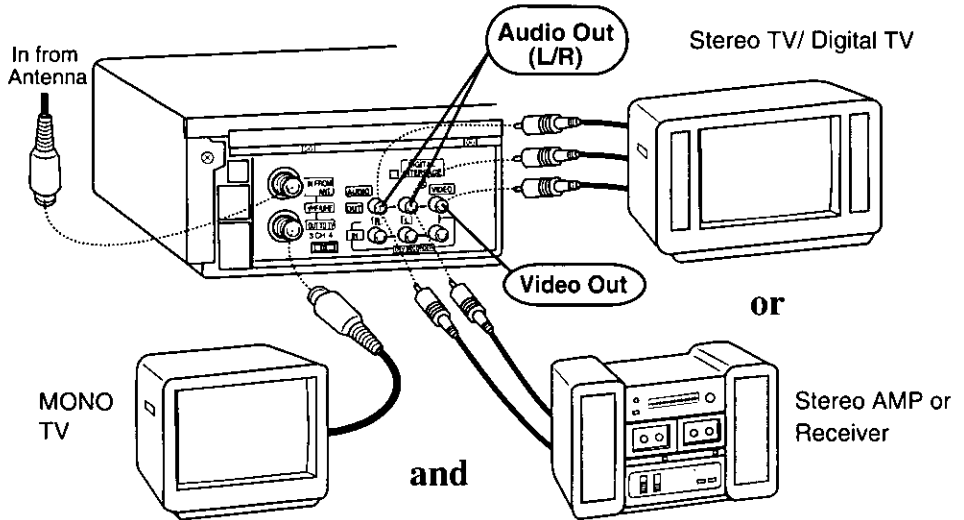

To monitor recording in progress in stereo, connect D-VHS VCR to stereo TV or mono TV and stereo amp with speakers.

Receivable Broadcast Types

The following are possible audio broadcast types and on-screen displays. The signal(s) not being received is enclosed in parenthesis. The currently selected audio mode is indicated with an arrow.

Press **DISPLAY** to display the broadcast signal currently being received.

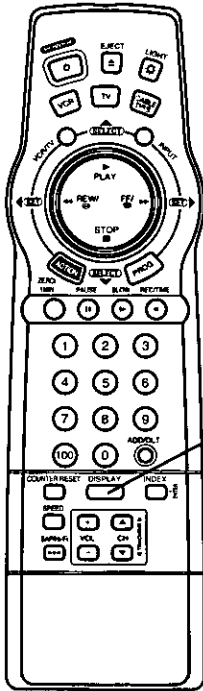

DISPLAY

MTS Stereo and SAP broadcast

Multi-channel Television Sound Stereo (main language) and Secondary Audio Program (sub language) broadcasts are being received simultaneously. Select STEREO or SAP audio mode.

STOP	12:00AM	CH08
		0:00:00
STEREO ◀		SLP
SAP		
MONO		

MTS Stereo broadcast

Multi-channel Television Sound Stereo broadcast. Select STEREO audio mode.

- If a stereo broadcast is weak and the display flickers, you may want to select the MONO audio mode for better results.

STOP	12:00AM	CH08
		0:00:00
STEREO ◀		SLP
(SAP)		
MONO		

SAP broadcast

Secondary Audio Program (sub language) broadcast. Select SAP audio mode for the sub language.

STOP	12:00AM	CH08
		0:00:00
(STEREO)		SLP
SAP ◀		
MONO		

MONO broadcast

Normal monaural sound broadcast.

STOP	12:00AM	CH08
		0:00:00
(STEREO)		SLP
(SAP)		
MONO ◀		

Equipped with **dbx**® -TV Noise Reduction for true MTS reproduction. **dbx**® -TV Noise Reduction is required for good stereo separation and audio fidelity. **dbx**® is a registered trademark, and is licensed by **dbx**® Technology Licensing.

With the proper audio mode setting, your D-VHS VCR can:

- 1) record and playback an MTS stereo broadcast (main language) in stereo Hi-Fi.
 - 2) record and playback a monaural broadcast (main language) or Secondary Audio Program (sub language) on the Hi-Fi tracks for better quality monaural sound.
 - 3) playback non Hi-Fi tapes in monaural.
- When recording, the selected broadcast sound is always recorded on the left and right Hi-Fi tracks as well as the normal monaural track. This means your tapes can be played back on Hi-Fi as well as non-Hi-Fi VCRs.

Audio Mode for Recording

1 Press SAP/Hi-Fi repeatedly (each press within 5 seconds) to select the desired audio mode (STEREO, SAP, or MONO).

- Please refer to the "Receivable Broadcast Types" section on page 26.

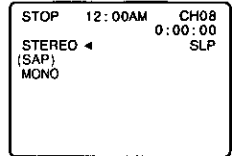

- The arrow indicates your selection.

2 Do a recording.

See the "VHS Recording" section on page 16.

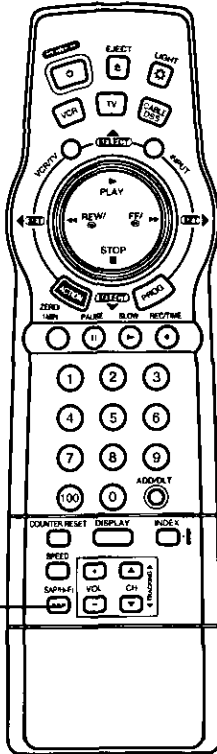

Audio Mode for Playback

A Playback the tape.

See the "VHS Playback" section on page 15.

B Press SAP/Hi-Fi repeatedly (each press within 5 seconds) to select the desired audio mode (HIFI or NORMAL).

- Select "HIFI" to listen to your stereo recordings with stereo sound, or "NORMAL" for monaural sound.

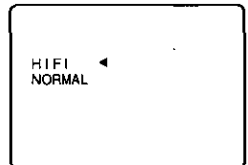

- The arrow indicates your selection.



- When purchasing or renting prerecorded tapes, remember that only those recorded in Hi-Fi stereo will play back with true stereo sound. Standard stereo tapes will play back with monaural sound.
- In order to listen to Hi-Fi stereo playback, the D-VHS VCR AUDIO (L/R) jacks must be connected to a stereo TV or an external stereo amp and speakers. (See page 26.)
- When adjusting the tracking during playback, the Hi-Fi audio sound may revert to normal audio sound. This is normal.
- There may be a difference in audio level between Hi-Fi and normal audio playback.

Tape Operation

***Important:** If the remote control POWER, ACTION, PROG, CH▲/▼, INDEX or ADD/HLT button does not work when pressed, press the VCR button on the remote and try the button again.

VHS Index Search System

Each time you start a recording, an invisible index mark is placed on the tape. You can then use these index marks to access or scan your recordings.

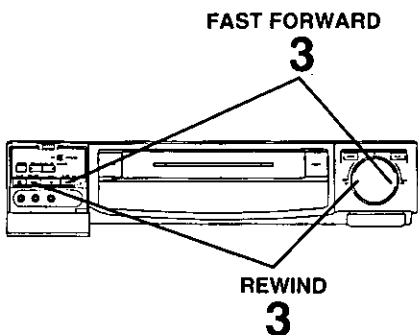

Direct Access

This feature allows you to go directly to the recording you want from anywhere on the tape by entering the appropriate index number.

1 Press **INDEX*** in Playback or Stop mode.

2 Press a **NUMBERED** key to select the desired recording.

- To calculate the number, see below.

3 Press **REW** or **FF** to start a reverse or forward search.

- When the designated location is reached, the D-VHS VCR goes into Playback mode.

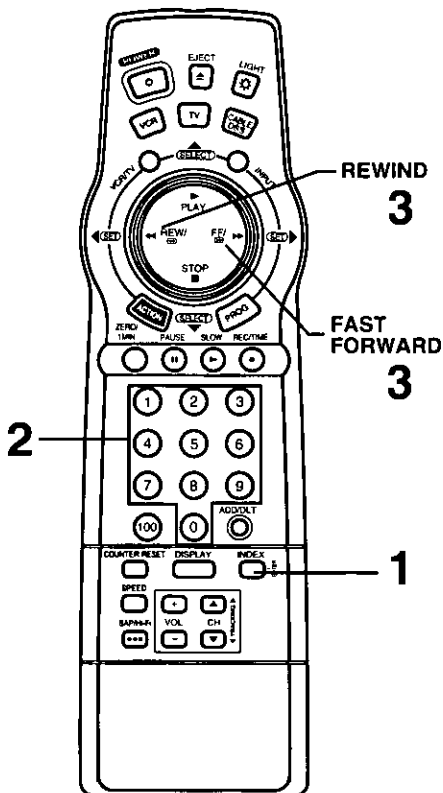
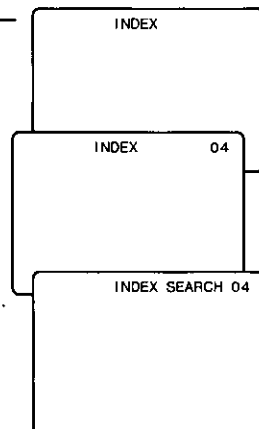

To calculate the Index Number

Count forward or backward each recording starting point, including the recording you want to see, from wherever you are on the tape.

Example 1:

If you are watching recording 4 and you want to watch recording 2, count the start points to number 2. The total is 3. Enter 3 in step "2" and press REW.

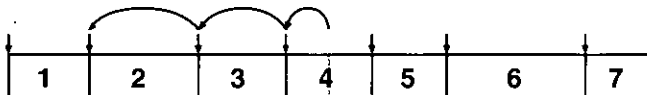

Example 2:

If you are watching recording 2 and you want to watch recording 6, count the start points to number 6. The total is 4. Enter 4 in step "2" and press FF.

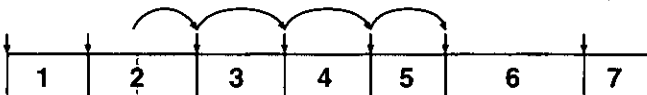

NOTE: ↓ indicates start points of each recording.



- Make each entry within 10 seconds, or the Index Search mode will be canceled.
- Index marks will be placed for Timer recordings as well.
- If any of the VHS Index Search System are initiated extremely close to an index mark, the index mark may not be counted in the search.
- In digital playback mode, no indications on the On-Screen-Display while searching.

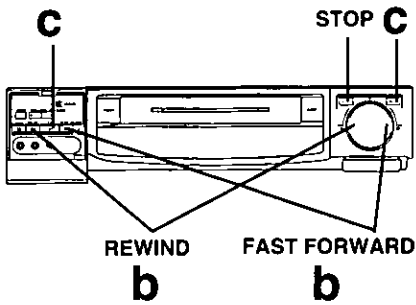

Index Scan

This feature allows you to scan (forward or reverse) each recording for 10 seconds in Playback mode.

a Press **INDEX** in Playback or Stop mode.

b Press **REW** or **FF** to begin the scan.

- As each index mark is reached, a short playback will be performed after which FF or REW resumes.

c Press **PLAY** to cancel the scan and begin playback.

- You may also press **STOP** to stop the tape.

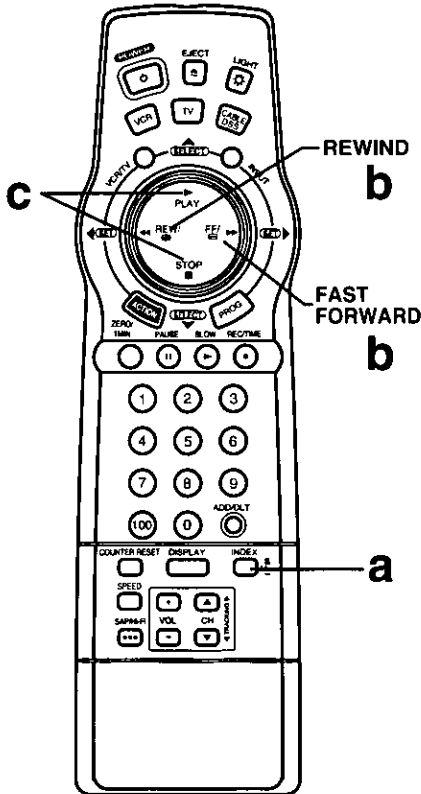
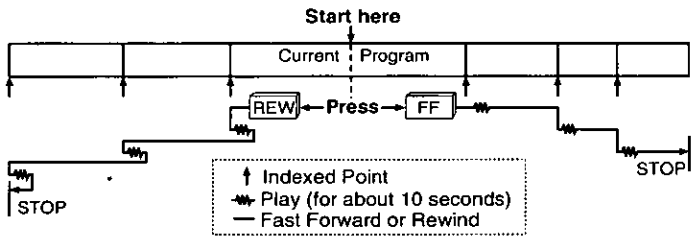
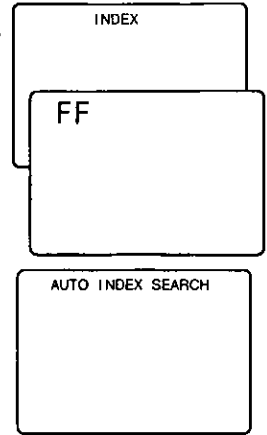

Shuttle Variable Speed Search

The SHUTTLE Ring allows you to smoothly control the tape speed during special effects playback in both forward or reverse.

1 Turn **SHUTTLE Ring** on the VCR while in Play or Still mode to place the forward or reverse search.

- The more you turn the Ring, the faster the search speed will be.

2 Press a **function button** such as: **PLAY**, **STOP**, etc. on the VCR or remote control to release the Shuttle mode.

- The VCR performs the function of the button pressed.



- In digital playback mode, SHUTTLE Operation is not available.
- When the SHUTTLE Ring is turned more than half in Stop mode, normal Fast Forward or Rewind will begin.
- Some noise bars are normal during Shuttle operation.
- After 1 minute in Still or Slow, the VCR will go into Stop mode.
- When the SHUTTLE Ring is released, the VCR goes into Still mode.

Tape Operation (continued)

***Important:** If the remote control POWER, ACTION, PROG, CH▲/▼, INDEX or ADD/HLT button does not work when pressed, press the VCR button on the remote and try the button again.

Your D-VHS VCR is equipped with several time saving features as well as convenient automatic functions making tape operation easier than ever.

- Some screens shown here may not be displayed during digital playback.

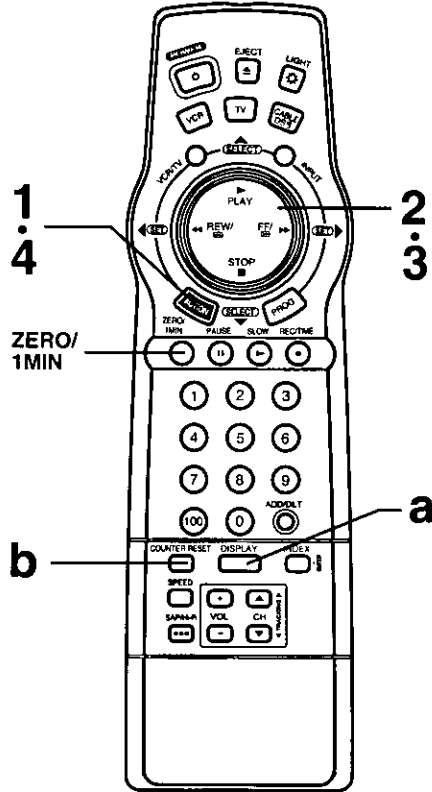

Repeat Play

The D-VHS VCR will play your recording over and over.

1 Press **ACTION** to display the menu.

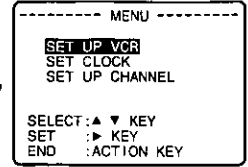

2 Press ▲▼ to select "SET UP VCR," and then press ► to display the "SET UP VCR" screen.

3 Press ▲▼ to select "REPEAT PLAY," and then press ► to select "ON" or "OFF."

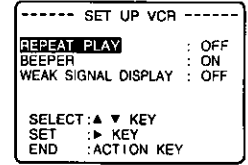

- When "ON" is selected, the D-VHS VCR plays the tape to its end or until a blank portion of over 30 seconds is detected (erased portions are not considered blank). The tape is then rewound and played again and again until Repeat Play is turned off.

4 Press **ACTION** twice to return to the normal screen.

One Minute Skip

The D-VHS VCR rapidly skips over one minute of tape.

Press **ZERO/ 1MIN** in Play mode.

- The D-VHS VCR will go into FF search mode and skip over 60 seconds of recorded time. Normal playback will then resume.

Auto Operation Functions

Auto Playback

When a tape is inserted, the power turns on (Auto). If the record tab* is removed, playback begins (Auto).

Auto Rewind

When a tape reaches its end during playback, fast forward or manual record, the D-VHS VCR will rewind and go into Stop mode.

Playback Auto Eject (Repeat Play is "OFF.")

When a tape without a record tab* is played to its end, the D-VHS VCR will rewind and then eject the tape.

Memory Rewind Off

When the POWER button is pressed during rewind, the D-VHS VCR will turn off after rewind is complete.

* For record tab information, see page 34.

Zero Search

To quickly return to a specific tape location.

a Press **DISPLAY** to display the Time Counter overlay during playback.

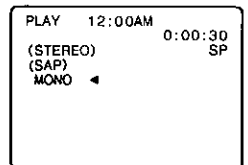

b Press **COUNTER RESET** to reset the Time Counter to "0:00:00" at the desired position.

c Continue playback, rewind, or fast forward.

d Press **ZERO/ 1MIN** in Stop mode when you want to return to "0:00:00."

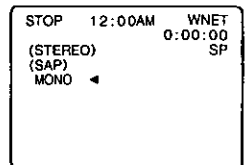

- The D-VHS VCR will go into FF or REW mode and stop at the last point the Time Counter was set to 0:00:00.

Copying Your Tapes (Dubbing)

Connections you'll need to make. (Choose front or rear connection.)

- When dubbing digital programs, connect DIGITAL INTERFACE jacks on the both D-VHS VCRs with IEEE1394 cable (supplied.)

TV for Monitoring

Recording (Editing) D-VHS VCR

Playing (Source) D-VHS VCR

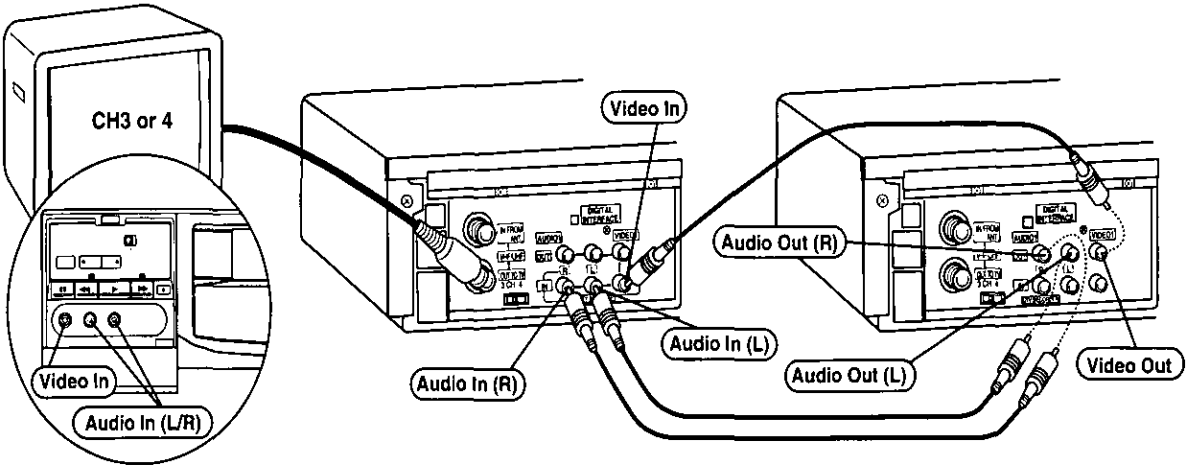

This connection for VHS cassette use is shown here.

- 1 Insert a pre-recorded tape into the Playing (Source) D-VHS VCR.



- 2 Insert a blank tape with record tab into the Recording (Editing) D-VHS VCR.

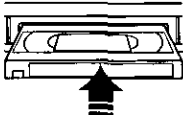

- When dubbing digital programs, use the D-VHS cassette tapes.

- 3 Select "DTV" or "LINE" Input mode on the Recording (Editing) D-VHS VCR. (See "Selecting the Input Mode" on page 17.)

- When dubbing digital programs, select "DTV" Input mode and slide D-VHS switch to HS or HS/STD.

- 4 Press **PLAY** on the Playing D-VHS VCR. Press **PAUSE** at the desired starting point.

- 5 Press **REC** on the Recording D-VHS VCR, and then press **PAUSE** immediately thereafter.

- 6 Press **PAUSE** on both D-VHS VCRs at the same time, to begin copying.

To Edit Out Unwanted Parts

Press **PAUSE** on the recording D-VHS VCR while copying is in progress. Press **PAUSE** again to resume copying.

- 7 Press **STOP** on both D-VHS VCRs to stop copying.

To Monitor Dubbing on Your TV

- 1 Turn your TV on and tune to the Recording D-VHS VCR channel (CH3 or CH4).
- 2 Set the VCR/TV Selector on the Recording D-VHS VCR to "VCR."

Caution:

Unauthorized exchanging and/or copying of copyrighted recordings may be copyright infringement.



- Digital programs recorded on this D-VHS VCR may not play back on other digital VCR brands.
- Digital programs recorded on other brand digital VCRs may not play back on this D-VHS VCR.
- Digital programs which have copy protect data cannot be recorded and recording will be stopped. Then "THIS PROGRAM IS RECORD PROHIBITION" is displayed on the screen. When copy protected program is detected during digital recording, "CP"(Copy Protection) is displayed in the Multi Function Display.

Special VCR Features

✓ Check list before you begin.

- All connections are made. (See pages 6-11.)
- D-VHS VCR is plugged in.
- TV is turned on and set to the D-VHS VCR channel (CH 3 or 4).

• Some screens shown here may not be displayed during digital playback.

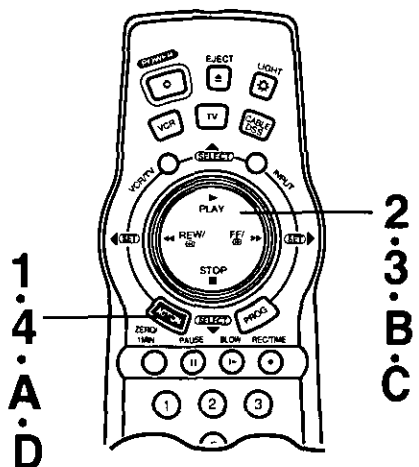
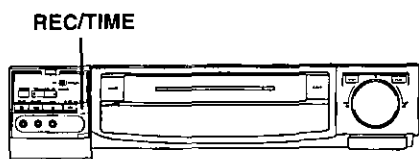

WEAK SIGNAL DISPLAY Feature

You may choose whether or not you want the VCR to display a solid blue screen when the broadcast signal is very weak or nonexistent.

1 Press **ACTION*** to display the menu.

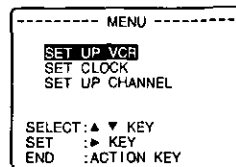

2 Press **▲▼** to select "SET UP VCR," and then press **►** to display the "SET UP VCR" screen.

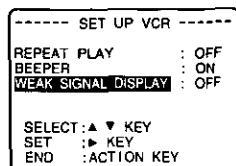

3 Press **▲▼** to select "WEAK SIGNAL DISPLAY," and then press **►** to select "ON" or "OFF."

- When "OFF" is selected, a solid blue screen appears whenever the signal is weak or nonexistent. When "ON" is selected, the picture is displayed regardless of the signal condition.
- The picture can not always be seen clearly when "ON" is selected.

4 Press **ACTION** twice to exit.



- When the VCR is connected to a Combination VCR which has a Blue Back feature, even if the VCR Blue Back is set to "ON" on the VCR, the screen will go to blue back.

VCR Lock Feature

When activated, this feature prohibits all operations except for timer recording and tape eject. This feature may be used to keep young children from operating the D-VHS VCR.

Hold down REC/TIME on the D-VHS VCR without a cassette inserted for **7 seconds** during Power On mode.

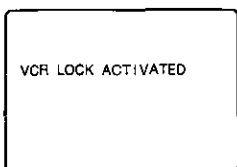

- "NO CASSETTE PLEASE INSERT A CASSETTE" is displayed when REC/TIME is pressed. Please disregard this warning and continue to hold down REC/TIME for 7 seconds.
- If an invalid key is pressed when this feature is activated, "HOLD" is displayed in the Multi Function Display for 5 seconds.
- DTV Timer Recording by the Set Top Box will not be performed when D-VHS VCR is in VCR Lock mode.

To Cancel the VCR Lock feature, Repeat above with or without a cassette inserted.

- VCR Lock mode is cancelled automatically after about 24 hours as long as the clock is set.
- In digital playback mode, no indications appear on-screen.

Warning Beeper Feature

When you select BEEPER ON, a short warning will sound each time an invalid entry or incomplete operation is made.

A Press **ACTION** to display the menu.

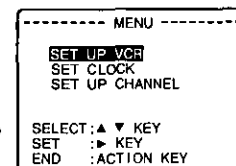

B Press **▲▼** to select "SET UP VCR," and then press **►** to display the "SET UP VCR" screen.

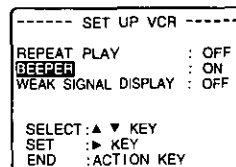

C Press **▲▼** to select "BEEPER," and then press **►** to select "ON" or "OFF."

D Press **ACTION** twice to exit this screen.

Reset Channel, Clock

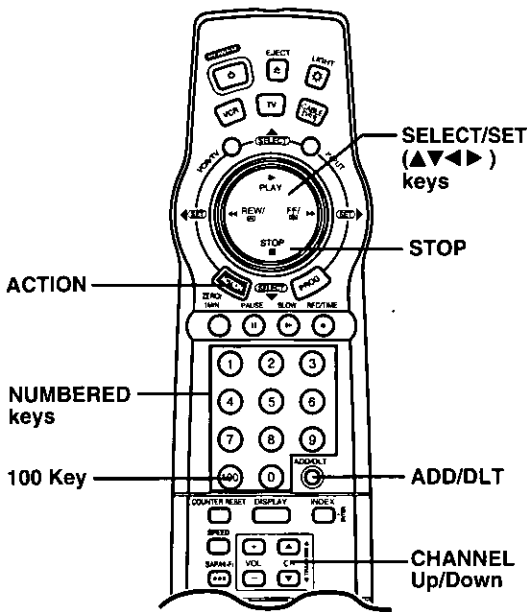

To Add or Delete a Channel

- 1 Select a channel using the NUMBERED keys to add or CH ▲/▼ to delete.
- 2 Press ADD/HLT to add or delete the channel.
 - To select a channel once it's deleted, use the NUMBERED keys on the remote control.

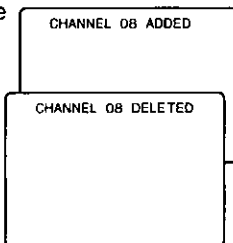

To Set or Reset the Clock

In case the clock is wrong, or a power failure occurred.

- 1 Press ACTION to display the menu.
- 2 Press ▲▼ to select "SET CLOCK," and then press ► to display the "SET CLOCK" screen.
- 3 Press ▲▼ to select "MANUAL," and then press ► to display the SET CLOCK screen.
- 4 Press ▲▼ and ◀▶ to select and set the date, time and DST. (Daylight Saving Time).
- 5 Press ACTION twice to start the clock and exit this mode.

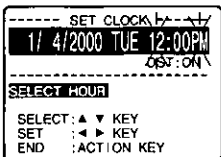
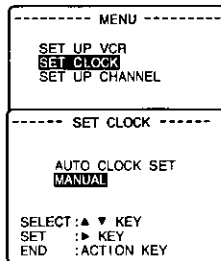

- For Auto Clock Set, select "AUTO CLOCK SET," and then follow the One Time D-VHS VCR Setup instructions on pages 12-14.

To Replace Channels in Memory

In case you have cable installed, etc.

- 1 Press ACTION to display the menu.
- 2 Press ▲▼ to select "SET UP CHANNEL," and then press ► to display the "SET UP CHANNEL" screen.
- 3 Press ▲▼ to select "ANTENNA," and then press ► to set your antenna system (TV or CABLE).
- 4 Press ▲▼ to select "AUTO SET," and then press ► to display the "CHANNEL/CLOCK AUTO SET" screen.
- 5 Follow the One Time D-VHS VCR Setup instructions on pages 12-14.
 - Clock Auto Set will be performed when channels are replaced in memory.

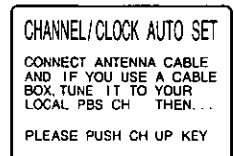
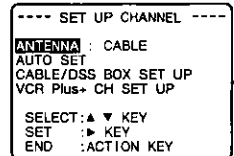
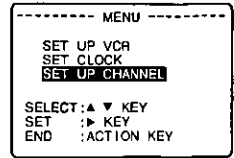

- To cancel, press STOP when "AUTO CLOCK SET PROCEEDING" appears on-screen.

To Setup the D-VHS VCR in Case a Cable Box or DSS Receiver was Installed or Replaced

- 1 Press ACTION to display the menu.
- 2 Press ▲▼ to select "SET UP CHANNEL," and then press ► to display the "SET UP CHANNEL" screen.
- 3 Press ▲▼ and ▼ to select and set "CABLE/ DSS BOX SET UP," and then select and set your connection type.
 - If you selected "NO," go to "Alternate Instructions" on page 14.
 - To exit this mode, press ACTION three times.
- 4 Press ▲▼ and ► to select and set "CABLE/DSS BOX ► VCR ► TV," and then continue with steps 4-7 on pages 12, 13.

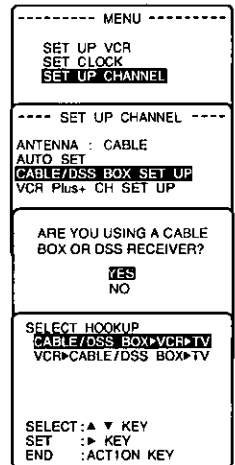

If these steps are completed, the "SET UP CHANNEL" screen will appear.

When Using the 100 key

When selecting CABLE channels 100 to 125 with the NUMBERED keys, first press the 100 key and then enter the remaining two digits. For example, to select channel 125: Press NUMBERED keys 100, then 2, then 5.

NOTES

- Some screens shown above may not be displayed during digital playback.
- This D-VHS VCR will accurately maintain its calendar up to Dec. 31, 2097, 11:59PM.
- Normal TV or Cable channels are automatically selected and placed in memory depending on how your D-VHS VCR is hooked up.
- If you change your Cable Box or DSS Receiver, please perform the "Auto Clock Set" section on pages 12 and 13.

D-VHS VCR & Cassette Information

Reset all D-VHS VCR Memory Functions

Use when moving the D-VHS VCR to a new location, or if a mistake was made in the One Time D-VHS VCR Setup section.

- Make sure a tape is not inserted in the D-VHS VCR.

- 1 Turn D-VHS VCR Power on.



- 2 Press and hold both PLAY and CHANNEL ▲ on the D-VHS VCR for more than 5 seconds.
 - The power will shut.

- 3 Perform the One Time D-VHS VCR Setup section on page 12.

To prevent accidental erasure a recorded tape

Break off the tab.

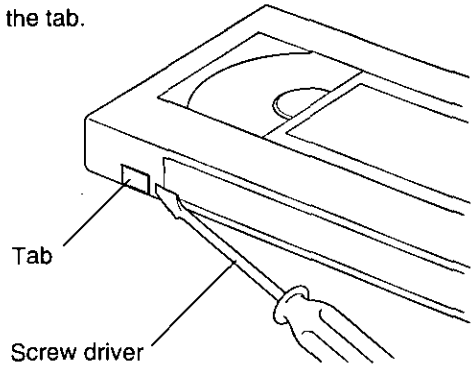

To record again

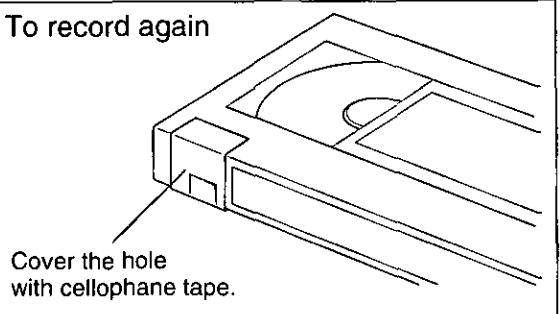

D.S.T. (Daylight Saving Time)

Your D-VHS VCR can be set to automatically adjust the clock for Daylight Saving Time.

Spring (First Sunday in April)

When the D-VHS VCR is set to DST:ON, it automatically adds one hour.

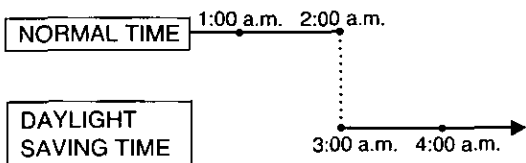

Autumn (Last Sunday in October)

When the D-VHS VCR is set to DST:ON, it automatically turns back one hour.

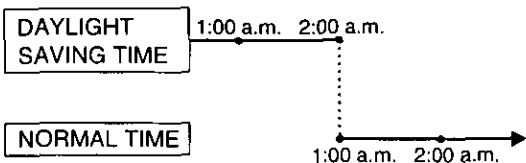

- If your area does not observe Daylight Saving Time, select DST:OFF.
- Keep these time changes in mind when programming the D-VHS VCR for timer recordings.

Record/Playback Time

Only use tapes with the **VHS** or **DVHS** mark in this unit.

Tape Speed Setting	VHS Type of Video Cassette		
	T60	T120	T160
SP (Standard Play)	1 Hour	2 Hours	2 Hours 40 Minutes
LP (Long Play)	2 Hours	4 Hours	5 Hours 20 Minutes
SLP (Super Long Play)	3 Hours	6 Hours	8 Hours

Tape Speed Setting	DVHS Type of Video Cassette	
	DF-300	DF-420
STD (Standard)	5 Hours	7 Hours
HS (High Speed)	2 Hours 30 Minutes	3 Hours 30 Minutes

Built-in Head Cleaner

A clean video head helps produce a clear picture. So, we have equipped your D-VHS VCR with a built-in, non chemical head cleaning system that helps prevent clogging of the video heads. Cleaning is performed each time you load or unload a video cassette.

NOTE: This feature is preventative only. If your video heads are seriously clogged, consider the use of a chemical nonabrasive head cleaning kit.

Cleaning the D-VHS VCR

Use a soft cloth or dusting attachment of your vacuum cleaner to dust your D-VHS VCR. Remove dust from the ventilation holes on the back sides and bottom of the cabinet.

Plastic surfaces are easily scratched and can be marred by alcohol and various solvents. Avoid excessive use of oil-based furniture polishes since the materials used in the cabinet will accumulate more dust. We recommend using a nonabrasive, antistatic cleaner and polisher.

FCC Warning: To assure continued FCC compliance, the user must use only provided shielded interfacing cable with ferrite cores when connecting to the Set Top Box. Also, any unauthorized changes or modifications to this equipment would void the users authority to operate.

Declaration of Conformity

Model Number : PV-HD1000
Trade Name : **Panasonic**
Responsibility Party : Matsushita Electric Corporation of America
Address : One Panasonic Way
Secaucus New Jersey
07094
Telephone Number : 1-800-211-PANA (7262)

This device complies with Part 15 of the FCC Rules. Operation is subject to the following two conditions:

(1) This device may not cause harmful interference, and (2) this device must accept any interference received, including interference that may cause undesired operation.

Specifications

Power Source: 120V AC, 60 Hz
Power Consumption: Approx. 33 watts (Power on)
Approx. 8.9 watts (Power off)

VHS

Video Signal: EIA Standard NTSC color
Video Recording System : 4 rotary heads helical scanning system
Audio Track: 1 track (Normal)
2 channel (Hi-Fi Audio Sound)

Tuner:

Broadcast Channels: VHF 2-13, UHF 14-69
CABLE Channels: Midband A through I (14-22)
Superband J through W (23-36)
Hyperband AA-EEE (37-64)
Lowband A-5-A-1 (95-99)
Special CABLE channel 5A (01)
Ultraband 65-94, 100-125

D-VHS

Video/Audio Signal: MPEG2-TS (Transport stream)

Video/Audio Recording

System: 4 rotary heads for Video and Audio

Operating Temperature: 41°F-104°F (5°C-40°C)

Operating Humidity: 10%-75%

Weight: 4.7 kg (10.4 lbs.)

Dimensions: 16-15/16" (W) x 3-7/16" (H) x 11-1/2" (D)
430 (W) x 89 (H) x 292 (D) mm

Note: Designs and specifications are subject to change without notice.

On-Screen Displays (OSD)

***Important:** If the remote control POWER, ACTION, PROG, CH▲▼, INDEX or ADD/HLT button does not work when pressed, press the VCR button on the remote and try the button again.

Function & Channel Display

When a function button is pressed, e.g. PLAY, or you change channels, a 4 second display appears first in large and then small characters. (Some station names may also appear.)

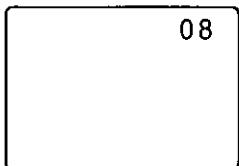

Menu Screen

1 Press ACTION* to display the menu.

2 Press ▲▼ and ► to make your selection.

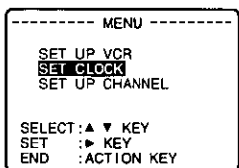

- To get the most from each feature, please read the Operating Manual before attempting any operation.

D-VHS VCR Status & Clock Display

Press DISPLAY to display or remove the overlay shown below.

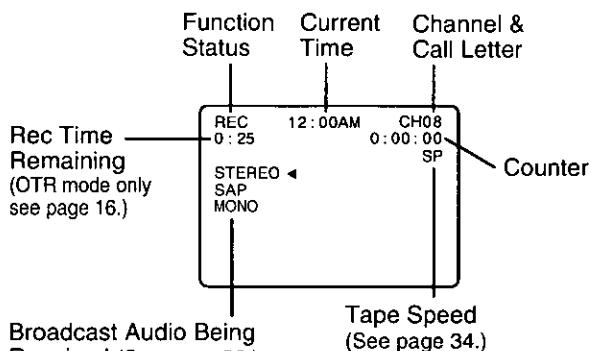

- This display will disappear in 5 seconds.

Blank Tape/ No Video Signal Indication

Whenever a blank section of a tape comes up in Play mode, or when the selected channel has no broadcast signal, the TV screen will turn solid blue.

Warning and Instruction Displays

These displays will alert you of a missed operation or provide further instructions.

If no active channels are found for CHANNEL MEMORY... (See page 14.)

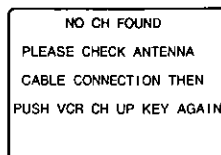

If you attempt to set or review a Timer Recording and the Clock is not set... (See page 20.)

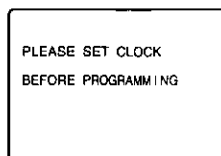

After a Timer Program has been set... (See page 20.)

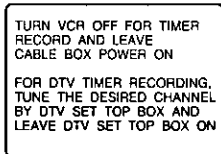

If you press REC on the remote control or D-VHS VCR, and a cassette is inserted with no record tab... (See pages 16, 34.)

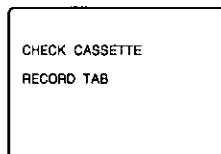

If you press PLAY, FF, REW, or REC on the remote control or D-VHS VCR without a cassette inserted... (See pages 15, 16.)

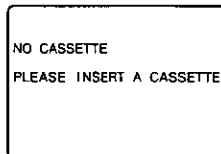

If you press POWER or STOP during a Timer Recording... (visible in VCR mode only) (See page 21.)



If you press a function button other than STOP/EJECT or POWER on the D-VHS VCR, or STOP or EJECT or POWER on the remote control while the D-VHS VCR is in VCR Lock mode... (See page 32.)

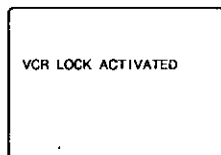

If you press POWER, ACTION or PROG on the remote while in TV or CABLE/DSS mode... (See pages 24, 25.)

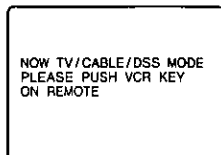

- In digital playback mode, some screens shown here may not be displayed.

Before Requesting Service

Check the following points once again if you are having trouble with your D-VHS VCR.

Power	Correction
No power...	<ul style="list-style-type: none"> • Completely insert the Power Plug into an AC outlet. • Set the POWER button to ON.
Recording & Playback	Correction
TV program cannot be recorded...	<ul style="list-style-type: none"> • Check connections between D-VHS VCR, external antenna, and your TV. • Make sure your antenna system (CABLE or TV) is correctly set. (To Replace Channels in Memory [P.33]) • Make sure that the record tab is intact on the cassette. (P.34) • Check the Multi Function Display. If "CP" is displayed, the digital program has copy protected data and cannot be recorded. (P.19)
Timer recording cannot be performed...	<ul style="list-style-type: none"> • Set the recording start/stop times correctly. (P.20) • Make sure Cable/DSS box or set top box (if used) is left on and tuned to the program to be recorded. (P.20) • Make sure that the POWER button is set to OFF. (P.20) • Timer recording may not be performed or continued if a power interruption of more than 1 minute occurs before, or during, a Timer Recording, even after power is restored.
There is no playback picture, or the playback picture is noisy or contains streaks...	<ul style="list-style-type: none"> • Select channel 3 or 4 on the TV to match the Channel 3/4 switch located on the rear panel of the D-VHS VCR. (P.6) • Set the VCR/TV selector to "VCR." • Check that channel 3 or 4 of the TV is properly tuned in. • Adjust the TRACKING control in either direction. (P.15) • The black screen is displayed when playback digital program which have copy protect data.
"NOT PRESENT" is displayed on the screen, even though connections are made correctly...	<ul style="list-style-type: none"> • Turn the Set Top Box* power off and then on again.
The picture is not displayed during digital playback...	<ul style="list-style-type: none"> • Turn the Set Top Box* power off and then on again.
"INPUT SIGNAL NOT FOUND" is displayed on the screen and/or "SnF" is displayed in the Multi Function Display during digital recording...	<ul style="list-style-type: none"> • Make sure the IEEE1394 cable is properly connected. • Turn the Set Top Box* power off and then on again.
Special effects playback, picture may contain some vertical jitter when using a TV with an Automatic Vertical Hold Control...	<ul style="list-style-type: none"> • Set the TV's Vertical Hold Control to "MANUAL" and then adjust it.
D-VHS VCR cannot be controlled...	<ul style="list-style-type: none"> • Make sure that VCR LOCK is set to off. (P.32)
Remote Control	Correction
D-VHS VCR cannot be remote controlled...	<ul style="list-style-type: none"> • When "ACT" or "PRG" in the Multi Function Display is displayed, press ACTION or PROG to exit. (P.6-7) • Aim the Remote Control directly at the remote sensor on the D-VHS VCR. (P.42) • Avoid all obstacles which may interfere with the signal path. • Inspect the remote batteries for possible replacement. (P.4) • Make sure that VCR LOCK is set to off. (P.32) • Exposing the D-VHS VCR remote sensor to direct fluorescent or outdoor light may cause signal interference.
ACTION and PROG buttons cannot be used...	<ul style="list-style-type: none"> • Press the VCR button to select VCR mode. (P.25)
Miscellaneous	Correction
Programs cannot be viewed on TV...	<ul style="list-style-type: none"> • Set the VCR/TV selector to "TV." (P.17)
On Screen display such as MENU or PROGRAM cannot be displayed...	<ul style="list-style-type: none"> • Some screens cannot be displayed during digital playback. • Connect the D-VHS VCR to the DTV compatible TV.
Video cassette cannot be inserted...	<ul style="list-style-type: none"> • Insert the cassette with window side up; record tab facing you.
Video cassette cannot be removed...	<ul style="list-style-type: none"> • Completely insert the Power Plug into an AC wall outlet.
Video cassette ejects when a recording is started or the power is turned off for timer recording...	<ul style="list-style-type: none"> • Make sure the record tab is intact on the cassette. (P.34)
In Stop mode, the motor (CYLINDER) continues to rotate...	<ul style="list-style-type: none"> • To enable the quick play mechanism, the cylinder will rotate for about 5 minutes. This reduces response time from Stop to Play mode from Play to Rewind Search mode.
The top of the playback picture waves back and forth excessively...	<ul style="list-style-type: none"> • Because the D-VHS VCR playback signal is not as stable as an off-the-air TV signal, the top of your TV screen may be bent or unstable during playback. Slowly turn the horizontal hold control on your TV to correct the wavy picture. If your TV does not have a horizontal hold control or adjusting the control does not help, please contact your local TV service center.

*When using the Set Top Box TU-DST50 only.

If you cannot resolve the problem, please call the Customer Satisfaction Center for product assistance at 201-348-9090.

To locate an authorized servicenter, please call toll free 1-800-211-PANA (7262).

Service Center List

For Product Information, Operating Assistance, Literature Request, Dealer Locations, and all Customer Service inquiries please contact:

1-800-211-PANA (7262), Monday-Friday 9am-9pm Saturday-Sunday 9am-7pm, EST.

Web Site: <http://www.panasonic.com>

You can purchase parts, accessories or locate your nearest servicer by visiting our Web Site.

Accessory Purchases:

Customer Orders Only 800-332-5368 (Customer Orders Only)

Panasonic Services Company 20421 84th Avenue South, Kent, WA 98032

(6 am to 5 pm Monday - Friday; 6 am to 10:30 am Saturday; PST)

(Visa, MasterCard, Discover Card, American Express, Check)

Factory Servicenters Locations

CALIFORNIA

6550 Katella Avenue
Cypress, CA 90630

800 Dubuque Avenue
S. San Francisco,
CA 94080

20201 Sherman Way
Suite 102
Canoga Park, CA 91306

3878 Ruffin Road
Suite A
San Diego, CA 92123

COLORADO

1640 South Abilene Street
Suite D
Aurora, CO 80012

FLORIDA

3700 North 29th Avenue
Suite 102
Hollywood, FL 33020

GEORGIA

8655 Roswell Road
Suite 100
Atlanta, GA 30350

ILLINOIS

9060 Golf Road
Niles, IL 60714

1703 North Randall
Road
Elgin, IL 60123
(Pick-up / Drop-off only)

MARYLAND

62 Mountain Road
Glen Burnie, MD 21061

MASSACHUSETTS

60 Glacier Drive
Suite G
Westwood, MA 02090

MICHIGAN

37048 Van Dyke Avenue
Sterling Heights, MI 48312

MINNESOTA

7850-12th Avenue South
Airport Business Center
Bloomington, MN 55425

OHIO

2236 Waycross Road
Civic Center Plaza
Forest Park, OH 45240

PENNSYLVANIA

2221 Cabot Blvd. West
Suite B
Langhorne, PA 19047

Chartiers Valley
Shopping Center
1025 Washington Pike
Bridgeville, PA 15017

TENNESSEE

3800 Ezell Road
Suite 806
Nashville, TN 37211

TEXAS

7482 Harwin Drive
Houston, TX 77036

13615 Welch Road
Suite 101
Farmers Branch,
TX 75244

WASHINGTON

20425-84th Avenue South
Kent, WA 98032

HAWAII

99-859 Iwaiwa Street
Aiea, Hawaii 96701
Phone (808)488-1996
Fax (808)486-4369

Service in Puerto Rico

Matsushita Electric of Puerto Rico, Inc. Panasonic Sales Company/ Factory Servicer:

Ave. 65 de Infanteria, Km. 9.5, San Gabriel Industrial Park, Carolina, Puerto Rico 00985

Phone (787)750-4300 Fax (787)768-2910

Warranty

Panasonic Consumer Electronics Company,
Division of Matsushita Electric Corporation
of America,
One Panasonic Way
Secaucus, New Jersey 07094

Panasonic Sales Company,
Division of Matsushita Electric of Puerto Rico, Inc.
AVE. 65 de Infantería, Km. 9.5
San Gabriel Industrial Park
Carolina, Puerto Rico 00985

PANASONIC Video Products Limited Warranty

Panasonic Consumer Electronics Company or Panasonic Sales Company (collectively referred to as "the Warrantor") will repair this product with new or refurbished parts, free of charge, in the USA or Puerto Rico, in the event of a defect in materials or workmanship as follows (all time periods commence from the date of the original purchase):

<u>PRODUCT</u>	<u>PARTS</u>	<u>LABOR</u>
CAMCORDER	ONE (1) YEAR, EXCEPT CCD IMAGE SENSOR CCD IMAGE SENSOR - SIX (6) MONTHS	NINETY (90) DAYS NINETY (90) DAYS
VCR	ONE (1) YEAR	NINETY (90) DAYS
A/V MIXER	ONE (1) YEAR	NINETY (90) DAYS
MONITOR-VCR	ONE (1) YEAR, EXCEPT CRT CRT - TWO (2) YEARS	NINETY (90) DAYS CRT - NINETY (90) DAYS CUSTOMER PAYS ALL LABOR CHARGES AFTER 90 DAYS

Monitor-VCR In-home or carry-in Service: 22" (diagonal) CRT / LCD and Larger
Monitor-VCR Carry-in Service: 21" (diagonal) CRT / LCD and smaller

Batteries (if included) - New rechargeable batteries in exchange for defective rechargeable batteries for ten (10) days. Non-rechargeable batteries are not warranted.

Tape (if included) - New video cassette tape in exchange for a defective video cassette tape for five (5) days.

In-home, carry-in or mail-in service, as applicable, in the USA can be obtained during the warranty period by contacting a Panasonic Services Company (PASC) Factory Servicenter listed in the Service Directory. Or call toll free 1-800-211-PANA (7262), to locate an authorized PASC Servicenter. Carry-in or mail-in service in Puerto Rico can be obtained during the warranty period by calling the Panasonic Sales Company telephone number listed in the Servicenter Directory.

This warranty is extended only to the original purchaser. A purchase receipt or other proof of the date of the original purchase is required before warranty service is rendered.

This warranty only covers failures due to defects in materials and workmanship which occur during normal use and does not cover normal maintenance, including, but not limited to, video and audio head cleaning. The warranty does not cover damage which occurs in shipment, or failures which are caused by products not supplied by the warrantor, or failures which result from accident, misuse, abuse, neglect, mishandling, misapplication, alteration, modification, faulty installation, set-up adjustments, improper antenna, inadequate signal pickup, maladjustment of consumer controls, improper operation, power line surge, improper voltage supply, lightning damage, commercial use such as hotel, office, restaurant, or other business or rental use of the product, or service by anyone other than a PASC Factory Servicenter or a PASC authorized Servicenter, or damage that is attributable to acts of God.

LIMITS AND EXCLUSIONS

There are no express warranties except as listed above.

THE WARRANTOR SHALL NOT BE LIABLE FOR INCIDENTAL OR CONSEQUENTIAL DAMAGES (INCLUDING, WITHOUT LIMITATION, DAMAGE TO TAPES) RESULTING FROM THE USE OF THIS PRODUCTS, OR ARISING OUT OF ANY BREACH OF THE WARRANTY. ALL EXPRESS AND IMPLIED WARRANTIES, INCLUDING THE WARRANTIES OF MERCHANTABILITY AND FITNESS FOR PARTICULAR PURPOSE, ARE LIMITED TO THE APPLICABLE WARRANTY PERIOD SET FORTH ABOVE. Some states do not allow the exclusion or limitation of incidental or consequential damages, or limitations on how long an implied warranty lasts, so the above exclusions or limitations may not apply to you.

This warranty gives you specific legal rights and you may also have other rights which vary from state to state.

If a problem with this product develops during or after the warranty period, you may contact your dealer or Servicenter. If the problem is not handled to your satisfaction, then write to the Customer Satisfaction Center at the Panasonic Consumer Electronics Company address above.

SERVICE CALLS WHICH DO NOT INVOLVE DEFECTIVE MATERIALS OR WORKMANSHIP AS DETERMINED BY THE WARRANTOR, IN ITS SOLE DISCRETION, ARE NOT COVERED. COSTS OF SUCH SERVICE CALLS ARE THE RESPONSIBILITY OF THE PURCHASER.

warvid 10/20/97

Para ajustar el lenguaje, el sintonizador de cable/DSS, los canales y el reloj automático

1 Encienda el televisor y la videogradora.

2 Sintonice el televisor al canal de salida de la videogradora (el mismo canal que ha fijado en la parte trasera de la videogradora; canal 3 o 4).

- Si esta usando los terminales de audio/video para su conexión, fije el televisor al modo de entrada de video.

3 Oprimir **▲▼** para seleccionar el tipo de conexión y luego oprimir **▶** para ajustar.

- Si utiliza una caja de cable o un receptor DSS y selecciona "YES", diríjase al paso 4.
- Si ha seleccionado "NO", en la pantalla se visualizará "CABLE BOX CONTROL IS NOT AVAILABLE". Diríjase a "Instrucciones Alternativas", en la página 41.

ARE YOU USING A CABLE BOX OR DSS RECEIVER?

YES
NO

SELECT: ▲ ▼ KEY
SET : ▶ KEY
END : ACTION KEY

4 Oprimir **▲▼** para elegir, y luego oprimir **▶** para fijar su conexión.

- Si ud. ha elegido CABLE/DSS **▶** VCR **▶** TV, continúe al paso 5. De lo contrario, vaya a la sección "Instrucciones alternativas" en la página 41.
- Si está usando el método de conexión CABLE/DSS BOX **▶** VCR **▶** TV, sólo el canal de salida del cable será memorizado.

SELECT HOOKUP

CABLE/DSS BOX **▶** VCR **▶** TV
VCR **▶** CABLE/DSS BOX **▶** TV

SELECT: ▲ ▼ KEY
SET : ▶ KEY
END : ACTION KEY

5 Oprimir **▲▼** para elegir el canal de salida de la caja de TV por cable o el receptor DSS, y luego oprimir **▶** para fijar.

- Si es necesario, consulte su manual de la caja de TV por cable.
- Si ud. está usando los terminales de audio/video para la conexión de la caja de TV por cable, elija y fije a "VIDEO OUT" para el canal de salida.

SELECT HOOKUP

CABLE/DSS BOX **▶** VCR **▶** TV

CABLE/DSS BOX OUTPUT CH
CH 01

SELECT: ▲ ▼ KEY
SET : ▶ KEY
END : ACTION KEY

6 Oprimir **▲▼** para elegir el número de código de la caja de TV por cable o el receptor DSS, y luego oprimir **▶** para fijar. (Consulte su lista de la página 11.)

- Si su caja de TV por cable o su receptor DSS no tiene un control remoto, elija "NO REMOTE."
- De esta manera se determina si el videogradora va a controlar el sintonizador de cable o DSS.

ENTER CODE NUMBER REFERRING TO MANUAL

01

SELECT: ▲ ▼ KEY
SET : ▶ KEY
END : ACTION KEY

Si ud. usa una caja de TV por cable, sintonice al canal 2. Si usa un receptor DSS, sintonice al canal 270.

7 Oprimir **▶** para continuar.

- "NOW TRANSMITTING" aparece.

Caja de TV

PLEASE TUNE YOUR CABLE BOX TO CH02.

Receptor DSS

PLEASE TUNE YOUR DSS RECEIVER TO CH 270.

PROCEED: ▶ KEY
END : ACTION KEY

8 Oprimir **▲▼** para elegir "YES" o "NO," y luego oprimir **▶** para fijar.

Si ud. usa una caja de TV por cable y ha elegido "YES," siga al paso 9.

Si ud. usa un receptor DSS y ha elegido "YES," siga las instrucciones alternativas de la página 41.

Si ha elegido "NO," aparecerá de nuevo la pantalla del paso 6. Intente fijar un código diferente para su marca y/o cambie la conexión de su equipo. Si su respuesta es todavía "NO," el control de la caja de TV por cable o el receptor DSS no es disponible.

Caja de TV

IS YOUR CABLE BOX RECEIVING CH 09 ?

YES
NO

Receptor DSS

IS YOUR DSS RECEIVER RECEIVING CH 200 ?

YES
NO

SELECT: ▲ ▼ KEY
SET : ▶ KEY
END : ACTION KEY

Verifique que su caja de TV por cable esté encendido y su receptor DSS esté apagado.

9 Oprimir **▲▼** para elegir el canal PBS de su local que está recibiendo en su caja de TV por cable, y luego oprimir **▶** para que aparezca la pantalla "CLOCK AUTO SET."

PLEASE ENTER YOUR LOCAL PBS CHANNEL ON CABLE BOX

CH 01

SELECT: ▲ ▼ KEY
SET : ▶ KEY
END : ACTION KEY

10 Oprimir **CH ▲** para iniciar la fijación automática del reloj.

- Si ud. vive cerca de una zona con diferente hora, fije el canal de su zona.
- "AUTO CLOCK SET PROCEEDING" aparece.

CLOCK AUTO SET

CONNECT ANTENNA CABLE AND IF YOU USE A CABLE BOX, TUNE IT TO YOUR LOCAL PBS CH THEN...

PLEASE PUSH CH UP KEY

11 Esta pantalla aparece cuando la fijación automática del reloj es completo.

Comprobar si la hora está fijada correctamente y luego oprimir **CH ▲** para terminar la fijación.

11/ 4/2000 TUE 12:00PM

DST: ON

SETTING : CH 02

AUTO CLOCK SET COMPLETED

END : PUSH CH UP KEY

Para ajustar el lenguaje, el sintonizador de cable/DSS, los canales y el reloj automático

1 Encienda el televisor y la videograbadora.

2 Sintonice el televisor al canal de salida de la videograbadora (el mismo canal que ha fijado en la parte trasera de la videograbadora; canal 3 o 4).

- Si esta usando los terminales de audio/video para su conexión, fije el televisor al modo de entrada de video.

3 Oprimir **▲▼** para seleccionar el tipo de conexión y luego oprimir **▶** para ajustar.

- Si utiliza una caja de cable o un receptor DSS y selecciona "YES", diríjase al paso 4.

- Si ha seleccionado "NO", en la pantalla se visualizará "CABLE BOX CONTROL IS NOT AVAILABLE". Diríjase a "Instrucciones Alternativas", en la página 41.

ARE YOU USING A CABLE BOX OR DSS RECEIVER?
YES
NO

SELECT: ▲ ▼ KEY
 SET : ▶ KEY
 END : ACTION KEY

4 Oprimir **▲▼** para elegir, y luego oprimir **▶** para fijar su conexión.

- Si ud. ha elegido CABLE/DSS ▶ VCR ▶ TV, continúe al paso 5.

De lo contrario, vaya a la sección "Instrucciones alternativas" en la página 41.

- Si está usando el método de conexión CABLE/DSS BOX ▶ VCR ▶ TV, sólo el canal de salida del cable será memorizado.

SELECT HOOKUP
 CABLE/DSS BOX ▶ VCR ▶ TV
 VCR ▶ CABLE/DSS BOX ▶ TV

SELECT: ▲ ▼ KEY
 SET : ▶ KEY
 END : ACTION KEY

5 Oprimir **▲▼** para elegir el canal de salida de la caja de TV por cable o el receptor DSS, y luego oprimir **▶** para fijar.

- Si es necesario, consulte su manual de la caja de TV por cable.

- Si ud. está usando los terminales de audio/video para la conexión de la caja de TV por cable, elija y fije a "VIDEO OUT" para el canal de salida.

SELECT HOOKUP
 CABLE/DSS BOX ▶ VCR ▶ TV

CABLE/DSS BOX OUTPUT CH
CH 01

SELECT: ▲ ▼ KEY
 SET : ▶ KEY
 END : ACTION KEY

6 Oprimir **▲▼** para elegir el número de código de la caja de TV por cable o el receptor DSS, y luego oprimir **▶** para fijar. (Consulte su lista de la página 11.)

- Si su caja de TV por cable o su receptor DSS no tiene un control remoto, elija "NO REMOTE."

- De esta manera se determina si el videograbador va a controlar el sintonizador de cable o DSS.

ENTER CODE NUMBER
 REFERRING TO MANUAL

01

SELECT: ▲ ▼ KEY
 SET : ▶ KEY
 END : ACTION KEY

Si ud. usa una caja de TV por cable, sintonice al canal 2. Si usa un receptor DSS, sintonice al canal 270.

7 Oprimir **▶** para continuar.

- "NOW TRANSMITTING" aparece.

Caja de TV

PLEASE TUNE YOUR CABLE BOX TO CH02.

Receptor DSS

PLEASE TUNE YOUR DSS RECEIVER TO CH 270.

PROCEED: ▶ KEY
 END : ACTION KEY

8 Oprimir **▲▼** para elegir "YES" o "NO," y luego oprimir **▶** para fijar.

Si ud. usa una caja de TV por cable y ha elegido "YES," siga al paso 9.

Si ud. usa un receptor DSS y ha elegido "YES," siga las instrucciones alternativas de la página 41.

Si ha elegido "NO,"

aparecerá de nuevo la pantalla del paso 6.

Intente fijar un código diferente para su marca y/o cambie la conexión de su equipo.

Si su respuesta es todavía "NO," el control de la caja de TV por cable o el receptor DSS no es disponible.

Caja de TV

IS YOUR CABLE BOX RECEIVING CH 09 ?

YES
NO

Receptor DSS

IS YOUR DSS RECEIVER RECEIVING CH 200?

YES
NO

SELECT: ▲ ▼ KEY
 SET : ▶ KEY
 END : ACTION KEY

Verifique que su caja de TV por cable esté encendido y su receptor DSS esté apagado.

9 Oprimir **▲▼** para elegir el canal PBS de su local que está recibiendo en su caja de TV por cable, y luego oprimir **▶** para que aparezca la pantalla "CLOCK AUTO SET."

PLEASE ENTER YOUR LOCAL PBS CHANNEL ON CABLE BOX

CH 01

SELECT: ▲ ▼ KEY
 SET : ▶ KEY
 END : ACTION KEY

10 Oprimir **CH ▲** para iniciar la fijación automática del reloj.

- Si ud. vive cerca de una zona con diferente hora, fije el canal de su zona.

- "AUTO CLOCK SET PROCEEDING" aparece.

CLOCK AUTO SET

CONNECT ANTENNA CABLE AND IF YOU USE A CABLE BOX, TUNE IT TO YOUR LOCAL PBS CH THEN...

PLEASE PUSH CH UP KEY

11 Esta pantalla aparece cuando la fijación automática del reloj es completo.

Comprobar si la hora está fijada correctamente y luego oprimir **CH ▲** para terminar la fijación.

11/ 4/2000 TUE 12:00PM
 DST: ON
 SETTING : CH 02
 AUTO CLOCK SET
 COMPLETED
 END : PUSH CH UP KEY

Si la hora fijada automáticamente es incorrecto

Si ud. usa una caja de TV por cable y recibe emisiones de más de un canal PBS, intente fijar automáticamente otravez. Siga las instrucciones de "Para fijar o fijar de nuevo el reloj" en la página 42 y cuando las instrucciones de la pantalla requiere la fijación del canal PBS, fije un canal que no ha intentado anteriormente.

Si aparece en la pantalla FIJACION DEL RELOJ INCOMPLETO

La pantalla siguiente aparecerá si no es disponible en su zona la fijación automática de la hora.

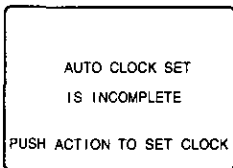

Presione ACTION para exhibir la pantalla "SET CLOCK" (manual), y luego realice los pasos B y C en la página 41.

Notas:

Si ud. usa una caja de TV por cable y recibe emisiones de más de un canal PBS, ud. debe salir desde la pantalla de la fijación del reloj manual e intente fijar automáticamente otravez. Siga la "Para fijar o fijar de nuevo el reloj" en la página 42 y cuando las instrucciones de la pantalla requiere la fijación del canal PBS, fije un canal que no ha intentado anteriormente.

NOTA

La fijación automática de la hora se efectuará cada día al apagar la videograbadora por primera vez. Si ud. usa una caja de TV por cable y desea efectuar la fijación automática de la hora, la caja de TV por cable debe permanecer encendido y sintonizado al canal PBS cuando la videograbadora se apaga.

Instrucciones alternativas

Complete los siguientes pasos si ha efectuado una de las siguientes explicaciones.

- Ud. ha elegido la segunda conexión (VCR▶CABLE/DSS▶TV) en el paso 4 de la página 44.
- Ud. ha elegido "NO REMOTE" en el paso 6 de la página 40 (su caja de TV por cable o receptor DSS no tiene un control remoto).
- Ud. está usando un receptor DSS y ha elegido "YES" en el paso 8 de la página 40.

1 Encienda la caja de TV por cable y fije la caja de TV por cable al canal PBS de su local.

- Si ud. vive cerca de una zona con diferente hora, asegúrese de fijar el canal de su zona.
- Si ud. usa un receptor DSS, éste debe estar apagado.

CHANNEL/CLOCK AUTO SET

CONNECT ANTENNA CABLE AND IF YOU USE A CABLE BOX, TUNE IT TO YOUR LOCAL PBS CH THEN...

PLEASE PUSH CH UP KEY

2 Oprimir CH ▲ para iniciar la fijación automática de los canales y la fijación de la hora.

- Aparece las siguientes informaciones: "CH AUTO SET PROCEEDING" "AUTO CLOCK SET PROCEEDING"

Esta pantalla aparece para informarle que la fijación automática de la hora es incompleto.

3 Comprobar si la hora está fijada correctamente y luego oprimir CH ▲ para terminar la fijación.

Si aparece esta pantalla, la fijación automática no es disponible en su zona. Ajuste el reloj a mano tal como se describe a continuación.

1/ 4/2000 TUE 12:00PM

DST:ON
SETTING : CH 02

AUTO CLOCK SET
COMPLETED

END : PUSH CH UP KEY

AUTO CLOCK SET
IS INCOMPLETE

PUSH ACTION TO SET CLOCK

A Oprimir ACTION para que aparezca la pantalla de la fijación del reloj.

B Oprimir ▲▼ y ◀▶ para elegir y fijar el mes, la fecha, el año, la hora y la hora veraniega.

Para hacer correcciones

Oprimir ◀▶ sucesivamente para avanzar o para retroceder hasta el paso que desea corregir.

C Oprimir ACTION dos veces para iniciar a funcionar el reloj y salir desde este modo.

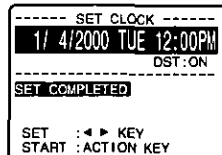
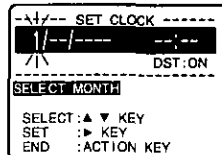

Si la hora y la hora veraniega es incorrecta. Raras veces, en caso de que ud. vive cerca de dos zonas con hora diferente, el aparato puede elegir un canal PBS con diferente hora de su zona. En este caso, haga los siguientes pasos:

- a Tome nota del canal que está fijado en la pantalla y salga desde este modo oprimiendo el botón CH ▲.
- b Anule este canal desde los canales memorizados en el videograbador.
- c Oprimir el botón ACTION para que aparezca la pantalla del menú.
- d Oprimir ▲▼ para elegir "SET CLOCK" y luego oprimir ► para que aparezca la pantalla de "SET CLOCK."
- e Oprimir ▲▼ y para elegir y fijar "AUTO CLOCK SET".
- f Siga las instrucciones en la páginas 40 y 41.
 - Si ud. esta usando una caja de TV por cable y tiene muchos canales PBS, sintonize la caja de TV por cable a un canal PBS diferente e intente la fijación automática otravez.

Para fijar o fijar de nuevo el reloj

En caso de que el reloj es incorrecto o ha ocurrido un corte eléctrico.

- 1 Oprimir ACTION para que aparezca la pantalla del menú.

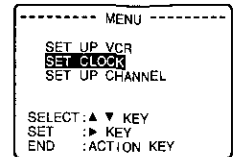

- 2 Oprimir ▲▼ para elegir "SET CLOCK" y luego oprimir ► para que aparezca la pantalla de "SET CLOCK."

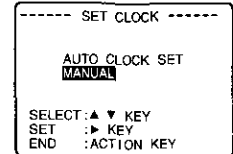

- 3 Oprimir ▲▼ para elegir "MANUAL," y luego oprimir ► para que aparezca la pantalla de la fijacion del reloj.

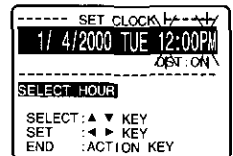

- 4 Oprimir ▲▼ y ◀▶ para elegir y fijar la hora y la fecha.

- 5 Oprimir ACTION dos veces para iniciar a funcionar el reloj y salir desde este modo.

- Para ajustar el reloj automático, seleccione "AUTO CLOCK SET" y luego siga las instrucciones en las páginas 40 y 41.

Operaciones para la reproducción de VHS

1 Introducir una casete.

- Esta indicación aparece en la pantalla multifuncional.

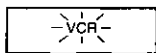

2 Oprimir PLAY en el control remoto o en la videograbadora para comenzar a reproducir.

- Si la cinta no tiene la lengüeta para evitar el borrado la videograbadora comienza a reproducir automáticamente.

3 Oprimir STOP en el control remoto o en la videograbadora para parar la reproducción.

4 Oprimir EJECT en el control remoto o en la videograbadora para expulsar la cinta.

- Usted puede expulsar la cinta cuando el aparato está encendido o apagado.

Para buscar una escena en particular durante la reproducción

Oprimir REW o FF durante la reproducción para buscar una escena.

- La velocidad de búsqueda es a 7 veces más rápida que la velocidad normal para el modo SP y 21 veces más rápida para el modo SLP.
- Durante la búsqueda aparece alguna barras de ruido.

Operaciones para la grabación de VHS

1 Introducir una casete con la lengüeta.

- La videograbadora se enciende automáticamente.



2 Oprimir CH ▲▼ o las teclas numéricas para elegir un canal.

- U oprimir CH ▲▼ en la videograbadora.
- Manteniendo presionado CH ▲▼ se aumentará la velocidad de búsqueda de canal.
- Para grabar desde una fuente externa, oprimir CH ▲▼ o INPUT para elegir "LINE."

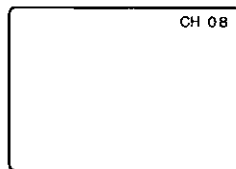

3 Oprimir SPEED para cambiar la velocidad de la cinta.

- SP = Reproducción estándar,
LP = Larga duración,
SLP = Superlarga duración.



4 Oprimir REC/TIME en el control remoto o videograbadora para empezar a grabar.

- Oprimir PAUSE para hacer una pausa en la grabación en progreso. Para continuar, vuelva a presionar PAUSE. (Después que el videograbador se encuentre en el modo de pausa durante 5 minutos, se detendrá automáticamente para proteger la cinta y los cabezales de vídeo.)

Grabación de un toque (OTR)

La videograbadora termina la grabación a una hora programada.

En el paso 4, oprimir repetidamente REC/TIME para fijar el tiempo de grabación. Cada presión cambiará la hora de parada como demuestra al siguiente.

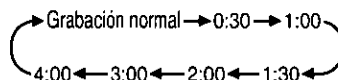

5 Oprimir STOP para parar la grabación. O, presione STOP/EJECT en el videograbador.

Operaciones para la reproducción de D-VHS (Digital)

1 Introducir una D-VHS casete.

- Esta indicación aparece en la pantalla multifuncional.

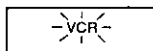

2 Oprimir PLAY en el control remoto o en la videograbadora para comenzar a reproducir.

- Si la cinta no tiene la lengüeta para evitar el borrado la videograbadora comienza a reproducir automáticamente.

3 Oprimir STOP en el control remoto o en la videograbadora para parar la reproducción.

4 Oprimir EJECT en el control remoto o en la videograbadora para expulsar la cinta.

- Usted puede expulsar la cinta cuando el aparato está encendido o apagado.

Operaciones para la grabación de D-VHS (Digital)

1 Introducir una D-VHS casete con la lengüeta.

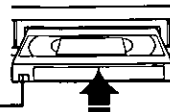

- La videograbadora se enciende automáticamente.

2 Seleccione un canal de grabación con la Caja Superior de Ajuste.

- Si fuera necesario remítase al manual de la Caja Superior de Ajuste.

3 Oprimir CH ▲▼ o INPUT para seleccionar "DTV".

4 Deslice el Interruptor D-VHS a la posición HS o HS/STD.

- A continuación se iluminará el indicador D-VHS.

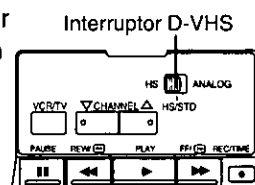

- HS: Se realizará la grabación digital. La velocidad de cinta es la del modo SP y el período de grabación es de 2 horas y media cuando se utiliza una cinta de DF-300.
- HS/STD: Se seleccionará automáticamente la grabación HS o STD (Normal). Cuando se selecciona STD, la velocidad de cinta será la del modo LP y el período de grabación será de unas 5 horas cuando se utilice una cinta de DF-300.
- ANALOG: Se realizará la grabación analógica. Para cambiar la velocidad de grabación deberá oprimir SPEED.

NOTA: Si utiliza la Caja Superior de Ajuste TU-DST50, deberá ajustar el interruptor D-VHS al modo HS.

5 Oprimir REC/TIME en el control remoto o videograbadora para empezar a grabar.

Grabación de un toque (OTR)

oprimir repetidamente REC/TIME para fijar el tiempo de grabación. Cada presión cambiará la hora de parada como demuestra al siguiente.

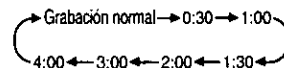

NOTA: Si da comienzo a la grabación con la función de comando de grabación de la Caja Superior de Ajuste, no podrá disponer de la función Grabación por Temporizador de Un Toque.

6 Oprimir STOP en el control remoto o videograbadora para parar la grabación.

NOTA: Los programas que incluyan datos de protección de copia no podrán grabarse.

Programación fácil para la grabación con temporizador

1 Oprimir PROG para que aparezca la pantalla "SET PROGRAM."

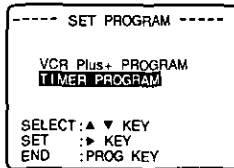

2 Oprimir ▲▼ para elegir "TIMER PROGRAM" y luego oprimir ▶ para exhibir la pantalla de la programación.

- Si ya existe una programación memorizada, oprimir ▲▼ y ▶ para elegir un número sin programación.

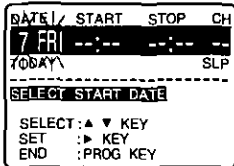

3 Oprimir ▲▼ y ▶ para elegir y fijar uno de los siguientes:

- 1-31 = Grabación de una sola vez
- DAILY = A una misma hora LUN-VIE
- WEEKLY = Una vez a la semana a una misma hora

Ejemplo

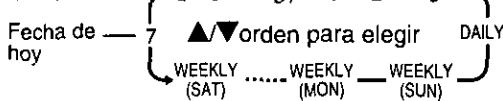

4 Oprimir ▲▼ y ◀▶ para elegir y fijar las siguientes fijaciones.

Fijaciones:

- Hora de inicio • Hora de parada
- Canal, DTV o LINEA para una fuente externa.
- Velocidad de la cinta (SP, LP, SLP).

Para hacer correcciones

Oprimir ▶ sucesivamente para avanzar o ◀ para retroceder hasta el paso que desea corregir.

5 Oprimir PROG para terminar la programación.

- Esta pantalla aparece para su confirmación.

Si usa un receptor DSS y fija un canal de 100-125, aparecerá la pantalla a la derecha.

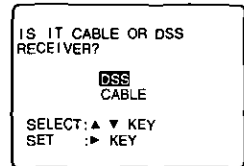
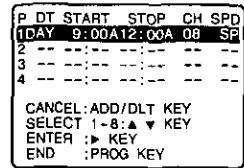

Oprimir ▲▼ para elegir "DSS" o "CABLE" y

luego oprimir ▶ para fijar.

- La pantalla para la confirmación como demuestra arriba aparecerá luego de la fijación.

Para hacer más programaciones

Oprimir ▲▼ y ▶ para elegir y fijar un número de programación en blanco y luego repita los pasos 3 y 4.

6 Oprimir PROG para salir desde este modo y volver a la pantalla normal.

7 Oprimir POWER y apague el aparato para la grabación con temporizador.



Pantalla multifuncional

- Si la fuente de la grabación es una caja de TV por cable, asegúrese de que la caja de TV por cable esté encendida y esté sintonizado al canal que desea grabar.
- Para la Grabación por Temporizador DTV deberá asegurarse de que la caja superior de ajuste se deja activada (ON) y ajustada al programa deseado, y de que el interruptor D-VHS está ajustado a HS o HS/STD.

Location of Controls

Remote Control Buttons

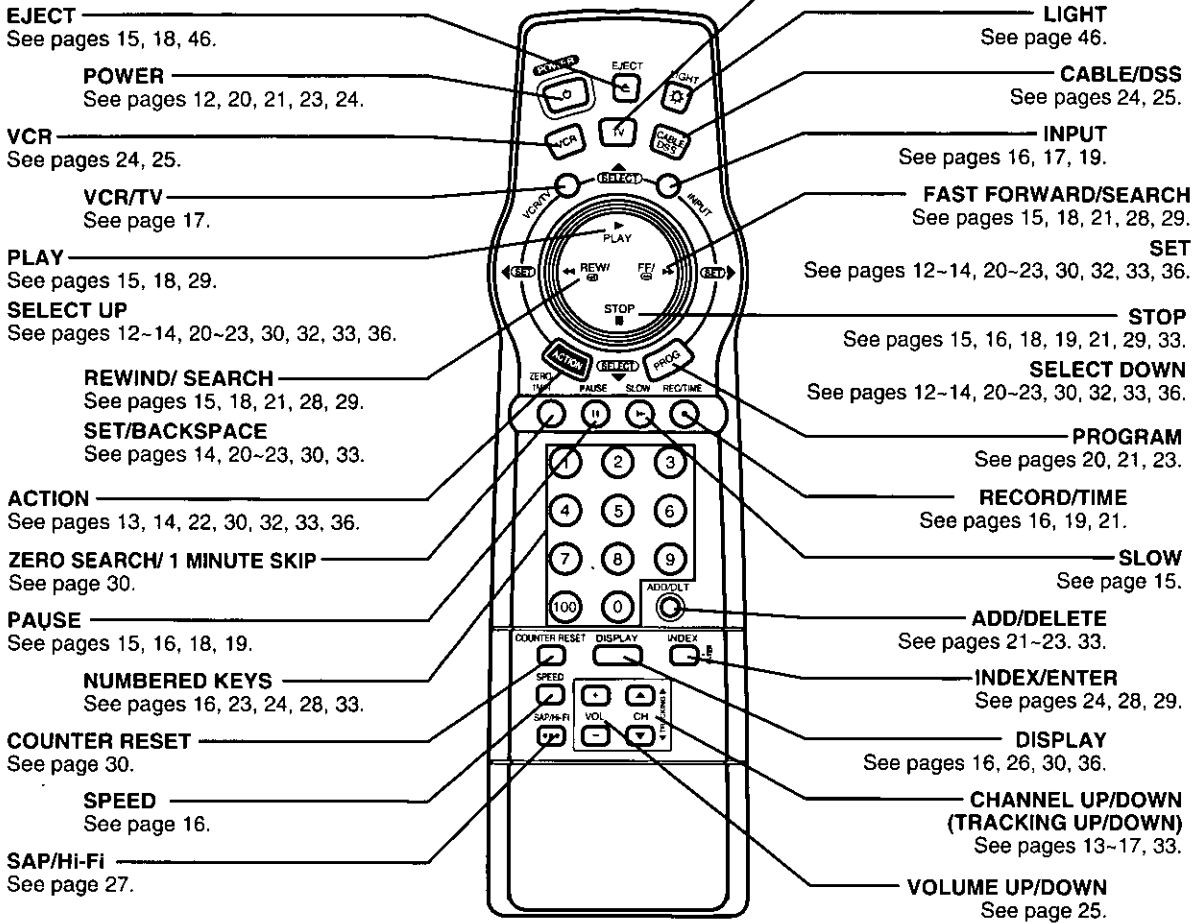

Light Tower® Universal Remote Control

Light button: When the LIGHT button is pressed, the buttons which can be activated in the selected mode will light and the selected mode button (TV/VCR or CABLE DSS) will flash for 5 seconds. If no buttons are pressed within 5 seconds, the light will turn off in order to conserve battery power. Also, while holding down the buttons, the selected mode button will flash so you will be able to see, in the dark, which mode has been selected.

EJECT button: When EJECT is pressed, the tape is ejected from Cassette Compartment. If EJECT is pressed during recording, the D-VHS VCR will not respond to the command.

Front View of the D-VHS VCR

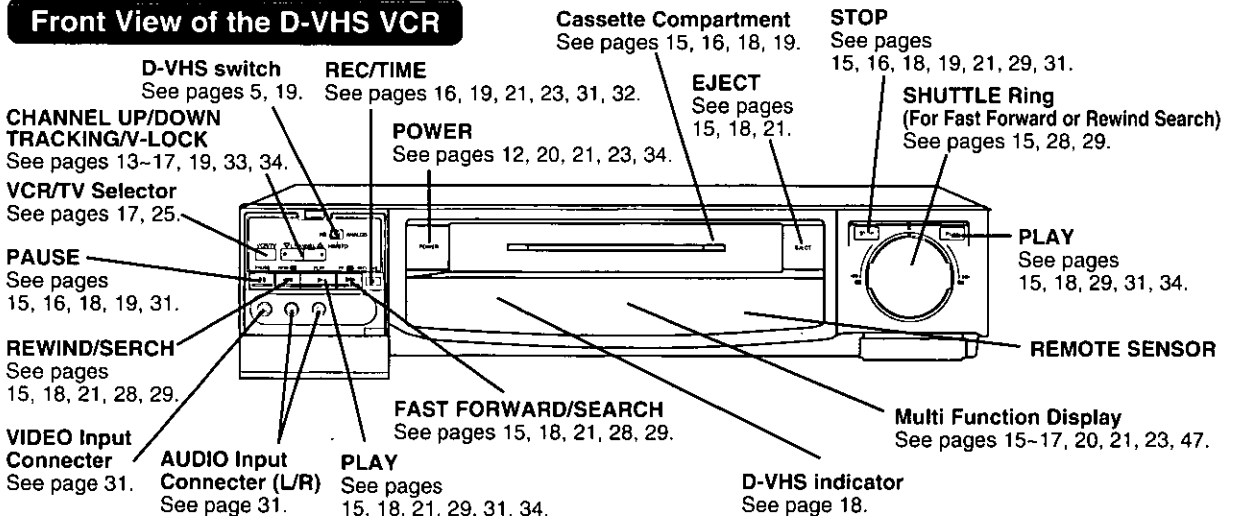

Multi Function Display

Timer Indicator

Lights when the D-VHS VCR is set for a Timer Recording, or when a length is set for a normal recording. The Timer Indicator flashes when a Timer Recording is set, but a tape has not been inserted into the D-VHS VCR.

REC(ord) Indicator
Lights during recording.

STEREO Indicator

Lights when the station you are tuned to is broadcasting stereo.

SAP Indicator

Lights when the station you are tuned to is broadcasting SAP.

Cassette-In Indicator
Lights when a tape is in the D-VHS VCR.

SPEED Display

Displays the recording speed.

REC Level Meter

Repeat Indicator

VCR Indicator

Lights when the VCR/TV selector is set to D-VHS VCR.

Hi-Fi Indicator

Lights when Hi-Fi audio is monitored or played back.

Function Indicator

Shows what the D-VHS VCR is doing.

REC and ▶	Record
REC and	Record-pause
▶	Playback
	Slow motion or Frame advance
	Play-pause
◀ Flashing	Rewind or Rewind search
▶ Flashing	Fast forward or Forward search
Flashing	Cassette ejecting

Display

- Displays the current time.
- Briefly displays D-VHS VCR status when a function button is pressed.
- Briefly displays the channel number, or "L" when a channel or line input is selected.
- Displays "d" when DTV is selected.
- Displays the tape counter during tape operation.
- Displays "HOLd" if an invalid key is pressed when the VCR lock is activated.
- Displays "HS" or "STd" mode for 5 seconds when SPEED is pressed during digital playback, or while a digital broadcast is received when HS or HS/STD of the D-VHS switch is selected.
- Displays "CP" (Copy Protection) when copy protected program is detected during digital playback or digital recording.
- Displays "ACT" when D-VHS VCR is in menu screen mode.
- Displays "PRG" when D-VHS VCR is in program screen mode.
- Displays "SnF" (Signal not Found) when digital signal is not received via IEEE1394 cable during digital recording (see page 37).

Rear View of the D-VHS VCR

Audio Output Connector (L/R)
See pages 6, 7, 26, 31.

Digital Interface
See pages 6, 7.

AC Power Plug

While plugged into an AC outlet, the D-VHS VCR consumes 8.9 W of electrical power in OFF condition.

VHF/UHF Antenna Input Terminal
See pages 6-8, 10, 26, 31.

VHF/UHF Antenna Output Terminal
See pages 6-8, 10, 26, 31.

Video Output Connector
See pages 6, 7, 26, 31.

Channel 3/4 Switch
See page 12.

Audio Input Connector (L/R)
See pages 6, 10, 31.

Video Input Connector
See pages 6, 10, 31.

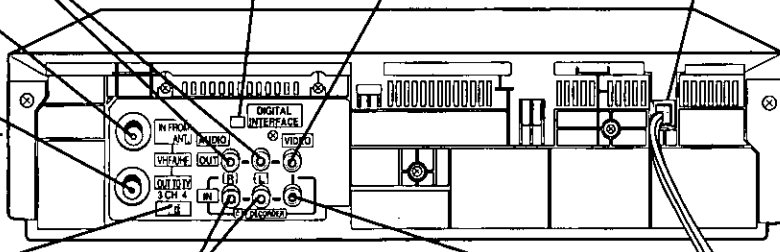

Quick Use Guide

VHS Playback

Turn TV on Select D-VHS VCR Channel 3/4



Insert a tape

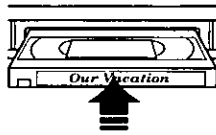

Start playback

STOP



Stop playback



Eject tape

VHS Recording

Turn TV on Select D-VHS VCR Channel 3/4

Insert a tape with Record Tab

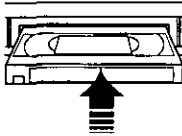

Select channel



Select speed

REC/TIME



Start recording

STOP



Stop recording

D-VHS Playback

Turn Set Top Box and Digital TV on



Insert a D-VHS tape

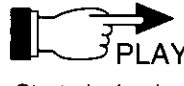
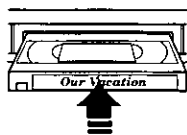

Start playback

STOP



Stop playback



Eject tape

D-VHS Recording

Turn Set Top Box on

Insert a D-VHS tape with Record Tab

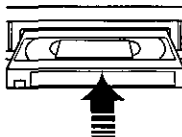

Select channel with the Set Top Box



Select "DTV"

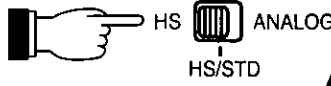

Slide to HS or HS/STD

REC/TIME



Start recording

STOP



Stop recording

Panasonic Consumer Electronics Company, Division of Matsushita Electric Corporation of America
One Panasonic Way Secaucus, New Jersey 07094

Panasonic Sales Company, Division of Matsushita Electric of Puerto Rico, Inc. ("PSC")
Ave. 65 de Infantería, Km. 9.5
San Gabriel Industrial Park, Carolina, Puerto Rico 00985