

Video Cassette Recorder  
**VRA641AT**

## Owner's Manual

**Important!**  
Return your Warranty Registration  
Card within 10 days. See why inside.



**VCR plus+**  
Easy Taping.

**PHILIPS MAGNAVOX**



---

### Welcome to your VCR owner's manual.

This manual has seven sections: Setting Up Your VCR; Description of Controls; Basic Operations; Recording; Playing; Additional Features; and Information You May Need. The instructions explain all of the VCR's features, which are listed below.

#### Features

- Automatic Channel Setup
- Automatic Clock Setting
- Automatic Head Cleaner
- Blue Background
- Child Lock
- Hi-Fi Stereo Tape Playback
- Index Search
- Multi-Channel Television Sound (MTS) System
- 19 Micron Head
- On-Screen Menus in English, Spanish, or French
- Quick Programming
- Remote Control with Capability to Operate TV, Cable Box, and Direct Broadcast System (DBS)
- Repeat Play
- Skip Search
- SmartPicture™
- VCR Plus+ Programming System
- Video Stabilizer

#### Safety Precautions

**Warning: To prevent fire or shock hazard, do not expose this equipment to rain or moisture.**

**Federal Communications Commission (FCC) Warning: Any unauthorized changes or modifications to this equipment void the user's authority to operate it.**

This VCR, equipped with a High Quality (HQ) System, is compatible with existing Video Home System (VHS) equipment. Philips Consumer Electronics recommends that you use only video cassette tapes that are labelled with the  mark. The use of other tapes may result in poor picture quality and excessive deposits on the video heads, which may not be covered by the warranty if damage occurs.

This VCR also is equipped with S-VHS Quasi Playback (SQPB), allowing you to play S-VHS recordings with regular VHS resolution. This product has a 19 micron head that provides a better picture when you view tapes recorded in slow speed (SLP).

Note to the Cable TV System Installer: This reminder is provided to call the Cable TV system installer's attention to Article 820-40 of the National Electrical Code, which provides guidelines for proper grounding – in particular, specifying that the cable ground shall be connected to the grounding system of the building, as close to the point of cable entry as possible.

Operation is subject to the following two conditions: (1) this device may not cause interference, and (2) this device must accept any interference, including interference that may cause undesired operation of the device.

Copyright 1999 Philips Consumer Electronics. All rights reserved. SmartPicture is a trademark of Philips Consumer Electronics. VCR Plus+ and PlusCode are registered trademarks of Gemstar Development Corporation. The VCR Plus+ system is manufactured under license from Gemstar Development Corporation.



The ENERGY STAR® name and logo are registered marks of the U.S. Environmental Protection Agency. As an ENERGY STAR® Partner, Philips Consumer Electronics has determined that this product meets the ENERGY STAR® guidelines for energy efficiency.

#### Helpful Hints

- *Your new product, its packaging, and this manual contain materials that can be recycled and reused. Specialized companies can recycle your product to increase the amount of reusable materials and to minimize the amount that needs to be properly disposed. Your product uses batteries that should not be thrown away when depleted but should be disposed of as small chemical waste. Please find out about the local regulations on disposal of your old products, batteries, manual, and packaging whenever you replace existing equipment.*

## 4 Table of Contents

---

### Setting Up Your VCR

Introduction	3
Table of Contents	4
Before Using Your VCR	5
Hookups without a Cable Box	6-7
Hookups with a Cable Box/Direct Broadcast System	8-9
Turning on Your VCR	10
Automatic Channel Setup	11-12
Setting the Clock	13-17
Daylight-Savings Time	18
Language Selection	19

### Description of Controls

Remote Control Buttons	20-21
Display Panel	22
Front Panel	23
Rear Panel	24
On-Screen Status Displays	25
Setting the Remote Control to Operate a TV	26
Setting the Remote Control to Operate a Cable Box/DBS	27

### Basic Operations

Playing	28
Recording	29

### Recording

One-Touch Recording	30
Recording One Channel/Watching Another	31
Setting Up the VCR Plus+ Programming System	32-33
Timer Recording with the VCR Plus+ Programming System	34-35
Quick Programming	36-39
Timer Recording Speed Setting	40
Rerecording (Tape Duplication)	41

### Playing

Index Search	42
Multi-Channel Television Sound System	43-44
Hi-Fi Stereo Tape Playback	45
Video Stabilizer	46
SmartPicture	47
Playback Options	48

### Additional Features

Child Lock	49
Blue Background	50
Automatic Operation Features	51

### Information You May Need

Glossary	52
Specifications	53
Helpful Hints	54-55
Limited Warranty	56
Index	57
Accessories	60

## Before Using Your VCR 5

### Removing the Plastic Cover from the Front Panel

A thin, plastic cover may protect the front panel of your VCR. Before using the VCR, lift a corner of the plastic, then peel it off.

### Putting Batteries in the Remote Control

1

To remove the battery compartment lid, push in the tab, then pull up the lid.

2

Place two AA batteries inside the battery compartment with their + and - ends aligned as indicated.

3

Replace the battery compartment lid.

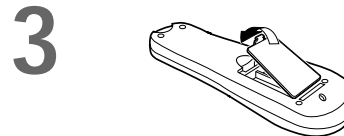
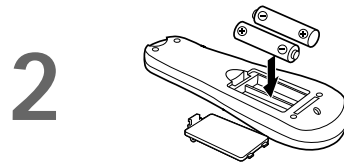
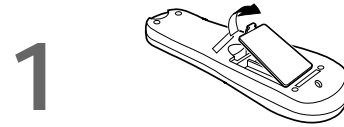

### Using the Remote Control

- Do not put objects between the remote control and the VCR.
- Point the remote control at the VCR's remote sensor, then press the VCR button before pressing other VCR operation buttons.
- Point the remote control at the TV, then press the TV button before pressing other TV operation buttons.
- Point the remote control at the Cable Box/DBS, then press the CBL/DBS button before pressing other Cable Box/DBS operation buttons.

### Erase Protection

Video cassettes have record tabs to ensure that recordings are not erased accidentally.

1

To prevent accidental erasure, break off the tab with a screwdriver.

2

To record again, cover the hole with cellophane tape.

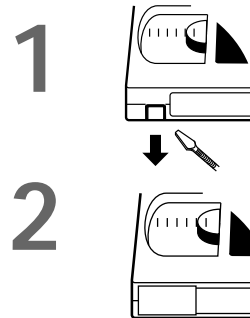

### VCR Maintenance

- Remove any light adhesive stick-on notes from the video cassette before putting the cassette in the VCR. Removable labels can jam the VCR.
- Periodic maintenance is required to maintain your VCR's performance. Your VCR has an automatic head cleaner, but the video heads eventually will require cleaning or replacement. Only an authorized service center should perform this service.

#### Helpful Hints

- The remote control and its batteries are supplied.
- Do not mix alkaline and manganese batteries.
- Do not mix old and new batteries.

## 6 Hookups without a Cable Box

The basic VCR/TV connection – antenna/cable to VCR to TV – is shown below. If you have a Cable Box or a Direct Broadcast System, please refer to pages 8-9. After you hook up the VCR, please go to page 10 to turn on the VCR.

# 1

Disconnect the antenna or cable from your TV.

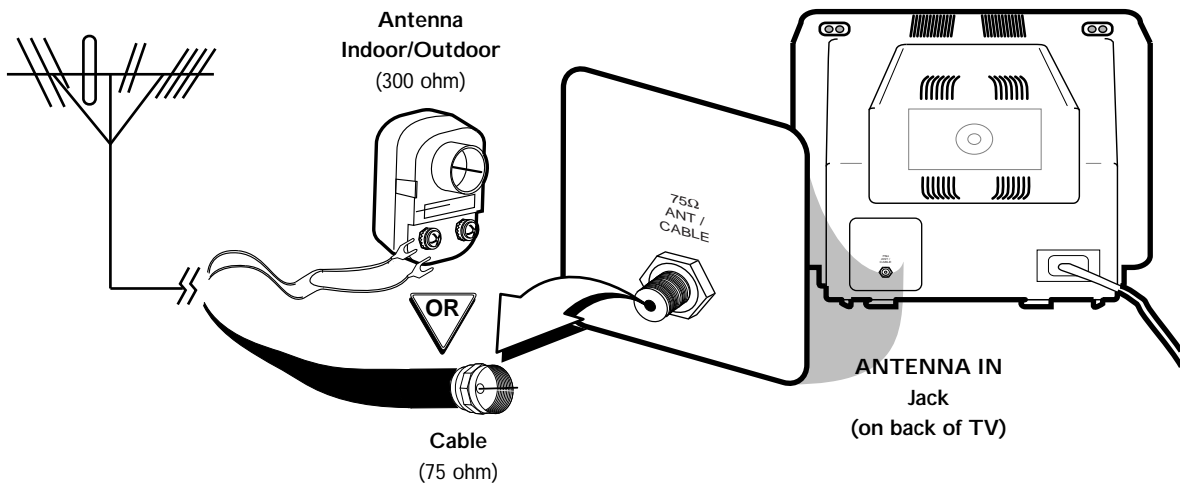

# 2

Connect the antenna or cable to the ANT(enna) IN Jack on the back of the VCR.

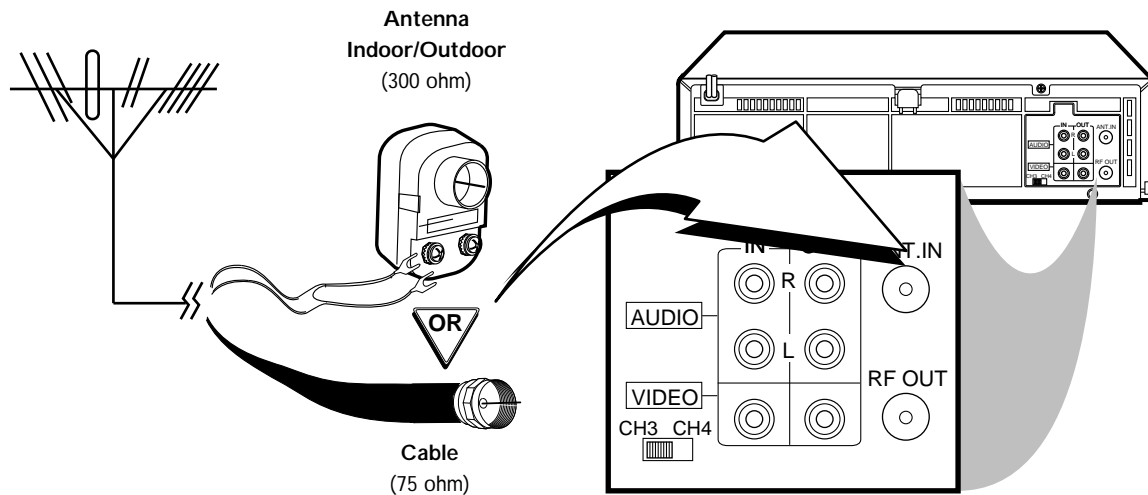

## Hookups without a Cable Box (cont'd) 7

### 3

Connect the RF coaxial cable (supplied) to the RF OUT Jack on the back of the VCR and to the ANTENNA IN Jack on the TV. (You may use either a snap-on type or screw-on type of coaxial cable, whichever you prefer. A snap-on type is supplied.)

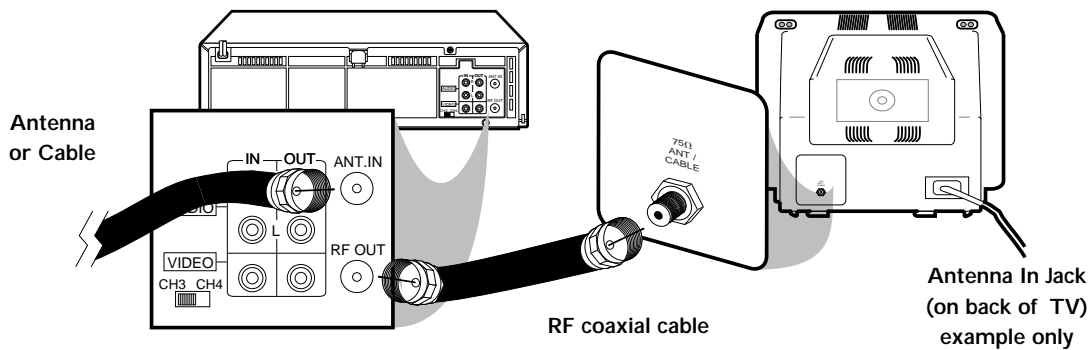

### 4

Plug in the TV and the VCR.

### 5

Set the CH3/CH4 switch on the back of the VCR to CH3 or CH4, whichever channel is not used or least used in your area. To operate your VCR with your TV, **set the TV to the same channel**. For example, when playing a tape, if the CH3/CH4 switch is set to CH3, the TV should be on channel 3.

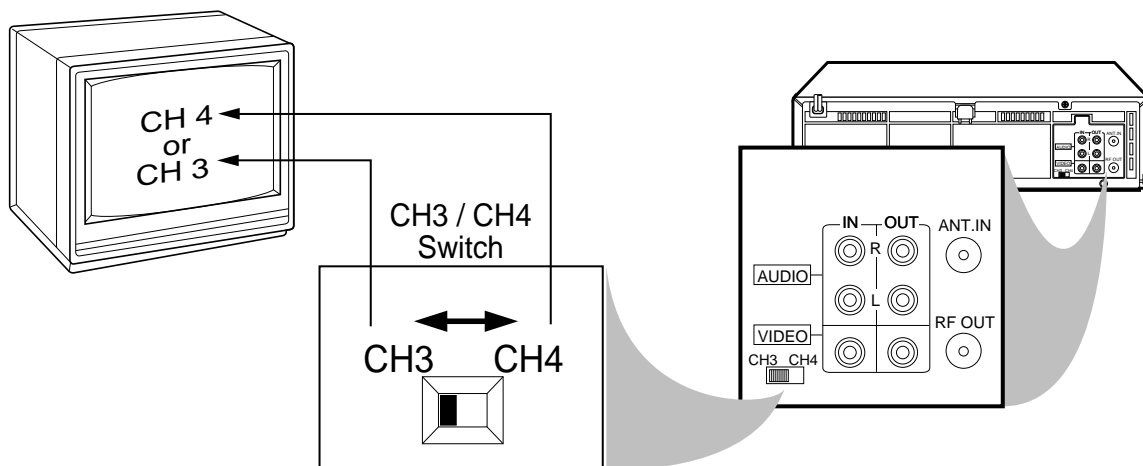

### 6

You are ready to turn on the VCR. Please go to page 10 before turning on the VCR.

## 8 Hookups with a Cable Box/Direct Broadcast System

---

There are two ways to connect your Cable Box/DBS to the VCR. With this connection:

- You may view any channel.
- You must select channels at the Cable Box/DBS. Channels cannot be changed at the VCR.
- You may not view a channel other than the one you are recording.
- You may not set up channels at the VCR.
- You can only program a timer recording for one channel at a time. Set the TV and the VCR to the Cable Box/DBS output channel (channel 03 or 04); set the CH3/CH4 switch to the same channel. Set your Cable Box/DBS to the channel you want to record. When you enter the channel you want to record in a timer recording, select channel 03 or 04 (the Cable Box/DBS output channel). (This is step 3 on page 36.) Leave the Cable Box/DBS on for a timer recording.

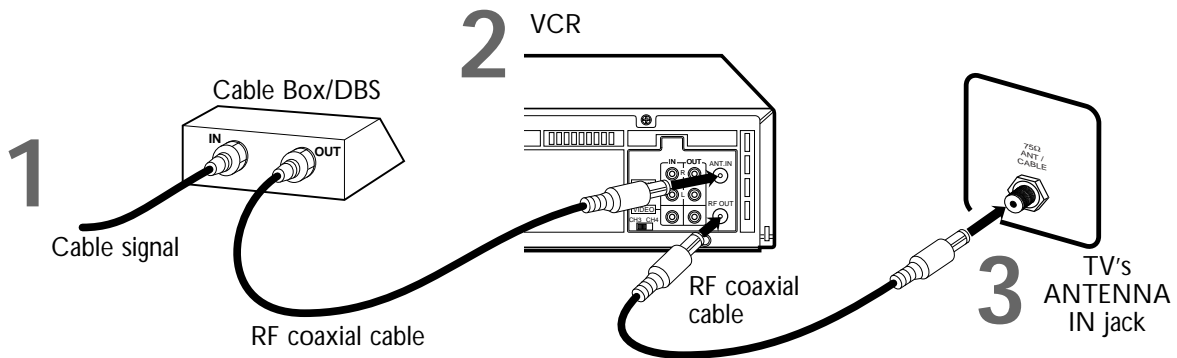

### Connections

1

Connect a Cable signal to the IN jack on the Cable Box/DBS.

2

Use an RF coaxial cable (supplied) to connect the OUT jack on the Cable Box/DBS to the ANT(enna) IN jack on the VCR.

3

Use a second RF coaxial cable to connect the RF OUT jack on the VCR to the TV's ANTENNA IN jack.

### Recording/Viewing Any Channel

1

With the VCR on and in VCR position (the VCR light will appear on the display panel), use the CH(annel) ▲/▼ button to set the VCR to the Cable Box/DBS output channel (channel 03 or 04).

2

Set the TV to the same channel to which you set the VCR. Set the CH3/CH4 switch on the VCR to the same channel.

3

Select the channel you want to view/record at the Cable Box/DBS.



## Hookups with a Cable Box/Direct Broadcast System (cont'd) 9

### With this connection:

- You may watch one channel while recording another.
- You may not record scrambled channels.

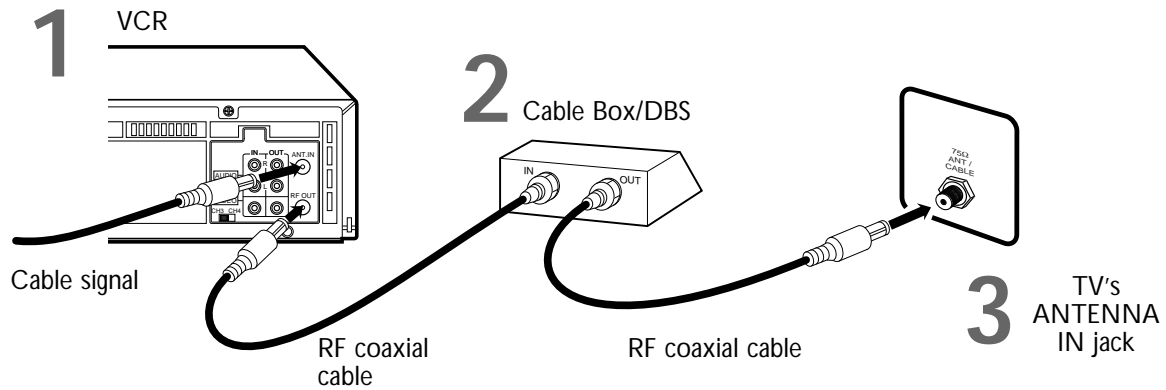

### Connections

1

Connect a Cable signal to the VCR's ANT(enna) IN jack.

2

Use an RF coaxial cable (supplied) to connect the RF OUT jack on the VCR to the IN jack on the Cable Box/DBS.

3

Use a second RF coaxial cable to connect the OUT jack on the Cable Box/DBS to the TV's ANTENNA IN jack.

### Recording One Channel/Watching Another

1

Put the Cable Box/DBS on the same channel as the VCR's CH3/CH4 switch. Set the TV to the Cable Box/DBS output channel (03 or 04).

Then, with the VCR in VCR position (the VCR light will appear on the display panel), use the CH(annel) ▲/▼ button to select the channel you want to record at the VCR. Start the recording.

2

Press the VCR/TV button once to put the VCR in TV position. (The VCR light will disappear.)

3

Select the channel you want to watch at the Cable Box/DBS.

#### Helpful Hint

- When you play a tape, make sure the Cable Box/DBS is set to the same channel as the CH3/CH4 switch on the VCR. Set the TV to the Cable Box/DBS output channel (03 or 04).

## 10 Turning on Your VCR

Before turning on your VCR, make sure batteries are in the remote control and the VCR, TV, and Cable Box/DBS (if applicable) are connected.

# 1

Press the **VCR** button, then press the **POWER** button.

# 2

Turn on the TV. Set it to channel 3 or 4, whichever channel the **CH3/CH4** switch on the back of the VCR is set to. The menu shown below will appear.

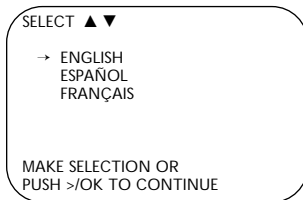

# 3

Press the **PLAY ▲** or **STOP ▼** button to select the language of the on-screen displays and menus.

# 4

Press the **FF ►/OK** button. The menu shown below will appear.

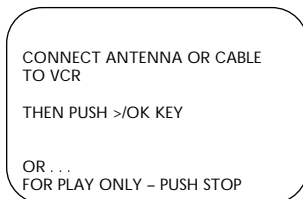

# 5

Press the **FF ►/OK** button to begin automatic channel setup. **AUTO CH. SET PROCEEDING PLEASE WAIT** will appear on the screen. The VCR will memorize all of the channels you receive, so when you scan through channels using the **CH(annel) ▲/▼** button, you'll only scan through channels that you receive.

# 6

When channels are set up, **AUTO CH. SET COMPLETED** will appear on the screen briefly.

# 2

Turn on the TV.

# 6

Wait for the VCR to set up channels.

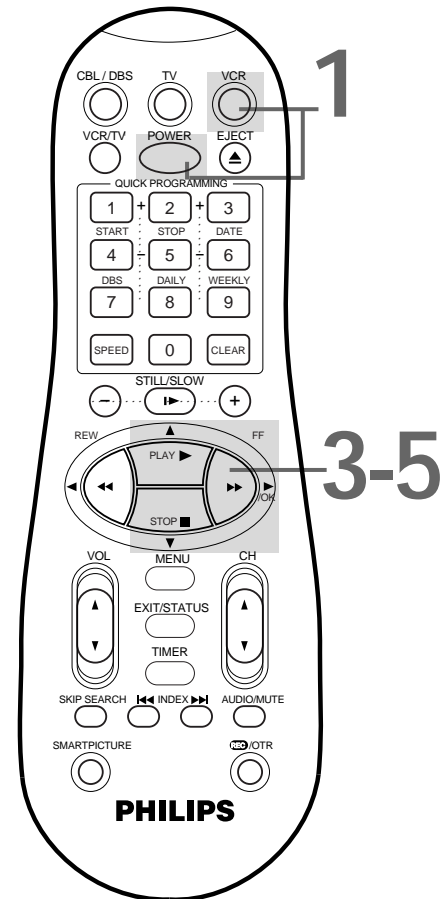

### Helpful Hints

- Auto or -- : -- may appear on the display panel until the clock is set.
- If you do not want to set up channels now, press the **STOP ▼** button at step 5. **TUNER NOT SET** will appear on the screen briefly.
- You may not set up channels at step 5 if you are using a Cable Box/DBS.

# Automatic Channel Setup 11

Although your VCR may automatically memorize the channels you receive when you turn it on for the first time, this function lets you set up channels again. Make each entry within one minute of the previous entry.

# 1

Press the VCR button, then press the MENU button.

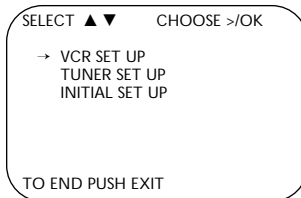

# 2

Press the PLAY ▲ or STOP ▼ button to select TUNER SET UP, then press the FF ►/OK button.

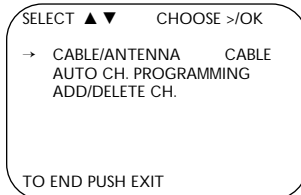

# 3

Press the FF ►/OK button repeatedly so that ANT (if you have an antenna) or CABLE (if you have a cable connection) appears beside CABLE/AUTOMATIC.

# 4

Press the STOP ▼ button to select AUTO CH. PROGRAMMING, then press the FF ►/OK button. AUTO CH. SET PROCEEDING PLEASE WAIT and a scale that shows the progress of channel setup will appear on the screen. The VCR will memorize all the channels you receive.

# 5

Wait for a few minutes while the VCR sets up channels. When programming is complete, AUTO CH. SET COMPLETED will appear on the screen. Then, the programming of the lowest channel number placed in the VCR's memory will appear on the screen. Now when you press the CH(annel) ▲/▼ button, you will scan only through channels you receive.

**5** Wait for the VCR to set up channels.

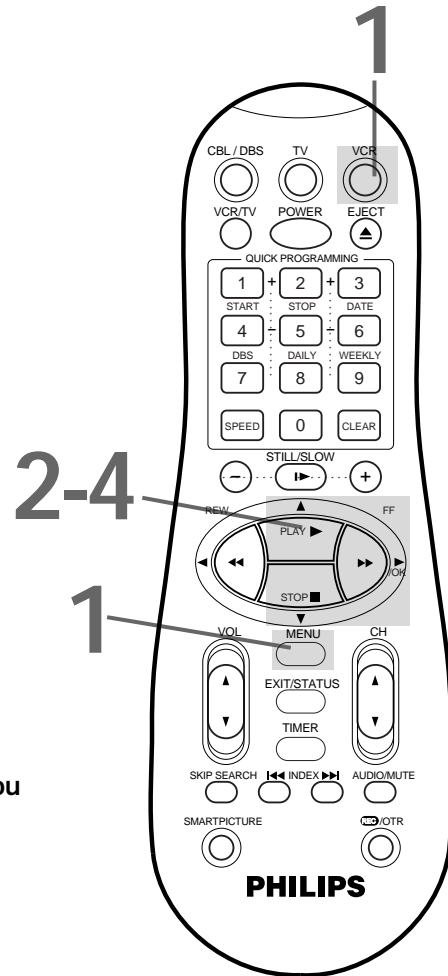

## Helpful Hint

- The two Line Input modes will always be stored in the VCR's memory at channel 00. To select A/V IN FRONT or A/V IN REAR, press 0,0, then press the CH(annel) ▲/▼ button so that A/V IN FRONT or A/V IN REAR appears on the screen briefly. To exit Line Input mode, use the CH(annel) ▲/▼ button to select a channel other than 00.

## 12 Automatic Channel Setup (cont'd)

### Adding/Deleting Channels

# 1

Press the VCR button, then press the MENU button.

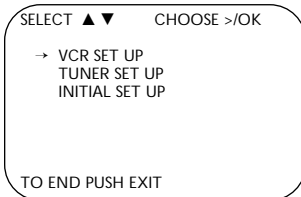

# 2

Press the PLAY ▲ or STOP ▼ button to select TUNER SET UP, then press the FF ►/OK button.

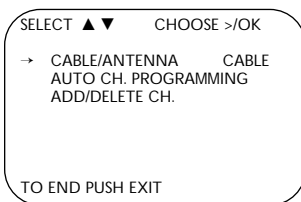

# 3

Press the PLAY ▲ or STOP ▼ button to select ADD/DELETE CH., then press the FF ►/OK button.

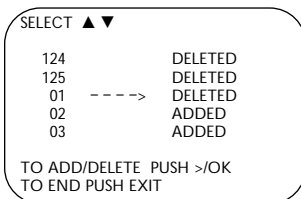

# 4

Use the Number buttons, the CH (annel) ▲/▼ button, or the PLAY ▲ or STOP ▼ buttons to select the channel you want to add or delete. An arrow will appear beside the selected channel.

# 5

Press the FF ►/OK button so that DELETED or ADDED appears beside the channel number.

# 6

Press the EXIT/STATUS button. Programming of the last channel you added or deleted will appear on the screen.

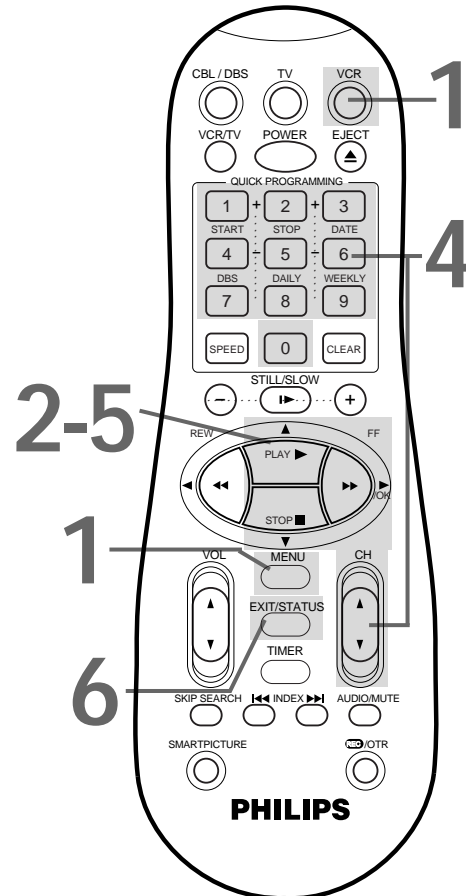

# Setting the Clock 13

There are four ways to set the VCR's clock: Manually, with Time Zone Selection, with Manual PBS Channel Selection, or with Automatic PBS Channel Selection. Cable Box/DBS users must set the clock manually. Before you set the clock, make sure:

- The VCR power is on.
- The VCR light appears on the display panel. If it does not, press the VCR/TV button once.
- Channels are set up.
- You make each entry within one minute of the previous entry.

To set the clock manually, follow the steps on pages 13-14. To use Time Zone Selection, go to page 15. To use Manual PBS Channel Selection, go to page 16. To use Automatic PBS Channel Selection, go to page 17.

## Manual Clock Setting

# 1

Press the **VCR** button, then press the **MENU** button.

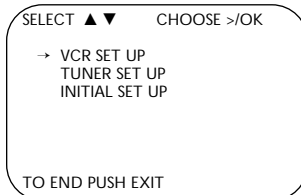

# 2

Press the **PLAY ▲** or **STOP ▼** button to select **INITIAL SET UP**, then press the **FF ►/OK** button.

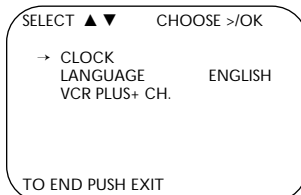

# 3

Press the **PLAY ▲** or **STOP ▼** button to select **CLOCK**, then press the **FF ►/OK** button.

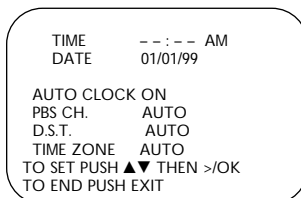

Instructions continue on page 14.

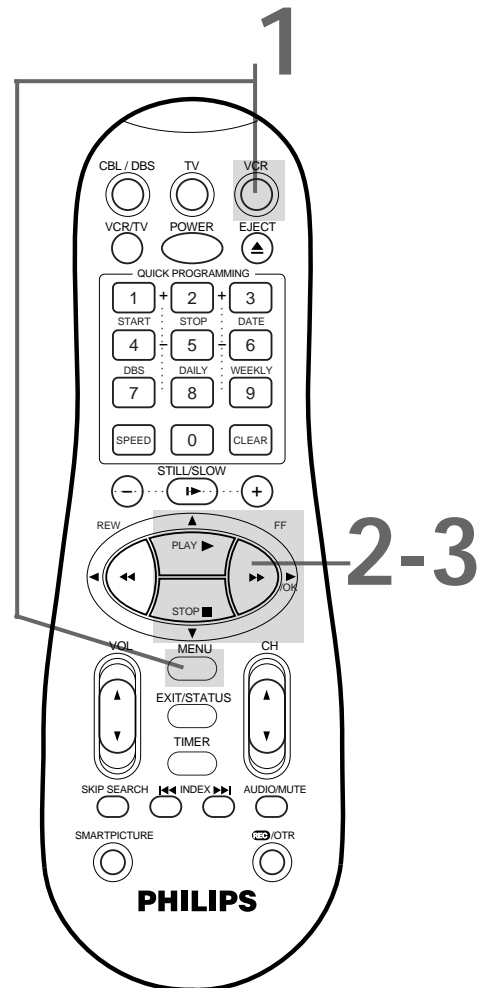

### Helpful Hints

- To program the VCR so its clock will automatically move forward one hour in April and turn back one hour in October, see page 18.
- To make corrections, follow steps 1-3, then press the **FF ►/OK** button until the item you want to correct is flashing. Press the **PLAY ▲** or **STOP ▼** button to enter the correct information. Press the **EXIT/STATUS** button.

## 14 Setting the Clock (cont'd)

# 4

Press the **PLAY ▲** or **STOP ▼** button repeatedly to set the **TIME**. Every time you press the **PLAY ▲** or **STOP ▼** button, the time changes in one-minute increments. If you press and hold the **PLAY ▲** or **STOP ▼** button, the time changes in 30-minute increments.

When the time is correct, press the **FF ►/OK** button.

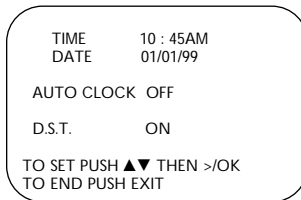

# 5

Press the **PLAY ▲** or **STOP ▼** button repeatedly to set the **DATE (month and day)**. Every time you press the **PLAY ▲** or **STOP ▼** button, the day changes in one-day increments. If you press and hold the **PLAY ▲** or **STOP ▼** button, the day changes in 15-day increments.

When the month and day are correct, press the **FF ►/OK** button.

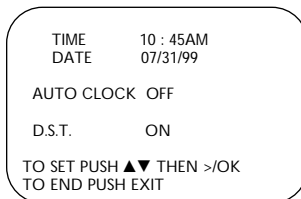

# 6

Press the **PLAY ▲** or **STOP ▼** button repeatedly to set the **YEAR**. When the year is correct, press the **FF ►/OK** button. The day of the week will appear automatically.

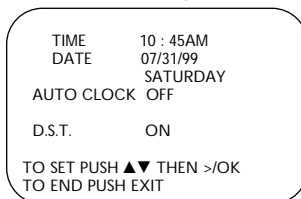

# 7

Press the **FF ►/OK** button once again to skip "AUTO CLOCK" and go to "D.S.T." (Daylight Savings Time). Press the **PLAY ▲** or **STOP ▼** button to set D.S.T. to **ON** or **OFF**. If AUTO CLOCK is OFF, you may set D.S.T. to ON or OFF only. For more information, please see page 18.

# 8

Press the **EXIT/STATUS** button.

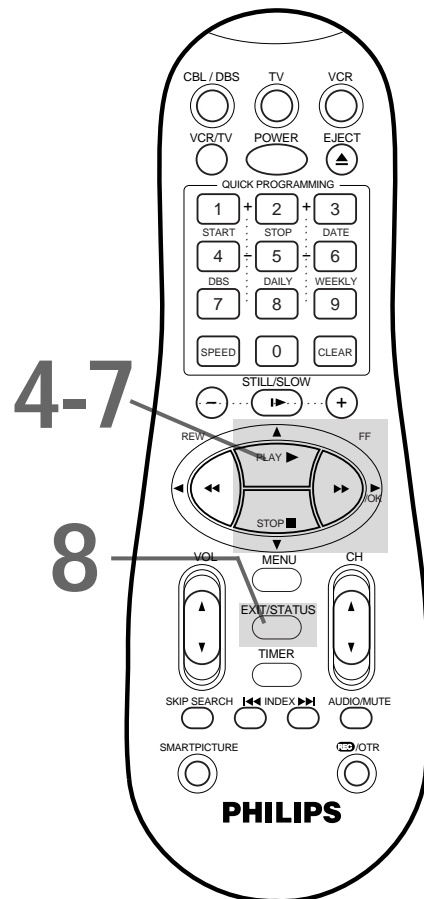

## Time Zone Selection

# 1

Press the VCR button, then press the MENU button.

# 2

Press the PLAY ▲ or STOP ▼ button to select INITIAL SET UP, then press the FF ►/OK button.

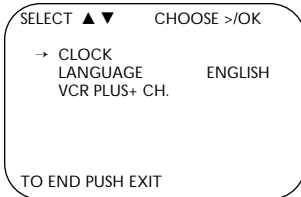

# 3

Press the PLAY ▲ or STOP ▼ button to select CLOCK, then press the FF ►/OK button.  
(If AUTO CLOCK is set to OFF, TIME ZONE will not be available in the menu. If this happens, press the FF ►/OK button to select AUTO CLOCK, then press the PLAY ▲ or STOP ▼ button to set AUTO CLOCK to ON.)

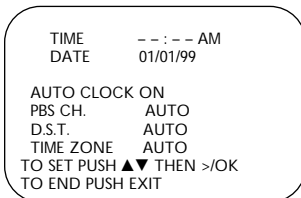

# 4

Press the FF ►/OK button repeatedly to select TIME ZONE.

# 5

Press the PLAY ▲ or STOP ▼ button repeatedly to select your Time Zone, then press the FF ►/OK button.

# 6

Press the EXIT/STATUS button.

# 7

An on-screen message will ask you to turn off the VCR. Press the POWER button to turn off the VCR. Auto will flash in the display panel until the clock is set. Leave the VCR turned off until the time appears on the display panel. If -- : -- appears on the display panel after you turn off the VCR, the VCR could not find the time. Use a different method to set the clock.

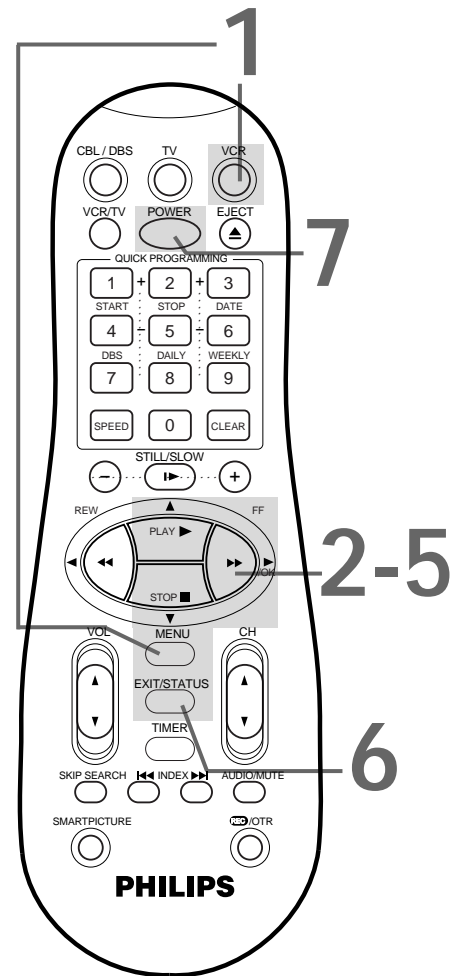

### Helpful Hints

- When the power plug is connected to an AC outlet, the correct time will appear on the display panel of the VCR when the power is off.
- Press the EXIT/STATUS button repeatedly to make the time appear on the display panel when the VCR power is on.

## 16 Setting the Clock (cont'd)

### Manual PBS Channel Selection

1

Press the VCR button, then press the MENU button.

2

Press the PLAY ▲ or STOP ▼ button to select INITIAL SET UP, then press the FF ►/OK button.

3

Press the PLAY ▲ or STOP ▼ button to select CLOCK, then press the FF ►/OK button. (If AUTO CLOCK is set to OFF, PBS CH. will not be available in the menu. If this happens, press the FF ►/OK button to select AUTO CLOCK, then press the PLAY ▲ or STOP ▼ button to set AUTO CLOCK to ON.)

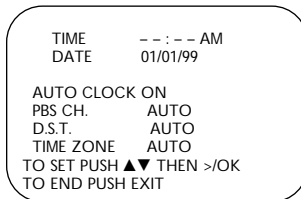

4

Press the FF ►/OK button to select PBS CH.

5

Press the PLAY ▲ or STOP ▼ button repeatedly to select the station number of your PBS channel.

6

Press the EXIT/STATUS button.

7

An on-screen message will ask you to turn off the VCR.

Press the POWER button to turn off the VCR.

Auto will flash in the display panel until the clock is set. Leave the VCR power off until the clock is set.

If --:-- appears on the display panel after you turn off the VCR, the VCR could not find the time. Repeat steps 1 - 6 above, entering a different PBS channel at step 5. Or, use a different method to set the clock.

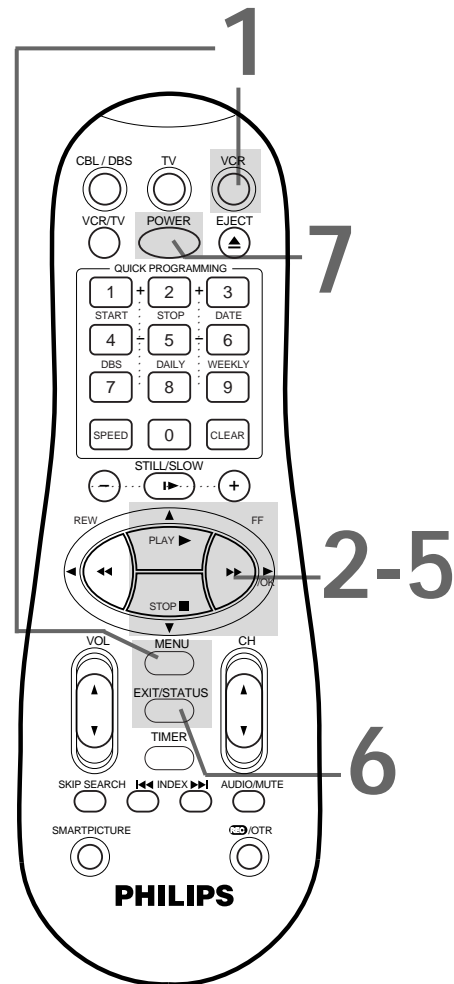



## Automatic PBS Channel Selection

1

Press the VCR button, then press the MENU button.

2

Press the PLAY ▲ or STOP ▼ button to select INITIAL SET UP, then press the FF ►/OK button.

3

Press the PLAY ▲ or STOP ▼ button to select CLOCK, then press the FF ►/OK button. (If AUTO CLOCK is set to OFF, PBS CH. will not be available in the menu. If this happens, press the FF ►/OK button to select AUTO CLOCK, then press the PLAY ▲ or STOP ▼ button to set AUTO CLOCK to ON.)

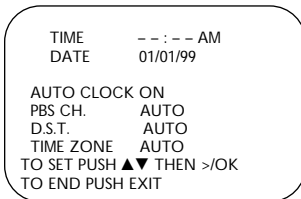

4

Press the FF ►/OK button repeatedly to select PBS CH.

5

Press the PLAY ▲ or STOP ▼ button repeatedly so that AUTO flashes beside PBS CH.

6

Press the EXIT/STATUS button.

7

An on-screen message will ask you to turn off the VCR.

Press the POWER button to turn off the VCR.

Auto will flash in the display panel until the clock is set. Leave the VCR power off until the clock is set. If ---:-- appears on the display panel after you turn off the VCR, the VCR could not find the time. Use a different method to set the clock.

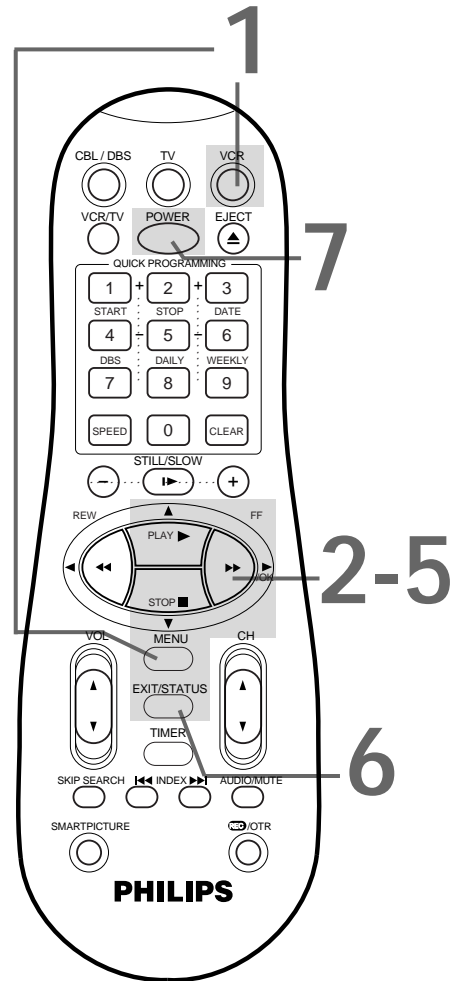

### Helpful Hints

- To display the time on the display panel, press the EXIT/STATUS button repeatedly.
- If you live near the boundary of an adjacent time zone, your PBS channel may come from a different time zone. Use Time Zone Selection to set your clock. Details are on page 15.

## 18 Daylight-Savings Time

Follow the steps below to program the VCR so its clock will automatically move forward one hour in April and turn back one hour in October.

# 1

Press the **VCR** button, then press the **MENU** button.

# 2

Press the **PLAY** ▲ or **STOP** ▼ button to select **INITIAL SET UP**, then press the **FF** ►/OK button.

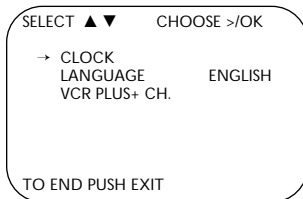

# 3

Press the **PLAY** ▲ or **STOP** ▼ button to select **CLOCK**, then press the **FF** ►/OK button. (If **AUTO CLOCK** is set to **OFF**, **PBS CH.** and **TIME ZONE** will not appear in the menu.)

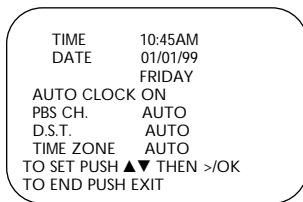

# 4

Press the **FF** ►/OK button repeatedly to select **D.S.T.**

# 5

Press the **PLAY** ▲ or **STOP** ▼ button so that **ON**, **OFF**, or **AUTO** appears beside **D.S.T.**

Select **ON** to make the clock adjust itself according to the VCR's calendar. Select **OFF** to turn off the feature. Select **AUTO** to make the clock adjust itself according to the signal it receives from the PBS channel. If **AUTO CLOCK** is set to **OFF**, you may only set **D.S.T.** to **ON** or **OFF**.

# 6

Press the **EXIT/STATUS** button.

# 7

An on-screen message may ask you to turn off the VCR. Press the **POWER** button to turn off the VCR. Auto will flash in the display panel until the clock is set. Leave the VCR power off until the clock is set. If -- : -- appears on the display panel after you turn off the VCR, the VCR could not find the time. Use a different method to set the clock.

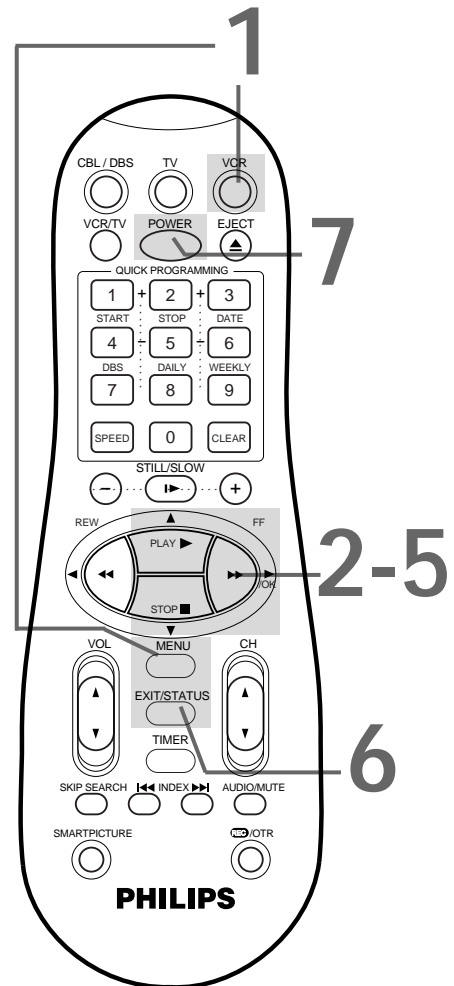

# Language Selection 19

Follow the steps below to change the language of the on-screen displays and menus.

## 1

Press the VCR button, then press the MENU button.

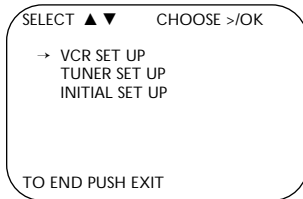

## 2

Press the PLAY ▲ or STOP ▼ button to select INITIAL SET UP, then press the FF ►/OK button.

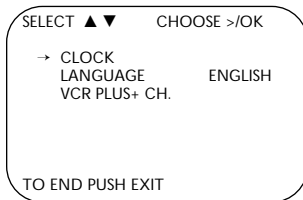

## 3

Press the STOP ▼ button or PLAY ▲ button to select LANGUAGE.

## 4

Press the FF ►/OK button repeatedly until your preferred language appears.

## 5

Press the EXIT/STATUS button.

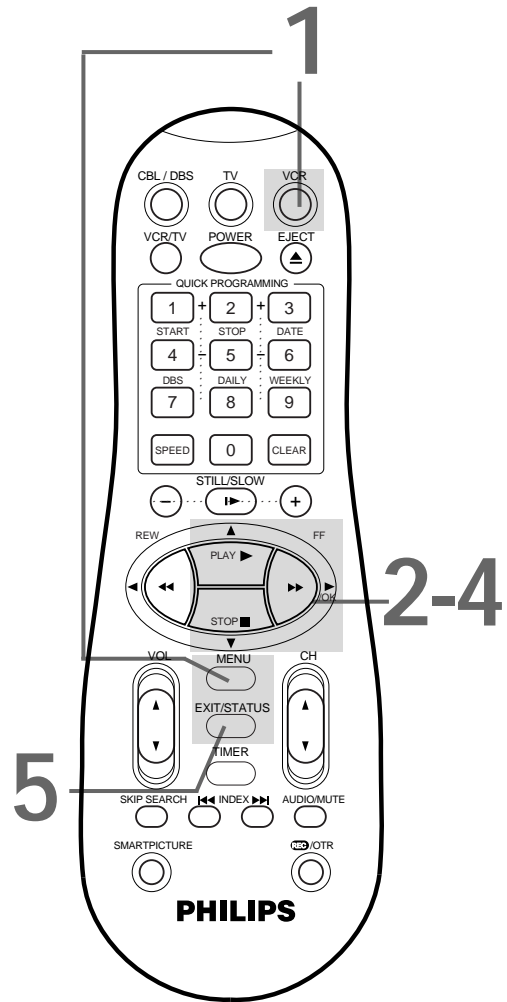

### Helpful Hint

- If you accidentally select Spanish or French and need English, follow these steps.
  - 1) Press the VCR button, then press the MENU button.
  - 2) Press the PLAY ▲ or STOP ▼ button to select SISTEMA INICIAL or PROGRAMM. INITIALE, then press the FF ►/OK button.
  - 3) Press the PLAY ▲ or STOP ▼ button to select LENGUAJE or LANGUE.
  - 4) Press the FF ►/OK button repeatedly so that the English menu appears.
  - 5) Press the EXIT/STATUS button.

## 20 Remote Control Buttons

### TV Button

Press this button before pressing other TV operation buttons.

### CBL/DBS Button

Press this button before pressing Cable Box/DBS operation buttons.

### PLAY ▲ Button

When operating the VCR, press to play a tape. Also, press to release Slow, Still, or Search mode and to return to normal playback. *Details are on page 48.* Press to select an item in the VCR menu.

*For some PHILIPS or PHILIPS MAGNAVOX TVs only:*

After pressing the TV button, press this button to select an item in the TV menu.

### REW(ind)◀ Button

When tape playback is stopped, press to rewind the tape at high speed. During tape playback, press to rewind the tape while the picture stays on the screen. *Details are on page 48.* When operating the VCR, press to return to a previous menu.

*For some PHILIPS or PHILIPS MAGNAVOX TVs only:*

After pressing the TV button, press this button to adjust an item in the TV menu.

### VOL(ume) ▲/▼ Button

Press to increase or decrease the TV's volume.

### MENU Button

Press to access the main VCR menu. Press again to remove the menu.

*For some PHILIPS or PHILIPS MAGNAVOX TVs only:*

After pressing the TV button, press this button to access the TV menu.

### REC(ord)/OTR Button

Press once to start a recording. *Details are on page 29.* Or, press repeatedly to start a One-Touch Recording. *Details are on page 30.*

### VCR Button

Press this button before pressing VCR operation buttons.

### POWER Button

After pressing the CBL/DBS, VCR, or TV button, press to turn on or off the Cable Box/DBS, VCR, or TV.

### EJECT Button

Press to eject the tape.

### Number Buttons

After pressing the CBL/DBS, TV, or VCR button, press to select a channel at the Cable Box/DBS, TV, or VCR.

### CLEAR Button

Press to reset the real-time counter to zero.

### FF ▶/OK Button

When tape playback is stopped, press to advance the tape at high speed. During tape playback, press to advance the tape while the picture stays on the screen. *Details are on page 48.* When operating the VCR, press to go to the next VCR menu.

*For some PHILIPS or PHILIPS MAGNAVOX TVs only:*

After pressing the TV button, press this button to adjust an item in the TV menu.

### STOP ▼ Button

Press to stop the tape. When operating the VCR, press to select an item in the menu.

*For some PHILIPS or PHILIPS MAGNAVOX TVs only:*

After pressing the TV button, press this button to select an item in the TV menu.

### CH(annel) ▲/▼ Button

After pressing the CBL/DBS, TV, or VCR button, press to scan through the channels of the Cable Box/DBS, TV, or VCR.

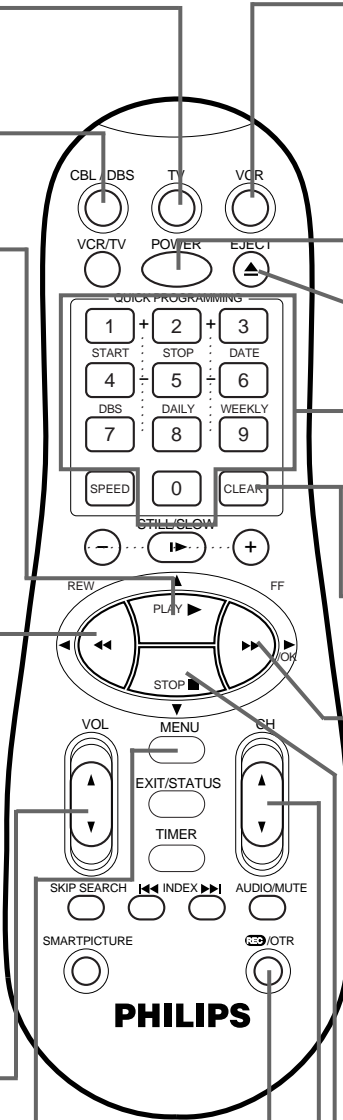

## Remote Control Buttons (cont'd) 21

### VCR/TV Button

After pressing the VCR button, press this button to select the signal that your TV receives.

- VCR Position

Use to watch a tape, to watch a program while recording it, or to watch a TV broadcast using the CH(annel) ▲/▼ or Number buttons to change channels at the VCR. The VCR light will appear on the display panel when the VCR is in VCR position.

- TV Position

Use to watch TV (selecting channels at the TV) or to watch one program while recording another. *Details are on page 31.* The VCR light will not appear when the VCR is in TV position.

After pressing the TV button, press this button to select TV mode or Auxiliary mode at the TV.

### SPEED Button

Press to select the recording speed (SP or SLP). *Details are on pages 37 and 52.*

### EXIT/STATUS Button

Press to exit the on-screen menus. Press to bring up the status display for five seconds. *Details are on page 25.* When tape playback is stopped, press repeatedly to see the real-time counter, the current channel, or the current time on the display panel. During tape playback, press repeatedly to see the current time or the real-time counter on the display panel.

*For some PHILIPS and PHILIPS MAGNAVOX TVs only:*

Press the TV button, then press this button to access the TV on-screen displays or to exit the TV menu.

*For other manufacturers' TVs or Cable Box/DBS:*

After pressing the TV or CBL/DBS button, the EXIT/STATUS button will function as an ENTER button at the TV or Cable Box/DBS.

### STILL/SLOW Buttons

While recording, press STILL/SLOW ► to temporarily stop the recording. Press a second time to resume normal recording. *Details are on page 29.* During tape playback, press STILL/SLOW ► once to freeze the picture. Press repeatedly to advance the Still picture frame by frame. *Details are on page 48.*

During tape playback, press and hold for more than three seconds to play the tape in slow motion. *Details are on page 48.*

### TIMER Button

Press to access the timer recording menu. *Details are on pages 34-39.*

### INDEX Buttons

When tape playback is stopped, press to search for index codes recorded on the tape. *Details are on page 42.*

### AUDIO/MUTE Button

Press the TV button, then press the AUDIO/MUTE button to eliminate the TV's sound. Press again to restore the sound. Or, press the VCR button, then press the AUDIO/MUTE button to select MONO or HI-FI. *Details are on pages 43-45.*

### SKIP SEARCH Button

Press during tape playback to fast forward 30 seconds of a tape. This feature will only work with tape segments recorded in SP or SLP speed.

### SMARTPICTURE Button

Press to select the SmartPicture mode. *Details are on page 47.*

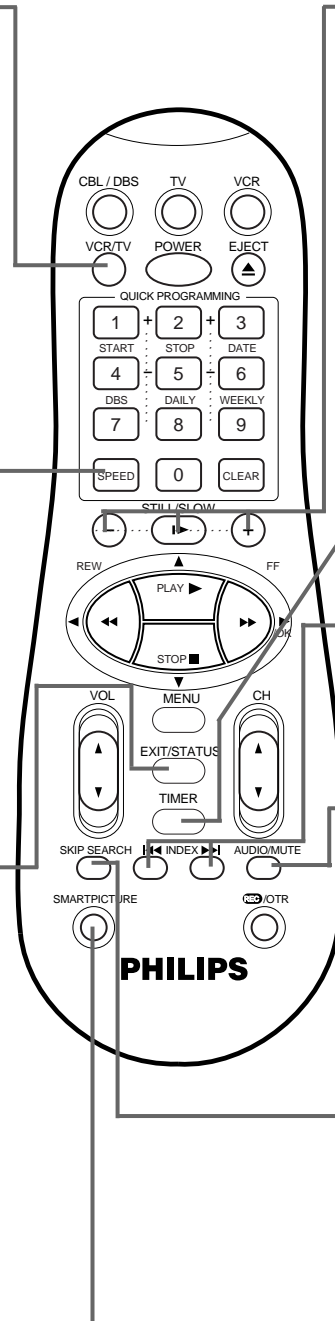

### Helpful Hint

- This remote control may or may not operate your TV or Cable Box/DBS. Or, it may only work some features of this equipment. See pages 26-27 for details.

## 22 Display Panel

### VCR Display Panel

Information about VCR operations appears here. Different information appears at different times. The display is brighter when the VCR power is on. The display dims automatically when you turn off the VCR power.

### Remote Sensor

Receives a signal from your remote control so you can operate your VCR from a distance. Press the VCR button on the remote control before pressing other VCR operation buttons.

### Cassette Compartment

Insert a tape here.

### TIMER Light

This light appears when a timer recording is programmed or is in progress. *Details are on pages 34-39.* This light blinks rapidly if the VCR is turned off to set a Timer Recording but a tape is not in the VCR. The light also may flash if a Timer Recording is set but the clock is not set.

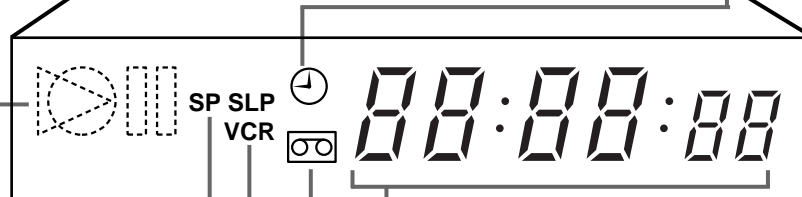
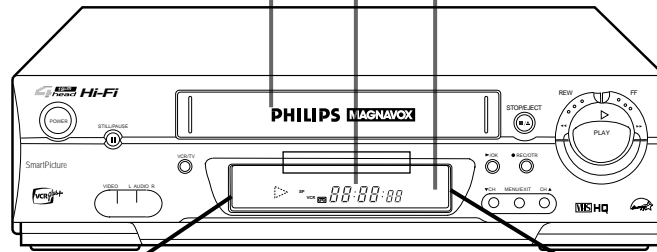

### Operation indicators

These indicators tell you the current operation of the VCR.

- ▷: Play, Forward and Reverse Searching
- : Record
- |○: Record Pause
- ▷|: Still Picture

### Tape Speed Lights

This light indicates the current tape speed. This VCR will play tapes recorded in LP speed, but LP will not appear on the display panel. This VCR will not record in LP speed. *Details are on pages 37 and 52.*

### VCR Light

This light appears when the VCR is in VCR position.

### Cassette-Inside Light

This light appears when a tape is in the VCR. It blinks when a tape is being ejected. This light blinks rapidly if the VCR is turned off to set a Timer Recording but there is not a tape in the VCR.

### Clock/Counter/Channel Display

Each time you press the EXIT/STATUS button, information on the display panel will change. When tape playback is stopped, press the EXIT/STATUS button repeatedly to see: the current time (when the clock is set); the real-time counter; and the current channel number. During tape playback, press the EXIT/STATUS button repeatedly to see the real-time counter or the current time. If a dash (-) appears to the right of the clock when the VCR power is off, Child Lock is activated. *Details are on page 49.*

### Line Input Mode

When L-F appears on the display panel, you have selected A/V IN FRONT. Your audio and video cables should be connected to the AUDIO/VIDEO jacks on the front of the VCR if you are dubbing tapes.

When L-1 appears here, you have selected A/V IN REAR. Your audio and video cables should be connected to the AUDIO/VIDEO jacks on the back of the VCR if you are dubbing tapes.

To select A/V IN FRONT or A/V IN REAR, press 0,0, then press the CH(annel) ▲/▼ button so that A/V IN FRONT or A/V IN REAR appears on the screen briefly.

To exit Line Input mode, press the Number buttons or the CH(annel) ▲/▼ button to select another channel.

## STOP/EJECT Button

Press once to stop the tape. When tape playback is stopped, press to eject the tape.

## FF (Fast Forward) Button

When tape playback is stopped, press to fast forward the tape at high speed. During tape playback, press to fast forward the tape while the picture stays on the screen. *Details are on page 48.*

## POWER Button

Press to turn the VCR power on and off.

## STILL/PAUSE Button

During tape playback, press once to freeze the picture. Press repeatedly to advance the Still picture frame by frame. Press and hold for three seconds to start Slow Motion playback. *Details are on page 48.* During recording, press to temporarily stop the recording. *Details are on page 29.*

## REW(ind) Button

When tape playback is stopped, press to rewind the tape at high speed. During tape playback, press to rewind the tape while the picture stays on the screen. *Details are on page 48.*

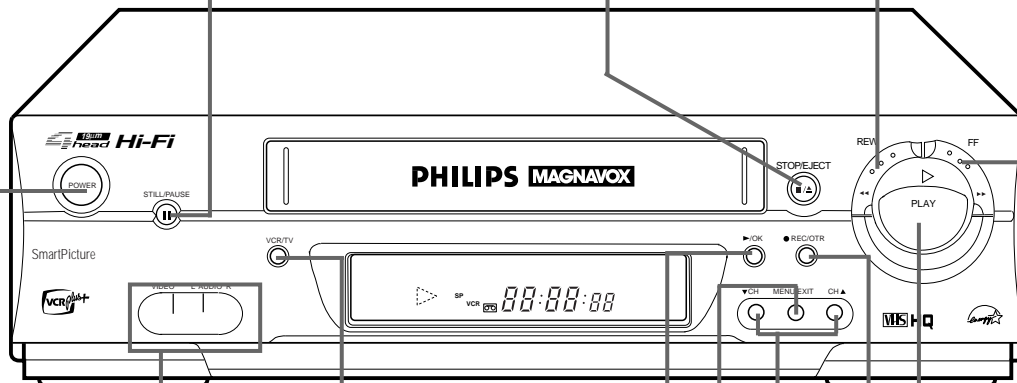

## Front VIDEO/AUDIO In Jacks

Connect cables coming from the VIDEO and AUDIO OUT Jacks of another VCR or a camcorder here. *Details are on page 41.* To access these jacks, gently flip down the plastic cover.

## ▶/OK Button

Press to change the setting of a menu item or to advance to another menu.

## MENU/EXIT Button

Press to access or remove the VCR menu.

## PLAY Button

Press to play a tape. Press to release Slow, Still, or Search mode and return to normal playback. *Details are on page 48.*

## VCR/TV Button

Press to select the signal that your TV receives.

### VCR Position:

Use to watch a tape, to watch a program while recording it, or to watch a TV broadcast using the CH(annel) ▲/▼ or Number buttons to change channels at the VCR. The VCR light will appear on the display panel when the VCR is in VCR position.

### TV Position:

Use to watch TV or to watch one program while recording another. *Details are on page 31.* The VCR light will not appear on the display panel when the VCR is in TV position.

## REC(ord)/OTR Button

Press once to record. *Details are on page 29.* Press repeatedly to start a One-Touch Recording. *Details are on page 30.*

## CH(annel) ▲/▼ Buttons

Press to scan through the VCR's channels. During tape playback, press to manually adjust the tracking. *Details are on page 51.* Press to select an item in the VCR's on-screen menu.



## 24 Rear Panel

### ANT(enna) IN Jack

Connect your antenna or cable here. *Details are on pages 6-9.*

### AUDIO OUT Jacks

Connect cables going to the AUDIO IN jacks of a camcorder, another VCR, or an audio system here. *Details are on pages 41 and 44.*

### AUDIO IN Jacks

Connect cables coming from the AUDIO OUT jacks of a camcorder, another VCR, or an audio source here. *Details are on page 41.*

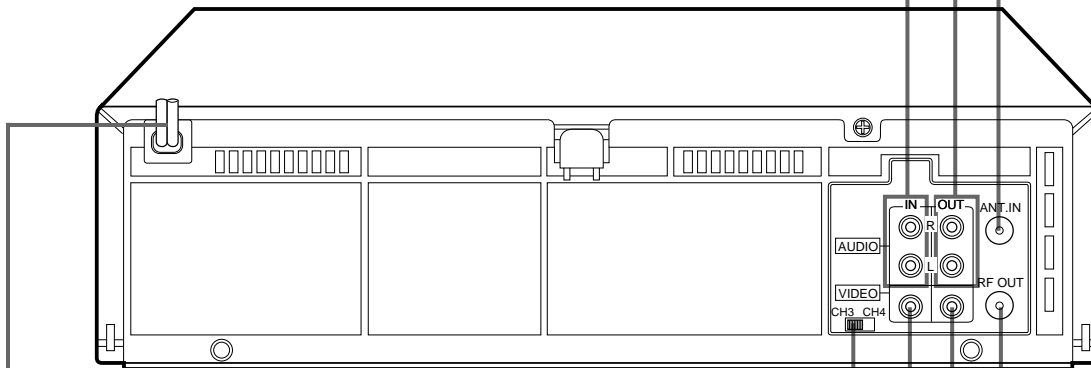

### CH3/CH4 Switch

Set to channel 3 or 4 to use your TV with your VCR. Set your TV to the same channel. *Details are on pages 6-9.*

### VIDEO IN Jack

Connect a cable coming from the VIDEO OUT jack of a camcorder or another VCR here. *Details are on page 41.*

### VIDEO OUT Jack

Connect a cable going to the VIDEO IN jack of a camcorder or another VCR here. *Details are on pages 41 and 44.*

### AC Power Cord

Connect to a wall outlet (120 V) to supply power to the VCR.

### RF OUT Jack

Use the supplied RF coaxial cable to connect this jack to the ANTENNA IN Jack on your TV or to the IN Jack on your Cable Box/DBS (if applicable). *Details are on pages 6-9.*



## On-Screen Status Displays 25

An on-screen status display, which includes the current VCR operation and other information (see illustration), will appear when you press the EXIT/STATUS button or certain function buttons. The contents of the status display will vary.

### ON SCREEN MODE ON:

- Whenever you press the PLAY ▲ button or the STOP ▼ button to stop playback, some of the contents of the status display will appear for five seconds.

### ON SCREEN MODE COUNTER:

- The real-time counter will appear on the screen during normal tape playback and when playback is stopped. Whenever you press the PLAY ▲ button or the STOP ▼ button to stop playback, some of the contents of the status display will appear for five seconds. After five seconds, only the counter will remain on the screen.

### ON SCREEN MODE OFF:

- No status display will appear when you press function buttons or the EXIT/STATUS button.

To select a status display mode, follow these steps.

# 1

Press the VCR button, then press the MENU button.

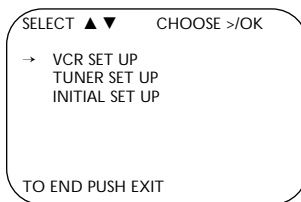

# 2

Press the PLAY ▲ or STOP ▼ button to select VCR SET UP, then press the FF ►/OK button.

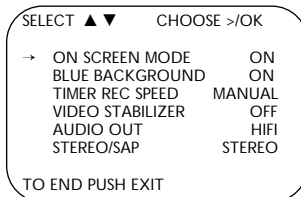

# 3

Press the PLAY ▲ or STOP ▼ button to select ON SCREEN MODE, if necessary.

# 4

Press the FF ►/OK button repeatedly so that ON, COUNTER, or OFF appears beside ON SCREEN MODE.

# 5

Press the EXIT/STATUS button.

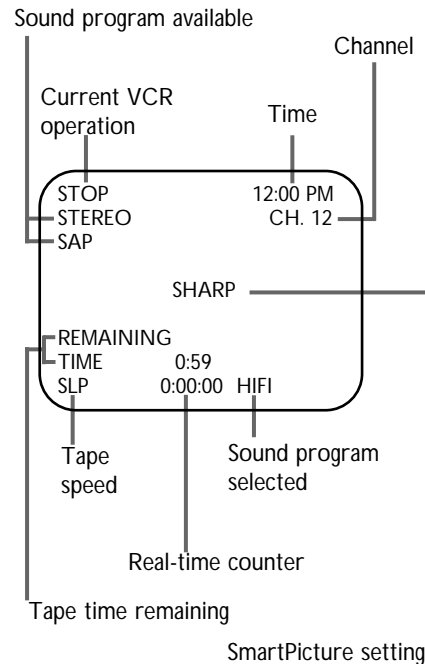

### Helpful Hints

- If ON SCREEN MODE is set to ON or COUNTER:
  - You may bring up the status display at any time by pressing the EXIT/STATUS button. (The exception is during Slow, Search, or Still mode.) The display will appear for about five seconds.
  - Channel numbers (when tuned) will appear for a few seconds.
- When tape playback is stopped, press the EXIT/STATUS button repeatedly to see the current time, real-time counter, or current channel number on the display panel. During tape playback, press the EXIT/STATUS button repeatedly to see the current time or real-time counter on the display panel. The channel will not appear.
- Depending on the type of tape used, the tape time remaining may not appear right away, or may not be correct. Also, "-- : --" may appear, or the display may flash.

## 26 Setting the Remote Control to Operate a TV

Your VCR remote control may operate your TV. Follow these steps to set the remote control code.

# 1

Point the remote control at your TV. Press the **TV** button, then press the **POWER** button. If your TV turns on or off, try the CH(annel) ▲/▼ button. If your remote control operates the TV, you're finished. If your TV doesn't turn on or off, or if the CH(annel) ▲/▼ button doesn't work, go to step 2.

# 2

Find the brand of your TV on the list below, and remember the two-digit number beside it.

TV CODES	
EMERSON . . . . .14	RCA . . . . .10
LG (GOLDSTAR) . . . . .04	SAMSUNG . . . . .18
HITACHI . . . . .12	SANYO . . . . .11
JVC . . . . .05	SHARP . . . . .16
MAGNAVOX . . . .01, 02, 03	SONY . . . . .09
mitsubishi . . . . .13	TOSHIBA . . . . .08
PANASONIC . . . .07, 17	ZENITH . . . . .06, 15
PHILIPS . . . . .01	
PHILIPS MAGNAVOX . . . . .01, 02, 03	

# 3

While you press and hold the **TV** button, press two **Number** buttons to enter the two-digit code for your TV. For example, if you have a Zenith TV, press Number buttons 1, 5. Then, still holding the **TV** button, press the **STOP** ▼ button. Your TV may turn on or off automatically.

# 4

Repeat step 1.

If the remote control works your TV, you're finished. If the remote control still doesn't work your TV, repeat steps 2-3, using a different code for your brand (if available).

# 2

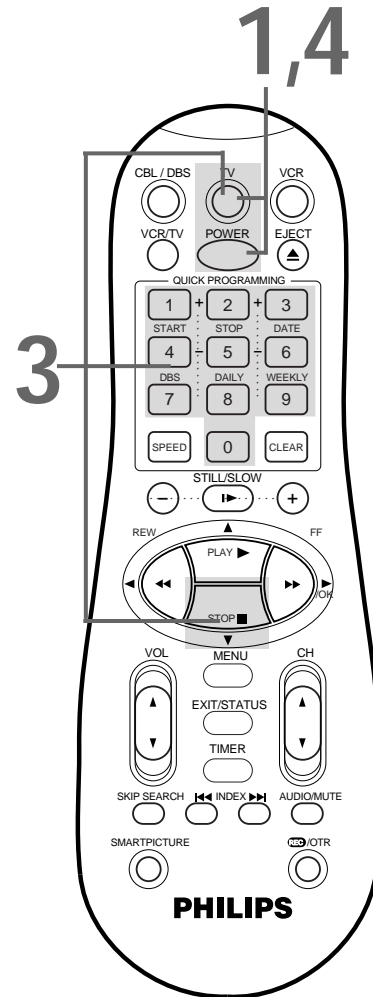
 Find the code for your TV.

### Helpful Hints

- If you had to program the remote control to operate your TV, whenever you replace the batteries in the remote control, you will have to program the remote control again.
- There is no guarantee that the remote control will work your TV.
- The remote control may only operate some features of your TV.

# Setting the Remote Control to Operate a Cable Box/DBS 27

Your VCR remote control may operate your Cable Box/DBS. Follow these steps to set the remote control code.

## 1

Turn on your Cable Box/DBS.

Point the remote control at your Cable Box/DBS. Press the **CBL/DBS** button, then press the **POWER** button. If your Cable Box/DBS turns off, turn on the power again and try the **CH(annel) ▲/▼** button. If the remote control operates the Cable Box/DBS, you're finished. If your Cable Box/DBS does not turn off, or if the **CH(annel) ▲/▼** button doesn't work, go to step 2.

## 2

Find the brand of your Cable Box/DBS on the list below and remember the two-digit number beside it.

CABLE BOX/DBS CODES	
ARCHER . . . . .01, 05, 17	REGAL . . . . .10, 18, 19, 23
CABLETENNA . . . . .01, 17	REGENCY . . . . .19
CABLEVIEW 15, 16, 17, 21, 25	REMBRANDT . . . . .01, 16, 17
CITIZEN . . .15, 16, 17, 21, 25	SAMSUNG . . . . .05, 16, 24
CURTIS . . . . .02, 08	SCIENTIFIC ATLANTA 02, 08
DIAMOND . . . . .01, 17	SIGMA . . . . .07, 20
EASTERN . . . . .19	SL MARX . .05, 16, 17, 24, 25
GC BRAND 15, 16, 17, 21, 25	SPRUCER . . . . .13, 14
GEMINI . . . . .15	STARGATE . .05, 15, 16, 17,
GENERAL INSTRUMENTS	. . . . .21, 24, 25
. . . . .01, 04, 06, 11, 12, 15	TELEVIEW . . . . .05, 16, 24
HAMLIN . . . . .10, 18, 19, 23	TOCOM . . . . .01, 04, 16
JASCO . . . . .15	UNIKA . . . . .01, 17
JERROLD	UNIVERSAL . . . . .16, 17, 25
. . . . .01, 04, 06, 11, 12, 15	VIDEOWAY . . . . .03, 09, 22
NOVAVISION . . . . .02, 08	ZENITH . . . . .03, 09, 22
OAK . . . . .07, 20	
PANASONIC . . . . .13, 14	MAGNAVOX DBS . . .42, 43
PULSAR . . .15, 16, 17, 21, 25	RCA DBS . . . . .40
RCA . . . . .13, 14	SONY DBS . . . . .41

## 3

While you press and hold the **CBL/DBS** button, press two Number buttons to enter the two-digit code for your Cable Box/DBS. For example, if you have a Zenith Cable Box, press Number buttons 0, 3. Then, still pressing the **CBL/DBS** button, press the **STOP ▼** button. The Cable Box/DBS might turn off automatically.

## 4

Repeat step 1. If the remote control still does not work your Cable Box/DBS, repeat steps 2-3 using a different code for your brand, if available.

## 2

Find the code for your Cable Box/DBS.

# 1,4

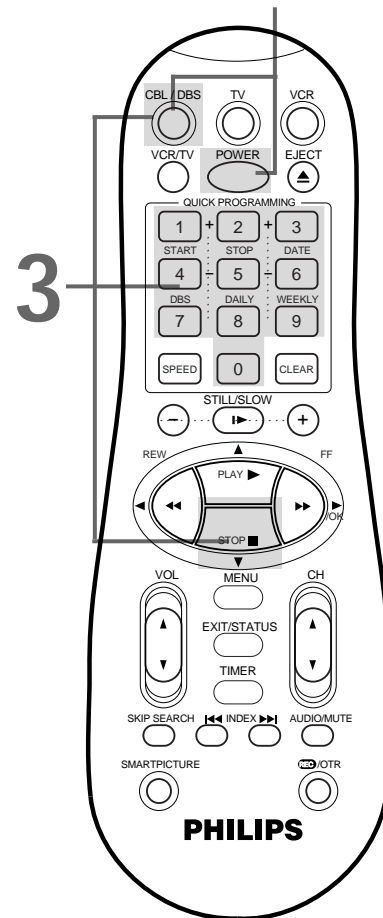

### Helpful Hints

- If you had to program the remote control to operate your Cable Box/DBS, whenever you replace the batteries in the remote control, you must program the remote control again.
- The remote control may only operate some features of your Cable Box/DBS.
- Some Cable Boxes/DBSs can only be turned on at the Cable Box/DBS.
- There is no guarantee that the remote control will operate your Cable Box/DBS.

## 28 Playing

Read and follow the steps below to play a tape.

# 1

Turn on the TV and set it to channel 3 or 4, whichever channel the CH3/CH4 switch on the back of the VCR is set to.

# 2

Insert a tape in the VCR. The power will come on. The VCR will place itself in VCR position automatically (the VCR light will appear on the display panel of the VCR). If the VCR light does not appear, press the VCR/TV button once. If the tape's record tab has been removed, playback will start automatically.

# 3

If playback does not start automatically, press the **PLAY** ▲ button. The ▷ light will appear on the VCR display panel.

# 4

Press the **STOP** ▼ button to stop playback.

# 5

Press the **REW(ind)** ◀ button to rewind the tape.

# 6

Press the **EJECT** button to remove the tape.

# 1

Turn on the TV.

# 2

Insert a tape.

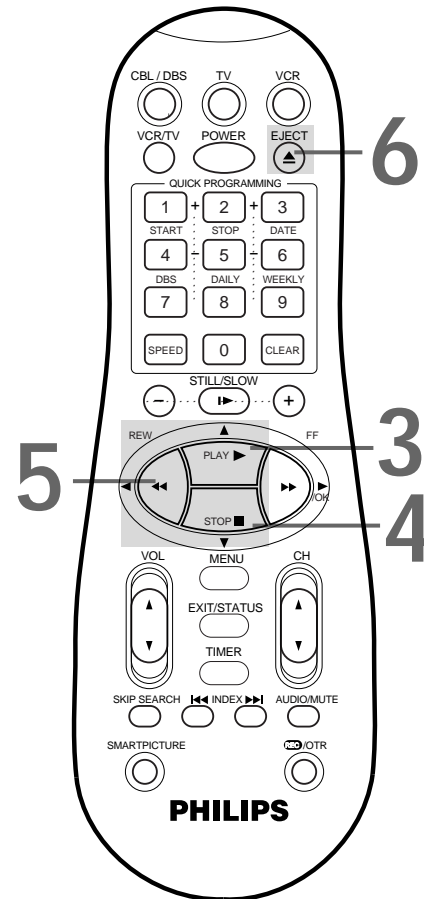

### Helpful Hint

- Playback options and features are on pages 42-48 and 51.
- This VCR is equipped with SQPB (S-VHS Quasi Playback) that lets you watch tapes recorded in the S-VHS format with regular VHS resolution.
  - SQPB does not deliver Super VHS resolution.
  - S-VHS quality recording is not possible with this VCR.

## Recording 29

Read and follow the steps below to record a television program.

**1**

Turn on the TV and set it to channel 3 or 4, whichever channel the CH3/CH4 switch on the back of the VCR is set to.

**2**

Insert a tape with its record tab intact (details are on page 5) in the VCR. The power will come on.

**3**

Press the VCR button.

**4**

If the VCR light appears on the display panel of the VCR, go to step 5. If the VCR light does not appear, press the VCR/TV button once.

**5**

Press the SPEED button until the desired tape speed appears on the screen. The VCR will only record in SP or SLP. Details about tape speed are on pages 37 and 52.

**6**

Use the CH(annel) ▲/▼ button or the Number buttons to select the channel to be recorded.

**7**

Press the REC(ord)/OTR button to start recording. The ○ light will appear on the VCR display panel. If no tape is in the VCR, NO CASSETTE will appear on the screen briefly.

**8**

To pause the recording (for example, during commercials), press the STILL/SLOW button. The ○□□ light will appear on the display panel.

To resume recording, press the STILL/SLOW ► button again. The ○ light will appear on the display panel.

**9**

Press the STOP ▼ button to stop recording. The ○ light will disappear from the display panel.

**1** Turn on the TV.

**2** Insert a tape.

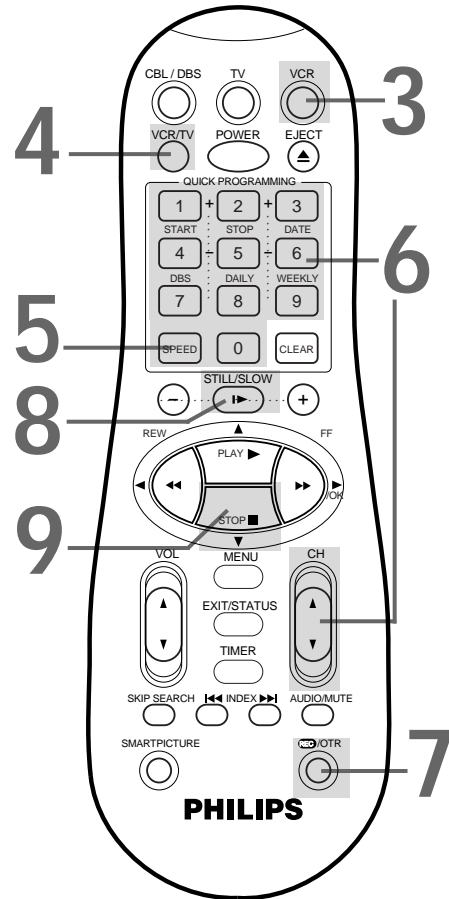

### Helpful Hints

- If the REC(ord)/OTR button is pressed while a tape without a record tab is in the VCR, PROTECTED CASSETTE CANNOT RECORD will appear on the screen briefly. The VCR will eject the tape.
- The VCR records in a preset volume.
- If the end of the tape is reached while recording, the VCR will stop recording, rewind the tape, then stop. Details are on page 51.

## 30 One-Touch Recording

The One-Touch Recording (OTR) function allows you to start an immediate timed recording 30 minutes to six hours long of the channel you are watching. Before you begin, make sure:

- Channels are set up. *Details are on pages 11-12.*
- The desired recording speed (SP or SLP) has been selected with the SPEED button. *Details are on pages 37 and 52.*
- There is a tape in the VCR. Make sure the tape's record tab is intact (see page 5) and the tape is long enough to record the program(s). If the end of the tape is reached during an OTR, recording will stop. The VCR will eject the tape and turn itself off.
- The VCR is in VCR position. (The VCR light will appear on the display panel of the VCR when the VCR is in VCR position. If the VCR light does not appear, press the VCR/TV button once.)

### Starting an OTR

1

Press the VCR button.

2

Use the CH(annel) ▲/▼ button or the Number buttons to select the channel you want to record.

3

Press the REC(ord)/OTR button repeatedly until the desired recording length appears briefly on the screen and on the display panel. The ○ light will flash on the display panel. (The recording length will not appear on the screen if ON SCREEN MODE is set to OFF.)

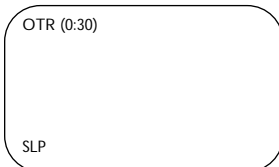

4

To stop an OTR before recording is finished, press the STOP ▼ button.

To cancel the OTR but continue recording, press the REC(ord)/OTR button repeatedly until REC appears in the upper left corner of the TV screen. (ON SCREEN MODE cannot be set to OFF. *Details are on page 25.*) The ○ light will remain on the display panel.

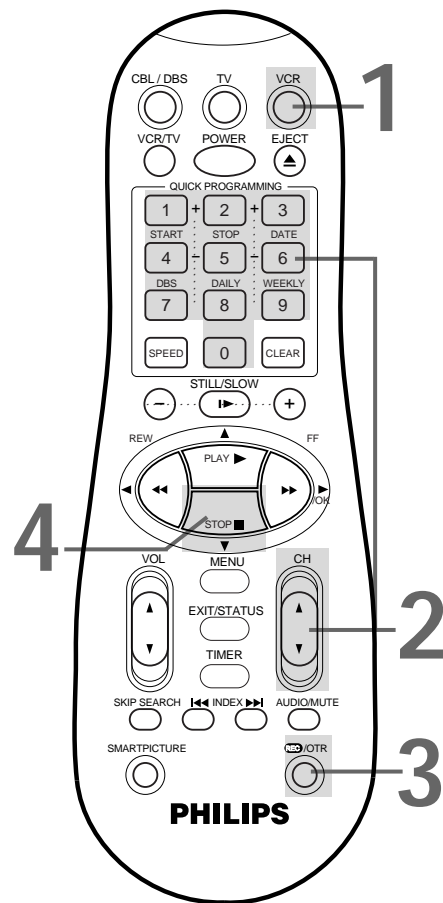

### Helpful Hints

- To check the time remaining for an OTR after the OTR is in progress, press the EXIT/STATUS button. The remaining time will appear on the screen. (The recording length will not appear on the screen if ON SCREEN MODE is set to OFF.)
- To change the recording length while an OTR is in progress, press the REC(ord)/OTR button until the desired length appears on the VCR display panel. The desired length also will appear on the screen if ON SCREEN MODE is set to ON or COUNTER.
- If the preset time for a timer recording comes up during an OTR, the OTR has priority.

## Recording One Channel/Watching Another 31

1

Press the VCR button.

2

Press the REC(ord)/OTR button to start a recording of the current channel. *Details are on page 29.*

3

Press the VCR/TV button to put the VCR in TV position. The VCR light will disappear from the display panel.

4

Use the TV remote control to select the channel you want to watch at the TV. Or, if the VCR remote control operates your TV, press the TV button, then use the CH(annel) ▲/▼ button to select the channel you want to watch at the TV.

The channel selected with the TV controls will appear on the screen while the channel you previously selected to record is being recorded. (The ○ light will appear on the display panel.)

5

To return to the channel being recorded, use the TV remote control to select channel 03 or 04 (whichever channel the CH3/CH4 switch on the back of the VCR is set to). Or, if the VCR remote control operates your TV, press the TV button, then use the CH(annel) ▲/▼ button to select channel 03 or 04.

6

Press the VCR button.

7

Press the VCR/TV button to put the VCR in VCR position. (The VCR light will appear on the display panel.) The channel being recorded will appear on the screen.

8

To stop the recording, press the STOP ▼ button.

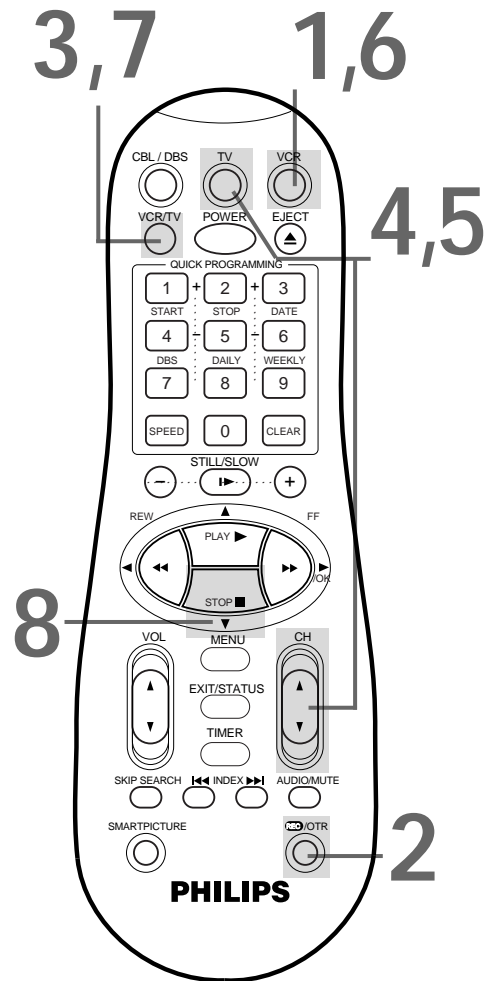

### Helpful Hint

- If you use a Cable Box/DBS, you may not be able to watch one channel while recording another. See pages 8-9 for details.





## Setting Up the VCR Plus+ Programming System (cont'd) 33

# 2

Now, compare the channel numbers you have written into the VCR PLUS+ CH. and CABLE/TV CH. columns. You'll notice that some stations have VCR Plus+ and Cable/TV channel numbers that are the same, and other stations have channel numbers that do not match. You must tell the VCR the VCR Plus+ and Cable/TV channel numbers according to the following steps.

# 3

Press the **VCR** button, then press the **MENU** button.

# 4

Press the **PLAY** ▲ or **STOP** ▼ button to select **INITIAL SET UP**, then press the **FF** ►/OK button.

# 5

Press the **PLAY** ▲ or **STOP** ▼ button to select **VCR PLUS+ CH.**, then press the **FF** ►/OK button.

SET VCR PLUS+ CH.	VCR PLUS+ CH.	CABLE/TV CH.
	99	---
	01	---
	02	---->
	03	---
	04	---

SELECT ▲▼ OR ENTER VCR+ CH. NO. THEN PUSH ►/OK TO END PUSH EXIT

# 6

While a VCR Plus+ channel is flashing, press the **PLAY** ▲ or **STOP** ▼ button repeatedly or press the **Number** buttons so that the arrow appears beside the VCR Plus+ channel number you need. Press the **FF** ►/OK button.

# 7

While the space for the Cable/TV channel is flashing, press the **PLAY** ▲ or **STOP** ▼ button repeatedly or press the **Number** buttons to enter the Cable/TV channel number from the list on page 32. Press the **FF** ►/OK button.

Repeat steps 6-7 until you have entered all the channels on your list.

- If you are using a Cable Box/DBS, the Cable/TV channel will be 3 or 4 (the Cable Box/DBS output channel) for every VCR Plus+ channel. You must set the Cable Box/DBS to the channel you want to record; leave the Cable Box/DBS on for the timer recording.

# 8

Press the **EXIT/STATUS** button.

2 Examine the lists on page 32.

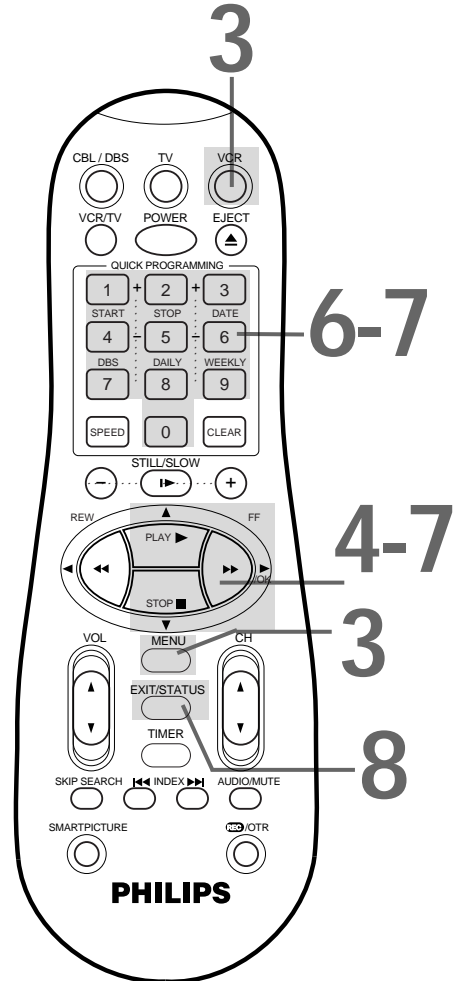

## 34 Timer Recording with the VCR Plus+ Programming System

Follow the steps below to program a timer recording using PlusCode programming numbers. Before you begin make sure:

- Channels are set up. *Details are on pages 11-12.*
- The clock is set. *Details are on pages 13-17.*
- There is a tape in the VCR. Make sure the tape's record tab is intact and the tape is long enough to record the program(s).
- The VCR is in VCR position (the VCR light will appear on the display panel). If the VCR light does not appear, press the VCR/TV button once.
- You have programmed the VCR Plus+ and Cable/TV channel numbers. *Details are on pages 32-33.*

**Complete each step within 60 seconds of completing the previous step. If you don't, you may start again at step 1.**

# 1

Press the VCR button.

# 2

Press the TIMER button.

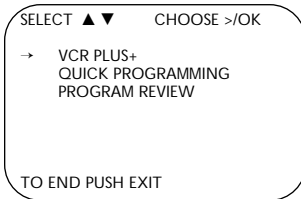

# 3

Press the PLAY ▲ or STOP ▼ button to select VCR PLUS+, then press the FF ►/OK button.

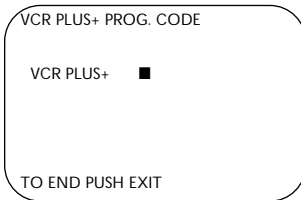

# 4

Use the Number buttons to enter the PlusCode programming number of the program you wish to record. (This number is different for every program.)

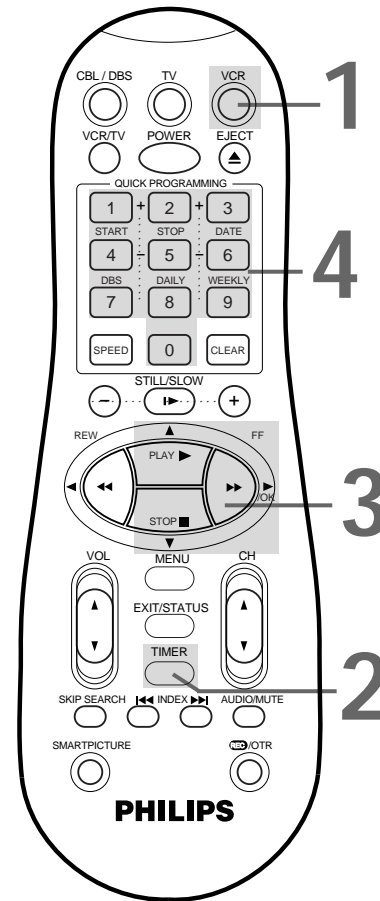
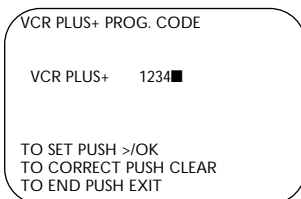

### Helpful Hint

- If you enter an incorrect PlusCode programming number at step 4, ERROR-RE-ENTER CODE will flash on the screen after step 5. Enter the correct PlusCode programming number.

## Timer Recording with the VCR Plus+ Programming System (cont'd) 35

# 5

Press the **FF ►/OK** button. If the VCR PLUS+ and CABLE/TV channel lists appear on the screen, the CABLE/TV channel has not been set for the VCR PLUS+ channel of the program you have set in step 4. Press the Number buttons to enter the CABLE/TV channel number from your list on page 32, then press the **FF ►/OK** button.

# 6

- If you want to record the program one time only, go to step 7. You also may press the Number 8/DAILY or Number 9/WEEKLY button repeatedly to select a ONE TIME PROGRAM.
- If you want to record the program daily, press the Number 8/DAILY button so that **DAILY PROGRAM** appears at the top of the screen. The VCR will record a program every day from Monday through Friday, starting at the same time and recording for the same length of time.
- If you want to record the program every week, press the Number 9/WEEKLY button so that **WEEKLY PROGRAM** appears at the top of the screen. The VCR will record a program on the same day, at the same time, for the same length of time every week.

DAILY PROGRAM (MON-FRI)  
 PROGRAM 1  
 CHANNEL +/- 12  
 START +/- 08:00 PM  
 STOP +/- 10:00 PM  
 REC SPEED SLP  
 DATE +/- 07/31/99  
 SATURDAY  
 SET DAILY=8 OR WEEKLY=9  
 TO END PUSH EXIT

# 7

Press the **SPEED** button to select the tape speed. The selected tape speed, SP or SLP, will appear beside REC SPEED.

# 8

Press the **EXIT/STATUS** button. PROGRAM WAS COMPLETED/PLEASE TURN OFF VCR FOR TIMER RECORDING should appear on the screen. (If PROGRAM NOT COMPLETED appears, begin again from step 1.) After five seconds, the on-screen display will disappear.

# 9

Press the **POWER** button to turn off the VCR. The VCR must be turned off for a timer recording to take place. The  $\odot$  light will appear on the display panel. The  $\odot$  light and the Cassette-Inside light will flash when you turn off the VCR if there is not a tape in the VCR.

**Turn off the VCR for a timer recording! Put a tape in the VCR. Leave the Cable Box/DBS on.**

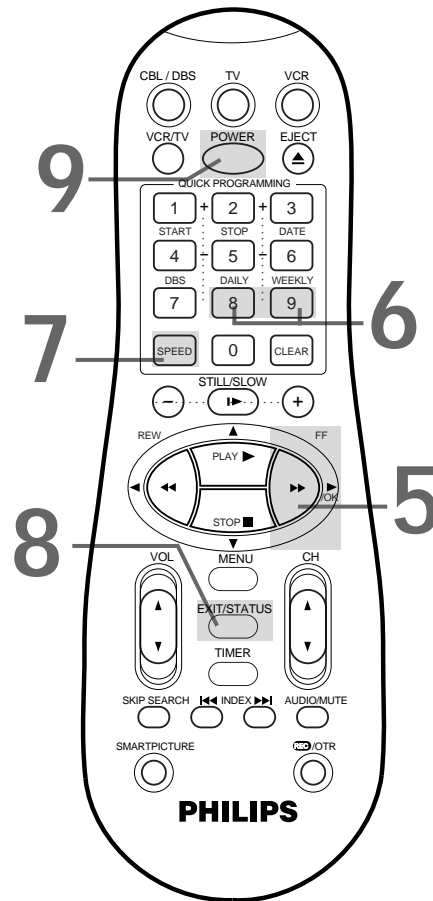

### Helpful Hints

- Do not select DAILY at step 6 if the VCR Plus+ recording you chose is on a Saturday or Sunday. The recording will not occur, even though the VCR may accept the way you programmed the recording.
- To exit the VCR Plus+ programming system at any step, press the EXIT/STATUS button.
- PROGRAM NOT COMPLETED/CLASH may appear on the screen for five seconds at step 8 if the timer recording you programmed overlaps another timer recording. To cancel the overlapping timer recording, follow the steps on page 39.
- If you want to check your timer recordings, follow the steps on page 39.

## 36 Quick Programming

Follow the steps below to program your VCR to record TV programs while you're away from home. The VCR will turn itself on, record, and turn itself off automatically.

Before you begin make sure:

- Channels are programmed. *Details are on pages 11-12.*
- The clock is set. *Details are on pages 13-17.* If the clock is not set, **CLOCK MUST BE SET** appears on the screen, followed by the menu.
- There is a tape in the VCR. Make sure the tape's record tab is intact and the tape is long enough to record the program(s).
- The VCR is in VCR position. The VCR light will appear on the display panel when the VCR is in VCR position. If the VCR light does not appear, press the VCR/TV button once.
- When you use a Cable Box/DBS, timer recordings are programmed differently. Read pages 8-9 before proceeding.

**Complete each step within 60 seconds of the previous step.**

# 1

**Press the VCR button, then press the TIMER button.**

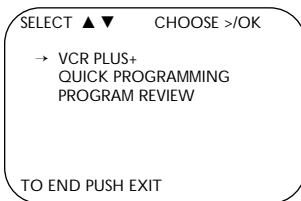

# 2

**Press the PLAY ▲ or STOP ▼ button to select QUICK PROGRAMMING, then press the FF ►/OK button.**

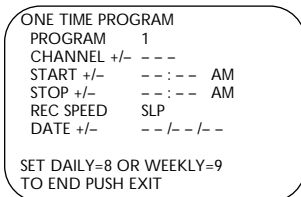

# 3

**Press the CH(annel) ▲/▼ button to enter the channel you want to record.**

- If you are using a standard antenna or cable to VCR to TV hookup (as shown on pages 6-7), enter the channel of the TV program you want to record.
- If you are using a Cable Box/DBS, enter the Cable Box/DBS output channel (03 or 04). Set the Cable Box/DBS to the channel you want to record and leave the Cable Box/DBS on for a timer recording.

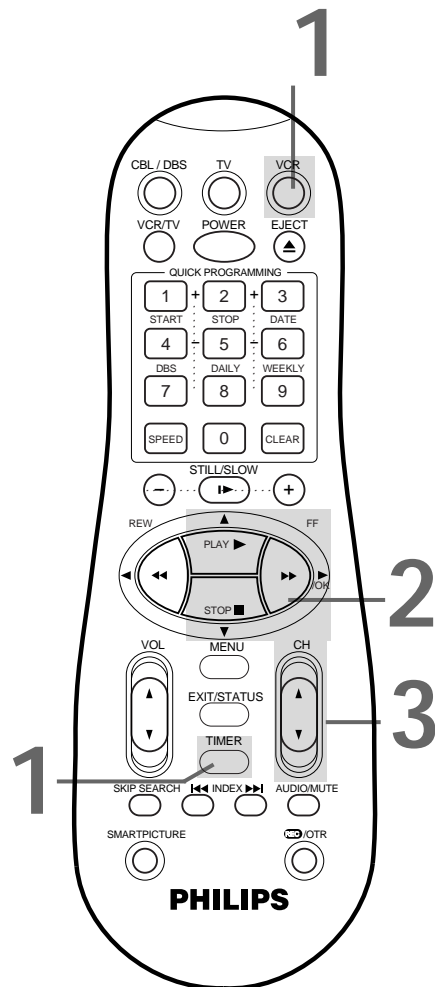
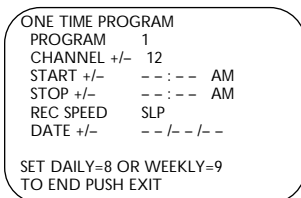

## 4

Press the Number 1/START + or Number 4/START- button to set the recording's start time. Every time you press a button, the start time changes in one-minute increments. If you press and hold a button, the start time changes in 30-minute increments.

```
ONE TIME PROGRAM
PROGRAM      1
CHANNEL +/-  12
START +/-    08:00 PM
STOP +/-     --:-- AM
REC SPEED    SLP
DATE +/-     --/--/--
```

SET DAILY=8 OR WEEKLY=9  
TO END PUSH EXIT

## 5

Press the Number 2/STOP+ or Number 5/STOP- button to set the recording's stop time. Every time you press a button, the stop time changes in one-minute increments. If you press and hold a button, the stop time changes in 30-minute increments.

```
ONE TIME PROGRAM
PROGRAM      1
CHANNEL +/-  12
START +/-    08:00 PM
STOP +/-     10:00 PM
REC SPEED    SLP
DATE +/-     --/--/--
```

SET DAILY=8 OR WEEKLY=9  
TO END PUSH EXIT

## 6

Press the SPEED button to select the tape speed (SP or SLP). Details about tape speed are given below.

```
ONE TIME PROGRAM
PROGRAM      1
CHANNEL +/-  12
START +/-    08:00 PM
STOP +/-     10:00 PM
REC SPEED    SLP
DATE +/-     --/--/--
```

SET DAILY=8 OR WEEKLY=9  
TO END PUSH EXIT

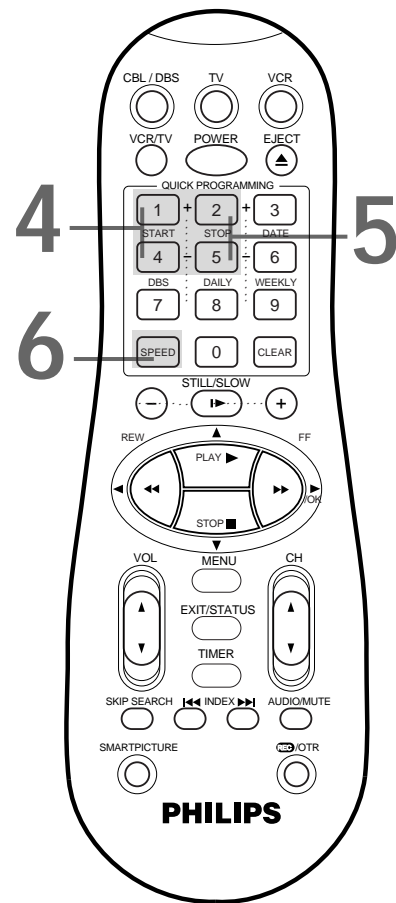

Instructions continue on page 38.

Tape Speeds	Cassette type / Playback Time		
	T160	T120	T60
This chart shows the recording/playback time for T160, T120, and T60 video cassettes. There are three playback speeds: SP, LP, and SLP. This VCR will play tapes recorded in LP, but LP will not appear on the display panel. This VCR will record only in SP and SLP.	Tape Speed		
	SP (standard play)	2 hrs. 40 mins.	2 hrs. 1 hr.
	LP (long play) (playback only)	5 hrs. 20 mins.	4 hrs. 2 hrs.
	SLP (super long play)	8 hrs.	6 hrs. 3 hrs.

## 38 Quick Programming (cont'd)

# 7

Press the Number 3/DATE+ or Number 6/DATE- button to set the recording date. Every time you press a button, the date changes in one-day increments. If you press and hold a button, the date changes quickly. The day of the week will appear automatically. (You cannot program the VCR to record more than one year in advance.)

ONE TIME PROGRAM  
PROGRAM 1  
CHANNEL +/- 12  
START +/- 08:00 PM  
STOP +/- 10:00 PM  
REC SPEED SLP  
DATE +/- 07/31/99  
SATURDAY  
SET DAILY=8 OR WEEKLY=9  
TO END PUSH EXIT

# 8

- If you want to record the program one time only, go to step 9. You may also press the Number 8/DAILY or Number 9/WEEKLY button repeatedly to select a ONE TIME PROGRAM.
- If you want to record the program daily, press the Number 8/DAILY button so that DAILY PROGRAM appears at the top of the screen. The VCR will record a program every day from Monday through Friday, starting at the same time and recording for the same length of time.
- If you want to record the program every week, press the Number 9/WEEKLY button so that WEEKLY PROGRAM appears at the top of the screen. The VCR will record a program on the same day at the same time and for the same length of time every week.

DAILY PROGRAM (MON-FRI)  
PROGRAM 1  
CHANNEL +/- 12  
START +/- 08:00 PM  
STOP +/- 10:00 PM  
REC SPEED SLP  
DATE +/- 07/31/99  
SATURDAY  
SET DAILY=8 OR WEEKLY=9  
TO END PUSH EXIT

# 9

Press the EXIT/STATUS button. PROGRAM WAS COMPLETED/PLEASE TURN OFF VCR FOR TIMER RECORDING will appear on the screen. If PROGRAM NOT COMPLETED appears, try again from step 1.

# 10

Press the POWER button to turn off the VCR. The Ⓞ light will appear on the display panel. (The Ⓞ light and the Cassette-Inside light will flash when you turn off the VCR if there is not a tape in the VCR.) The VCR must be turned off for a timer recording to take place. Leave the Cable Box/DBS on, if applicable.

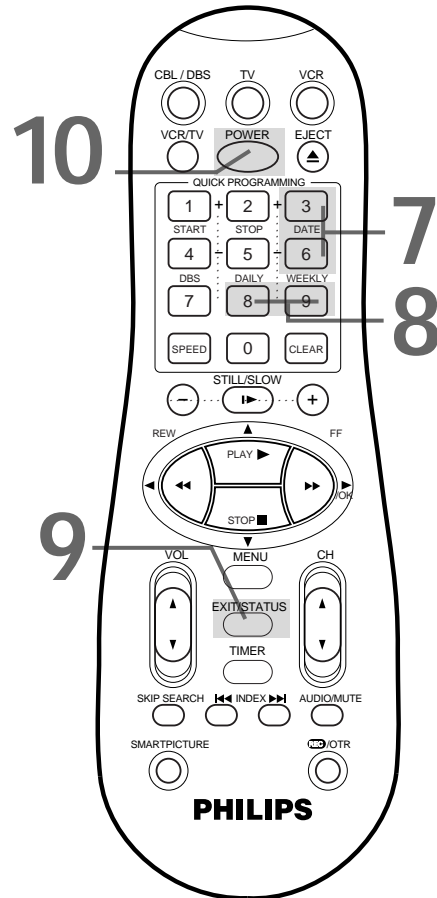

### Helpful Hints

- If you leave the VCR on past the scheduled start time of a timer recording, you will not be asked again to turn off the VCR. The VCR might store the recording for the same time and day in the next year. Or, the VCR may start recording when you turn off the VCR power.
- If the end of the tape is reached during a timer recording, recording will stop. The VCR will eject the tape, then turn itself off.
- If PROGRAM NOT COMPLETED/CLASH appears at step 9, the timer recording you just programmed overlaps another timer recording. The timer recording you just programmed will not take place. The timer recording menu will reappear. To cancel a timer recording, see page 39.
- If you forget to turn off the VCR, PLEASE TURN OFF VCR FOR TIMER RECORDING flashes on your TV screen two minutes before a timer recording starts. To remove the message, press the CLEAR button.

## Checking, Editing, or Clearing Timer Recordings

### 1

Press the **VCR** button, then press the **TIMER** button.

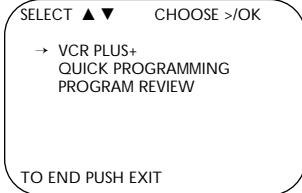

### 2

Press the **PLAY** ▲ or **STOP** ▼ button to select **PROGRAM REVIEW**, then press the **FF** ►/OK button. The list of programmed timer recordings will appear. (If no timer recordings are set, **NO PROGRAM SET** will appear briefly.)

PR	CH	START	STOP	DATE
1	12	08:00P	10:00D	07/31
2	36	10:00A	10:45	08/01
3	24	11:30P	01:00	08/10
4	45	03:00P	03:15W	10/15
5				
6				
7				
8				

NEXT = >      END = EXIT

← *D* indicates a Daily recording.

← *W* indicates a Weekly recording.

### 3

To see the programmed timer recordings individually, press the **FF** ►/OK button. Information for the first program will appear.

ONE TIME PROGRAM	
PROGRAM	1
CHANNEL +/-	12
START +/-	08:00 PM
STOP +/-	10:00 PM
REC SPEED	SLP
DATE +/-	07/31/99
	SATURDAY
TO ERASE PROGRAM = CLEAR	
NEXT = >    PREV = <	END = EXIT

### 4

Press the **FF** ►/OK button repeatedly to review all programmed timer recordings. Or, press the **REW**(ind) ◀ button to return to the previous screen.

### 5

While the information is on the screen, you may change any of the information except the program number. Refer to pages 36-38.

### 6

To cancel the timer recording, press the **CLEAR** button. You will either see the next timer recording or the menu will disappear.

### 7

When all programmed timer recordings have been displayed, the menu will disappear. Or, press the **EXIT/STATUS** button to remove the menu.

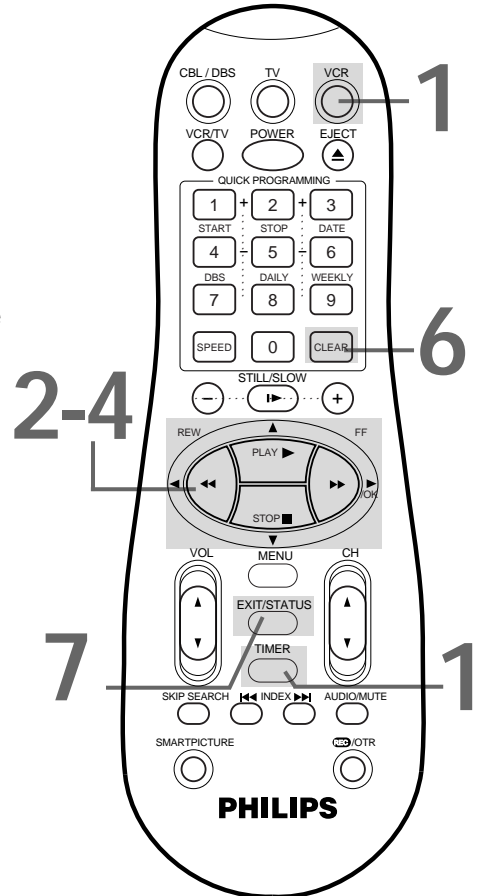

### Helpful Hints

- To stop a timer recording that is in progress, press the **POWER** button on the remote control.
- If you change the time or date and the new time conflicts with another timer recording, the timer recording you are adjusting will be erased. It will not appear in the **PROGRAM REVIEW** menu and will not take place.

See page 54 for more hints.



## 40 Timer Recording Speed Setting

If a program is recording in SP and there is not enough tape to record the entire program, the VCR automatically switches to SLP to allow complete recording if **TIMER REC SPEED** is set to **AUTO**. This feature is especially useful when you set a timer recording for a program that is more than two hours long. For example, when you record a program of 140 minutes in length onto a 120-minute tape, the program is recorded in SP for about 110 minutes and in SLP for about 30 minutes.

Approximately 110 minutes      Approximately 30 minutes

SP	SLP
----	-----

Follow the steps below to set **TIMER REC SPEED** to **AUTO**.

# 1

Press the **VCR** button, then press the **MENU** button.

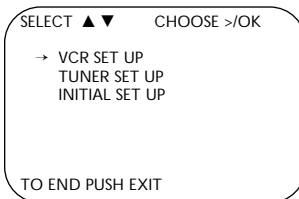

# 2

Press the **PLAY ▲** or **STOP ▼** button to select **VCR SET UP**, then press the **FF ►/OK** button.

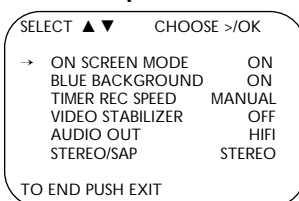

# 3

Press the **PLAY ▲** or **STOP ▼** button to select **TIMER REC SPEED**, then press the **FF ►/OK** button so that **AUTO** appears beside **TIMER REC SPEED**. (To turn off this feature, press the **FF ►/OK** button so that **MANUAL** appears beside **TIMER REC SPEED**.)

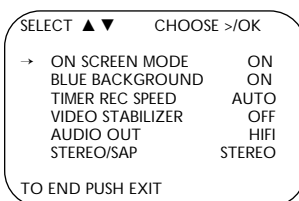

# 4

Press the **EXIT/STATUS** button.

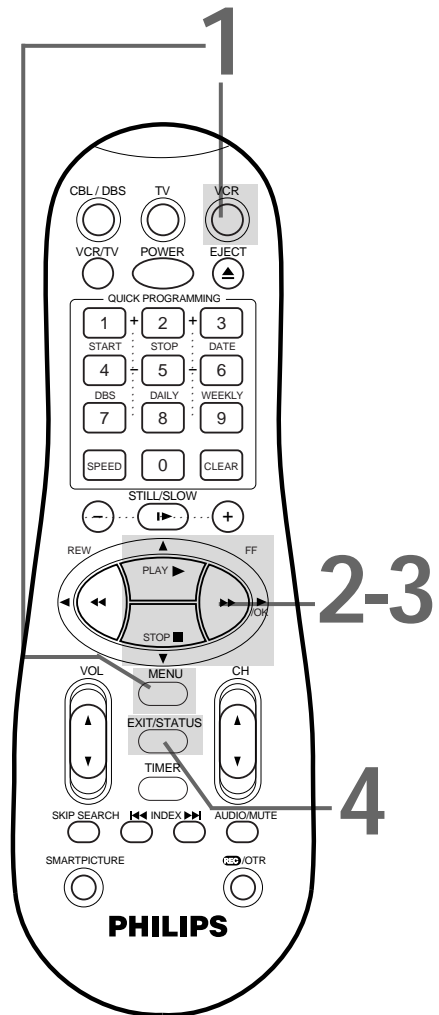

### Helpful Hint

- Some distortion may appear on the tape when the tape speed changes.



## Rerecording (Tape Duplication) 41

The instructions on this page show you how to copy tapes. The illustration uses two VRA641 VCRs. Different VCRs may operate differently. To duplicate a tape, make the connections shown, then follow steps 1-6. (You may use the AUDIO and VIDEO In jacks on the front of VCR 2 instead if you prefer.)

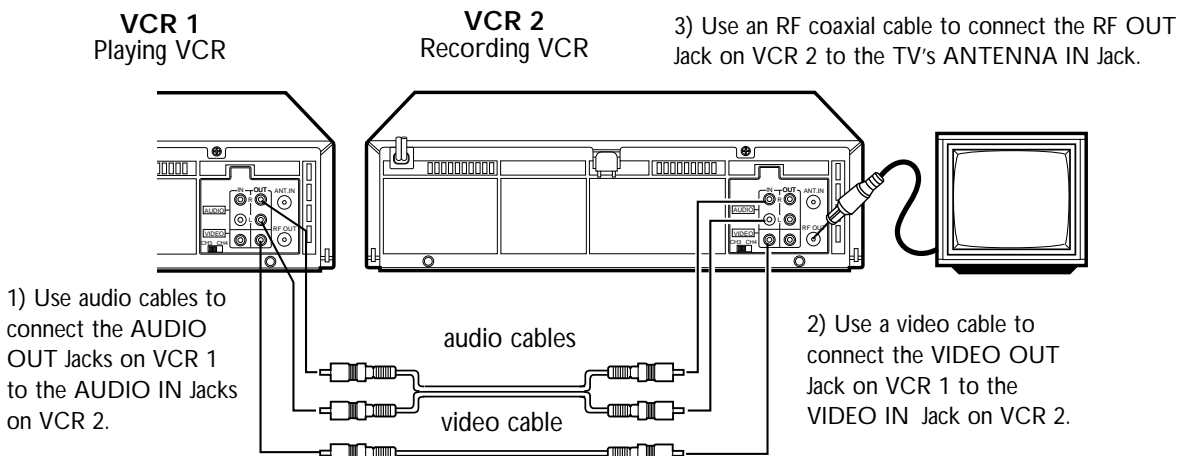

# 1

VCR 1 will play your tape. **Insert a prerecorded tape in VCR 1.** If the tape does not have a record tab, playback begins. If this happens, press the STOP/EJECT button on VCR 1 once.

# 2

VCR 2 will record your tape. **Insert a blank tape in VCR 2. Make sure the VCR power is on and the VCR is in VCR position.** (The VCR light will appear on the display panel. If it does not, press the VCR/TV button once.)

# 3

**Turn on the TV; set it to channel 3 or 4,** whichever channel the CH3/CH4 switch on VCR 2 is set to.

# 4

**Point the remote control at VCR 2. Press the VCR button, then press the Number buttons 0, 0.** Press the CH(annel) ▲/▼ button so that A/V IN FRONT or A/V IN REAR appears on the screen.

# 5

**Point the remote control at VCR 2. Press the SPEED button to select SP or SLP.**

# 6

**Press the PLAY button on VCR 1 and the REC(ord)/OTR button on VCR 2 at the same time.** The ○ light will appear on the VCR 2 display panel.

### Helpful Hints

- *Unauthorized recording of copyrighted television programs, video tapes, or other materials may infringe on the rights of copyright owners and violate copyright laws.*
- *If a program has copy guard protection, it may not record clearly.*
- *Audio and video cables are not included.*
- *To stop copying tapes, press the STOP/EJECT button on VCR 2, then press the STOP/EJECT button on VCR 1.*
- *If you connect the audio and video cables to the AUDIO/VIDEO IN jacks on the front of VCR 2, you must select A/V IN FRONT at step 4. If you connect the audio and video cables to the AUDIO/VIDEO IN jacks on the back of VCR 2, you must select A/V IN REAR at step 4.*

## 42 Index Search

When you make a recording, the VCR automatically places an index code at the beginning of the recording. Essentially, an index code is a type of "bookmark" for your tape. This feature is useful if you have several different programs recorded on a single tape.

Fast forward or rewind to the next or previous index code on the tape by following the steps below.

**1**

Press the VCR button.

**2**

Make sure the VCR is in VCR position. (The VCR light will appear on the display panel when the VCR is in VCR position.) **If the VCR light does not appear, press the VCR/TV button once.**

**3**

Insert a tape in the VCR.

**4**

Press the INDEX **▶▶▶** button to fast forward to the next index code on the tape. Or, press the INDEX **◀◀◀** button to rewind to the previous index code on the tape. Wait for the VCR to fast forward or rewind the tape. When the index code is reached, tape playback will begin automatically.

NOTE: You may press an INDEX button repeatedly to skip over multiple recordings. For example, if you want to fast forward past four recordings, press the INDEX **▶▶▶** button four times. INDEX 4 will appear in the bottom right corner of the screen. The index codes will count down on the screen as the search progresses. (ON SCREEN MODE can not be set to OFF. Details are on page 25.)

**3** Insert a tape.

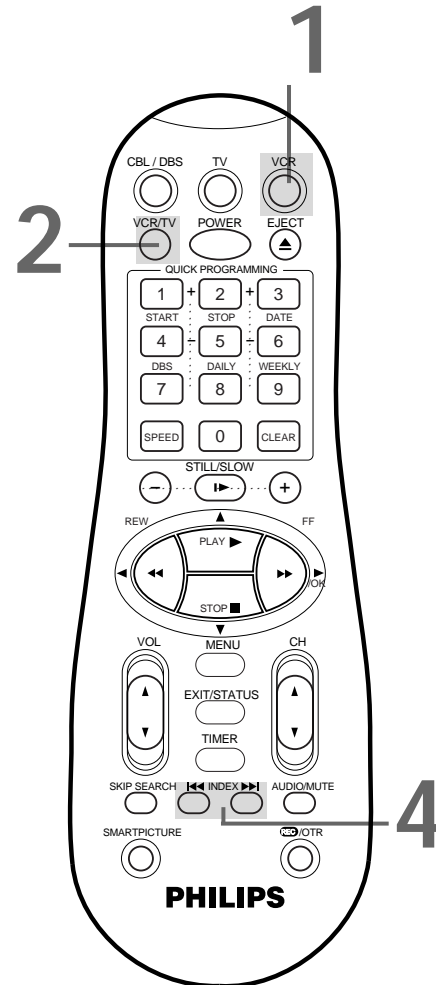

### Helpful Hints

- To stop an Index Search that is in progress, press the STOP ▼ button.
- The VCR does not place an index code at the point where a recording is paused, then resumed.
- INDEX may flash on the screen briefly when you begin a recording.

## Multi-Channel Television Sound System 43

---

The VRA641 can receive and record programs broadcast in stereo or second audio. It can also play back tapes recorded in stereo or second audio.

- **Second Audio** You can program your VCR so you can hear a program that is being broadcast in second audio or a tape that was recorded in second audio. A second audio broadcast is usually a program in a second language. Follow the steps on page 44 to receive or record this type of program.
- **Hi-Fi Stereo Playback** If a tape is recorded in stereo, you can program your VCR to play a tape in Hi-Fi (high fidelity) stereo. Follow the steps on page 45.
- **Hi-Fi Stereo Recording** If a TV program is broadcast in stereo, you can program your VCR to receive and record the program in Hi-Fi stereo. You must program the VCR and make the appropriate stereo hookups. Follow the steps on page 44. To playback this type of program, follow the steps on page 45.

### Receiving a Stereo Broadcast

When a TV program is being broadcast in stereo, STEREO will appear in the on-screen status display. You still have to program your VCR to receive and record the stereo broadcast. Follow the steps on page 44.

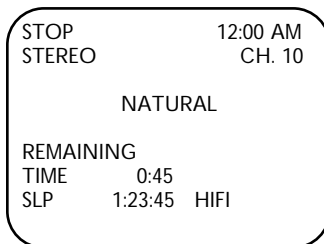

### Receiving a Second Audio Program

If a program is being broadcast in second audio, SAP (Second Audio Program) will appear in the on-screen status display. You still have to program your VCR to receive and record the second audio program. Follow the steps on page 44.

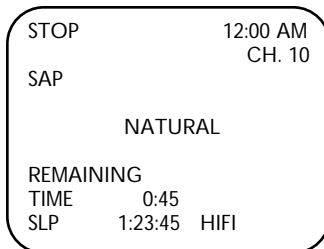

## 44 Multi-Channel Television Sound System (cont'd)

To receive and record programs broadcast in second audio, follow steps 1-6. To receive and record a program broadcast in stereo, make one of the connections shown, then follow steps 1-6.

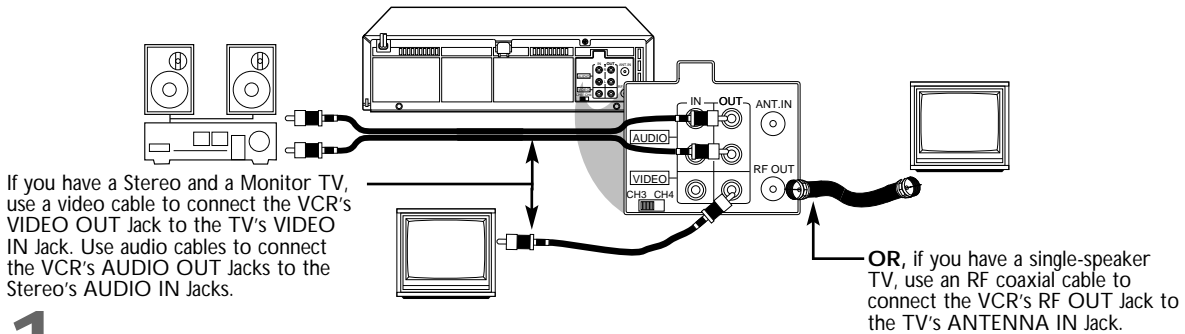

# 1

Press the VCR button, then press the MENU button.

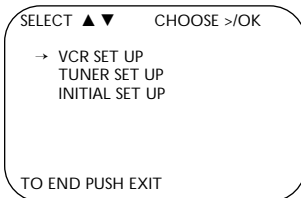

# 2

Press the PLAY ▲ or STOP ▼ button to select VCR SET UP, then press the FF ►/OK button.

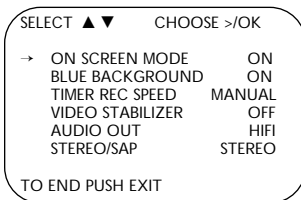

# 3

Press the PLAY ▲ or STOP ▼ button to select STEREO/SAP, then press the FF ►/OK button to select SAP (for a Second Audio Program) or STEREO, whichever you prefer.

# 4

Press the EXIT/STATUS button.

# 5

Use the CH(annel) ▲/▼ button to select a channel to record.

Press the EXIT/STATUS button to access the on-screen status display and to make sure the program is being broadcast in stereo or second audio.

# 6

Press the REC(ord)/OTR button to start recording.

### Helpful Hints

- If you want to connect the VCR to a Stereo TV, follow these steps.
  - 1) Connect the antenna or cable signal to the VCR's ANT(enna) IN Jack.
  - 2) Use stereo audio cables to connect the VCR's AUDIO OUT Jacks to the TV's AUDIO IN Jacks.
  - 3) Use a video cable to connect the VCR's VIDEO OUT Jack to the TV's VIDEO IN Jack.
- Make sure the TV and the Stereo (if applicable) are in Line Input or Auxiliary mode. Please refer to your TV or Stereo owner's manual for

# Hi-Fi Stereo Tape Playback 45

If a tape is recorded in Hi-Fi stereo, follow the steps below to play the tape in Hi-Fi stereo.

# 1

Press the VCR button, then press the MENU button.

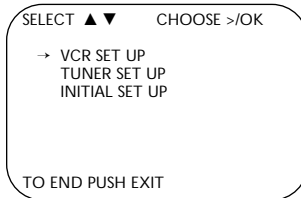

# 2

Press the PLAY ▲ or STOP ▼ button to select VCR SET UP, then press the FF ►/OK button.

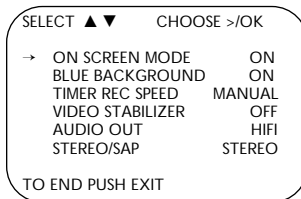

# 3

Press the PLAY ▲ or STOP ▼ button to select AUDIO OUT, then press the FF ►/OK button so that HIFI appears beside AUDIO OUT.

# 4

Press the EXIT/STATUS button.

# 5

Press the PLAY ▲ button to start tape playback.

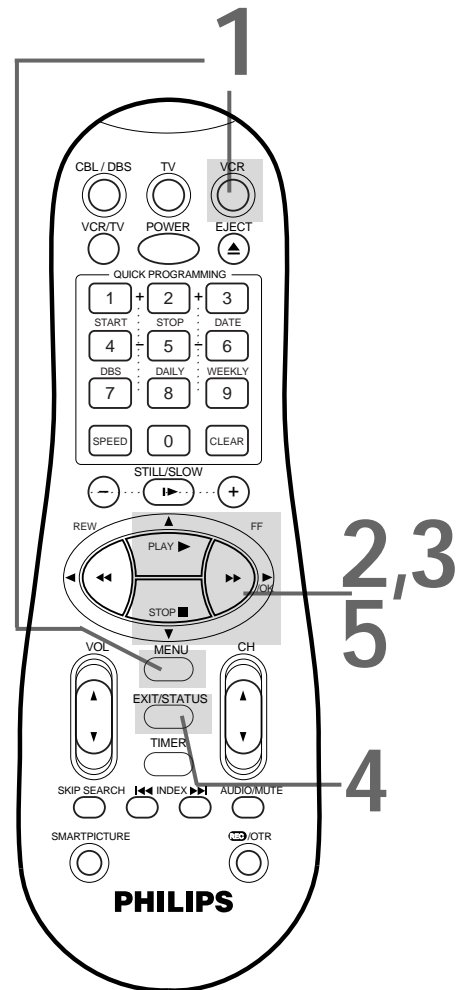

## Helpful Hints

- During playback, Hi-Fi stereo may temporarily revert to normal audio when you adjust tracking. This is normal.
- If Hi-Fi stereo continually reverts to normal audio during playback, you may want to press the FF ►/OK button to select MONO at step 3.
- Only tapes recorded in Hi-Fi stereo will play in Hi-Fi stereo. Tapes recorded in normal audio will play in normal audio.
- You may also select HIFI or MONO by pressing the VCR button, then repeatedly pressing the AUDIO/MUTE button on the remote control.

## 46 Video Stabilizer

You can correct vertical vibration when playing back tapes. When VIDEO STABILIZER is set to ON, vertical vibration will be corrected automatically. VIDEO STABILIZER is set to OFF when you receive the VCR.

Follow the steps below to set VIDEO STABILIZER to ON.

# 1

Press the **VCR** button, then press the **MENU** button.

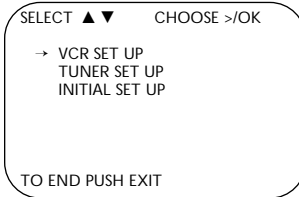

# 2

Press the **PLAY ▲** or **STOP ▼** button to select **VCR SET UP**, then press the **FF ►/OK** button.

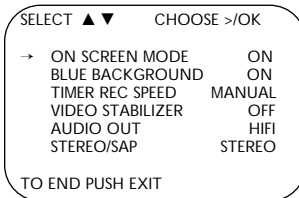

# 3

Press the **PLAY ▲** or **STOP ▼** button to select **VIDEO STABILIZER**, then press the **FF ►/OK** button so that **ON** appears beside **VIDEO STABILIZER**.

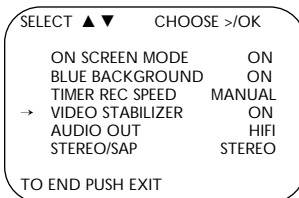

# 4

Press the **EXIT/STATUS** button.

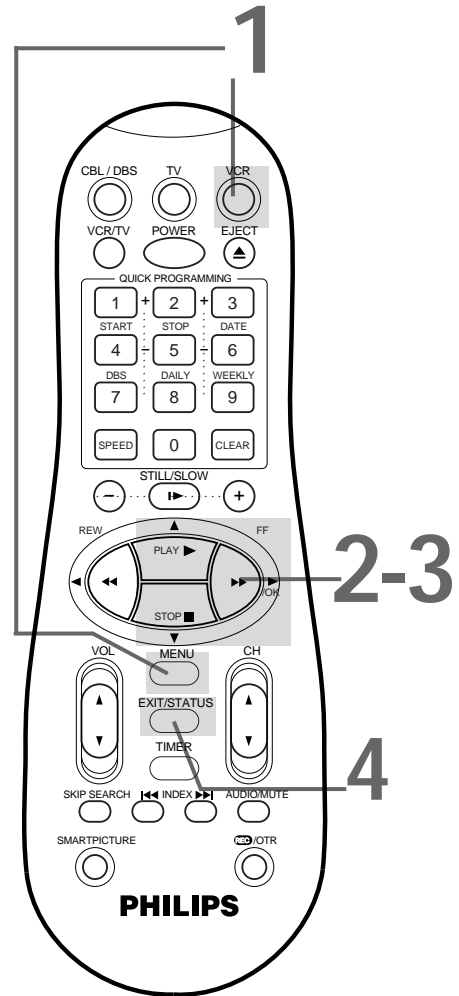

### Helpful Hints

- Regardless of the setting, this feature has no effect during recording, and during special effects playback.
- To set VIDEO STABILIZER to OFF, follow steps 1-2 above. At step 3, press the FF ►/OK button so that OFF appears beside VIDEO STABILIZER. Press the EXIT/STATUS button.

## SmartPicture 47

You can make the tape playback picture softer, sharper, more natural, or more distinct by adjusting the SmartPicture setting. SmartPicture is set to NATURAL when you receive the VCR. Follow the steps below to adjust the SmartPicture setting.

# 1

Press the **VCR** button, then press the **SMARTPICTURE** button. The current setting will appear on the screen for about five seconds.

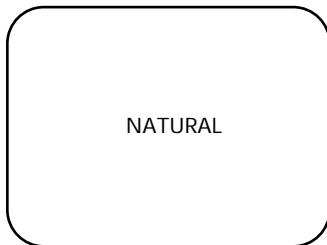

# 2

While the setting appears, press the **SMARTPICTURE** button repeatedly to choose **DISTINCT**, **SOFT**, **SHARP**, or **NATURAL**.

**NATURAL:** This is generally the preferred setting.

**DISTINCT:** Choose to emphasize details in the picture. Choose DISTINCT when you use this VCR as the player (VCR 1) during tape duplication.  
*Details are on page 41.*

**SOFT:** Choose to soften the picture. This setting is recommended if the picture is noisy or has a lot of static.

**SHARP:** Choose to emphasize the edge of the picture.

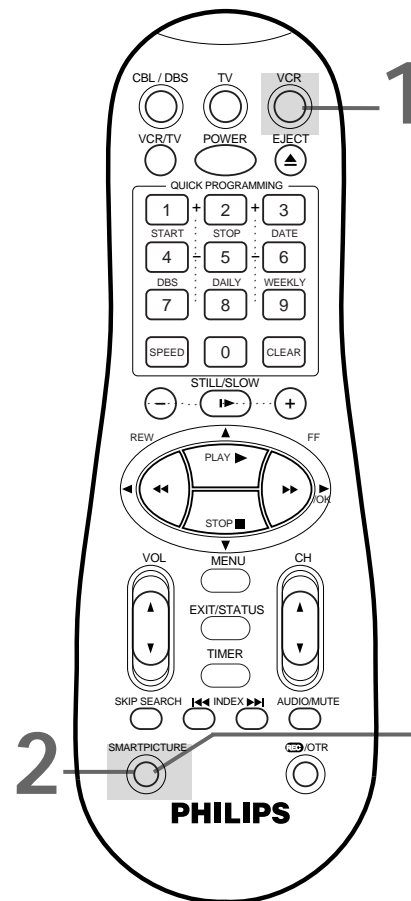

## 48 Playback Options

### Forward and Reverse Searching

1

During tape playback, press and release the **FF ►/OK** button or the **REW(ind) ◀** button. A fast forward or reverse picture search will begin.

2

To return to playback, press the **PLAY ▲** button.

### Viewing a Still Picture

1

During tape playback, press the **STILL/SLOW ►** button. A still picture will appear on the screen.

2

To advance the still picture frame by frame, press the **STILL/SLOW ►** button repeatedly.

3

To return to playback, press the **PLAY ▲** button.

### Viewing a Slow Motion Picture

1

During tape playback, press and hold the **STILL/SLOW ►** button for three seconds. The tape will play in slow motion.

2

During slow motion playback, press the **STILL/SLOW -** button once to slow the speed of slow motion playback. Press the **STILL/SLOW -** button again; the tape will play in reverse slow motion. During slow motion playback, press the **STILL/SLOW +** button to quicken the slow motion playback or to change from reverse slow motion playback to forward slow motion playback.

3

To return to normal playback, press the **PLAY ▲** button.

### Repeat Playback

1

Press and hold the **PLAY ►** button until the **▷** light flashes on the display panel. Now, when a tape has finished playing, the VCR will rewind it and start playback again. The VCR will play the tape 50 times. The **▷** light on the display panel will flash during tape playback and while rewinding. TV programming will appear while the tape is rewinding.

Repeat Playback will be cancelled if you press the **STOP ▼**, **STILL/SLOW ►**, **FF ►/OK**, or **REW(ind)◀** buttons.

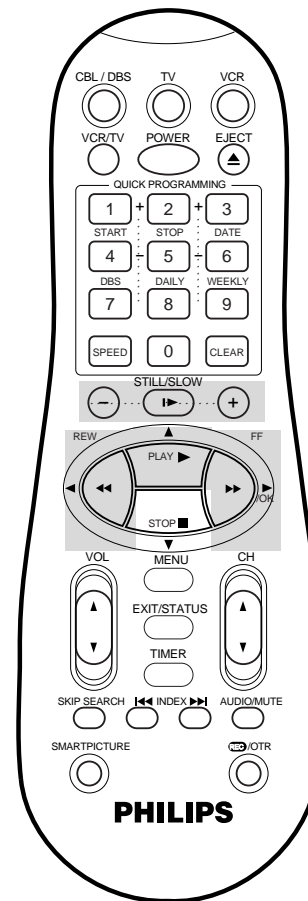

### Helpful Hints

- During Search, Slow, and Still modes, there will be no sound.
- Slow and Still modes automatically switch to Stop mode after five minutes to protect the VCR and the tape from damage.
- During Forward or Reverse Searching, noise bars will appear on the screen.
- You may only view a tape in Slow Motion if the tape is recorded in SP or SLP speed.
- You may press and hold the **FF ►/OK** button or the **REW(ind) ◀** button for a fast forward or reverse picture search. When you release the button, normal playback will resume.



The Child Lock feature disables the buttons on the VCR and remote control.

## 1

When the VCR is on, press and hold the POWER button on the remote control for more than seven seconds until a dash (-) appears to the right of the clock on the display panel. The power will turn off.

### When Child Lock is activated...

- The dash (-) will appear on the display panel.
- The remote control will still operate your TV or Cable Box/DBS if you have set it to do so. Details are on pages 26-27.
- The VCR power will not come on automatically if you insert a tape.
- Timer recordings will take place as scheduled. Make sure a tape is in the VCR. Make sure the VCR power is off before the recording's scheduled start time. The dash (-) will reappear on the display panel when the timer recording is finished.
- If you press the POWER button on the VCR to stop a timer recording that is in progress, recording will stop and Child Lock will be reactivated immediately. Pressing the POWER button on the remote control will not affect the timer recording.

## 2

To cancel Child Lock, press and hold the POWER button on the remote control for more than seven seconds until the VCR power comes on. The dash (-) will disappear from the display panel.

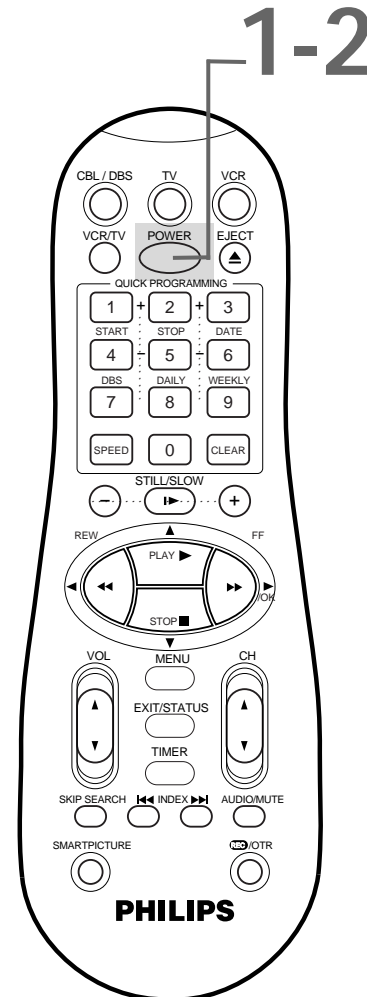

### Helpful Hint

- If you lose your remote control when Child Lock is on, contact Philips.

## 50 Blue Background

If you want the TV screen to be solid blue when a weak signal is received, set BLUE BACKGROUND to ON. The screen will be blue and the sound will be muted. Or, if you want to receive the weak signal, set BLUE BACKGROUND to OFF. When you select a channel that is receiving a weak signal, you will see and hear the static in the TV programming.

When you receive your VCR, BLUE BACKGROUND is set to ON. To set BLUE BACKGROUND to ON or OFF, follow these steps.

# 1

Press the **VCR** button, then press the **MENU** button.

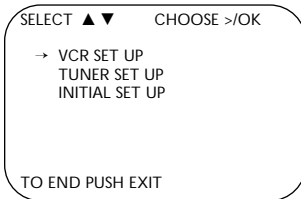

# 2

Press the **PLAY ▲** or **STOP ▼** button to select **VCR SET UP**, then press the **FF ►/OK** button.

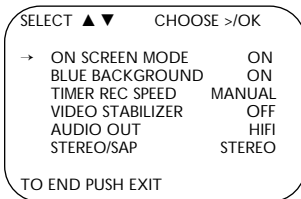

# 3

Press the **PLAY ▲** or **STOP ▼** button to select **BLUE BACKGROUND**, then press the **FF ►/OK** repeatedly so that **ON** or **OFF** appears beside **BLUE BACKGROUND**.

# 4

Press the **EXIT/STATUS** button.

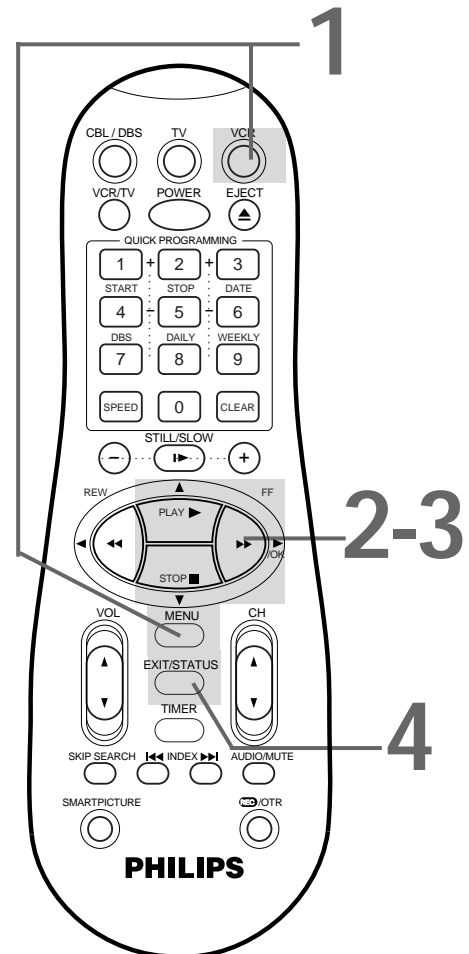

### Automatic Playback

When you put a tape in the VCR, the power will come on automatically. If the tape's record tab is missing, playback will begin.

### Automatic Rewind

When a tape is played, fast forwarded, or recorded to its end, the VCR will rewind the tape to the beginning, then stop. The VCR will not rewind the tape if the end of the tape is reached during a One-Touch Recording. *Details are on page 30.*

### Memory Rewind, Power Off

When the POWER button is pressed while the VCR is rewinding a tape, REWIND→POWER OFF will appear on the screen. When the tape has finished rewinding, the VCR will stop, then turn itself off.

### Tape Eject

A tape can be ejected with the VCR power on or off (but the VCR must be plugged in).

If a timer recording is programmed, the ⊕ and Cassette-Inside lights will flash on the VCR's display panel after you eject a tape with the VCR power turned off.

### Counter Reset

The real-time counter will reset to 0:00:00 when you insert a cassette.

To reset the real-time counter to 0:00:00 at anytime, press the CLEAR button on the remote control.

### Automatic Tracking Adjustment

The VCR continually adjusts tracking to give you the best possible picture quality. With some recordings, however, you may get a better picture by adjusting the tracking manually (see below).

### Manual Tracking Adjustment

- Press the CH(annel) ▲/▼ buttons to remove jitter in a still picture.
- The CH(annel) ▲/▼ buttons adjust tracking during normal tape playback and slow motion picture.
- To return to Automatic Tracking Adjustment, press the CH(annel) ▲/▼ buttons **on the VCR at the same time** except during still picture mode.
- The VCR returns to Automatic Tracking Adjustment whenever a tape is inserted.

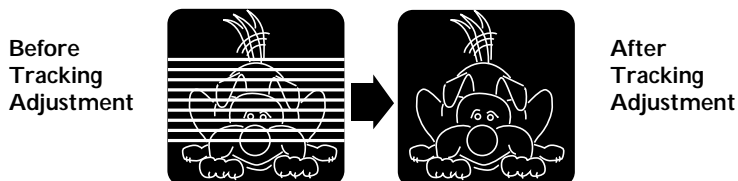

## 52 Glossary

---

**AUDIO IN/OUT Jacks:** jacks located on the front and back of the VCR which are used to record audio from another source (IN) or to send audio to another source (OUT).

**Automatic Channel Programming:** process in which the VCR scans all available channels and places the ones you receive in its memory. Then, when you press the CH(annel) ▲/▼ button, you only scan through channels you receive.

**Bands:** settings that allow you to tune channels.

- **Antenna** – VHF (very high frequency; channels 2 - 13) and UHF (ultra high frequency; channels 14 - 69).
- **Cable** – standard channels can be received without a Cable Box.

**Cable Box/DBS Output Channel:** channel 03 or 04.

**DBS:** Direct Broadcast System.

**Dubbing:** copying a tape using a second VCR.

**Frame:** a single still picture.

**HQ:** high quality; a feature in the VCR circuitry which provides enhanced picture detail.

**OTR:** one-touch recording; a timed recording that starts immediately and records for 30 minutes to six hours, whichever you specify.

**Remote Control:** the small electronic unit that came with your VCR; allows you to operate your VCR from a distance. The remote control also may operate some features of your TV, Cable Box, or DBS.

**RF coaxial cable:** the cable supplied with your VCR. Use it to connect your VCR to your TV (or Cable Box/DBS, if applicable). The supplied cable is a snap-on type. However, you also may use a screw-on type if you prefer.

**Special Effects:** forward and reverse searching; viewing a still picture; or viewing a slow motion picture.

**Tape Speeds:** how fast the tape travels during a recording or playback.

- **LP (long play)** – average tape speed (playback time for a T120 tape is approximately four hours); available for playback only. Although the VCR will play tapes recorded in LP, LP will not appear on the display panel or in the on-screen status display.
- **SLP (super long play)** – slowest tape speed (recording/playback time for a T120 tape is approximately six hours).
- **SP (standard play)** – fastest tape speed (recording/playback time for a T120 tape is approximately two hours); best picture quality.

**VCR:** video cassette recorder.

**VIDEO IN/OUT Jacks:** jacks located on the front and back of the VCR which are used to record video from another source (IN) or to send video to another source (OUT).

**Video Heads**

Four heads with Hi-Fi stereo

**Video Signal**

EIA standards; NTSC color

**Antenna**

VHF/UHF – 75 ohm external antenna terminal

**VHF Output Signal**

Channel 3 or 4 (switchable)

75 ohms unbalanced

**Power Requirement**

120V AC; 60 Hz

**Power Consumption**

19 W

**Operating Temperature**

41°F (5°C) to 104°F (40°C)

**Relative Humidity**

10% to 80%

**Weight**

7.1 lbs. (3.2 kg.)

**Dimensions**

14-3/16" (W) x 3-3/4" (H) x 11-1/8" (D)

(360 mm x 94 mm x 281 mm)

**Tuner Broadcast Channels**

VHF: 2-13

UHF: 14-69

**Cable TV Channels**

VHF: 2 - 13

Midband: A – 1

Superband: J – W

Hyperband: A-5 – A-1

Special Channel: 5A

Ultraband: 37 – 94, 100 – 125

*NOTE: Designs and specifications are subject to change without notice.*

## 54 Helpful Hints

---

If you are having problems with your VCR, check the following list of problems and possible solutions before requesting service. You may be able to solve the problem yourself.

If you need to call a customer service representative, please know the model number and serial number of your product before you call. This information is displayed on the back of the product. Also, please take a moment to identify the problem you are having, and be prepared to explain this to the representative. If you believe the representative will need to help you with operations, please stay near the product. Our representatives will be happy to assist you.

### **The VCR has no power.**

- Make sure the power plug is completely connected to an AC (alternating current) outlet.
- Make sure the power is turned on.

### **A power failure occurred.**

- Select a language and set up channels, if prompted to do so. *Details are on pages 11-12 and 19.* Reset the clock if necessary. *Details are on pages 13-17.* You also may need to reprogram your timer recordings. *Details are on pages 32-39.*

### **The VCR cannot be controlled with the remote control.**

- Aim the remote control directly at the VCR's remote sensor. *Details are on pages 5 and 22.*
- Remove all obstacles between the remote control and the VCR.
- Inspect and/or replace the batteries in the remote control. *Details are on page 5.*
- Press the VCR button, then try the other buttons.

### **The VCR does not respond normally to the remote control. (For example, the VCR may change channels multiple times when you press the CH(annel) ▲ button once.)**

- Install new batteries (preferably alkaline) in the remote control.

### **The VCR will not perform a timer recording.**

- Make sure the recording start and stop times are set correctly. *Details are on pages 32-39.*
- Make sure there is a tape in the VCR.
- Make sure the tape has a record tab. *Details are on page 5.*
- Make sure the VCR power is off.
- Make sure the clock is set. *Details are on pages 13-17.*
- The VCR may not perform or continue a timer recording if a power interruption of more than 10 minutes occurs, even if the power comes back on. If timer recordings are lost, - - : - - should appear on the display panel. But, even if you do not see this indication and the VCR operates normally, check programmed timer recordings.
- When you turn on the VCR after a power failure, this on-screen message may appear: POWER FAILURE OCCURRED/TIMER MEMORY CLEARED (IF PROGRAMMED)/PLEASE SET PROGRAMS TO BE RECORDED/TO END PUSH EXIT. First, reset the clock. *Details are on pages 13-17.* Then, set up channels. *Details are on pages 11-12.* Finally, program the timer recordings again. *Details are on pages 32-39.*
- Finish programming a timer recording at least five minutes before the recording is scheduled to begin.
- If the VCR power is turned off for a timer recording and there isn't a tape in the VCR, the ⊖ and Cassette-Inside lights will blink on the display panel.
- If the record tab on a tape is missing and you turn off the VCR to set a timer recording, the VCR will eject the tape. The ⊖ and Cassette-Inside lights will blink on the display panel.
- Noon is 12 p.m.; midnight is 12 a.m.
- If you are using a Cable Box/DBS, enter the Cable Box/DBS output channel (03 or 04) at step 3 on page 36, then select the channel to be recorded at the Cable Box/DBS. Leave the Cable Box/DBS on for the timer recording.

### **Tape can't be inserted.**

- Insert the tape window side up, with the record tab facing you.
- Make sure a tape isn't already in the VCR by pressing the STOP/EJECT button on the VCR or the EJECT button on the remote control.
- Gently push the center of the tape as you put it in the VCR. Never force a tape into the VCR.

### **Tape can't be removed.**

- Make sure the power plug is completely connected to an AC (alternating current) outlet.

### **The motor (cylinder) rotates even when the VCR is in Stop mode.**

- To enable the quick play mechanism, the cylinder will rotate for about five minutes. This is normal. The quick play mechanism enables the tape mechanism to switch from Stop mode to Play mode in one second.

### **There is no playback picture, or the playback picture is noisy or contains streaks.**

- Make sure the TV is on the same channel as the VCR's CH3/CH4 switch. *Details are on pages 6-9.*
- Make sure the VCR is in VCR position. *Details are on pages 21-22.*
- Make sure channel 3 or 4 is properly adjusted at the TV.
- Adjust the tracking. *Details are on page 51.*

### **The Number buttons won't work for channels above 69; channels above 13 cannot be received.**

- Select CABLE at the TUNER SET UP menu, then let the VCR set up the channels. *Details are on page 11.*

### **A TV program cannot be recorded.**

- Check the connections between the VCR, TV, antenna/cable, and Cable Box/DBS (if applicable). *Details are on pages 6-9.*
- Make sure channels are programmed correctly. *Details are on pages 11-12.*
- Make sure the tape has a record tab. *Details are on page 5.*

### **TV programs cannot be watched normally.**

- Put the VCR in TV position. *Details are on pages 21-22.*
- Check the connections between the VCR, TV, antenna/cable, and Cable Box/DBS (if applicable). *Details are on pages 6-9.*

### **Line Input mode is selected.**

- If you accidentally enter Line Input mode (L-1 or L-F will appear on the display panel), use the CH(annel) ▲/▼ button or the Number buttons to select another channel.

### **Multi-Channel Television Sound System**

- You can only receive and record in stereo or second audio programs that are broadcast in stereo or second audio. You can only play in stereo or second audio tapes that were recorded in stereo or second audio. *Details are on pages 43-45.*
- If you select second audio when second audio is not available, the VCR will record normal audio.
- When you program your VCR to record in stereo, broadcasts are recorded in Hi-Fi stereo.
- You will only get stereo sound if you use audio cables to connect the AUDIO OUT Jacks on the VCR to the AUDIO IN Jacks on your TV. The TV must be in Line Input mode. See your TV owner's manual for details.
- When you connect the AUDIO OUT Jacks on your VCR to the AUDIO IN Jacks on your TV, the stereo light on the TV might not glow. This is normal. If the VCR indicates you are receiving a stereo broadcast, you are. (STEREO will appear in the status display.)

### **The VCR ejects the tape when the REC(ord)/OTR button is pressed or when the VCR power is turned off to set a timer recording.**

- Make sure the tape has a record tab. *Details are on page 5.*

### **The remote control is not available or the remote control will not access the VCR's on-screen menu.**

- Use the front panel buttons to access the menu. You cannot access the TIMER menu using the front panel buttons. *Details are on page 23.*

**RENEWED  
90 DAY  
LIMITED WARRANTY**



- 
- ac power cord . . . . .24
  - accessories . . . . .60
  - ant(enna) in jack . . . . .6-9, 24
  - audio in/out jacks .23-24, 41, 44,52
  - audio/mute button . . . . .21
  - automatic
    - playback . . . . .51
    - rewind . . . . .51
  - batteries . . . . .5
  - blue background . . . . .50
  - cable box
    - codes . . . . .27
    - connections . . . . .8-9
    - output channel . . . . .8-9, 52
  - cable/tv channels . . . . .32-33
  - cassette compartment . . . . .22
  - cassette-inside light . . . . .22
  - cbl/dbc button . . . . .20, 27
  - ch3/ch4 switch . . . . .7, 24
  - ch(annel) ▲/▼ buttons .20, 23, 51
  - channel
    - adding . . . . .12
    - deleting . . . . .12
    - display . . . . .22
    - setup . . . . .11
  - child lock . . . . .49
  - clear button . . . . .20
  - clock
    - display . . . . .22
    - setting . . . . .13-17
      - automatically . . . . .16-17
      - manually . . . . .13-14
      - time zone selection . . . . .15
  - connections . . . . .6-9, 41, 44
  - contents, table of . . . . .4
  - controls
    - remote . . . . .20-21
    - vcr . . . . .22-24
  - daily button . . . . .34-38
  - date +/- buttons . . . . .36-38
  - daylight-savings time . . . . .18
  - dbc
    - codes . . . . .27
    - connections . . . . .8-9
  - display panel . . . . .22
  - duplication . . . . .41
  - eject button . . . . .20
  - erase protection . . . . .5
  - exit/status button . . . . .21
  - fast forward searching . . . . .48
  - ff button . . . . .23
  - ff ►/OK button . . . . .20
  - /OK button . . . . .23
  - frame advance . . . . .48
  - front panel . . . . .23
  - glossary . . . . .52
  - helpful hints . . . . .54-55
  - hi-fi stereo playback . . . . .45
  - hookups
    - with a cable box/dbc . . . . .8-9
    - without a cable box/dbc . . . . .6-7
  - index buttons . . . . .21, 42
  - index search . . . . .42
  - language selection . . . . .19
  - limited warranty . . . . .56
  - line input mode . . . . .22, 41
  - long play . . . . .37, 52
  - lp . . . . .37, 52
  - maintenance . . . . .5
  - menu button . . . . .20
  - menu/exit button . . . . .23
  - mts broadcast . . . . .43-44
  - number buttons . . . . .20
  - on-screen mode . . . . .25
  - one-touch recording . . . . .30
  - operation indicators . . . . .22
  - output channel . . . . .8-9, 52
  - pbs channel selection
    - automatic . . . . .17
    - manual . . . . .16
  - play button . . . . .20, 23, 28
  - playback
    - options . . . . .48
  - pluscode programming number .34
  - power button . . . . .20, 23
  - program review . . . . .39
  - quick programming . . . . .36-39
  - real-time counter . . . . .25, 51
  - rear panel . . . . .24
  - rec(ord)/otr button . .20, 23, 29-30
  - record tab . . . . .5
  - recording
    - basic . . . . .29
      - one channel/watching . . . . .31
      - another . . . . .31
    - remote control
      - buttons . . . . .20-21
      - sensor . . . . .22
      - using . . . . .5
    - repeat playback . . . . .48
    - rerecording . . . . .41
    - reverse searching . . . . .48
    - rew(ind) ◀ button . . . . .20, 23, 48
    - rf coaxial cable . . . . .7-9, 52
    - rf out jack . . . . .6-9, 24
  - safety precautions . . . . .3
  - second audio broadcast . . . . .43-44
  - skip search button . . . . .21
  - slow motion . . . . .48
  - slp . . . . .37, 52
  - smartclock . . . . .16-17
  - smartpicture . . . . .47
  - sp . . . . .37, 52
  - specifications . . . . .53
  - speed button . . . . .21
  - sqpb . . . . .28
  - standard play . . . . .37, 52
  - start +/- buttons . . . . .36-38
  - stereo broadcast . . . . .43-44
  - still/pause button . . . . .23
  - still/slow buttons . . . . .21
  - still picture . . . . .48
  - stop ▼ button . . . . .20
  - stop +/- buttons . . . . .36-38
  - stop/eject button . . . . .23
  - super long play . . . . .37, 52
  - table of contents . . . . .4
  - tape
    - duplication . . . . .41
    - eject . . . . .51
    - speed . . . . .37, 52
    - speed lights . . . . .22
    - time remaining . . . . .25
  - time zone selection . . . . .15
  - timer
    - button . . . . .21
    - light . . . . .22
    - recording . . . . .34-39
      - checking . . . . .39
      - clearing . . . . .39
      - helpful hints . . . . .54
      - programming . . . . .34-38
      - reviewing . . . . .39
      - speed setting . . . . .40
      - with vcr plus+ programming system32-35
  - tracking adjustment . . . . .51
  - tv
    - button . . . . .20
    - controls . . . . .26
    - hookups . . . . .6-9, 44
    - position . . . . .21
    - remote control code . . . . .26
  - vcr
    - button . . . . .20
    - light . . . . .22
    - position . . . . .21
    - vcr plus+ channels . . . . .32-33
    - vcr plus+ programming system
      - setting up . . . . .32-33
      - timer recording . . . . .34-35
  - vcr/tv button . . . . .21, 23
  - video
    - in/out jacks . . . . .23-24,41,44,52
    - stabilizer . . . . .46
    - tapes . . . . .5, 37
  - vol(ume) ▲/▼ button . . . . .20
  - warranty . . . . .56
  - weekly button . . . . .34-38





# SUPPLIED ACCESSORIES

*The following items are supplied with your VCR; they are provided to help you use or set up your VCR.*

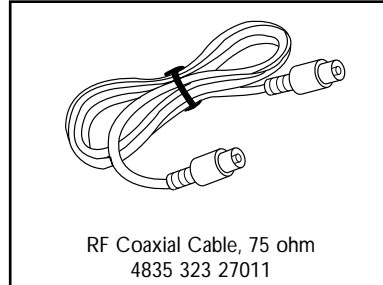

# OPTIONAL ACCESSORIES

*The following additional items are not provided with your VCR, but they are designed for use with your new VCR. To order these optional accessories, contact us at:*

**Philips Parts & Accessories Marketing Department  
401 East Old Andrew Johnson Highway  
P.O. Box 555  
Jefferson City, TN 37760  
1-800-851-8885.**

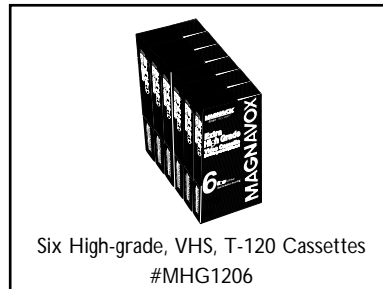
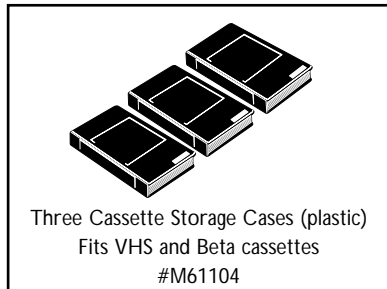
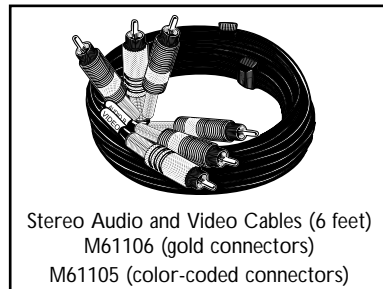

This owner's manual is made of recyclable materials.  
Remember to recycle!



As an ENERGY STAR® Partner, Philips Consumer Electronics Company has determined that this product meets the ENERGY STAR® guidelines for energy efficiency. ENERGY STAR® is a U.S. registered mark.

