

OWNER'S MANUAL

LS6000, LS6300

AM/FM Stereo Receiver and Auto Stop Cassette Player

Designed for In-Wall Installation of All Recreational Vehicles, Motor Homes and Mobile Housings

12 Volts DC

**LINEAR
SERIES**

A Registered Trademark of Magnadyne Corporation

INTRODUCTION

Please read all of the information in this booklet before using this unit to insure that you fully understand the capabilities of this unit.

WARNING! To prevent fire or electrical shock hazard, do not expose this product to rain or moisture, or remove cover or bottom screws. No user serviceable parts inside. Refer servicing to qualified service personnel.

CONTROLS AND FUNCTIONS

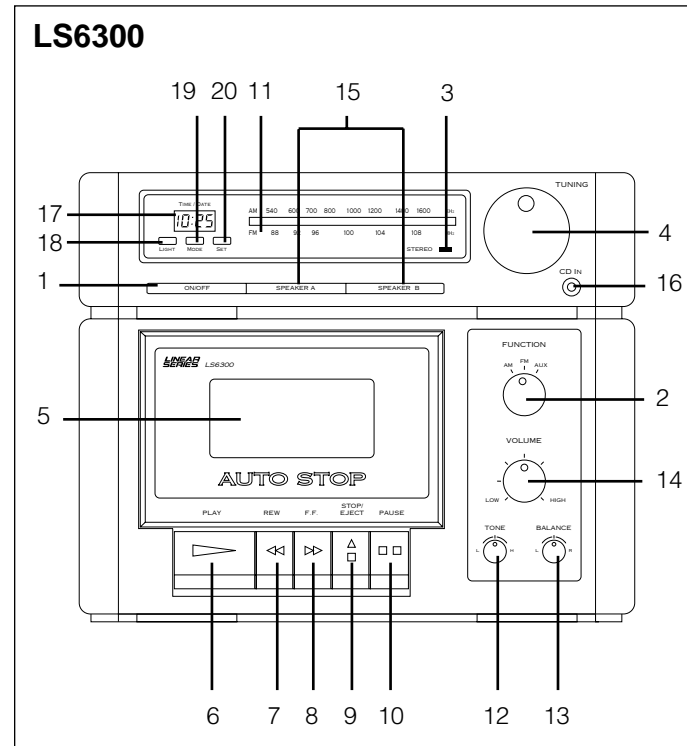
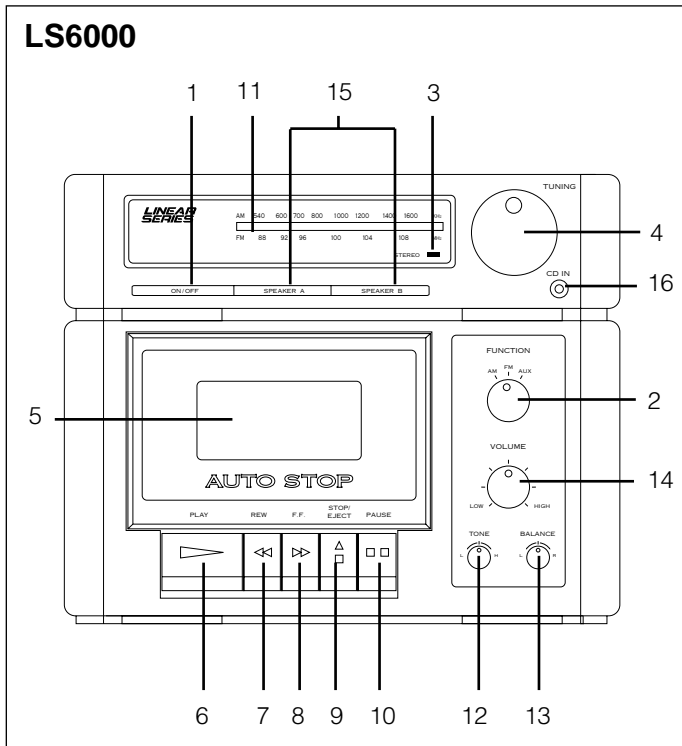

CONTROLS AND FUNCTIONS

1. On/Off Button

Press this button in to turn the unit on. Press again to turn the unit off.

2. AM/FM/AUX Function Knob

After turning the unit on, select the desired playing mode with this knob.

3. FM Stereo Indicator Light

When the tuner is receiving a strong stereo FM signal, the stereo light will be lit.

4. Radio Station Tuning Knob

Rotate this knob to locate the radio station that you desire. Rotating it clockwise will take you up the frequency band and rotating it counter-clockwise will take you down the frequency band.

5. Cassette Carriage Door

By pressing the cassette stop/eject button (9) the door will open to allow you to insert a tape.

6. Play Button

After inserting a cassette tape press this button to begin tape play.

7. Fast Rewind Button

To fast rewind the tape, press this button until it locks. To release the button press the stop/eject button.

8. Fast Forward Button

To fast forward the tape, press this button until it locks. To release the button press the stop/eject button.

9. Stop/Eject Button

When this button is pressed, tape play will stop and the cassette carriage door will open to allow you to remove the tape.

10. Pause Button

Pressing this button will stop the tape until the button is released.

11. Dial Indicator

The dial indicator will move up and down the scale as you rotate the tuning knob (4) indicating the station you are listening to.

12. Tone Control Knob

This control will tailor the overall tone of the unit. Rotate this control clockwise for a higher tone and counter-clockwise for a lower tone.

13. Balance Control Knob

Rotating this knob from left to right will allow you to balance the sound to suit your taste.

14. Volume Control Knob

Rotate this knob to increase the volume of the unit.

15. Speaker A/B Selector Buttons

To play the "A" set of speakers, press the "Speaker A" button. To play the "B" set of speakers, press the "Speaker B" button. To play the "A" and "B" speakers at the same time, press both buttons in.

CONTROLS AND FUNCTIONS

16. CD Input

Plug one end of a CD jumper cable into this receptacle and plug the other end into the "line out" receptacle or "headphone" receptacle of your portable CD player

It is strongly recommended to use the "line out" receptacle of the portable CD player. The LS6000 and LS6300's volume, balance and tone controls will operate normally when the CD input is used

17. Digital Display Clock (LS6300 Only)

This area displays the time. See the operations section of this manual for further information.

18. Clock Illumination Button (LS6300 Only)

Pressing this button will illuminate the digital display clock and will go off automatically when the button is not being pressed.

19. Clock Mode Button (LS6300 Only)

This button is used to set the clock, date, alarm and hour chime. See the operations section of this manual for further information.

20. Clock Set Button (LS6300 Only)

This button is used to adjust the time, day/date, alarm time and hour chime. See the operations section of this manual for further information.

Radio Operation

1. Press the on/off button (1) in to turn the unit on.
2. Use the function knob (2) to select the AM or FM radio band.
3. Tune in the desired radio station by rotating the tuning knob (4).
4. Adjust the volume, balance and tone controls as desired.

FM Stereo Operation

The unit will automatically switch from FM mono to FM stereo when the signal strength increases to a stereo level. If the signal should become weak on stereo reception, the unit will switch back to the mono mode.

Note: Stereo operation is indicated by the stereo light (3) on the front of the unit.

Tape Operation

1. Press the on/off button (1) to turn the unit on.
2. Press the stop/eject button (9) to open the cassette door.
3. Insert a cassette tape in the cassette carriage with the tape opening down and the programs you want to listen to facing you. Close the tape carriage door.
4. Press the play button (6).
5. To stop the tape play, press the eject button (9) once.
6. To release the tape carriage door and eject the tape, press the stop/eject button (9) again and the door will open.

Fast Forward and Fast Rewind

To fast forward or rewind a tape, press the fast forward button (▶▶) or the rewind button (◀◀) until it locks. To release the button, press the stop/eject button (■) once. To resume normal play, press the play button (▶).

AUX Operation

1. Set function knob (2) to the AUX position.
2. Turn on the item connected to the AUX inputs.
3. The volume, tone and balance controls will operate normally.

CONTROLS AND FUNCTIONS

How to Set the Date and Time (LS6300 Only)

1. With the normal time display showing, press the mode button 4 times. (The month will display)
2. Press the set button until the correct month appears.
3. Press the mode button again. (The day will display)
4. Press the set button until the correct day of the week is displayed.
5. Press the mode button. (The hours will be displayed)
6. Press the set button until the correct hour is displayed making sure to set AM or PM correctly. (This clock also has a 24 hour function) A=AM, P=PM and H=24 hour clock)
7. Press the mode button. (The minutes will be displayed)
8. Press the set button until the correct minutes are shown.
9. Press the mode button once more to return to a normal display.

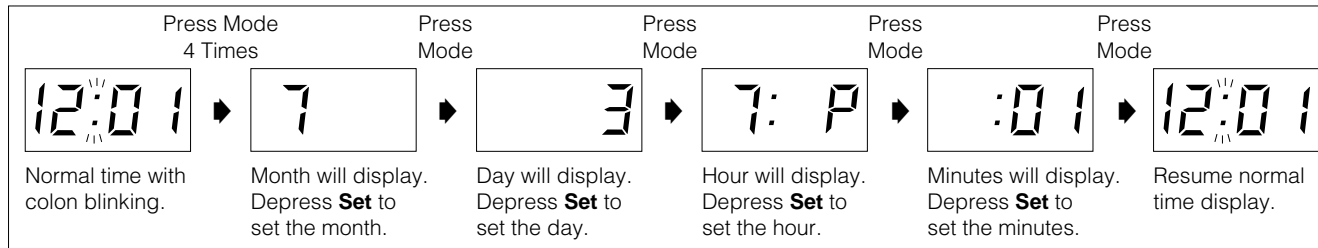

How to Set the Alarm (LS6300 Only)

1. With the normal time display showing, press the mode button. (The time will be blinking and "AL" will be displayed)
2. Press the mode button again. (The alarm hour will be blinking)
3. Press the set button to adjust the hour and AM, PM or H.
4. Press the mode button. (The minutes will be blinking)
5. Press the set button to adjust the minutes.
6. Press the mode button. (The display will return to normal time and "AL" will disappear from the display)

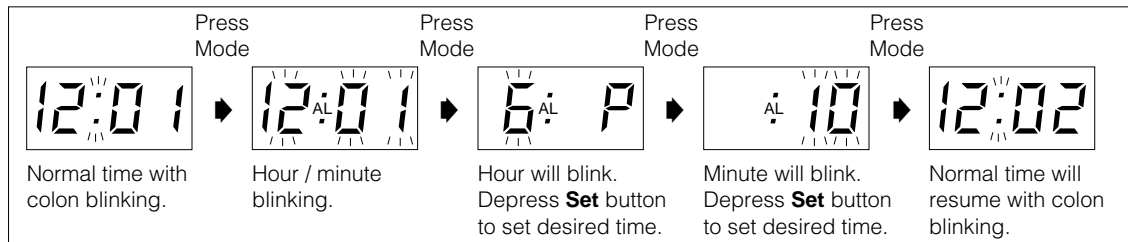

CONTROLS AND FUNCTIONS

How to Turn On/Off the Alarm Clock and Hour Chime (LS6300 Only)

1. With the normal time display showing, press the mode button. (The time display will begin to flash)
2. Press the set button. (The alarm on indicator will be displayed at the top the display area)
3. Press the set button again. (The hour chime indicator will be displayed at the button of the display area)
4. Press the set button again. (The alarm indicator will disappear and the alarm will be off)
5. Press the set button again. (The hour chime indicator will disappear and the hour chime will be off)

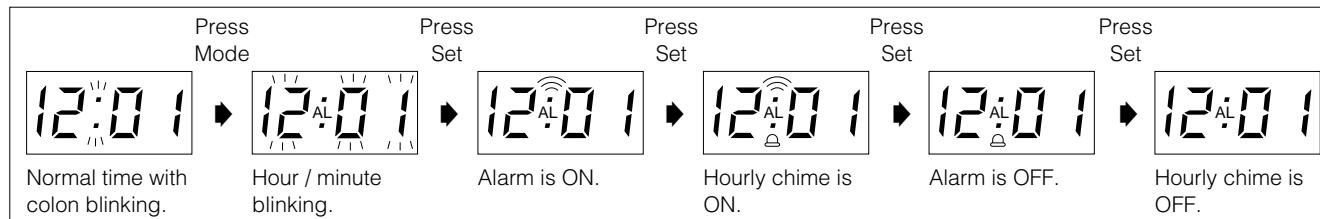

How to Quick Check All Settings: (LS6300 Only)

1. With the display showing the time, press the set button. (Alarm time will show)
2. Press the set button again. (Month and day will be displayed)
3. Press the set button again. (The seconds will be displayed)
4. Press the set button again. (Display will be normal time)

Note: In the alarm time and month/day modes, the display will change back to the normal time if the set button is not pushed within 2 seconds of these two display modes.

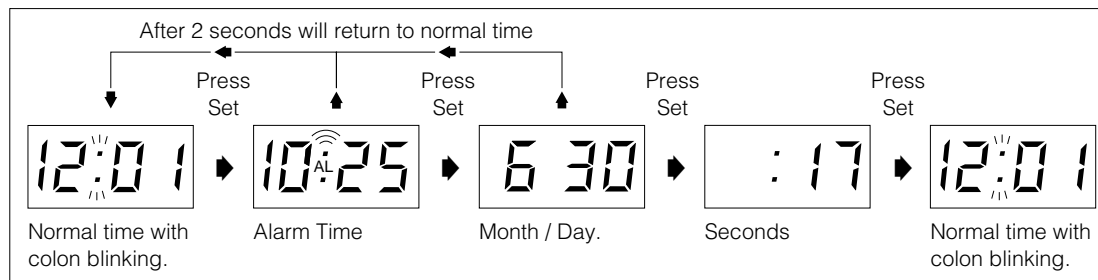

INSTALLATION

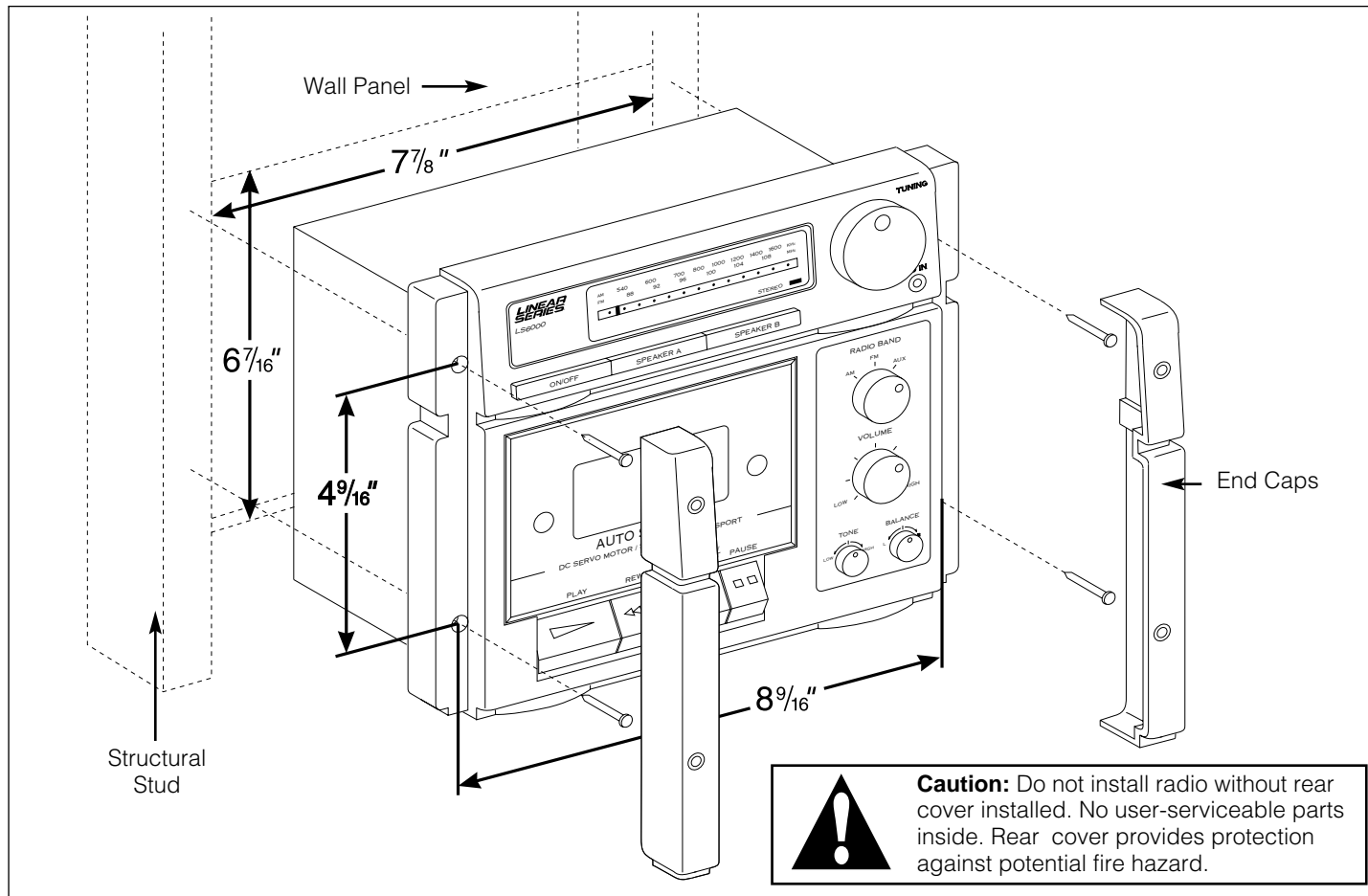

POWER / AUX CONNECTIONS

This unit for use only with a 12 volt DC power source with a negative ground.

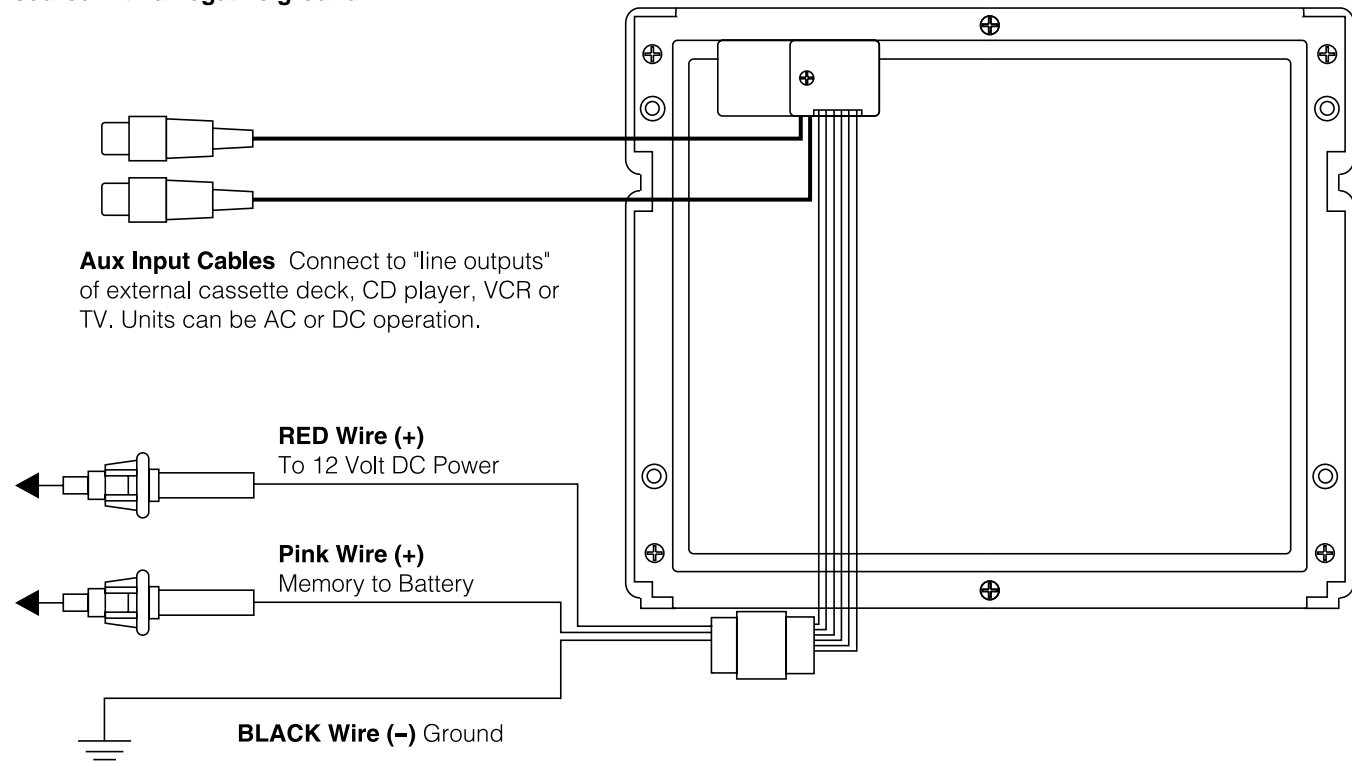

SPEAKER CONNECTIONS

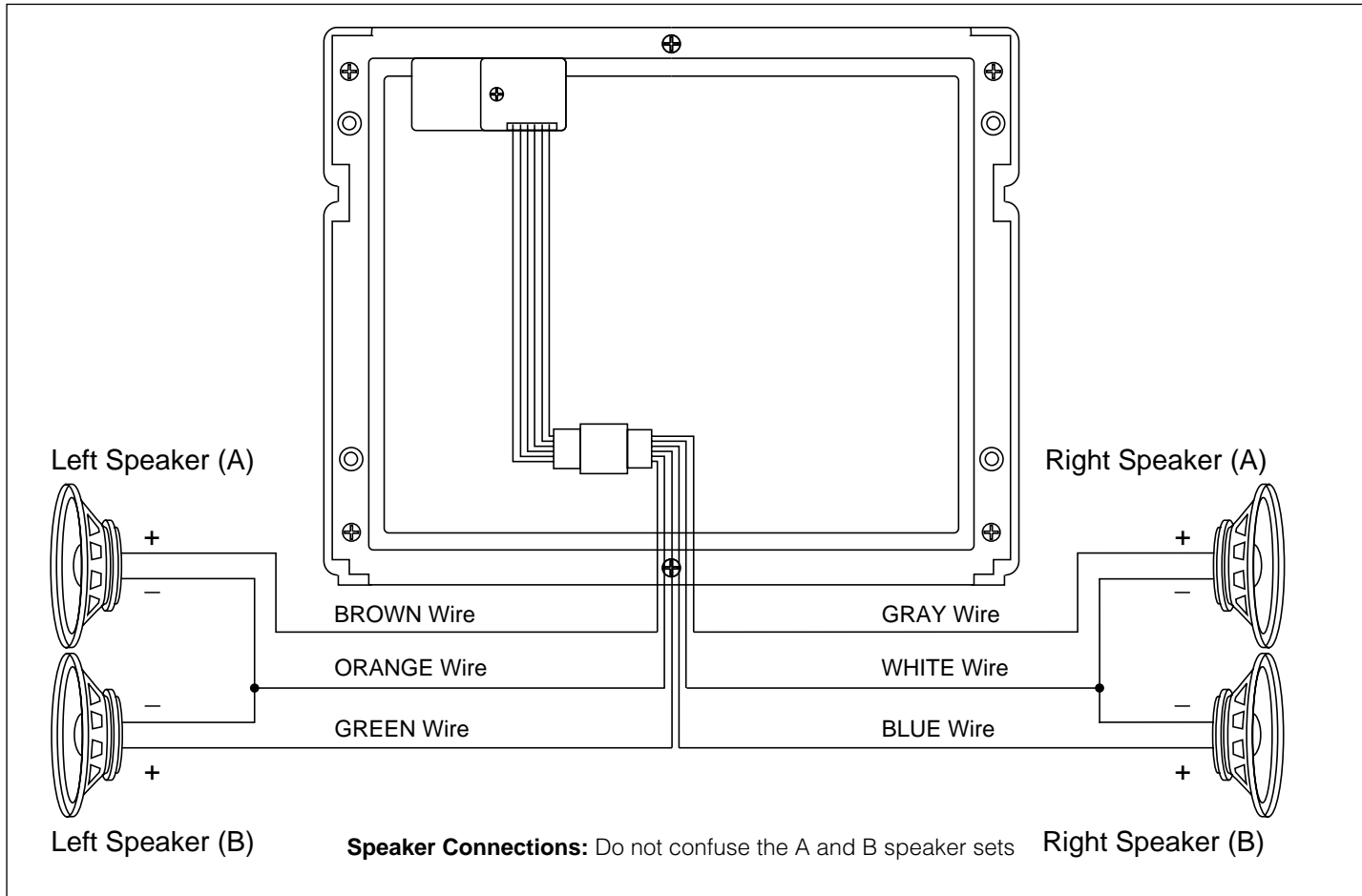

ANTENNA CONNECTIONS

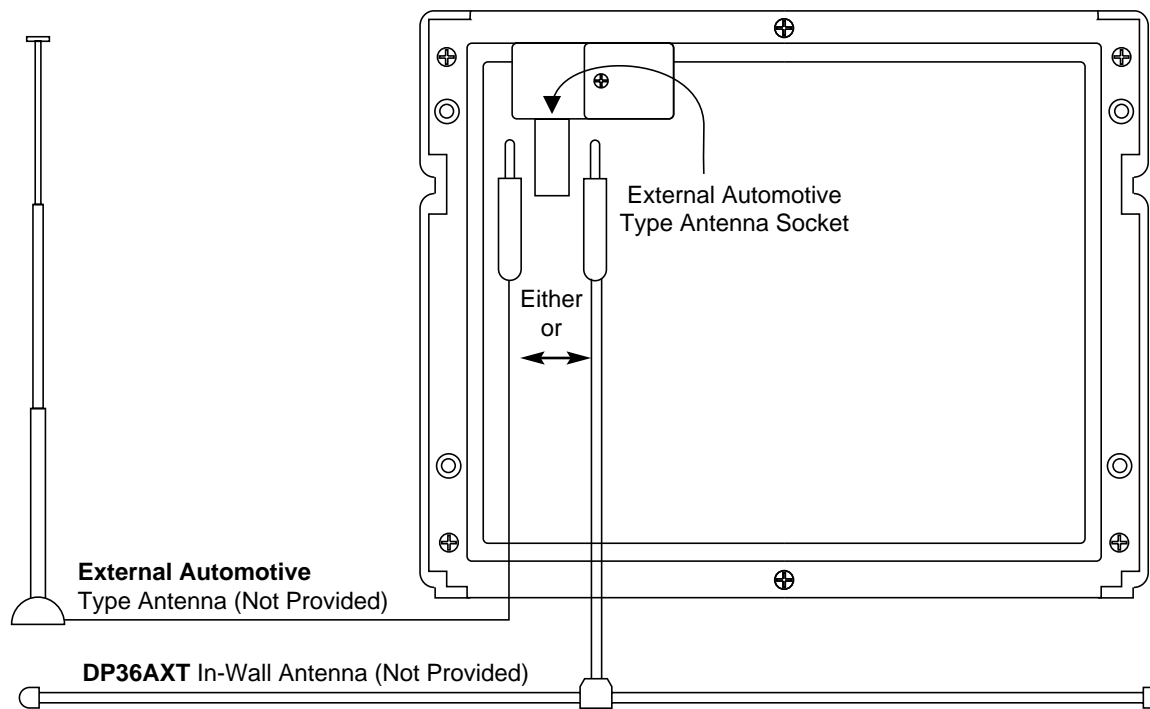

The LS6000 and LS6300 have a provision for a standard automotive antenna. If an automotive antenna is used, plug the male plug from the antenna into the female receptacle provided on the unit.

If an automotive antenna is not available or is undesired, we recommend the use of a Magnadyne DP36AXT di-pole antenna substitute. Plug the male plug from the DP36AXT into the female receptacle of the LS6000 or LS6300 unit and allow the cable of the antenna to lay inside the wall.

SAFETY INSTRUCTIONS

Read Instructions: All the safety and operating instructions should be read before the appliance is operated.

Retain Instructions: The safety and operating instructions should be retained for future reference.

Heed Warnings: All warnings on the appliance and in the operating instructions should be adhered to.

Follow Instructions: All operating and use instructions should be followed.

Water and Moisture: The appliance should not be used near water—for example, near a bathtub, washbowl, kitchen sink, laundry tub, in a wet basement, or near a swimming pool, etc.

Wall or Ceiling Mounting: The appliance should be mounted to a wall or ceiling only recommended by the manufacturer.

Heat: The appliance should be situated away from heat sources such as radiators, heat registers, stoves, or other appliances (including amplifiers) that produce heat.

Power Supply: The appliance should be connected to a power supply only of the type described in the operating instructions or as marked on the appliance.

Cleaning: The appliance should be cleaned only as recommended by the manufacturer.

Power Lines: An outdoor antenna should be located away from power lines.

Outdoor Antenna Grounding: If an outside antenna is connected to the receiver, be sure the antenna system is grounded so as to provide some protection against voltage surges and built up static charges. Section 810 of the National Electrical Code, ANSI/NFPA no. 70-1983, provides information with respect to proper grounding of the mast and supporting structure, grounding of the lead-in wire to an antenna discharge unit, size of grounding conductors, location of antenna-discharge unit, connection to grounding electrodes, and requirements for the grounding electrode. See figure 1.

Object and Liquid Entry: Care should be taken so that objects do not fall and liquids are not spilled into the enclosure through openings.

Damage Requiring Service: The appliance should be serviced by qualified service personnel when:

- A. The power supply cord or the plug has been damaged; or
- B. Objects have fallen, or liquid has spilled into the appliance; or
- C. The appliance has been exposed to rain; or
- D. The appliance does not appear to operate normally or exhibits a marked change in performance; or
- E. The appliance has been dropped, or the enclosure damaged.

Servicing: The user should not attempt to service the appliance beyond that described in the operating instructions. All other servicing should be referred to qualified service personnel.

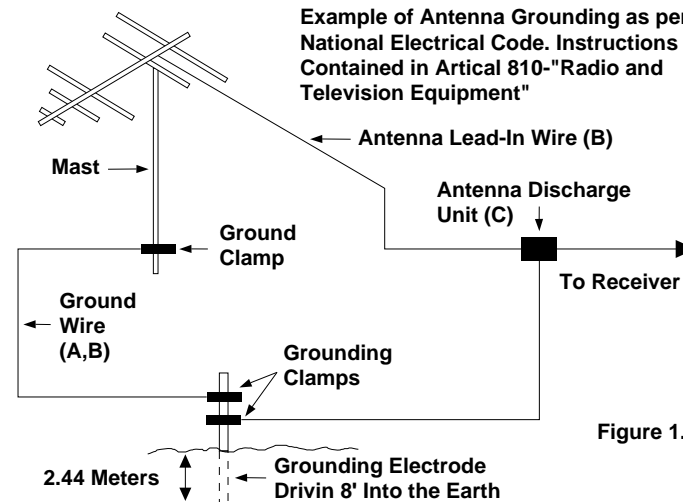

- A)** Use No. 10 AWG (5.3mm²) copper, No 8 AWG (8.4mm²) aluminum, No. 17 AWG (1.0mm²) copper clad steel or bronze wire, or larger, as ground wire.
- B)** Secure antenna lead-in and ground wires to house with stand-off insulators spaced from 4 feet (1.22m) to 6 feet (1.83m) apart.
- C)** Mount antenna discharge unit as close as possible to where lead-in enters house.

OPERATION AND MAINTENANCE

Maintenance

The playback head is a very important part of the tape playback system. If it becomes dirty, the sound quality will deteriorate resulting in loss of fidelity (high frequency reproduction). The head should be cleaned every 20 hours of use. (Approximately)

1. Press the eject button and open the cassette door.
2. Clean the playback head with a cotton applicator (Q-tip) and alcohol. Soak the cotton applicator in the alcohol and rub the face of the head until it is clean. Never use sharp objects to perform cleaning.

Caution:

Cassette tape should be stored in a container or vinyl bag to prevent contamination by moisture and dust. Tapes should not be placed in locations exposed to sunlight or in the vicinity of any magnetic field such as televisions or stereo speakers.

Be sure and eject the tape before turning off the unit. If a cassette is left engaged in the mechanism, a flat spot will develop from the pressure of the capstan and pinch roller, thus causing uneven sound reproduction and damage to your tapes.

Before inserting a cassette into the unit, look through the cassette window to make sure that there is no excess slack, several loose turns. If necessary, insert a pencil or similar object in the reel hub (figure A) and rotate it to take up the

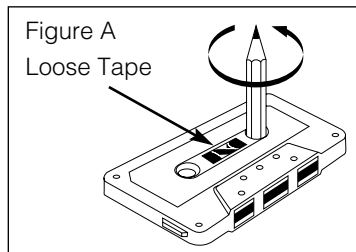

slack. If a poor quality tape or a 120 minute tape is used in this unit the tape may become entangled with the capstan and break. We recommend no longer than 90 minute, good quality brand name cassettes be used in the LS6000/LS6300.

WARRANTY

ONE (1) YEAR LIMITED WARRANTY

Magnadyne Corporation or its authorized agents will within 1 year from the date of sale to you, repair, replace or refund the retail sales price of said product or any part thereof, at the option of the Magnadyne Corporation or its authorized agents, if said product or part is found defective in materials or workmanship, when properly connected and operating on the correct power requirements designated for the specific product. This warranty and Magnadyne Corporation or its authorized agents obligations hereunder do not apply where the product was; damaged while in the possession of the consumer, subjected to unreasonable or unintended use, not reasonably maintained, utilized in commercial or industrial operations, or serviced by anyone other than Magnadyne Corporation or its authorized agents, or where the warning seal on the product is broken or the power and/or plugs are detached from the unit. Magnadyne Corporation or any of its authorized agents will not assume any labor costs for the removal and re-installation of any product found to be defective, or the cost of transportation to Magnadyne Corporation or its authorized agents. Such costs are the sole responsibility of the purchaser.

This warranty does not cover the cabinet appearance items or accessories used in connection with this product, or any damaged to recording or recording tape, or any damage to the to the products resulting from improper installation, alteration, accident, misuse, abuse or acts of nature.

MAGNADYNE CORPORATION OR ITS AUTHORIZED AGENTS SHALL NOT BE LIABLE TO ANYONE FOR CONSEQUENTIAL OR INCIDENTAL DAMAGES OR CLAIMS EXCEPT THOSE ACCORDED BY LAW. NO EXPRESSED WARRANTY OR IMPLIED WARRANTY IS GIVEN EXCEPT THOSE SET FORTH HEREIN. NO IMPLIED WARRANTY SHALL EXTEND BEYOND 1 YEAR FROM THE DATE OF SALE.

This warranty extends only to the original purchaser of the product and is not transferable.

Some states do not allow limitations on how long an implied warranty lasts, and some states do not allow the exclusion or limitation of incidental or consequential damages, so the above limitations or exclusion may not apply to you. This warranty gives you specific legal rights, and you may have other rights that vary from state to state.

Defective merchandise should be returned to the original point of purchase or secondly, to Magnadyne Corporation, 1111 W. Victoria Street, Compton CA 90220, or 2061 Cohen Street, Montreal, Quebec H4R 2N7. Return Authorization must be obtained before sending, or merchandise may be refused.