

KENWOOD

KRC-459R

CASSETTE RECEIVER
INSTRUCTION MANUAL

KENWOOD CORPORATION

© B64-1113-00 (EW)

Contents

<i>Before use</i>	
Safety precautions	3
<i>Buttons and Display</i>	
Basic operations	5
Tuner features	5
RDS features	6
Cassette player features	6
Disc changer control features	7
Other features	7
Remote control	8
<i>Basic operations</i>	
Power	8
Volume	8
Attenuator	8
Menu System	9
Loudness	10
<i>Basic operations of remote control (Optional)</i>	10
<i>Tuner features</i>	
Selecting Tuning Mode	12
Tuning	12
Local Seek Function	12
Monaural Reception	12
Station Preset Memory	13
Auto Memory Entry	13
Direct Access Tuning	13
<i>RDS features</i>	
RDS (Radio Data System)	14
EON (Enhanced Other Network)	14
Alarm	14
AF (Alternative Frequency) Function	14
Restricting RDS Region (Region Restrict Function)	14
Traffic Information Function	15
Presetting Volume for Traffic Information/News	15
News Bulletin Function	16
Auto TP Seek Function	16
Programme Type (PTY) Function	17
<i>Cassette player features</i>	
Playing Cassette Tapes	18
Fast Forwarding and Rewinding Cassette Tapes	18
Tuner Call Function	18
Tape Advance Function	18
Blank Skip Function	19
Music Repeat Function	19
<i>Disc changer control features</i>	
Playing Discs Using Disc Changer	19
Switching Display for Discs	19
Fast Forwarding and Reversing Disc Play	20
Track Search	20
Disc Search	20
Direct Track Search	20
Direct Disc Search	21
Track / Disc Repeat Function	21
Track Scan Function	21
Disc Scan Function	22
Random Play Function	22
Magazine Random Play Function	22
Presetting Disc Names	23
<i>Other features</i>	
Audio Control Setting	24
Clock Display	24
Adjusting Time	24
TEL Mute Function	24
Selectable Illumination	25
DSI (Disabled System Indicator)	25
Theft Deterrent Faceplate	25
<i>Installation</i>	
Accessories	26
Installation Procedure	26
Connecting Cables to Terminals	27
Installation	28
<i>Troubleshooting guide</i>	30
<i>Specifications</i>	33

Safety precautions

⚠WARNING

To prevent injury and/or fire, take the following precautions:

- Insert the unit all the way until it is fully locked in place. Otherwise it may fly out of place during collisions and other jolts.
- When extending the ignition, battery or ground cables, make sure to use automotive-grade cables or other cables with an area of 0.75mm² (AWG18) or more to prevent cable deterioration and damage to the cable coating.
- To prevent short circuits, never put or leave any metallic objects (e.g., coins or metal tools) inside the unit.
- If the unit starts to emit smoke or strange smells, turn off the power immediately and consult your Kenwood dealer.
- Be careful not to drop the unit or subject it to strong shock. The unit may break or crack because it contains glass parts.
- Do not touch the liquid crystal fluid if the LCD is damaged or broken due to shock. The liquid crystal fluid may be dangerous to your health or even fatal. If the liquid crystal fluid from the LCD contacts your body or clothing, wash it off with soap immediately.

⚠CAUTION

To prevent damage to the machine, take the following precautions:

- Make sure to ground the unit to a negative 12V DC power supply.
- Do not open the top or bottom covers of the unit.
- Do not install the unit in a spot exposed to direct sunlight or excessive heat or humidity. Also avoid places with too much dust or the possibility of water splashing.
- Do not set the removed faceplate or the faceplate case in areas exposed to direct sunlight, excessive heat or humidity. Also avoid places with too much dust or the possibility of water splashing.
- Do not subject the faceplate to excessive shock, as it is a piece of precision equipment.
- To prevent deterioration, do not touch the terminals of the unit or faceplate with your fingers.
- When replacing a fuse, only use a new one with the prescribed rating. Using a fuse with the wrong rating may cause your unit to malfunction.
- To prevent short circuits when replacing a fuse, first disconnect the wiring harness.
- During installation, do not use any screws except for the ones provided. The use of improper screws might result in damage to the main unit.

IMPORTANT INFORMATION

You cannot connect the unit directly to the following CD automatic changers. For users who want to use older changers with the unit, follow the directions below according to the type of changer you own:

• KDC-C200 / KDC-C300 / KDC-C400

Use the extension cable and the control box attached to the CD changer, and the optional CA-DS100 converter cable.

• KDC-C301 / KDC-C600 / KDC-C800 / KDC-C601 / KDC-C401

Use the extension cable attached to the CD changer, and the optional CA-DS100 converter cable.

• KDC-C100 / KDC-C302 / C205 / C705 / non-Kenwood CD changers

Cannot be used with this model.

⚠CAUTION

You can damage both your unit and the CD changer if you connect them incorrectly.

Safety precautions

NOTE

- If you experience problems during installation, consult your Kenwood dealer.
- If the unit does not seem to be working right, try pressing the reset button first. If that does not solve the problem, consult your Kenwood dealer.

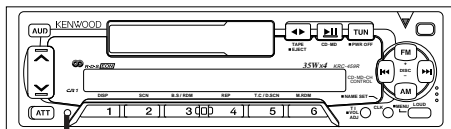

Reset button

Cleaning the Unit

If the front panel gets dirty, turn off the power and wipe the panel with a dry silicon cloth or soft cloth.

CAUTION

Do not wipe the panel with a stiff cloth or a cloth dampened by volatile solvents such as paint thinner and alcohol. They can scratch the surface of the panel and/or cause the indicator letters to peel off.

Cleaning the Faceplate Terminals

If the terminals on the unit or faceplate get dirty, wipe them with a dry, soft cloth.

Cleaning the Tape Head

After you have used the tape player many times over a long period, magnetic powder from the tapes and dust accumulates on the tape head, causing noise and a deterioration in sound quality. Clean the tape head using a cleaning tape or cleaning kit designed for use in car audio systems.

Handling Cassette Tapes

- Do not play a cassette whose tape has gone slack. In such a case, wind it tight using a pencil or the like in one of the spools. Playing slack cassette tapes can result in the tape tangling around the capstan and/or pinch rollers, causing trouble.
- Do not play a deformed cassette or one whose label is starting to come off, as it can cause the unit to malfunction.
- Do not leave tapes in hot places, such as above the fascia panel (dashboard) and other spots exposed to direct sunlight, or near heater outlets. They can deform the cassette.
- Avoid using extremely long cassette tapes, such as 100-minute-long tapes. Such tapes are very thin, and can tangle easily around the pinch rollers or other parts inside the unit, causing unit failure.
- Remove a cassette tape from the unit when not listening to it for a whilst. If you leave a tape in the unit too long, it may stick to the tape head and cause unit malfunction.

Buttons and Display

Basic operations

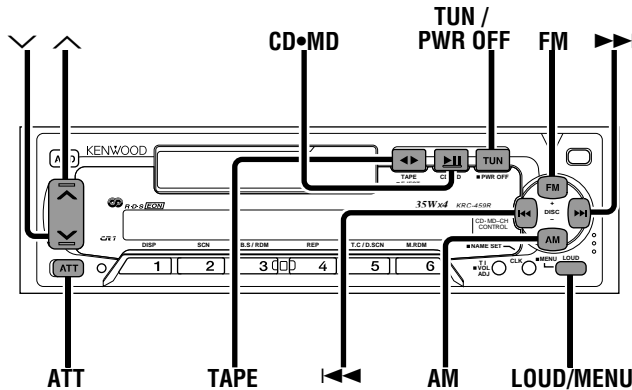

Tuner features

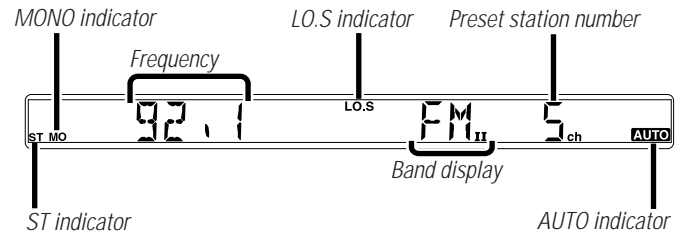
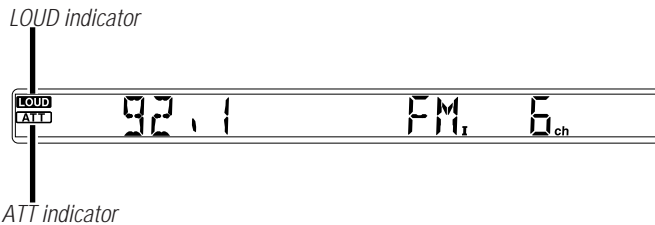
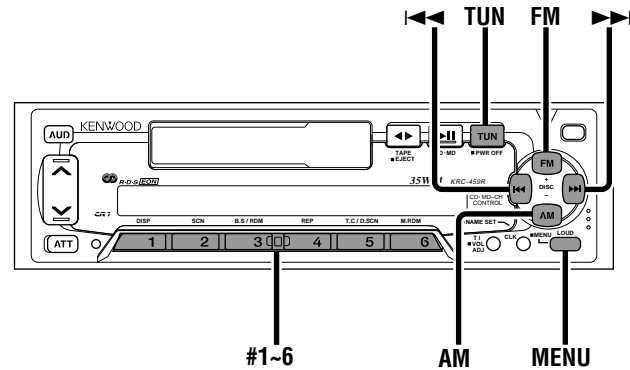

Buttons and Display

RDS features

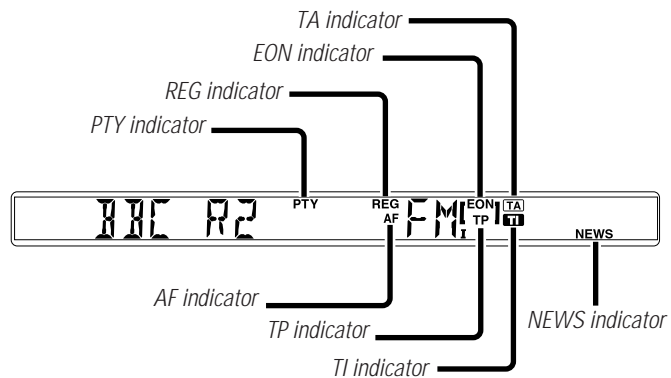
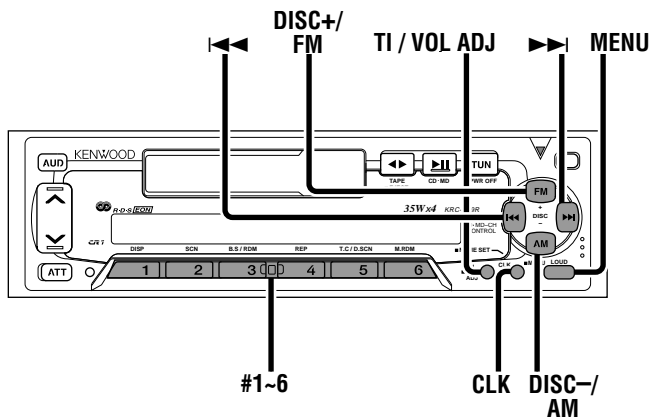

Cassette player features

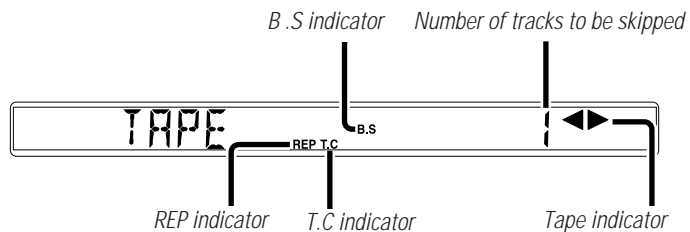
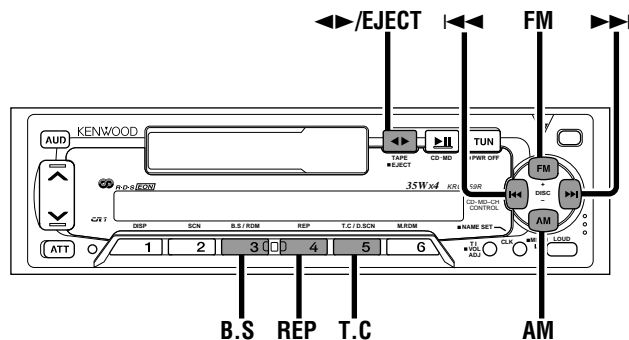

Disc changer control features

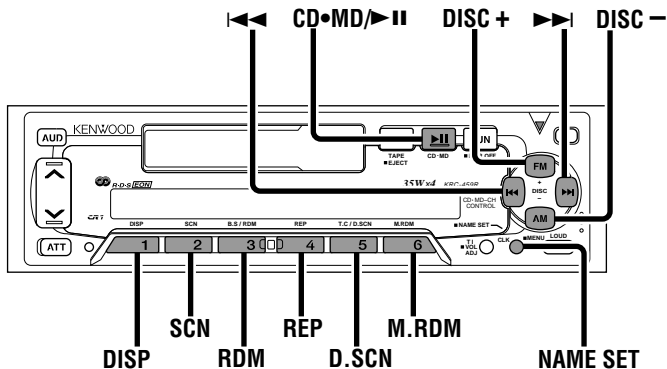

Other features

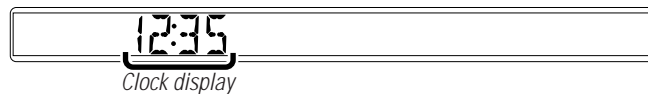
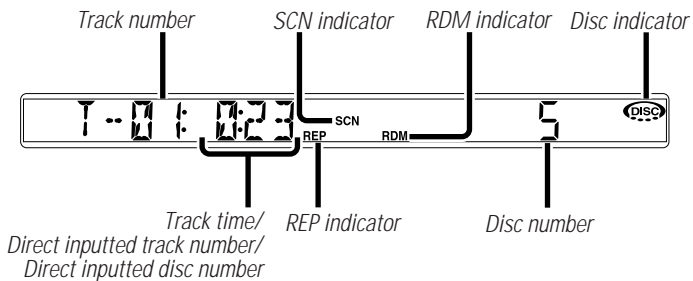
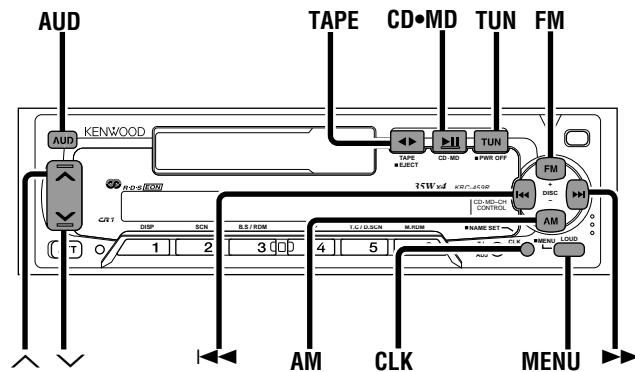

Buttons and Display

Remote control

Optional

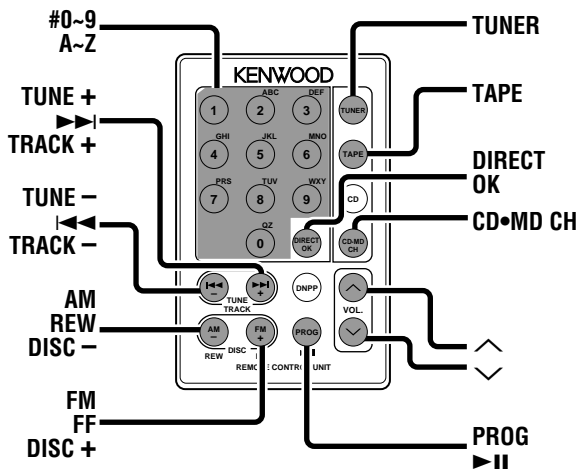

Basic operations *(See page 5)*

Power

Turning on the power:

Press one of the following buttons: TAPE, CD•MD, or TUN.

NOTE

Turn the power on before completing the following procedures.

Turning off the power:

Hold down the PWR OFF button for one second or more.

Selecting the standby mode:

Press the TUN button repeatedly to select "ALL OFF". When "ALL OFF" is displayed, the standby mode is turned on. The standby mode turns all functions off although leaving the unit's power on. Use this mode when you want to have the display illuminated but do not want to listen to anything.

NOTE

The AF function can be turned on or off even when the standby mode has been turned on. If the power is on, the AF function tunes in to stations that offer good reception.

Volume

Increasing Volume:

Press the \wedge button to turn up the volume.

Decreasing Volume:

Press the \vee button to turn down the volume.

Attenuator

This function allows you to turn down the volume quickly.

Turning Attenuator On/Off:

Press the ATT button to switch the attenuator on and off. When the attenuator is on, the ATT indicator blinks. When the attenuator is off, the volume returns to the original level.

NOTE

Turning down the volume all the way turns off the attenuator function.

Menu System

To accommodate a greater number of functions, a menu system has been employed for making settings. Press the MENU button to enter the menu mode and then display the function to make the setting. Details on each setting are explained separately in the corresponding function page.

- Hold down the MENU button for one second or more. "MENU" is displayed when the menu mode is entered. The function that you can adjust is indicated with the current settings displayed.
- Selecting function to set**
Press the ►► button to search through the functions until you see the one you want to adjust in the display. Press the ◀◀ button to search through the functions backward.
Example: If you want to switch the tuning mode from manual to automatic, first search through the functions until you see "MANUAL" in the display.

MANUAL

3 Changing setting for currently displayed function

Press either the AM or FM button. The setting will change for each function.
Example: The tuning mode will switch from manual to automatic, and "AUTO" is displayed.

MANUAL

→
AUTO

With the programme type function and the auto memory function, the function will start to activate.

NOTE

To use the auto memory function, hold down either the AM or FM button for two seconds or more.

Function	Varieties of settings for each function (display)
Disabled System Indicator	DSI ON ↔ DSI OFF ↑↓
Selectable Illumination	COL GRN ↔ COL AMB ↑↓
News Bulletin Function	NEWS 00M ↔ NEWS OFF ↑↓
Local seek	LO.S ON ↔ LO.S OFF ↑↓
Selecting Tuning Mode	AUTO ↔ MANUAL ↑↓
Auto Memory Entry	A-MEMORY (start) ↑↓
*AF Function	AF ON ↔ AF OFF ↑↓
*Region Restrict Function	REG ON ↔ REG OFF ↑↓
*Auto TP Seek	ATPS ON ↔ ATPS OFF ↑↓
*Monaural Reception	MONO ON ↔ MONO OFF ↑↓
*Programme Type	PTY (PTY mode entered) ↑

4 Ending the menu mode

Press the MENU button.

NOTE

- Make sure to end the menu mode when finished. If you fail to end the menu mode, several functions may not operate properly, including the Traffic Information function, the News Bulletin function with PTY news timeout setting, and the Alarm function.
- Some tuner functions will not be displayed unless you are currently listening to the tuner.
- Functions marked with an asterisk (*) cannot be used during AM reception.
- The News function turns on when the setting is made for the news interruption interval. The "00M" display indicates the setting selected for the news interruption timeout interval.

Basic operations (See page 5)

Loudness

This function amplifies low and high tones when the volume is turned down.

The **LOUD** indicator lights up, when the loudness function is on.

Turning Loudness On/Off:

Press the **LOUD** button to switch the loudness on and off.

Basic operations of remote control (See page 8) Optional

▲CAUTION

Do not set the remote control on hot places such as above the fascia panel (dashboard).

Replacing the Lithium Battery:

Use one lithium battery (CR2025).

Remove the case following the instructions as illustrated.

To open

- ① Keep on slide
- ② Pull out.

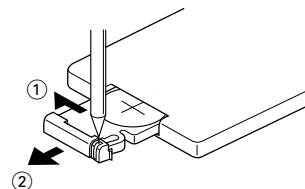

Insert the battery with the + and – poles aligned properly, following the illustration inside the case.

▲WARNING

Store unused lithium batteries out of the reach of children.

Contact a doctor immediately if the battery is accidentally swallowed.

All Modes

- **VOL. buttons**
Keep on pressing the \wedge button to turn the volume up.
Keep on pressing the \vee button to turn the volume down.
- **TUNER button**
Selects the tuner mode. Pressing this button again selects the standby mode.
- **TAPE button**
Selects the tape mode.
- **CD•MD CH button**
Selects the disc changer mode.

Tuner Mode

- **Numeric buttons**
Press buttons #1-6 to recall preset stations.
During direct access tuning, use these buttons to input the frequency of the station.
- **TUNE buttons**
Press the TUNE- button to decrease the frequency.
Press the TUNE+ button to increase the frequency.
- **AM/FM button**
Press the AM button to select the MW and LW bands.
Press the FM button to select and switch between FM1, FM2, and FM3 bands.
- **DIRECT button**
Selects the direct access tuning mode, used to input frequencies directly. Press this button again to cancel the mode whilst it is operating.

Tape Mode

- **T.ADV (◀◀/▶▶) buttons**
Press the ◀◀ button to start play again at the beginning of the current track.
Press the ▶▶ button to start play at the beginning of the next track.
- **REW button**
Rewinds the tape.
- **FF button**
Fast forwards the tape.
- **PROG button**
Plays the reverse side of the tape. When pressed during fast forwards and rewinds, this button stops the tape and starts playing it.

Disc Changer Mode

- **Number/ letter entry buttons**
Used to specify the track (disc) number used in direct track (disc) searches.
Used to enter letters during disc name preset.
- **TRACK buttons**
Press the TRACK- button to search through the tracks backwards.
Press the TRACK+ button to search through the tracks forwards.
Used to move the cursor whilst entering disc name.
- **DISC buttons**
Press the DISC- button to search through the discs backwards.
Press the DISC+ button to search through the discs forwards.
Selects numbers and symbols whilst entering disc name.
- **▶|| button**
When a disc is playing, this button pauses the play.
Press the same button again to start play again.
- **OK button**
Stores letters that have been entered during disc name input and ends enter mode.

Tuner features *(See page 5)*

Selecting Tuning Mode

Select which tuning mode — auto seek or manual — to use as the default.

When the AUTO indicator is on, auto seek tuning is selected.

When the indicator is off, manual tuning is selected.

- 1 Hold down the MENU button for one second or more. "MENU" is displayed and the menu mode is turned on.
- 2 Press the ►► button repeatedly until the tuning function appears in the display.
Press the ◀◀ button to search in the other direction.
The function setting is indicated by "AUTO" or "MANUAL" in the display, indicating auto seek or manual tuning, respectively.

3 Switching settings

Press either the AM button or FM button to switch the tuning mode.

The display and setting will change.

- 4 Press the MENU button to end the menu mode.

Tuning

- 1 Press the TUN button to turn the radio on.
- 2 Press either the FM or AM button to select the band.
Each time you press the FM button, the band switches between the FM1, FM2 and FM3.
Press the AM button to select the MW and LW bands.
- 3 • Auto Seek Tuning
Press the ►► button to seek increasing frequencies.
Press the ◀◀ button to seek decreasing frequencies.
• Manual Tuning
Press the ►► button to increase the frequency by one step.
Press the ◀◀ button to decrease the frequency by one step.

NOTE

The ST indicator lights up when stereo broadcasts are being received.

Local Seek Function

With the local seek function turned on, auto seek tuning skips stations with relatively poor reception.

Turning Local Seek Function On/Off:

- 1 Hold down the MENU button for one second or more. "MENU" is displayed and the menu mode is turned on.
- 2 Press the ►► button repeatedly until the local seek function appears in the display.
Press the ◀◀ button to search in the other direction.
The function setting is indicated by "LO.S ON" or "LO.S OFF" in the display, indicating that the local seek function is on or off, respectively.
- 3 **Switching settings**
Press either the AM button or FM button.
The display and setting will change.
When local seek function is on, the LO.S indicator is turned on.
- 4 Press the MENU button to end the menu mode.

Monaural Reception

When poor stereo reception is experienced, this function will reduce noise and improve listening conditions.

- 1 Hold down the MENU button for one second or more. "MENU" is displayed and the menu mode is turned on.
- 2 Press the ►► button repeatedly until the monaural reception function appears in the display.
Press the ◀◀ button to search in the other direction.
The function setting is indicated by "MONO ON" or "MONO OFF" in the display, indicating that monaural reception is on or off, respectively.
- 3 **Switching settings**
Press either the AM button or FM button.
The display and setting will change.
When monaural reception is on, the MONO indicator turns on.
- 4 Press the MENU button to end the menu mode.

Station Preset Memory

Store the frequency of the station currently being listened to. You can then recall that station with a single touch of a button.

- 1 Select the band/ station that you want to have stored.
- 2 Hold down the button (#1-6) that you want to use for the station, for two seconds or more.
The button number blinks once in the display to indicate that the data has been stored.

Recalling a Preset Station:

Press the preset station button (#1-6) for the desired station. The number of the recalled station is displayed.

NOTE

You can store 6 stations in each of the FM1, FM2, FM3, and AM (MW and LW) bands.

Auto Memory Entry

You can automatically store all the receivable frequencies in the band currently being listened to, and then recall them with the touch of a button later. This function is especially useful when you are travelling and do not know what stations are available. Up to 6 frequencies can be stored this way.

- 1 Select the band for auto memory entry.
- 2 Hold down the MENU button for one second or more. "MENU" is displayed and the menu mode is turned on.
- 3 Press the ►► button repeatedly until "A-MEMORY" appears in the display.
Press the ◀◀ button to search in the other direction.
- 4 Hold down either the AM button or FM button for two seconds or more to start auto memory function.
The numbers of the preset station buttons showed in order. When all the stations in a certain band are stored in the preset memory, the auto memory entry stops. The tuner then plays the last station received.

Recalling a Preset Station:

Press the preset station button (#1-6) for the desired station. The number of the recalled station is displayed.

NOTE

- When the AF function is turned on whilst auto memory entry takes place, only RDS stations (i.e., stations with RDS capability) are stored. RDS stations that have been preset for FM1 cannot also be preset in FM2 or FM3.
- When the local seek function is turned whilst auto memory entry takes place, stations with poor reception are not stored.
- When the Traffic Information function is on, only the local traffic information station frequency will be stored.

Cancelling Auto Memory Entry During Its Operation:

Press the MENU button whilst auto memory entry is taking place to stop the process.

Function of remote control (See page 8)

Direct Access Tuning

When you already know the frequency of the station that you want to listen to, you can enter it directly for quick access. (Function of remote control)

- 1 Select the band by pressing the FM or AM button.
- 2 Press the DIRECT button.
In the display, "----" blinks for 10 seconds.
If you make no input in the 10-second period, direct access tuning is automatically cancelled.
- 3 Enter the frequency of the desired station whilst the display is blinking.
If you want to listen to an FM station at 92.1 MHz, for example, press 0, 9, 2, and 1.
If you want to listen to an AM station at 810 kHz, for example, press 0, 8, 1, and 0.

NOTE

- When a frequency which cannot be received is input, this frequency is not verified and operation returns to the original frequency input mode.
- FM frequencies can only be input in 0.1 MHz steps.

Cancelling Direct Access Tuning:

Press the DIRECT button again.

RDS features (See page 6)

RDS (Radio Data System)

RDS is a digital information system that lets you receive signals besides those of regular radio programmes, such as network information being transmitted from radio stations. When listening to an RDS station (ie, a station with RDS capability), the programme service name of the station is displayed along with the frequency, advising you quickly which station is being received.

RDS (Radio Data System) stations also transmit frequency data for the same station. When you are making long trips, this function automatically switches to the particular frequency with the best reception for the particular network of stations that you want to listen to. The data is automatically stored, allowing you to switch quickly to another RDS stations, broadcasting the same programme, that has better reception. These include stations stored in the station preset memory that you often listen to.

EON (Enhanced Other Network)

Stations that offer EON also transmit information about other RDS stations that have traffic information. When you are tuned to a station that is not transmitting traffic information, but another RDS station starts transmitting a traffic bulletin, the tuner automatically switches to the other station for the duration of the bulletin.

The EON indicator lights up when the RDS station currently being listened to starts to broadcast EON frequency data.

Alarm

When an emergency transmission (announcing disasters, etc.) is sent, all current functions are interrupted to allow the warning to be received.

AF (Alternative Frequency) Function

When poor reception is experienced, automatically switch to another frequency broadcasting the same programme in the same RDS network with better reception. The AF indicator lights up when the AF function is turned on.

Turning AF Function On/Off:

- 1 Hold down the MENU button for one second or more. "MENU" is displayed and the menu mode is turned on.
- 2 Press the ►► button repeatedly until the AF function appears in the display. Press the ◀◀ button to search in the other direction. The function setting is indicated by "AF ON" or "AF OFF" in the display, indicating that the AF function is on or off, respectively.
- 3 **Switching settings**
Press either the AM button or FM button. The display and setting will change.
- 4 Press the MENU button to end the menu mode.

Displaying Frequencies:

Hold down the CLK button for one second or more. The frequency for the RDS station will be displayed for five seconds instead of the station name.

NOTE

When no other stations with stronger reception are available for the same programme in the RDS network, you may hear the incoming broadcast in bits and snatches. Turn off the AF function in such a case.

Restricting RDS Region (Region Restrict Function)

You can choose whether or not to restrict the RDS channels, received with the AF function for a particular network, to a specific region. When the Region Restrict Function is on, the region is restricted and the REG indicator is turned on.

Turning Region Restrict Function On/Off:

- 1 Hold down the MENU button for one second or more. "MENU" is displayed and the menu mode is turned on.
- 2 Press the ►►► button repeatedly until the Region restrict function appears in the display.
Press the ◀◀◀ button to search in the other direction. The function setting is indicated by "REG ON" or "REG OFF" in the display, indicating that the function is on or off, respectively.
- 3 **Switching settings**
Press either the AM button or FM button.
The display and setting will change.
- 4 Press the MENU button to end the menu mode.

NOTE

Sometimes stations in the same network broadcast different programmes or use different programme service names.

Traffic Information Function

You can listen to traffic information. If you are listening to tapes or discs, they will continue playing until a traffic bulletin is broadcast.

Turning TI function On/Off:

Press the TI button to turn the function on and off.
When the function is on, the TI indicator is turned on.
When a traffic information station is being received, the TP indicator will turn on. When none is being received, the TI indicator will blink on and off.
When a traffic bulletin begins to be broadcast, the TA indicator will turn on, and reception will begin at the preset volume.
If you are listening to a tape or disc when a traffic bulletin begins, they will automatically be turned off. When the bulletin ends or poor reception is experienced, the tape or disc will begin playing again.

NOTE

Pressing the TI button whilst in the MW/LW band automatically switches reception to the FM band. However, the MW/LW band is not returned to when the TI button is pressed again.

Switching to a Different Traffic Information Station:

Use the ◀◀◀ / ►►► buttons to make an auto seek of the TI stations in a certain band.

NOTE

- When you are listening to a tape or disc, you cannot change to another TI station.
- When the auto TP seek function is turned on and reception starts to weaken, the tuner automatically seeks stations with better reception.
- If you are tuned to a station that is not a traffic information station itself but which provides EON services, you can still have traffic information received. The EON indicator lights up when EON signals are being received.

Presetting Volume for Traffic Information/News

Preset the volume level to be used for traffic information and news broadcasts.

- 1 Tune into the station for which you want to set the volume.
- 2 Adjust the volume to the desired level.
- 3 Hold down the VOL ADJ button for two seconds or more. The volume level blinks once in the display to indicate that the data has been stored.
Future traffic information/news broadcasts are heard at the preset level.

NOTE

- The volume cannot be lowered by this function during tuner reception. The volume is only set when it is louder than the listening volume of the tuner.
- You can arrange only to listen to traffic information or news bulletins with at preset volume with the volume set at minimum.

RDS features (See page 6)

News Bulletin Function with PTY News Timeout Setting

You can arrange to have news bulletins interrupt your current listening source, including other radio stations. When the News Bulletin function is on, the PTY News Timeout setting allows you to set the interval during which further news interruption cannot take place. You can adjust the PTY news interruption period from 10 to 90 minutes for each journey.

Turning News Bulletin Function On/Off:

- 1 Hold down the MENU button for one second or more. "MENU" is displayed and the menu mode is turned on.
- 2 Press the ►► button repeatedly until the News Bulletin function appears in the display. Press the ◄◄ button to search in the other direction. The function setting is indicated by "NEWS 00M" or "NEWS OFF" in the display, indicating that the function is on or off, respectively.

NOTE

Depending on the interval chosen, the "00M" in the display will change when the function is turned on.

3 Changing the Function Setting

Press either the FM or AM button.

Each time you press the FM or AM button until the desired setting is displayed.

Press the FM button to increase the interval, and the AM button to decrease it.

OFF ↔ 00M ↔ 10M ↔ 20M ↔ 30M ↔ 40M ↔ 50M ↔ 60M
↔ 70M ↔ 80M ↔ 90M (M= minutes)

When you select the news interruption timeout interval, the News function turns on and the NEWS indicator lights up.

When a news bulletin is received, the NEWS indicator will blink and reception will begin at the preset volume.

NOTE

If you choose the "20M" setting, further news bulletins will not be received for 20 minutes once the first news bulletin is received. Setting the interval at the "00M" factory default indicates no News Timeout will be made, meaning that additional news bulletins will continue to be searched for.

- 4 Press the MENU button to end the menu mode.

NOTE

- This function is only available if the desired station sends PTY-code for news bulletin or belongs to EON-Network sending PTY-code for news bulletin.
- If you turn on the news bulletin function in the MW/LW band, the band is switched automatically to the FM band. However, the MW/LW band is not returned to when you turn off the function.

Auto TP Seek Function

When the TI function is on and poor reception conditions are experienced when listening to a traffic information station, another traffic information station with better reception will be searched for automatically. This function is on, when unit is first powered on.

Turning Auto TP Seek Function On/Off:

- 1 Hold down the MENU button for one second or more. "MENU" is displayed and the menu mode is turned on.
- 2 Press the ►► button repeatedly until the Auto TP Seek function appears in the display. Press the ◄◄ button to search in the other direction. The function setting is indicated by "ATPS ON" or "ATPS OFF" in the display, indicating that the function is on or off, respectively.
- 3 **Switching settings**
Press either the AM button or FM button. The display and setting will change. If the traffic information station you are tuned to experiences poor reception, this function automatically seeks another TP station after about 30 seconds.
- 4 Press the MENU button to end the menu mode.

Cassette player features (See page 6)

Playing Cassette Tapes

Loading and Playing Cassettes:

Load a cassette with the tape exposed on the right. The tape starts playing automatically. With Side A facing up, the ► indicator lights up when Side A is playing, and ◀ when Side B is playing. The ◀ ► indicator lights up whilst play is stopped.

Playing Cassettes Already Loaded:

Press the ◀ ► button to start play.

Listening to the other side:

Press the ◀ ► button.
Tape play switches to the other side.

Stopping and Ejecting Cassettes:

Hold down the EJECT button for one second or more. The tape stops playing and the cassette ejects.

NOTE

Remove a cassette from the unit when not listening to it for a whilst. If you leave it in the unit too long, the tape may stick to the tape head and cause the unit to malfunction.

Fast Forwarding and Rewinding Cassette Tapes

Fast Forwarding Tapes:

Press the FM button. The tape indicator blinks in the direction of the tape as it is being fast forwarded. With Side A facing up, you see:
 ►► (Side A fast forwarding) ◀◀ (Side B fast forwarding)

Rewinding Tapes:

Press the AM button. The tape indicator blinks in the direction of the tape as it is being rewind. With Side A facing up, you see:
 ◀◀ (Side A rewinding) ►► (Side B rewinding)

Labelling:

Press the ◀ ► button.
Normal tape play returns.

Tuner Call Function

Switch automatically to the tuner whilst you are rewinding or fast forwarding the tape.

Turning Tuner Call Function On/Off:

Press the T.C button to switch the tuner call function on and off.
The T.C indicator lights up when the tuner call function is turned on.

Tape Advance Function

Rewinds to the beginning of the current track (or fast forwards to the beginning of the next track), continuing tape playback.

Rewinding tape to the beginning of current track:

Press the I◀◀ button, and the tape will rewind to the beginning of the current track and automatically start playing again.

To advance to the beginning of the next track:

Press the ►►I button, and the tape will advance to the beginning of the new track and automatically start playing again.

NOTE

The tape advance function "knows" where a track begins by detecting the blank space preceding it (i.e., the space between tracks). However, when the blank space lasts for less than 4 seconds or contains noise, this function may not operate correctly. Furthermore, sections recorded at low levels may trigger the function if they last for 4 seconds or more.

Blank Skip Function

Automatically fast forwards to the beginning of the next track when long blank spaces (10 seconds or more) are detected, continuing tape playback.

Turning Blank Skip Function On/Off:

Press the B.S button to switch the blank skip function on and off.

The B.S indicator lights up when the blank skip function is turned on.

NOTE

- If the blank space contains much noise, the blank skip function may not work right.
- Sections recorded at low levels may trigger the blank skip function if they last for 10 seconds or more.

Music Repeat Function

Repeatedly plays the current track.

Turning Music Repeat Function On/Off:

Press the REP button to switch the music repeat function on and off.

The REP indicator lights up when the music repeat function is turned on.

Canceling Music Repeat Function:

Press either the REP or ◀▶ button.

NOTE

The music repeat function "knows" where a track begins by detecting the blank space preceding it (i.e., the space between tracks). However, when the blank space lasts for less than 4 seconds or contains noise, this function may not operate correctly. Furthermore, sections recorded at low levels may trigger the function if they last for 4 seconds or more.

Disc changer control features *(See page 7)*

When the disc changer with the old/new selection switch is connected, set the switch to "O" (old) position to operate the disc changer mode.

Playing Discs Using Disc Changer

Playing Discs:

Press the CD•MD button.

The disc indicator lights up during disc changer mode.

When one disc has finished playing its last track, the next disc on the changer starts playing. When the last disc in the changer has finished, the player returns to the first disc and starts playing it.

Disc #10 is displayed as "0".

Pausing and Restarting Disc Play:

Press the ►|| button to make the disc pause.

Press the same button again to start play again.

Switching Display for Discs

Switch the display that appears whilst discs are playing.

Switching Display for Discs:

Each time you press the DISP button, the display during disc play switches as follows.

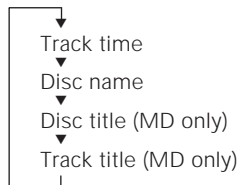

NOTE

- You can give names to discs through the presetting disc name function (see p. 23).
- If you try to display the name of a disc that does not have one, "NO NAME" is displayed instead.

Disc changer control features *(See page 7)*

Fast Forwarding and Reversing Disc Play

Fast Forwarding Disc Play:

Hold down on the ►► button.

Release your finger to play the disc at that point.

Reversing Disc Play:

Hold down on the ◀◀ button.

Release your finger to play the disc at the point.

NOTE

You cannot use reverse play between tracks when listening to an MD on the MD changer. Instead, the reverse play function is cancelled when it reaches the beginning of a track, at which point normal play automatically resumes.

Track Search

Search forwards or backwards through the tracks on the disc until you reach the one that you want to listen to.

Making a Reverse Track Search:

Press the ◀◀ button to display the desired track number.

Press once to search back to the beginning of the current track, twice to search back to the beginning of the previous track, and so forth.

Play starts at the beginning of the displayed track number.

NOTE

Pressing the ◀◀ button whilst listening to track 1 only searches back to the beginning of that track. The reverse search is not "recycled" to the last track on the disc.

Making a Forward Track Search:

Press the ►► button to display the desired track number.

Press once to fast forward to the next track, twice to fast forward to the track after that, and so forth.

Play starts at the beginning of the displayed track number.

NOTE

You cannot make a forward track search when listening to the last track on a disc.

Disc Search

Search forwards or backwards through the discs in a disc changer until you reach the one that you want to listen to.

Making a Reverse Disc Search:

Press the DISC- button to display the desired disc number.

Each time the button is pressed, the displayed disc number decreases by one.

Play starts at the beginning of the displayed disc.

Making a Forward Disc Search:

Press the DISC+ button to display the desired disc number.

Each time the button is pressed, the displayed disc number increases by one.

Play starts at the beginning of the displayed disc.

NOTE

"LOAD" is displayed when discs are being exchanged on the disc changer.

Function of remote control (See page 8)

Direct Track Search

Using the remote control, make direct input of the track number that you want to listen to.

- Using the numeric buttons on the remote control, enter the number of the track that you want to listen to.
The selected track number blinks in the display for 10 seconds. If you make no further input in the 10-second period, the number entry mode will automatically be cancelled.
- Press either the TRACK+ or TRACK- button whilst the track number is blinking.
The track specified in step 1 starts playing.

Cancelling Direct Track Search During Its Operation:

Press the ►|| button.

NOTE

You cannot use the direct track search function whilst doing track or disc scans or using random or magazine-random play.

Function of remote control (See page 8)

Direct Disc Search

Using the remote control, make direct input of the disc number that you want to listen to.

- 1 Using the numeric buttons on the remote control, enter the number of the disc that you want to listen to.
The selected disc number blinks in the display for 10 seconds.
If you make no further input in the 10-second period, the number entry mode will automatically be cancelled.

NOTE

- Input "0" to select disc #10.
 - If you enter more than two numbers all at once, a search will be made only of the last number entered.
- 2 Press either the DISC+ or DISC- button whilst the number inputted is blinking.
The disc specified in step 1 starts playing.

Cancelling Direct Disc Search During Its Operation:

Press the ►|| button.

Track / Disc Repeat Function

Repeat playing the current track or disc.

Turning Repeat Play Function On/Off:

Press the REP button to switch the repeat play function on and off as follows :

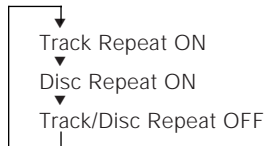

The REP indicator lights up when the repeat play function is turned on.
The track number blinks in the display when the track repeat function is on.
The disc number blinks in the display when the disc repeat function is on.

NOTE

The repeat play function is cancelled when you stop playing the disc.

Track Scan Function

Successively play the beginning of each track on a disc until you find the track that you want to listen to.

Turning Track Scan Function On/Off:

Press the SCN button to switch the track scan function on and off.

The SCN indicator lights up when the track scan function is turned on.

The first 10 seconds of each track are played, and the tracks are played in order.

The track number currently being heard blinks in the display.

Stopping to Listen to the Track Being Scanned:

Press the ►|| or SCN button again to stop the scan and keep on listening to a track normally.

NOTE

- The track scan function is cancelled when you stop playing a disc.
- The track scan function only scans each track on a disc once.

Disc changer control features *(See page 7)*

Disc Scan Function

Successively play the beginning of each disc on a changer until you find the one that you want to listen to.

Turning Disc Scan Function On/Off:

Press the D.SCN button to switch the disc scan function on and off.

The SCN indicator lights up when the scan function is turned on.

The first 10 seconds of each disc are played, in the order in which they are loaded on the changer.

The disc number currently being heard blinks in the display.

Stopping to Listen to the Disc Being Scanned:

Press the ►|| or D.SCN button again to stop the scan and keep on listening to the disc normally.

NOTE

- The disc scan function is cancelled when you stop playing a disc.
- The disc scan function only scans each disc on the changer once.
- "LOAD" is displayed when discs are being exchanged on the disc changer.

Random Play Function

Play all the tracks on the current disc in random order.

- 1 Press the RDM button to switch the random play function on and off.
The RDM indicator lights up when the random play function is turned on.
The display of the track number changes continuously as the next track is being selected.
When the track has been selected, play starts.
The selected track number blinks in the display as it is being played.

NOTE

When all the tracks on a certain disc have been played using the random play function, the next disc on the changer starts playing (with the random play function still turned on).

- 2 To change the track being heard, press the ►►| button.
Another track is selected and played.

NOTE

The random play function is cancelled when you stop playing a disc.

Magazine Random Play Function

Play the tracks on all the discs in the disc changer in random order.

- 1 Press the M.RDM button to switch the magazine random play function on and off.
The RDM indicator lights up when the magazine random play function is turned on.
The display of the disc and track numbers change continuously as the next track is being selected.
When the disc/track has been selected, play starts.
The selected disc/track number blinks in the display as it is being played.

NOTE

This function is not available with the following models:
KDC-C200/C300/C400/C301/C401

- 2 To change the track being heard, press the ►►| button.
Another disc/track is selected and played.

NOTE

- The magazine random play function is cancelled when you stop playing a disc.
- The time needed for random selection depends on the number of discs loaded in the disc magazine.

Presetting Disc Names

Store the names of discs to be displayed when played.

- 1 Press the disc whose name you want to preset.

NOTE

- This function is not available for disc changers that do not feature the Disc Name Preset function.
- This procedure is not to be used to store the disc and track titles for MDs that you record.

- 2 Hold down the NAME SET button for two seconds or more. "NAME SET" is displayed and the disc name preset mode is entered. The cursor blinks in the position where character input can be made.

- 3 Press either the **◀◀** or **▶▶** button to move the cursor to the desired position. The **◀◀** button moves the cursor to the left, and the **▶▶** button to the right. You can also move the cursor left or right by pressing the TRACK+ or TRACK- buttons, respectively, on the remote control.

- 4 Press the DISC+ or DISC- button to display the desired character. Besides the alphabet (capital letters only) and numerals, you can choose the following characters: [, / , + , - , * , = , < , and > .

NOTE Direct Input (Function of remote control)

If the disc changers that were manufactured and sold after 1997 are connected, you can directly input letters using the number/letter entry buttons on the remote control. Example: Use the following table to enter the name "DANCE".

Character	Button to press	# Times pressed
" D "	#3	1
" A "	#2	1
" N "	#6	2
" C "	#2	3
" E "	#3	2

- 5 Continue steps 3 and 4 until all the characters are chosen for the name.

NOTE

You can enter up to 8 characters for each name.

- 6 Press either the NAME SET button on the main unit or the OK button on the remote control. The disc name is stored and the disc name preset mode is cancelled. If you make no entry in a 10-second period, the name will be stored with the characters entered so far.

NOTE

- The number of discs whose names can be stored will differ depending on the disc changer that is connected. Please see your disc changer manual for details.
- Discs are identified by their total length and number of tracks. If you play another CD that happens to have exactly the same specifications as another CD whose name is stored, the wrong name will be displayed for it.
- If you want to change the name of a disc, repeat steps 1 and 2 to display the name, and then repeat steps 3 and 4 to enter the changes.
- Pressing the reset button does not erase the disc names stored in a disc changer.

Other features (See page 7)

Audio Control Setting

Adjust various parameters of sound quality.

- 1 Press the AUD button to enter the control mode.
Each time the AUD button is pressed, the adjustment mode display changes as follows:

▶ Bass ▶ Treble ▶ Balance ▶ Fader ▶ Volume ◻

If you do not move to step 2 in 5 seconds, the unit will switch back to the volume adjustment mode (i.e., the normal mode).

NOTE Source tone memory

Each source (tape, FM, AM, and disc changer) has its own memory in which to store the bass and treble tone settings. The settings made for a particular source are then recalled automatically whenever you use that source (e.g., FM mode uses the tone settings made for FM, AM for AM, etc.).

- 2 Press the \vee/\wedge buttons to adjust the mode shown in the display.
Use the following table as a guide for adjusting the settings in each mode.

Adjustment mode (Display)	Operation of Audio control button	
	\vee button	\wedge button
Bass ("BAS")	Bass decreased.	Bass increased.
Treble ("TRE")	Treble decreased.	Treble increased.
Balance ("BAL")	Left channel emphasized.	Right channel emphasized.
Fader ("FAD")	Rear channel increased.	Front channel increased.

Clock Display

Display the time.

Switching to Time Display:

Press the CLK button repeatedly until the clock is displayed.

Adjusting Time

When the RDS station tuned into is transmitting a time signal, have the unit's built-in time adjust automatically to the correct local time.

Adjusting the Time:

Tune into an RDS station for 3 or 4 minutes.
The time adjusts automatically to the correct local time.

NOTE

- The displayed time cannot be set manually, but only through RDS station time signals.
- The time is not adjusted when the RDS station you are tuned to is not transmitting a time signal. Choose another RDS station in such a case.

TEL Mute Function

Shut down the audio system temporarily whenever an incoming call is received.

NOTE

The function will not work if a cable is not connected to the car phone.

When the telephone rings:

When a call is received, "CALL" is displayed and all the unit functions are temporarily interrupted.

Listening to Audio During Phone Call:

Press the TAPE, TUN, or CD•MD button.
The selected source will be heard.

"CALL" disappears from the display, and the volume of the original source is restored gradually.

Turning TEL Mute Function After Phone Call:

Hang the phone up.

"CALL" disappears from the display.

The original source (i.e., the one used before the phone call) is returned to automatically, and the volume restored gradually.

Selectable Illumination

You can switch the colour of the button illumination between green and amber.

- 1 Hold down the MENU button for one second or more. "MENU" is displayed and the menu mode is turned on.
- 2 Press the ►► button repeatedly until the Selectable Illumination function appears in the display. Press the ◄◄ button to search in the other direction. The function setting is indicated by "COL GRN" or "COL AMB" in the display, indicating that the current colour is green or amber, respectively.
- 3 **Switching settings**
Press either the AM button or FM button. The display and setting will change.
- 4 Press the MENU button to end the menu mode.

DSI (Disabled System Indicator)

A red indicator blinks on the unit after the faceplate is removed, warning potential thieves. The factory default for this function is "ON".

Turning Disabled System Indicator On/Off:

- 1 Hold down the MENU button for one second or more. "MENU" is displayed and the menu mode is turned on.
- 2 Press the ►► button repeatedly until the Disabled System Indicator function appears in the display. Press the ◄◄ button to search in the other direction. The function setting is indicated by "DSI ON" or "DSI OFF" in the display, indicating that the disable system indicator is on or off, respectively.

3 Switching settings

Press either the AM button or FM button. The display and setting will change.

- 4 Press the MENU button to end the menu mode.

Theft Deterrent Faceplate

The faceplate of the unit can be detached and taken with you, helping to deter theft.

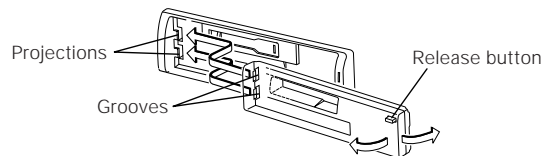

Removing Faceplate:

Press the release button.

The faceplate is unlocked, allowing you to detach it.

NOTE

- The faceplate is a precision piece of equipment and can be damaged by shocks or jolts. For that reason, keep the faceplate in its special storage case whilst detached.







- Do not expose the faceplate or its storage case to direct sunlight or excessive heat or humidity. Also avoid places with too much dust or the possibility of water splashing.

Reattaching Faceplate:

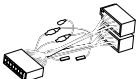
- 1 Align the projections on the unit with the grooves on the faceplate.
- 2 Push the faceplate in until it clicks. The faceplate is locked in place, allowing you to use the unit.

Accessories

	External view	Number of items
①	1
②	2
③	1
④	1

▲CAUTION

The use of any accessories except for those provided might result in damage to the unit. Make sure only to use the accessories shipped with the unit, as shown above.

Installation Procedure

1. To prevent short circuits, remove the key from the ignition and disconnect the ⊖ terminal of the battery.
2. Make the proper input and output cable connections for each unit.
3. Connect the cable on the wiring harness.
4. Take Connector B on the wiring harness and connect it to the speaker connector in your vehicle.
5. Take Connector A on the wiring harness and connect it to the external power connector on your vehicle.
6. Connect the wiring harness connector to the unit.
7. Install the unit in your car.
8. Reconnect the ⊖ terminal of the battery.
9. Press the reset button.

▲CAUTION

- If your car is not prepared for this special connection-system, consult your Kenwood dealer.
- Only use antenna conversion adapters (ISO-JASO) when the antenna cord has an ISO plug.
- Make sure that all cable connections are securely made by inserting jacks until they lock completely.
- If your vehicle's ignition does not have an ACC position, or if the ignition cable is connected to a power source with constant voltage such as a battery cable, the power will not be linked with the ignition (i.e., it will not turn on and off along with the ignition). If you want to link the unit's power with the ignition, connect the ignition cable to a power source that can be turned on and off with the ignition key.
- If the fuse blows, first make sure that the cables have not caused a short circuit, then replace the old fuse with one with the same rating.
- Do not let unconnected cables or terminals touch metal on the car or anything else conducting electricity. To prevent short circuits, also do not remove the caps on the ends of the unconnected cables or the terminals.
- Connect the speaker cables correctly to the terminals to which they correspond. The unit may receive damage or fail to work if you share the ⊖ cables and/or ground them to any metal part in the car.
- After the unit is installed, check whether the brake lamps, indicators, wipers, etc. on the car are working properly.
- Some disc changers need conversion cables for connection. See the section on "Safety Precautions" for details.
- Insulate unconnected cables with vinyl tape or other similar material.

Connecting Cables to Terminals

Antenna Conversion Adaptor (ISO-JASO) (Accessory④)

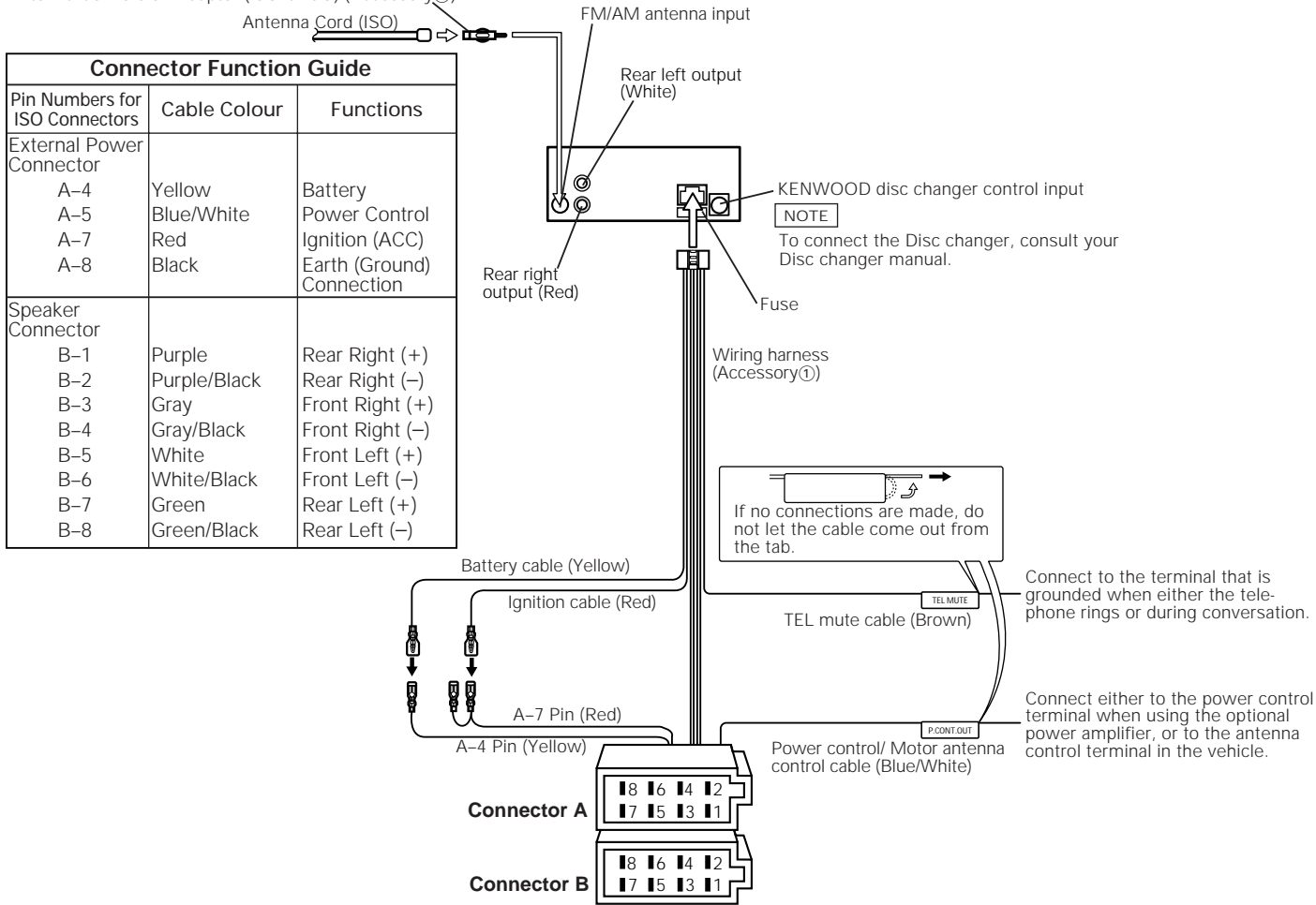

Connecting Cables to Terminals

▲WARNING Connecting the ISO Connector (see p.27)

The pin arrangement for the ISO connectors depends on the type of vehicle you drive. Make sure to make the proper connections to prevent damage to the unit.

The default connection for the wiring harness is described in **1** below. If the ISO connector pins are set as described in **2** or **3**, make the connection as illustrated.

- 1** (Default setting) The A-7 pin (red) of the vehicle's ISO connector is linked with the ignition, and the A-4 pin (yellow) is connected to the constant power supply.

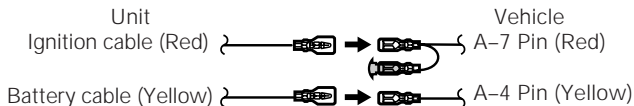

- 2** The A-7 pin (red) of the vehicle's ISO connector is connected to the constant power supply, and the A-4 pin (yellow) is linked to the ignition.

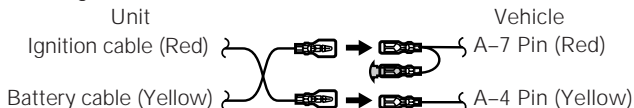

- 3** The A-4 pin (yellow) of the vehicle's ISO connector is not connected to anything, while the A-7 pin (red) is connected to the constant power supply (or both the A-7 (red) and A-4 (yellow) pins are connected to the constant power supply).

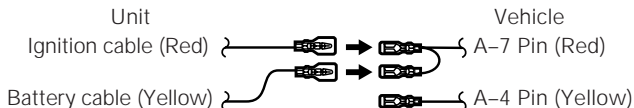

NOTE

When the connection is made as in **3** above, the unit's power will not be linked to the ignition key. For that reason, always make sure to turn off the unit's power when the ignition is turned off. To link the unit's power to the ignition, connect the ignition cable (ACC...red) to a power source that can be turned on and off with the ignition key.

Installation

■ Installation

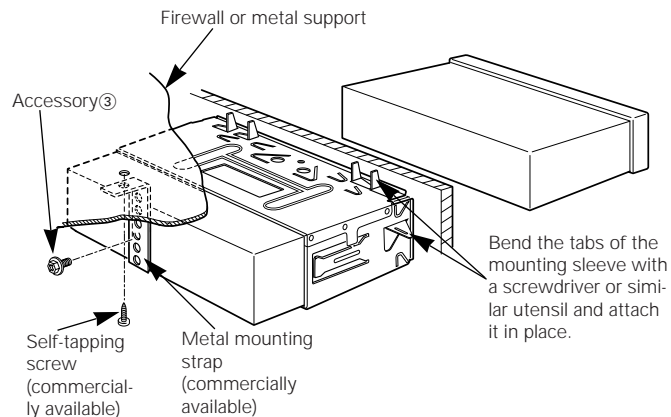

NOTE

Make sure that the unit is installed securely in place. If the unit is unstable, it may malfunction (eg, the sound may skip).

■ Removing the hard rubber frame

- 1 Engage the catch pins on the removal tool and remove the two locks on the lower level.
Lower the frame and pull it forward as shown in the figure.

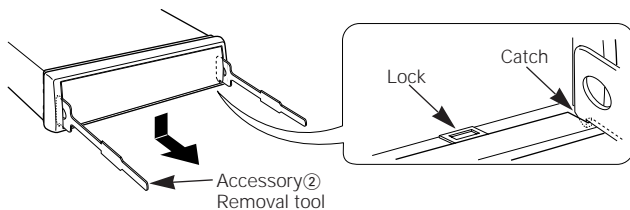

- 2 When the lower level is removed, remove the upper two locations.

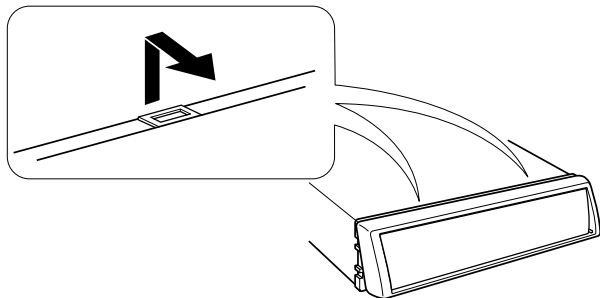

NOTE

The frame can be removed from the top side in the same manner.

■ Removing the Unit

- 1 Refer to the section "Removing the hard rubber frame" and then remove the hard rubber frame.
- 2 Remove the Hex-head screw with integral washer (M4x8) on the back panel.
- 3 Insert the two removal tools deeply into the slots on each side, as shown.

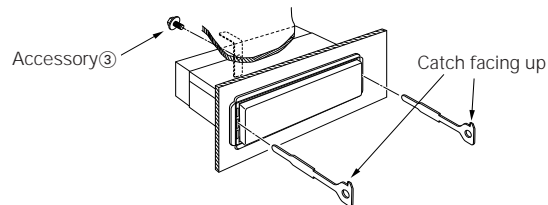

- 4 Lower the removal tool toward the bottom, and pull out the unit halfway whilst pressing towards the inside.

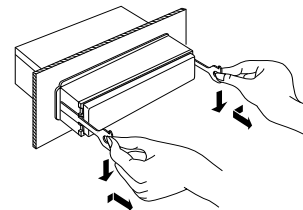

CAUTION

Be careful to avoid injury from the catch pins on the removal tool.

- 5 Pull the unit all the way out with your hands, being careful not to drop it.

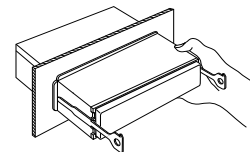

What might appear to be a malfunction in your unit may just be the result of slight misoperation or miswiring. Before calling service, first check the following table for possible problems.

PROBLEM	POSSIBLE CAUSE	SOLUTION
The power does not turn on.	The fuse has blown.	After checking for short circuits in the cables, replace the fuse with one having the same rating.
	No ACC position on vehicle ignition.	Connect the same cable to the ignition as the battery cable.
No sound can be heard, or the volume is low.	The Attenuator function is turned on.	Turn off the Attenuator function.
	The fader and/or balance settings are set all the way to one side.	Reset the fader and/or balance settings.
	The input/output cables or wiring harness are connected incorrectly.	Reconnect the input/output cables and/or the wiring harness correctly. See the section on "Connecting Cables to Terminals".
	The cassette tape is bad.	Try playing another cassette tape. If no problem is experienced, the first tape was bad.
Nothing happens when the buttons are pressed.	The computer chip in the unit is not functioning normally.	Press the reset button on the unit (see page 4).
The sound quality is poor or distorted.	The tape head is dirty.	Clean the tape head, referring to the section on "Cleaning the tape head" (see page 4).
	A speaker cable may be pinched by a screw in the car.	Check the speaker wiring.
	The speakers are not wired correctly.	Reconnect the speaker cables so that each output terminal is connected to a different speaker.
Radio reception is poor.	The car antenna is not extended.	Pull out the antenna all the way.
	The antenna control cable is not connected.	Connect the cable correctly, referring to the section on "Connecting Cables to Terminals".

PROBLEM	POSSIBLE CAUSE	SOLUTION
The memory is erased when the ignition is turned off.	The battery cable has not been connected to the proper terminal.	Connect the cable correctly, referring to the section on "Connecting Cables to Terminals".
	The ignition and battery cable are incorrectly connected.	Connect the cable correctly, referring to the section on "Connecting Cables to Terminals".
The TEL mute function does not work.	The TEL mute cable is not connected properly.	Connect the cable correctly, referring to the section on "Connecting Cables to Terminals".
The TEL mute function turns on even though the TEL mute cable is not connected.	The TEL mute cable is touching a metal part of the car.	Pull the TEL mute cable away from the metal part of the car.

Disc Changer

PROBLEM	POSSIBLE CAUSE	SOLUTION
The disc changer mode cannot be selected.	No cable has been connected to the disc changer input terminal on the unit.	Connect the cable to the disc changer input terminal on the unit.
	The old/new selection switch of the disc changer is not set properly.	Set the old/new selection switch to "O" (old) position.
The specified disc does not play, but another one plays instead.	The specified CD is very dirty.	Clean the CD.
	The CD is upside-down.	Load the CD with the labelled side up.
	The disc is loaded in a different slot from that specified.	Eject the disc magazine and check the number for the specified disc.
	The disc is severely scratched.	Try another disc instead.
The sound skips.	Something is touching the disc changer.	Remove whatever is touching it.
	The CD is scratched or dirty.	If skipping happens at the same place when the car is stopped, something is wrong with the CD. Clean the CD.
The display shows that the changer is being played, but no sound can be heard.	The computer chip in the unit is not functioning normally.	Press the reset button on the unit (see page 4).
The specified track does not play.	Random play or magazine random play has been selected.	Turn off the random play or magazine random play function.

The following messages are displayed when certain problems are occurring in your system. Take the recommended actions.

- EJECT** No disc magazine has been loaded in the changer. The disc magazine is not completely loaded.
 ⇨ Load the disc magazine properly.
- NO DISC** No disc has been loaded in the disc magazine.
 ⇨ Load a disc into the disc magazine.
- E-04** No disc has been loaded in the disc magazine.
 ⇨ Load a disc into the disc magazine.
 The CD is very dirty. The CD is upside-down. The CD is scratched a lot.
 ⇨ Clean the CD and load it correctly.
- BLANK** Nothing has been recorded on the MD.
 ⇨ The next MD is automatically played back
- NO TRACK** No tracks are recorded on the MD, although it has a title.
 ⇨ The next MD is automatically played back.
- E-77** The unit is malfunctioning for some reason.
E-99 ⇨ Press the reset button on the unit. If the "E- 77", "E- 99" code does not disappear, consult your nearest service centre.
- HOLD** The protective circuit in the unit activates when the temperature inside the automatic disc changer exceeds 60°C (140°F), stopping all operation.
 ⇨ Cool down the unit by opening the windows or turning on the air conditioner. As the temperature falls below 60°C (140°F), the disc starts playing again.
-  If this indicator continues blinking, it is possible that the tape has become jammed or tangled.
 ⇨ Contact the Kenwood dealer if the tape cassette cannot be ejected.

Specifications

Specifications subject to change without notice.

FM tuner section

Frequency range (50 kHz Space)	87.5 MHz – 108.0 MHz
Usable sensitivity (S/N = 26dB)	0.7 μ V/75 Ω
Quieting Sensitivity (S/N = 46dB)	1.6 μ V/75 Ω
Frequency response (\pm 3.0 dB)	30 Hz – 15 kHz
Signal to Noise ratio (MONO)	65 dB
Selectivity (DIN) (\pm 400 kHz)	\geq 80 dB
Stereo separation (1 kHz)	35 dB

MW tuner section

Frequency range (9 kHz Space)	531 kHz – 1611 kHz
Usable sensitivity (S/N = 20dB)	25 μ V

LW tuner section

Frequency range	153 kHz – 281 kHz
Usable sensitivity (S/N = 20dB)	45 μ V

Cassette player section

Tape speed	4.76 cm/sec.
Wow & Flutter (WRMS)	0.08 %
Frequency response(120 μ s)	30 Hz – 14 kHz (\pm 3 dB)
Separation (1 kHz)	40 dB
Signal to Noise ratio	54 dB

Audio section

Maximum output power	35 W \times 4
Output power (DIN 45324, +B=14.4 V)	25 W \times 4
Tone action	
Bass:	100 Hz \pm 10 dB
Treble:	10 kHz \pm 10 dB
Preout level / load	1800 mV / 10 k Ω
Preout Impedance	\leq 600 Ω

General

Operating voltage	14.4 V (11 – 16 V allowable)
Current consumption	10 A at rated power
Installation size (W \times H \times D)	182 \times 53 \times 154 mm
Weight	1.5 kg

KENWOOD