

JVC



ENGLISH

DEUTSCH

FRANÇAIS

NERLANDS

CASSETTE RECEIVER
CASSETTEN-RECEIVER
RADIOCASSETTE
RADIO/CASSETTESPELER

KS-FX922R/KS-FX822R

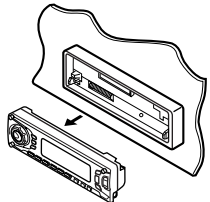

KS-FX922R

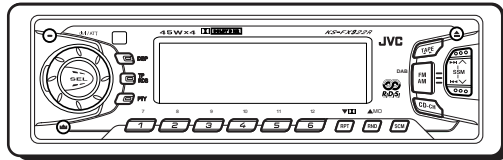
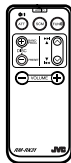

KS-FX822R

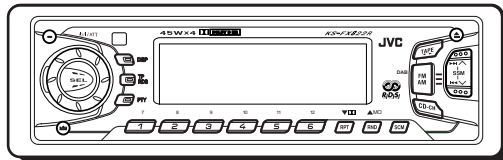

For installation and connections, refer to the separate manual.

Angaben zu Einbau und Verkabelung entnehmen Sie bitte der gesonderten Anleitung.

Pour l'installation et les raccordements, se référer au manuel séparé.

Zie de afzonderlijke handleiding voor details aangaande het installeren en verbinden van het toestel.

INSTRUCTIONS

BEDIENUNGSANLEITUNG
MANUEL D'INSTRUCTIONS
GEbruIKSAANWIJZING

Thank you for purchasing a JVC product. Please read all instructions carefully before operation, to ensure your complete understanding and to obtain the best possible performance from the unit.

CONTENTS

How to reset your unit	2	Using the sound control memory	20
Storing your own sound adjustments	21		
LOCATION OF THE BUTTONS	3	OTHER MAIN FUNCTIONS	22
Control panel	3	Setting the clock	22
Remote controller (only for KS-FX922R) ...	4	Changing the general settings (PSM)	22
Preparing the remote controller (only for KS-FX922R)	5	Detaching the control panel	25
BASIC OPERATIONS	6	CD CHANGER OPERATIONS	26
Turning on the power	6	Playing CDs	26
RADIO BASIC OPERATIONS	7	Selecting CD playback modes	27
Listening to the radio	7	EXTERNAL COMPONENT OPERATIONS ...	28
Storing stations in memory	8	Playing an external component	28
Tuning into a preset station	9	DAB TUNER OPERATIONS	29
RDS OPERATIONS	10	Tuning into an ensemble and one of the services	29
What you can do with RDS EON	10	Storing DAB services in memory	31
Other convenient RDS functions and adjustments	13	Tuning into a preset DAB service	32
TAPE OPERATIONS	16	What you can do more with DAB	32
Listening to a cassette	16	MAINTENANCE	33
Finding the beginning of a tune	17	TROUBLESHOOTING	34
Other convenient tape functions	18	SPECIFICATIONS	35
SOUND ADJUSTMENTS	19		
Adjusting the sound	19		

How to reset your unit

After detaching the control panel, press the reset button on the panel holder using a ball-point pen or similar tool.
This will reset the built-in microcomputer.

Note:

Your preset adjustments – such as preset channels or sound adjustments – will also be erased.

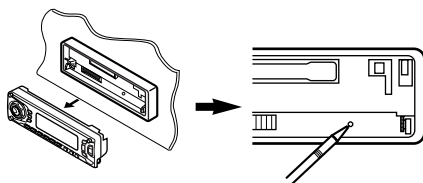

Note:

For security reasons, a numbered ID card is provided with this unit, and the same ID number is imprinted on the unit's chassis. Keep the card in a safe place, as it will help the authorities to identify your unit if stolen.

BEFORE USE

***For safety....**

- Do not raise the volume level too much, as this will block outside sounds, making driving dangerous.
- Stop the car before performing any complicated operations.

***Temperature inside the car....**

If you have parked the car for a long time in hot or cold weather, wait until the temperature in the car becomes normal before operating the unit.

LOCATION OF THE BUTTONS



Control panel

ENGLISH

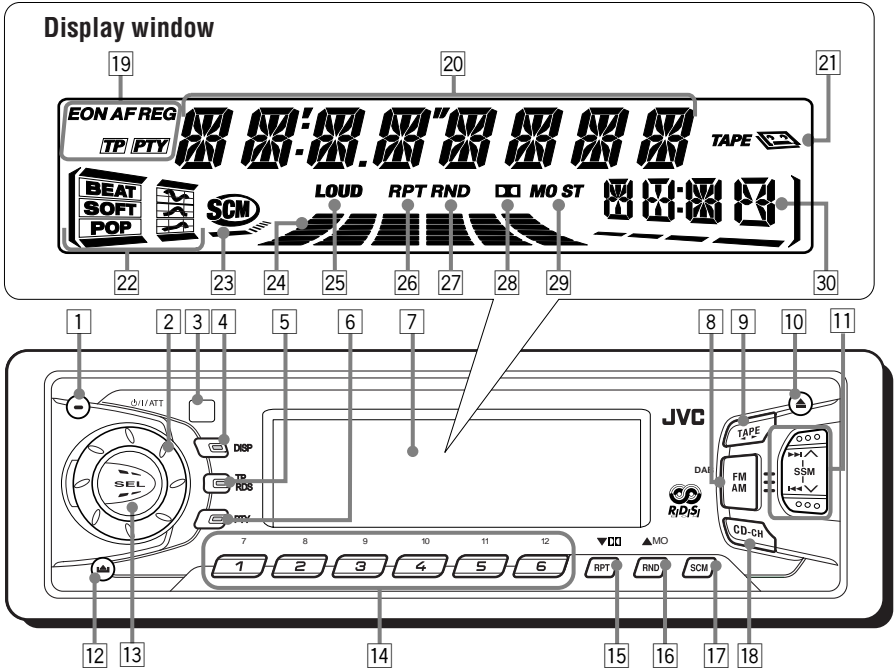

- 1 I/ATT (standby/on/attenuator) button
- 2 Control dial
- 3 Remote sensor
- 4 DISP (display) button
- 5 TP (traffic programme)
RDS (radio data system) button
- 6 PTY (programme type) button
- 7 Display window
- 8 FM AM button
• Also functions as the DAB button.
- 9 TAPE button
- 10 (eject) button
- 11 buttons
• Also functions as SSM buttons when pressed together.
- 12 (control panel release) button
- 13 SEL (select) button
- 14 Number buttons
- 15 RPT (repeat) button
 (Dolby B) button
• Also functions as (DAB service selection).

- 16 RND (random) button
MO (monaural) button
• Also functions as (DAB service selection).
- 17 SCM (sound control memory) button
- 18 CD-CH (CD changer) button

Display window

- 19 RDS indicators
EON, AF, REG, TP, PTY
- 20 Main display
- 21 TAPE indicator
- 22 Sound mode indicators
BEAT, SOFT, POP
- 23 SCM indicator
- 24 Volume (or audio) level indicator
- 25 LOUD indicator
- 26 RPT (repeat) indicator
- 27 RND (random) indicator
- 28 (Dolby B) indicator
- 29 Tuner reception indicators
MO (monaural), ST (stereo)
- 30 Source/clock display



Remote controller

(only for KS-FX922R)

This section is only for KS-FX922R.

KS-FX822R can also be remotely controlled as instructed here (with an optionally purchased remote controller). We recommend that you use remote controller RM-RK31 with your unit.

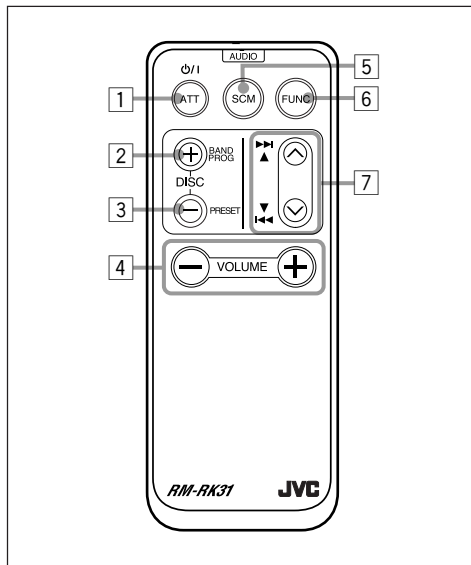

- 1 • Turns on the unit if pressed when the unit is turned off.
 - Turns off the unit if pressed and held until "SEE YOU" appears on the display.
 - Drops the volume level in a moment if pressed briefly.
Press again to resume the volume.
- 2 • Functions as the BAND button while listening to the FM broadcast (or the DAB tuner). Each time you press the button, the band changes.
 - Functions as the DISC + button while listening to the CD changer. Each time you press the button, the disc number increases, and the selected disc starts playing.
 - Functions as the PROG button while listening to a tape. Each time you press the button, the tape direction changes alternately.

- 3 • Functions as the PRESET button while listening to the radio (or the DAB tuner). Each time you press the button, the preset station (or service) number increases, and the selected station (or service) is tuned into.
 - Functions as the DISC – button while listening to the CD changer. Each time you press the button, the disc number decreases, and the selected disc starts playing.
- 4 Functions the same as the control dial on the main unit.

NOTE: This button does not function for the preferred setting mode adjustment.
- 5 Selects the sound mode. Each time you press the button, the mode changes.
- 6 Selects the source. Each time you press the button, the source changes.
- 7 • Searches stations while listening to the radio.
 - Selects services while listening to the DAB tuner if pressed briefly.
 - Searches ensembles while listening to the DAB tuner if pressed for more than 1 second.
 - Functions as the fast forward/rewind buttons or multi music scan buttons while listening to a tape.
 - Fast-forwards or reverses the track if pressed and held while listening to a CD.
 - Skips to the beginning of the next track or goes back to the beginning of the current (or previous tracks) if pressed briefly while listening to a CD.



Preparing the remote controller

(only for KS-FX922R)

This section is only for KS-FX922R.

KS-FX822R can also be remotely controlled as instructed here (with an optionally purchased remote controller). We recommend that you use remote controller RM-RK31 with your unit.

Before using the remote controller:

- Aim the remote controller directly at the remote sensor on the main unit. Make sure there is no obstacle in between.

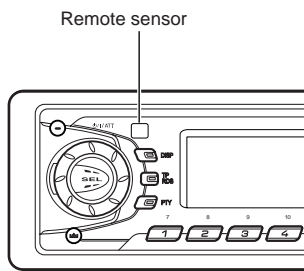

- Do not expose the remote sensor to strong light (direct sunlight or artificial lighting).

Installing the battery

When the controllable range or effectiveness of the remote controller decreases, replace the battery.

1. Remove the battery holder.

- 1) Push out the battery holder in the direction indicated by the arrow using a ball-point pen or a similar tool.
- 2) Remove the battery holder.

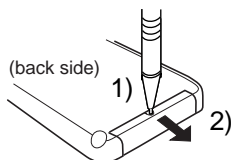

2. Place the battery.

Slide the battery into the holder with the + side facing upwards so that the battery is fixed in the holder.

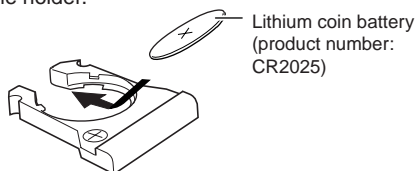

Lithium coin battery
(product number:
CR2025)

3. Return the battery holder.

Insert again the battery holder pushing it until you hear a clicking sound.

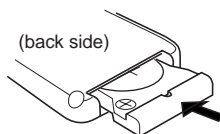

WARNING:

- Store the battery in a place where children cannot reach.
If a child accidentally swallows the battery, consult a doctor immediately.
- Do not recharge, short, disassemble or heat the battery or dispose it in a fire.
Doing any of these things may cause the battery to give off heat, crack or start a fire.
- Do not leave the battery with other metallic materials.
Doing this may cause the battery to give off heat, crack or start a fire.
- When throwing away or saving the battery, wrap it in tape and insulate; otherwise, the battery may start to give off heat, crack or start a fire.
- Do not poke the battery with tweezers or similar tools.
Doing this may cause the battery to give off heat, crack or start a fire.



BASIC OPERATIONS

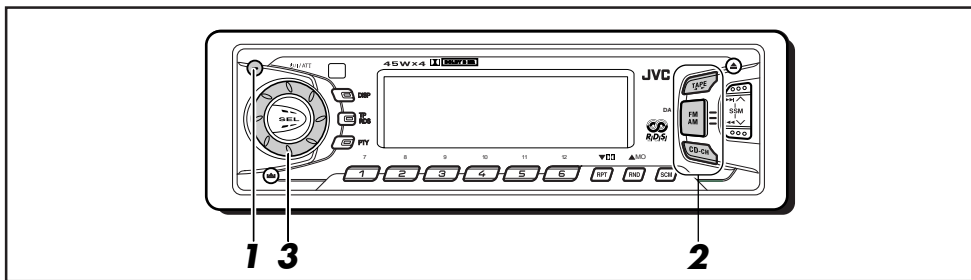

Turning on the power

1 Turn on the power.



Note on One-Touch Operation:

When you select a source in step 2 below, the power automatically comes on. You do not have to press this button to turn on the power.

2 Select the source.

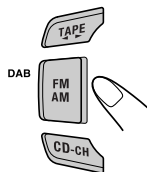

To operate the tuner (FM or AM), see pages 7 – 15.

To operate the tape, see pages 16 – 18.

To operate the CD changer, see pages 26 – 27.

To operate the external component, see page 28.

To operate the DAB tuner, see pages 29 – 32.

3 Adjust the volume.

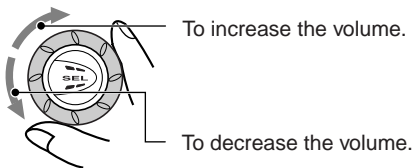

Volume level appears.

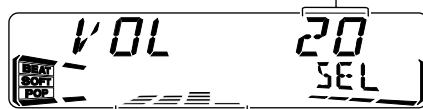

Volume or audio level (see page 24) indicator

4 Adjust the sound as you want. (See page 19.)

To drop the volume in a moment

Press I/ATT briefly while listening to any source. "ATT" starts flashing on the display, and the volume level will drop in a moment.

To resume the previous volume level, press the button briefly again.

- If you turn the control dial clockwise, you can also restore the sound.

To turn off the power

Press and hold I/ATT until "SEE YOU" appears on the display.

Note:

When you use this unit for the first time, set the built-in clock correctly, see page 22.

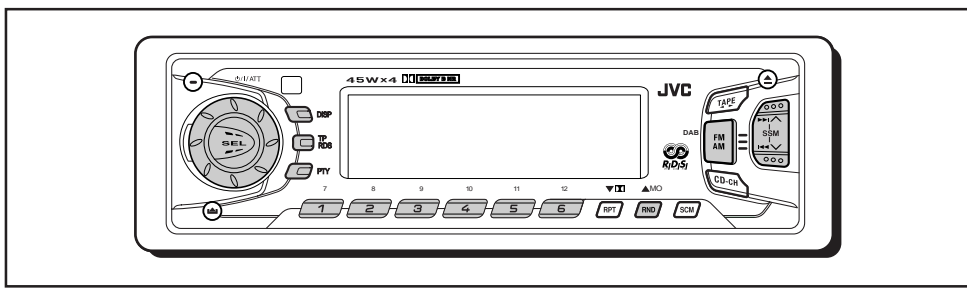

Listening to the radio

You can use either automatic searching or manual searching to tune into a particular station.

Searching a station automatically: Auto search

1 Select the band (FM1 – 3, AM).

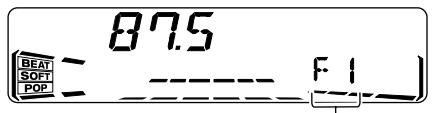
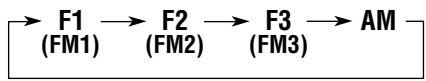
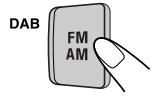

Selected band appears.

Note:
This receiver has three FM bands (FM1, FM2, FM3). You can use any one of them to listen to an FM broadcast.

2 Start searching a station.

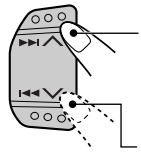

Press **▶▶|▲** to search stations of higher frequencies.

Press **◀◀|▼** to search stations of lower frequencies.

When a station is received, searching stops.

To stop searching before a station is received, press the same button you have pressed for searching.

Searching a station manually: Manual search

1 Select the band (FM1 – 3, AM).

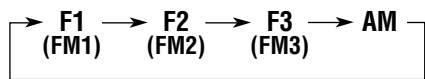

Note:
This receiver has three FM bands (FM1, FM2, FM3). You can use any one of them to listen to an FM broadcast.

2 Press and hold **▶▶|▲** or **◀◀|▼** until “MANU” (manual) starts flashing on the display.

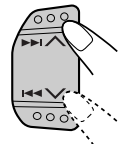

Selected band appears.

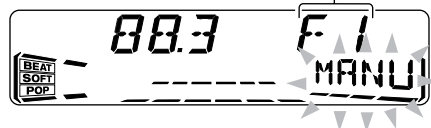

CONTINUED ON THE NEXT PAGE



3 Tune into a station you want while “MANU” is flashing.

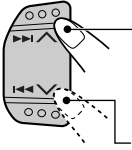

Press ►► ▲ to tune into stations of higher frequencies.

Press ◀◀ ▼ to tune into stations of lower frequencies.

- If you release your finger from the button, the manual mode will automatically turn off after 5 seconds.
- If you hold down the button, the frequency keeps changing (in 50 kHz intervals for FM and 9 kHz intervals for AM – MW/LW) until you release the button.

When an FM stereo broadcast is hard to receive:

Press MO RND (monaural/random) while listening to an FM stereo broadcast.

- Each time you press the button, the MO indicator lights up and goes off alternately.

Lights up when receiving an FM broadcast in stereo.

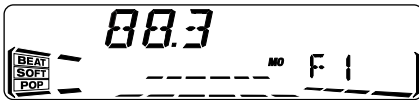
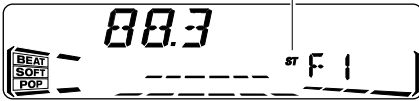

When the MO indicator is lit on the display, the sound you hear becomes monaural but the reception will be improved (the ST indicator goes off).

Storing stations in memory

You can use one of the following two methods to store broadcasting stations in memory.

- Automatic preset of FM stations: SSM (Strong-station Sequential Memory)
- Manual preset of both FM and AM stations

FM station automatic preset: SSM

You can preset 6 local FM stations in each FM band (FM1, FM2 and FM3).

1 Select the FM band (FM1 – 3) you want to store FM stations into.



Each time you press the button, the FM band changes as follows:

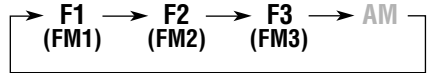

2 Press and hold both buttons for more than 2 seconds.

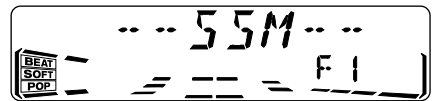
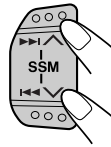

“SSM” appears, then disappears when automatic preset is over.

Local FM stations with the strongest signals are searched and stored automatically in the band number you have selected (FM1, FM2 or FM3). These stations are preset in the number buttons — No.1 (lowest frequency) to No.6 (highest frequency). When automatic preset is over, the station stored in number button 1 will be automatically tuned into.

Manual preset

You can preset up to 6 stations in each band (FM1, FM2, FM3 and AM) manually.

Ex.: Storing an FM station of 88.3 MHz into the preset number 1 of the FM1 band

1 Select the band (FM1 – 3, AM) you want to store stations into (in this example, FM1).

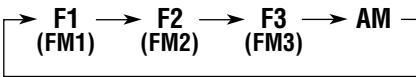
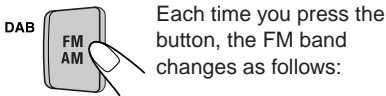

2 Tune into a station of 88.3 MHz.

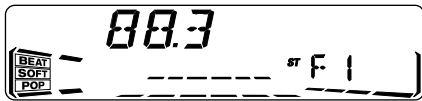
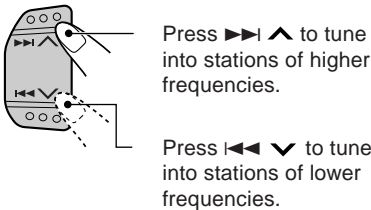

3 Press and hold the number button (in this example, 1) for more than 2 seconds.

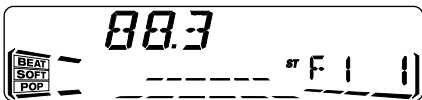

Selected band/preset number and "MEMO" (memory) appear alternately for a while.

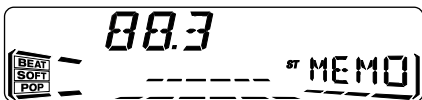

4 Repeat the above procedure to store other stations into other preset numbers.

Notes:

- A previously preset station is erased when a new station is stored in the same preset number.
- Preset stations are erased when the power supply to the memory circuit is interrupted (for example, during battery replacement). If this occurs, preset the stations again.

Tuning into a preset station

You can easily tune into a preset station. Remember that you must store stations first. If you have not stored them yet, see "Storing stations in memory" on page 8.

1 Select the band (FM1 – 3, AM).

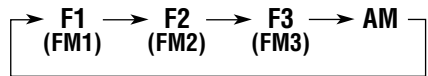

2 Select the number (1 – 6) for the preset station you want.

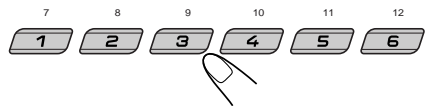



RDS OPERATIONS

ENGLISH

What you can do with RDS EON

RDS (Radio Data System) allows FM stations to send an additional signal along with their regular programme signals. For example, the stations send their station names, as well as information about what type of programme they broadcast, such as sports or music, etc.

Another advantage of RDS function is called "EON (Enhanced Other Networks)." The EON indicator lights up while receiving an FM station with the EON data. By using the EON data sent from a station, you can tune into a different station of a different network broadcasting your favorite programme or traffic announcement while listening to another programme or to another source such as tape.

By receiving the RDS data, this unit can do the following:

- Tracing the same programme automatically (Network-Tracking Reception)
- Standby Reception of TA (Traffic Announcement) or your favorite programme
- PTY (Programme Type) search
- Programme search
- And some other functions

Tracing the same programme automatically (Network-Tracking Reception)

When driving in an area where FM reception is not good, the tuner built in this unit automatically tunes into another RDS station, broadcasting the same programme with stronger signals. So, you can continue to listen to the same programme in its finest reception, no matter where you drive. (See the illustration on the next page.)

Two types of the RDS data are used to make Network-Tracking Reception work correctly — PI (Programme Identification) and AF (Alternative Frequency).

Without receiving these data correctly from the RDS station you are listening to, Network-Tracking Reception will not operate.

To use Network-Tracking Reception, press and hold TP RDS (Traffic Programme/Radio Data System) for more than 1 second. Each time you press and hold the button, Network-Tracking Reception modes change as follows:

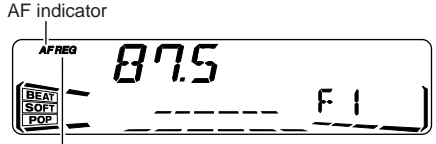
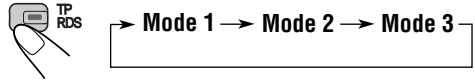

Mode 1

The AF indicator lights up but the REG indicator does not.

Network-Tracking Reception is activated with Regionalization set to "off."

Switches to another station within the same network when the receiving signals from the current station become weak.

- In this mode, the programme may differ from the one currently received.

Mode 2

Both the AF indicator and the REG indicator light up.

Network-Tracking Reception is activated with Regionalization set to "on."

Switches to another station, within the same network, broadcasting the same programme when the receiving signals from the current station become weak.

Mode 3

Neither the AF indicator nor the REG indicator lights up.

Network-Tracking Reception is deactivated.



The same programme can be received on different frequencies.

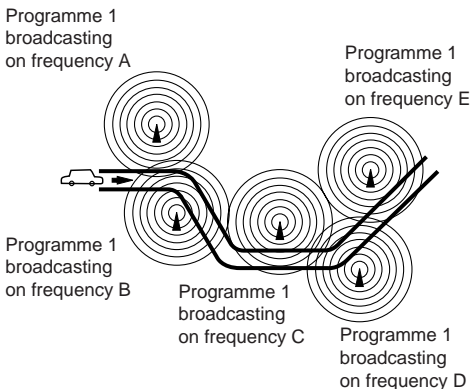

PTY Standby Reception



When you press PTY while listening to an FM station, the PTY indicator is lit during reception of a PTY station and the PTY standby mode is engaged. The selected PTY name stored on page 12 flashes for 5 seconds.

- When the station being received is not a PTY station, the PTY indicator flashes. Press **▶▶|▲** or **◀◀|▼** to engage the PTY standby mode. "SEARCH" appears on the display, and PTY station search starts. When a PTY station is tuned into, the PTY indicator is lit.
- If you are listening to a tape or other connected components and wish to listen to a selected PTY broadcast, press PTY to enter the PTY standby mode. (The PTY indicator lights up.)

If the selected PTY programme starts broadcasting while the PTY standby mode is active, the selected PTY name appears and the playback source changes to the FM band. The selected PTY programme can then be heard.

To deactivate the PTY standby mode, press PTY again.

Using Standby Reception

Standby Reception allows the unit to switch temporarily to your favorite programme (PTY: Programme Type) and Traffic Announcement (TA) from the current source (another FM station, tape or other connected components).

- Standby Reception will not work if you are listening to an AM station.

TA Standby Reception



When you press TP RDS while listening to an FM station, the TP indicator is lit during reception of a TP (Traffic Programme) station and the TA standby mode is engaged.

- When the station being received is not a TP station, the TP indicator flashes. Press **▶▶|▲** or **◀◀|▼** to engage the TA standby mode. "SEARCH" appears on the display, and TP station search starts. When a TP station is tuned into, the TP indicator is lit.
- If you are listening to a tape or other connected components and wish to listen to a TP station, press TP RDS to enter the TA standby mode. (The TP indicator lights up.)

If a traffic programme starts broadcasting while the TA standby mode is active, "TRAFFIC" appears and the playback source changes to the FM band. The volume increases to the preset TA volume level (see page 14) and the traffic programme can be heard.

To deactivate the TA standby mode, press TP RDS again.



Selecting your favorite programme for PTY Standby Reception

You can select your favorite programme for PTY Standby Reception to store in memory. When shipped from the factory, "NEWS" is stored as the programme type for PTY Standby Reception.

- 1 Press and hold SEL (select) for more than 2 seconds so that one of the PSM items appears on the display. (PSM: see page 23.)



- 2 Select "PTY STBY" (standby) if not shown on the display.

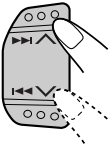

- 3 Select one of twenty-nine PTY codes. (See page 15.)



Selected code name appears on the display and is stored into memory.

- 4 Press SEL (select) to finish the setting.



Searching your favorite programme

You can search one of your 6 favorite programme types stored in memory. When shipped from the factory, the following 6 programme types have been stored in the number buttons (1 to 6).

To store your favorite programme types, see below.

To search your favorite programme type, see page 13.

1	2	3
POP M	ROCK M	EASY M
4	5	6
CLASSICS	AFFAIRS	VARIED

To store your favorite programme types

- 1 Press and hold SEL (select) for more than 2 seconds so that one of the PSM items appears on the display. (PSM: see page 23.)



- 2 Select "PTY SRCH" (search) if not shown on the display.



- 3 Select one of twenty-nine PTY codes. (See page 15.)



Selected code name appears on the display.

- If the code already stored in memory is selected, it will flash on the display.



4 Press and hold the number button for more than 2 seconds to store the PTY code selected into the preset number you want.

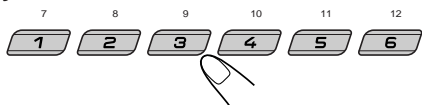

The selected code name and "MEMO" (memory) appear alternately on the display.

5 Press SEL (select) to finish the setting.



To search your favorite programme type

1 Press and hold PTY (programme type) for more than 1 second while listening to an FM station.

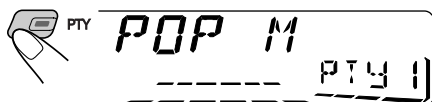

The last selected PTY code appears.

2 Select one of the PTY codes stored in the preset number buttons (1 to 6).

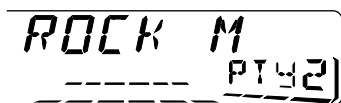
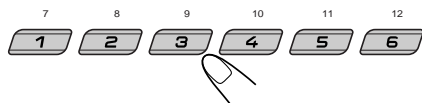

Ex.: When "ROCK M" is stored in preset number button 2

PTY search for your favorite programme starts after 5 seconds.

- If there is a station broadcasting a programme of the same PTY code as you selected, that station is tuned into.
- If there is no station broadcasting a programme of the same PTY code as you selected, the station will not change.

Note:

In some areas, the PTY search will not work correctly.

Other convenient RDS functions and adjustments

Automatic selection of the station when using the number buttons

Usually when you press the number button, the preset station is tuned into.

However, when the preset station is an RDS station, something different will happen. If the signals from that preset station are not sufficient for good reception, this unit, using the AF data, tunes into another frequency broadcasting the same programme as the original preset station is broadcasting. (Programme search)

- The unit takes some time to tune into another station using Programme search.

To activate programme search, follow the procedure below.

- See also "Changing the general settings (PSM)" on page 22.

- 1 Press and hold SEL (select) for more than 2 seconds so that one of the PSM items appears on the display.
- 2 Press **▶▶** **▲** or **◀◀** **▼** to select "P(Programme)-SEARCH."
- 3 Turn the control dial clockwise to select "ON."
Now programme search is activated.
- 4 Press SEL (select) to finish the setting.

To cancel programme search, repeat the same procedure and select "OFF" in step 3 by turning the control dial counterclockwise.



Changing the display mode while listening to an FM station

You can change the initial indication on the display to station name (PS NAME) or station frequency (FREQ) while listening to an FM RDS station.

- See also “Changing the general settings (PSM)” on page 22.

- 1 Press and hold SEL (select) for more than 2 seconds so that one of the PSM items appears on the display.
- 2 Press ►►| ^ or |◄◄ v to select “TU DISP” (tuner display).
- 3 Turn the control dial to set to the desired indication (“PS NAME” or “FREQ”).
- 4 Press SEL (select) to finish the setting.

Note:

By pressing DISP, you can change the display while listening to an FM RDS station only.

Each time you press the button, the following information appears on the display:

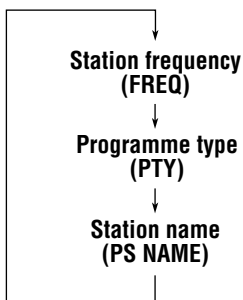

- Then, the display goes back to the original indication in several seconds.

Setting the TA volume level

You can preset the volume level for TA Standby Reception. When a traffic programme is received, the volume level automatically changes to the preset level.

- See also “Changing the general settings (PSM)” on page 22.

- 1 Press and hold SEL (select) for more than 2 seconds so that one of the PSM items appears on the display.
- 2 Press ►►| ^ or |◄◄ v to select “TA VOL.”
- 3 Turn the control dial to set to the desired volume. You can set it from “VOL 00” to “VOL 50.”
- 4 Press SEL (select) to finish the setting.

Automatic clock adjustment

When shipped from the factory, the clock built in this unit is set to be readjusted automatically using the CT (Clock Time) data in the RDS signal.

If you do not want to use automatic clock adjustment, follow the procedure below.

- See also “Changing the general settings (PSM)” on page 22.

- 1 Press and hold SEL (select) for more than 2 seconds so that one of the PSM items appears on the display.
- 2 Press ►►| ^ or |◄◄ v to select “AUTO ADJ.”
- 3 Turn the control dial counterclockwise to select “OFF.”
Now automatic clock adjustment is canceled.
- 4 Press SEL (select) to finish the setting.

To reactivate clock adjustment, repeat the same procedure and select “ON” in step 3 by turning the control dial clockwise.

Note:

You must stay tuned to the same station for more than 2 minutes after setting “AUTO ADJ” to “ON.” Otherwise, the clock time will not be adjusted. (This is because the unit takes up to 2 minutes to capture the CT data in the RDS signal.)

**PTY codes**

NEWS:	News	SOCIAL:	Programmes on social activities
AFFAIRS:	Topical programmes expanding on current news or affairs	RELIGION:	Programmes dealing with any aspect of belief or faith, or the nature of existence or ethics
INFO:	Programmes which impart advice on a wide variety of topics	PHONE IN:	Programmes where people can express their views either by phone or in a public forum
SPORT:	Sport events	TRAVEL:	Programmes about travel destinations, package tours, and travel ideas and opportunities
EDUCATE:	Educational programmes	LEISURE:	Programmes concerned with recreational activities such as gardening, cooking, fishing, etc.
DRAMA:	Radio plays	JAZZ:	Jazz music
CULTURE:	Programmes on national or regional culture	COUNTRY:	Country music
SCIENCE:	Programmes on natural science and technology	NATION M:	Current popular music from another nation or region, in that country's language
VARIED:	Other programmes like comedies or ceremonies	OLDIES:	Classic pop music
POP M:	Pop music	FOLK M:	Folk music
ROCK M:	Rock music	DOCUMENT:	Programmes dealing with factual matters, presented in an investigative style
EASY M:	Easy-listening music		
LIGHT M:	Light music		
CLASSICS:	Classical music		
OTHER M:	Other music		
WEATHER:	Weather information		
FINANCE:	Reports on commerce, trading, the Stock Market, etc.		
CHILDREN:	Entertainment programmes for children		



TAPE OPERATIONS

ENGLISH

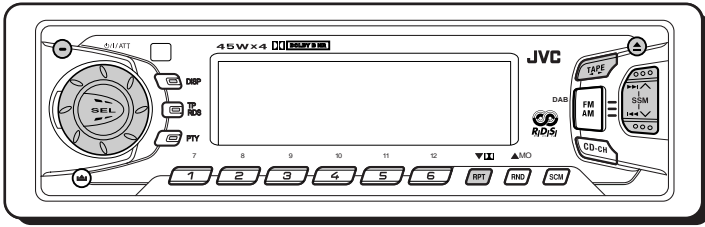

Listening to a cassette

1 Open the control panel.

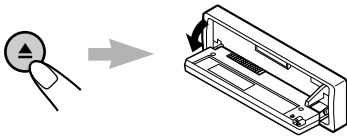

2 Insert a cassette into the cassette compartment.

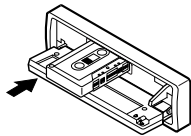

The unit turns on and tape play starts automatically.

3 Close the control panel by hand.

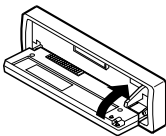

TAPE indicator appears.



4 Select the tape direction.



Each time you press TAPE ◀▶, the tape direction changes alternately forward (*FW PLAY*) and reverse (*REV PLAY*).

Note on One-Touch Operation:

When a cassette is already in the cassette compartment, select tape as the source by pressing TAPE ◀▶ to start tape play.

To stop play and eject the cassette

Press ▲.

Tape play stops and the cassette automatically ejects from the cassette compartment. The source changes to the previously selected one. If you change the source, tape play also stops (without ejecting the cassette this time).

- You can eject the cassette while the unit is turned off by pressing ▲.

To fast-forward and rewind a tape

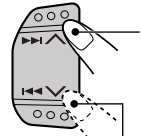

Press ▶▶ ▲ for more than 1 second to fast-forward the tape. When the tape reaches its end, the tape is reversed and playback starts from the beginning of the other side.

Press ◀◀ ▼ for more than 1 second to rewind the tape. When the tape reaches its end, playback of the same side starts.

To stop fast forward and rewind at any position on the tape, press TAPE ◀▶.

Tape play starts from that position on the tape.

Notes:

- When one side of the tape reaches its end during play, the other side of the tape automatically starts playing. (Auto Reverse)
- When the tape reaches its end while fast-forwarding, the tape direction will be changed automatically.



To play back tapes recorded with the Dolby B NR

Press and hold **⏮** RPT (Dolby B/repeat) to set the Dolby B NR* system.

The **⏮** indicator lights up, and “DOLBY B” appears on the display for several seconds.

To cancel the Dolby B NR, press and hold **⏮** RPT (Dolby B/repeat) again so that the **⏮** indicator goes off.

*Dolby noise reduction manufactured under license from Dolby Laboratories Licensing Corporation.
“DOLBY” and the double-D symbol **⏮** are trademarks of Dolby Laboratories Licensing Corporation.

Finding the beginning of a tune

Multi Music Scan allows you to automatically start playback from the beginning of a specified tune. You can specify up to 9 tunes ahead of or before the current tune.

During playback

Specify how many tunes ahead of or before the current tune the one you want is located.

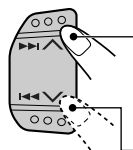

Press **▶▶** **▲** to locate a tune ahead of the current tune on the cassette.

Press **◀◀** **▼** to locate a tune before the current tune on the cassette.

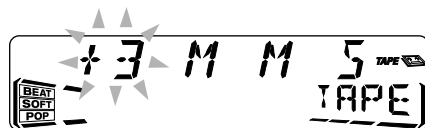

Each time you press the buttons, the number changes up to ± 9 .

When the beginning of the specified tune is located, playback starts automatically.

Notes:

- *While locating a specified tune:*
 - If the tape is rewound to its beginning, playback starts from the beginning of that side.
 - If the tape is fast-forwarded to the end, it is reversed and played from the beginning of the other side.
- *In the following cases, the Multi Music Scan function may not operate correctly:*
 - Tapes with tunes having long pianissimo passages (very quiet parts) or non-recorded portions between tunes.
 - Tapes with short non-recorded sections.
 - Tapes with high level of noise or humming between tunes.
 - The Dolby NR setting does not match. For example, if Dolby B NR is on and the tape was recorded with no Dolby NR.

Prohibiting cassette ejection

You can prohibit cassette ejection and “lock” a cassette in the cassette compartment.

Press and hold TAPE **◀▶** and **⏻**/I/ATT for more than 2 seconds.

“NO EJECT” flashes on the display for about 5 seconds, and the cassette is “locked.”

To cancel the prohibition and “unlock” the cassette, press and hold TAPE **◀▶** and **⏻**/I/ATT for more than 2 seconds again.

“EJECT OK” flashes for about 5 seconds, and this time the cassette is “unlocked.”

Note:

If you press **▲** while cassette ejection is prohibited, the display panel flips down, but the cassette continues to play and cannot be ejected.



Other convenient tape functions

Skipping the blank portions on the tape

You can skip blank portions between the tunes (Blank Skip).

When this function is on, the unit skips blank portions of 15 seconds or more, fast-forwards to the next tune, then starts playing it.

- See also “Changing the general settings (PSM)” on page 22.

- 1 Press and hold SEL (select) for more than 2 seconds so that one of the PSM items appears on the display. (PSM: see page 23.)**



- 2 Press >>> ^ or <<< v to select “B. SKIP” (blank skip).**

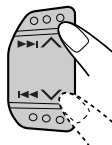

- 3 Turn the control dial clockwise to select “ON.”**



Now Blank Skip is activated.

- 4 Press SEL (select) to finish the setting.**



To cancel Blank Skip, repeat the same procedure and select “OFF” in step 3 by turning the control dial counterclockwise.

Playing the current tune repeatedly

You can play the current tune repeatedly (Repeat Play).

- Press RPT (repeat/Dolby B) while playing a tune you want to hear over again.**



Each time you briefly press the button, Repeat Play turns on and off alternately.

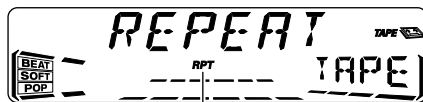

Lights up when Repeat Play is turned on.

When the tune has been played, the tape is automatically rewound to the beginning of that tune and the same tune will be played again.

To cancel Repeat Play, press RPT (repeat/Dolby B) again so that the RPT indicator goes off.

Note:

In the following cases, Blank Skip and Repeat Play may not operate correctly:

- Tapes with tunes having long pianissimo passages (very quiet parts) or non-recorded portions during tunes.
- Tapes with short non-recorded sections.
- Tapes with high level noise or humming between tunes.
- The Dolby NR setting does not match. For example, if Dolby B NR is on and the tape was recorded with no Dolby NR.



Adjusting the sound

You can adjust the sound characteristics to your preference.

1 Select the item you want to adjust.



Each time you press the button, the adjustable items change as follows:

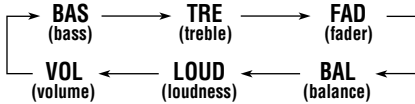

2 Adjust the level.

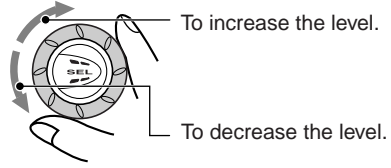

Equalization pattern changes as you adjust the bass or treble.

Note:

Normally, the control dial works as the volume control. So you do not have to select "VOL" to adjust the volume level.

Indication	To do:	Range
BAS	Adjust the bass.	-06 (min.) +06 (max.)
TRE	Adjust the treble.	-06 (min.) +06 (max.)
FAD*	Adjust the front and rear speaker balance.	R06 (Rear only) F06 (Front only)
BAL	Adjust the left and right speaker balance.	L06 (Left only) R06 (Right only)
LOUD	Boost low and high frequencies to produce a well-balanced sound at low volume level.	LOUD ON LOUD OFF
VOL	Adjust the volume.	00 (min.) 50 (max.)

* If you are using a two-speaker system, set the fader level to "00."



Using the sound control memory

You can select and store a preset sound adjustment suitable for each playback source (**Advanced SCM**).

Selecting and storing the sound modes

Once you select a sound mode, it is stored in memory. It will be recalled every time you select the same source and will be shown on the display. A sound mode can be stored for each of the following sources — FM1, FM2, FM3, AM, tape and external components.

- If you do not want to store the sound mode separately for each playback source, but want to use the same sound mode for all the sources, see “To cancel Advanced SCM – SCM LINK” on page 24.

Select the sound mode you want.

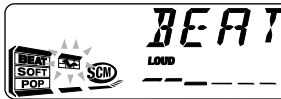

Ex.: When you select “BEAT”

Each time you press the button, the sound mode changes as follows:

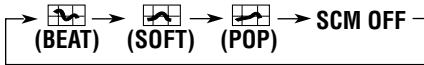

- When “SCM LINK” is set to “LINK ON,” the selected sound mode can be stored in memory for the current source and the effect applies only to the current source. Each time you change the playback source, the SCM indicator flashes on the display.
- When “SCM LINK” is set to “LINK OFF,” the selected sound mode effect applies to any source.

Indication	For:	Preset values		
		BAS	TRE	LOUD
BEAT	Rock or disco music	+02	00	ON
SOFT	Quiet background music	+01	-03	OFF
POP	Light music	+04	+01	OFF
SCM OFF	(Flat sound)	00	00	ON

Recalling the sound modes

When “SCM LINK” is set to “LINK ON,” select the source.

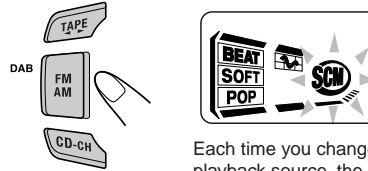

Each time you change the playback source, the SCM indicator flashes on the display.

The sound mode stored in memory for the selected source is recalled.

Notes:

- You can adjust each sound mode to your preference, and store it in memory. If you want to adjust and store your original sound mode, see “Storing your own sound adjustments” on page 21.
- To adjust the bass and treble reinforcement levels or to turn on/off the loudness function temporarily, see page 19. (Your adjustments will be canceled if another source is selected.)



Storing your own sound adjustments

You can adjust the sound modes (BEAT, SOFT, POP) to your preference and store your own adjustments in memory.

- There is a time limit in doing the following procedure. If the setting is canceled before you finish, start from step 1 again.

1 Call up the sound mode you want to adjust.

- See page 20 for details.

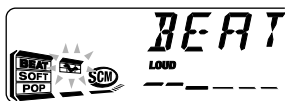

Ex.: When you select "BEAT"

4 Repeat steps 2 and 3 to adjust the other items.

5 Press and hold SCM until the sound mode you have selected in step 1 flashes on the display.



Your adjustment made for the selected sound mode is stored in memory.

6 Repeat the same procedure to store other sound modes.

To reset to the factory settings

Repeat the same procedure and reassign the preset values listed in the table on page 20.

2 Select "BAS" (bass), "TRE" (treble) or "LOUD" (loudness).



Ex.: When you adjust "TRE" (treble)

3 Adjust the bass or treble level or turn the loudness function ON/OFF.

- See page 19 for details.

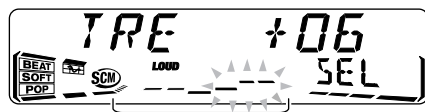

Equalization pattern changes as you adjust the bass or treble.

Setting the clock

You can also set the clock system to either 24 hours or 12 hours.

- 1 Press and hold SEL (select) for more than 2 seconds so that one of the PSM items appears on the display. (See page 23.)



- 2 Set the hour.

- 1 Select "CLOCK H" if not shown on the display.
- 2 Adjust the hour.

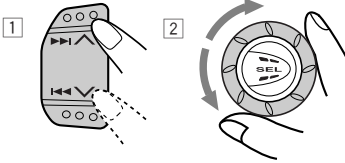

- 3 Set the minute.

- 1 Select "CLOCK M."
- 2 Adjust the minute.

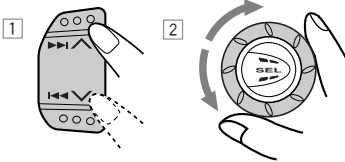

- 4 Set the clock system.

- 1 Select "24H/12H."
- 2 Select "24H" or "12H."

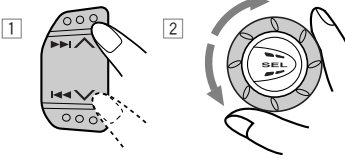

- 5 Press SEL (select) to finish the setting.



To check the current clock time while the unit is turned off, press DISP (display).

The power turns on, the clock time is shown for 5 seconds, then the power turns off.

Changing the general settings (PSM)

You can change the items listed on the next page by using the PSM (Preferred Setting Mode) control.

Basic Procedure

- 1 Press and hold SEL (select) for more than 2 seconds so that one of the PSM items appears on the display. (See page 23.)



- 2 Select the PSM item you want to adjust. (See page 23.)



- 3 Adjust the PSM item selected.





- 4 Repeat steps 2 and 3 to adjust the other PSM items if necessary.

- 5 Press SEL (select) to finish the setting.

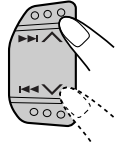

Preferred Setting Mode (PSM) items

1  Hold.	2  Select.	3  Set. Counter-clockwise Clockwise		Factory-preset settings	See page
CLOCK H	Hour adjustment	Back	Advance	0:00	22
CLOCK M	Minute adjustment	Back	Advance		
SCM LINK	Sound control memory linkage	LINK OFF	LINK ON	LINK ON	20, 24
24H/12H	24/12-hour time display	12H	24H	24H	22
AUTO ADJ	Automatic clock setting	OFF	ON	ON	14
CLOCK	Clock display	OFF	ON	ON	24
TU DISP	Tuner display	FREQ	PS NAME	PS NAME	14
PTY STBY	PTY standby	29 programme types (see pages 12 and 15.)		NEWS	12
PTY SRCH	PTY search			(See page 12.)	12
TA VOL	Traffic announcement volume	VOL 00 – VOL 50		VOL 20	14
P-SEARCH	Programme search	OFF	ON	OFF	13
DAB AF*	Alternative frequency search	AF OFF	AF ON	AF ON	32
LEVEL	Level display	AUDIO 1 ↙	↔ AUDIO 2 ↘ OFF	AUDIO 2	24
DIMMER**	Dimmer mode	AUTO ↙	↔ OFF ↘ ON	AUTO	24
TEL	Telephone muting	MUTING 1 ↙	↔ MUTING 2 ↘ OFF	OFF	24
BEEP**	Key-touch tone	OFF	ON	ON	24
B. SKIP	Blank skip	OFF	ON	OFF	18
EXT IN***	External component	CHANGER	LINE IN	CHANGER	24, 28

- Press SEL (select) to finish the setting.

* Displayed only when the DAB tuner is connected.

** These functions are applicable only to KS-FX922R.

*** Displayed only when one of the following sources is selected – FM, AM and Tape.

To cancel Advanced SCM – SCM LINK

You can cancel the Advanced SCM (Sound Control Memory), and unlink the sound modes and the playback sources.

When shipped from the factory, a different sound mode can be stored in memory for each source so that you can change the sound modes simply by changing the sources.

- **LINK ON:** Advanced SCM (different sound modes for different sources).
- **LINK OFF:** Conventional SCM (one sound mode for all sources).

To set the clock display – CLOCK

You can set the clock to be shown on the display when the unit is turned on.

When shipped from the factory, the clock is set to be shown on the display.

- **ON:** Clock display is turned on.
- **OFF:** Clock display is turned off. When “OFF” is selected, the current source name or station band appears instead of the clock display (except when “EXT-LINE IN” is selected as the source).

To select the level meter – LEVEL

You can select the level display according to your preference.

When shipped from the factory, “AUDIO 2” is selected.

- **AUDIO 1:** Level meter illuminates from bottom to top.
- **AUDIO 2:** Alternates level meter (moves from bottom to top) and illumination display.
- **OFF:** Erases the audio level indicator.

To select the dimmer mode – DIMMER (Only for KS-FX922R)

When you turn on the car head lights, the display automatically dims (Auto Dimmer).

When shipped from the factory, Auto Dimmer mode is activated.

- **AUTO:** Activates Auto Dimmer.
- **OFF:** Cancels Auto Dimmer.
- **ON:** Always dims the display.

Note:

Auto Dimmer equipped with this unit may not work correctly on some vehicles, particularly on those having a control dial for dimming.

In this case, set the dimmer mode to “ON” or “OFF.”

To select the telephone muting – TEL

This mode is used when a cellular phone system is connected. Depending on the phone system used, select either “MUTING 1” or “MUTING 2,” whichever mutes the sounds from this unit.

When shipped from the factory, this mode is deactivated.

- **MUTING 1:** Select this if this setting can mute the sounds.
- **MUTING 2:** Select this if this setting can mute the sounds.
- **OFF:** Cancels the telephone muting.

To turn on/off the key-touch tone – BEEP (Only for KS-FX922R)

You can deactivate the key-touch tone if you do not want it to beep each time you press a button. When shipped from the factory, the key-touch tone is activated.

- **ON:** Activates the key-touch tone.
- **OFF:** Deactivates the key-touch tone.

To select the external component to use – EXT IN

You can connect the external component to the CD changer jack on the rear using the Line Input Adaptor KS-U57 (not supplied).

To use the external component as the playback source through this unit, you need to select which component – CD changer or external component – to use.

When shipped from the factory, CD changer is selected as the external component.

- **LINE IN:** To use the external component other than CD changer.
- **CHANGER:** To use the CD changer.

Note:

For connecting the Line Input Adaptor KS-U57 and the external component, refer to the Installation/Connection Manual (separate volume).

Detaching the control panel

You can detach the control panel when leaving the car.

When detaching or attaching the control panel, be careful not to damage the connectors on the back of the control panel and on the panel holder.

Detaching the control panel

Before detaching the control panel, be sure to turn off the power.

1 Unlock the control panel.

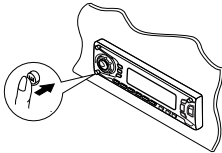

2 Pull the control panel out of the unit.

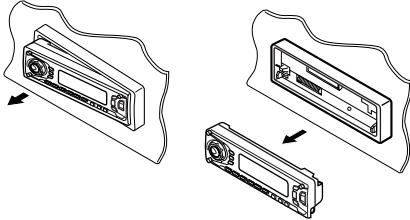

3 Put the detached control panel into the provided case.

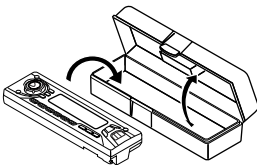

Attaching the control panel

1 Insert the right side of the control panel into the groove on the panel holder.

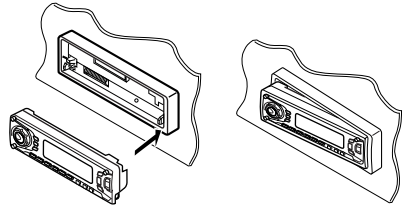

2 Press the left side of the control panel to fix it to the panel holder.

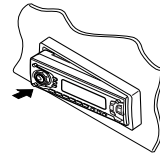

Note on cleaning the connectors:

If you frequently detach the control panel, the connectors will deteriorate.

To minimize this possibility, periodically wipe the connectors with a cotton swab or cloth moistened with alcohol, being careful not to damage the connectors.

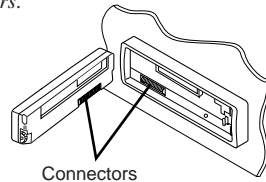



CD CHANGER OPERATIONS

ENGLISH

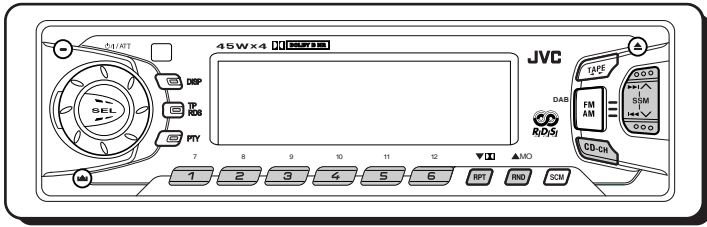

We recommend that you use one of the CH-X series with your unit.

If you have another CD automatic changer, consult your JVC IN-CAR ENTERTAINMENT dealer for connections.

- For example, if your CD automatic changer is one of the KD-MK series, you need a cord (KS-U15K) for connecting it to this unit.

Before operating your CD automatic changer:

- Refer also to the Instructions supplied with your CD changer.
- If no discs are in the magazine of the CD changer or the discs are inserted upside down, "NO DISC" will appear on the display. If this happens, remove the magazine and set the discs correctly.
- If "RESET 1" – "RESET 8" appears on the display, something is wrong with the connection between this unit and the CD changer. If this happens, check the connection and make sure the cords are connected firmly. Then, press the reset button of the CD changer.

Playing CDs

Select the CD automatic changer (CD-CH).



Playback starts from the first track of the first disc.
All tracks of all discs are played back.

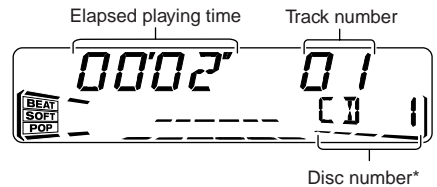

- * When "CLOCK" is set to "ON" (see page 24), disc number will soon change to clock time.

Note on One-Touch Operation:

When you press CD-CH, the power automatically turns on. You do not have to press /WATT to turn on the power.

To fast-forward or reverse the track

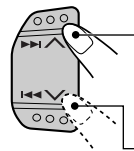

Press and hold , while playing a CD, to fast-forward the track.

Press and hold , while playing a CD, to reverse the track.

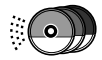

To go to the next track or the previous tracks

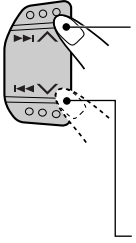

Press **▶▶| ^** briefly, while playing a CD, to go ahead to the beginning of the next track. Each time you press the button consecutively, the beginning of the next track is located and played back.

Press **|◀◀ v** briefly, while playing a CD, to go back to the beginning of the current track. Each time you press the button consecutively, the beginning of the previous tracks is located and played back.

To go to a particular disc directly

Press the number button corresponding to the disc number to start its playback (while the CD changer is playing).

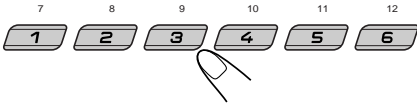

- To select a disc number from 1 – 6: Press 1 (7) – 6 (12) briefly.
- To select a disc number from 7 – 12: Press and hold 1 (7) – 6 (12) for more than 1 second.

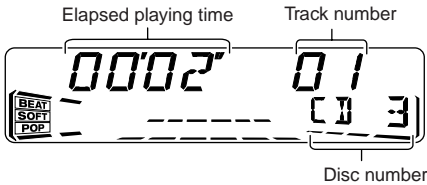

Ex.: When disc number 3 is selected

Selecting CD playback modes

To play back tracks at random (Random Play)



Each time you press RND MO (random/monaural), CD random play mode changes as follows:



Mode	RND Indicator	Plays at random
RND1	Lights	All tracks of the current disc, then the tracks of the next disc and so on.
RND2	Flashes	All tracks of all discs inserted in the magazine.

To play back tracks repeatedly (Repeat Play)



Each time you press RPT **□□** (repeat/Dolby B), CD repeat play mode changes as follows:



Mode	RPT Indicator	Plays repeatedly
RPT1	Lights	The current track (or specified track).
RPT2	Flashes	All tracks of the current disc (or specified disc).



EXTERNAL COMPONENT OPERATIONS

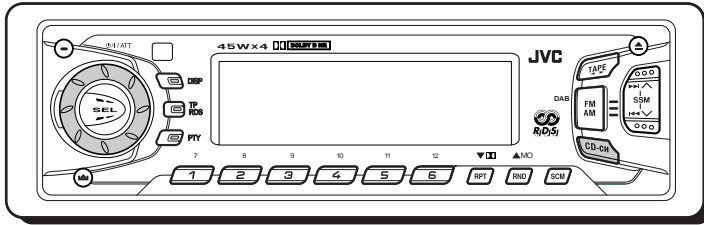

Playing an external component

You can connect the external component to the CD changer jack on the rear using the Line Input Adaptor KS-U57 (not supplied).

Preparations:

- For connecting the Line Input Adaptor KS-U57 and the external component, refer to the Installation/ Connection Manual (separate volume).
- Before operating the external component using the following procedure, select the external input correctly. (See "To select the external component to use – EXT IN" on page 24.)

2 Turn on the connected component and start playing the source.

3 Adjust the volume.



4 Adjust the sound characteristics you want. (See page 19.)

1 Select the external component (CD-CH).



- If "LINE IN" does not appear on the display, see page 24 and select the external input ("LINE IN").
- Displayed only when one of the following sources is selected – FM, AM and Tape.

Note on One-Touch Operation:

When you press CD-CH, the power automatically comes on. You do not have to press /WATT to turn on the power.

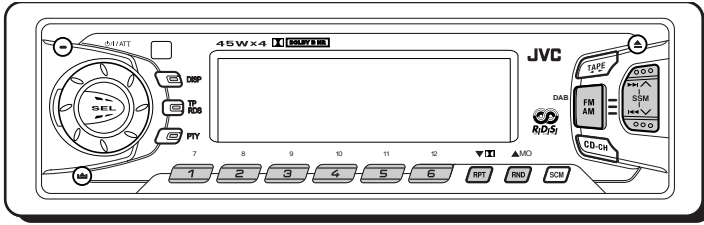

We recommend that you use DAB (Digital Audio Broadcasting) tuner KT-DB1500 with your unit. If you have another DAB tuner, consult your JVC IN-CAR ENTERTAINMENT dealer.

- Refer also to the Instructions supplied with your DAB tuner.

What is DAB system?

DAB is one of the digital radio broadcasting systems available today. It can deliver CD quality sound without any annoying interference and signal distortion. Furthermore, it can carry text, pictures and data.

In contrast to FM broadcast, where each programme is transmitted on its own frequency, DAB combines several programmes (called “services”) to form one “ensemble.”

With the DAB tuner connected with this unit, you can enjoy these DAB services.

Tuning into an ensemble and one of the services

A typical ensemble has 6 or more programmes (services) broadcast at the same time. After tuning into an ensemble, you can select a service you want to listen to.

Before you start....

Press DAB (FM AM) briefly if tape, CD changer or external component is the current source.

1 Select the DAB tuner.



Each time you press and hold the button, the DAB tuner and the FM/AM tuner are alternately selected.

DAB ↔ FM/AM

2 Select the DAB band (DAB1, DAB2 or DAB3).



Each time you press the button, the DAB band changes as follows:

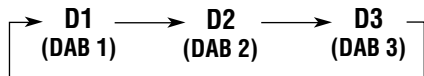

Note:

This receiver has three DAB bands (DAB1, DAB2, DAB3). You can use any one of them to tune into an ensemble.

3 Start searching an ensemble.

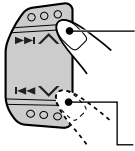

Press ►► ▲ to search ensembles of higher frequencies.

Press ◄◄ ▼ to search ensembles of lower frequencies.

When an ensemble is received, searching stops.

To stop searching before an ensemble is received, press the same button you have pressed for searching.

4 Select a service you want to listen to.



Press ▲ (RND MO) to select the next service.



Press ▼ (RPT ◻) to select the previous service.

To change the display information while tuning into an ensemble

Normally service name is shown on the display. If you want to change the display information, press DISP.

Each time you press the button, the following information appears on the display for a while.

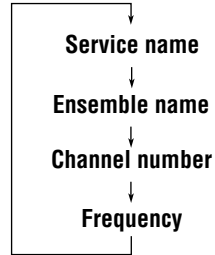

To tune into a particular ensemble without searching:

- 1 Press and hold DAB (FM AM) to select DAB tuner as the source.
- 2 Press DAB (FM AM) repeatedly to select the DAB band (DAB1, DAB2 or DAB3).
- 3 Press and hold ►► ▲ or ◄◄ ▼ for more than 1 second.
- 4 Press ►► ▲ or ◄◄ ▼ repeatedly until the ensemble you want is reached.
 - If you hold down the button, the frequency keeps changing until you release the button.

To restore the FM/AM tuner

Press and hold DAB (FM AM) again.

Storing DAB services in memory

You can preset up to 6 DAB services in each DAB band (DAB1, DAB2 and DAB3) manually.

1 Select the DAB tuner.

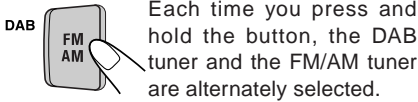

DAB ↔ FM/AM

2 Select the DAB band (DAB1, DAB2 or DAB3) you want.

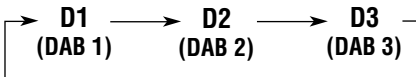
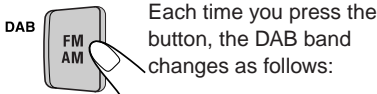

3 Tune into an ensemble you want.

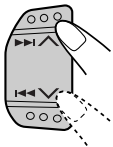

4 Select a service of the ensemble you want.



Press ▲ (RND MO) to select the next service.



Press ▼ (RPT ▢) to select the previous service.

5 Press and hold the number button (in this example, 1) you want to store the selected service into for more than 2 seconds.

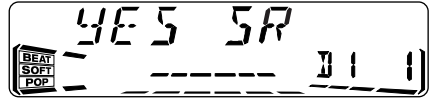

Selected band/preset number and "MEMO" (memory) appear alternately for a while.

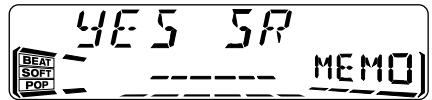

6 Repeat the above procedure to store other DAB services into other preset numbers.

Notes:

- A previously preset DAB service is erased when a new DAB service is stored in the same preset number.
- Preset DAB services are erased when the power supply to the memory circuit is interrupted (for example, during battery replacement). If this occurs, preset the DAB services again.

Tuning into a preset DAB service

You can easily tune into a preset DAB service. Remember that you must store services first. If you have not stored them yet, see page 31.

1 Select the DAB tuner.

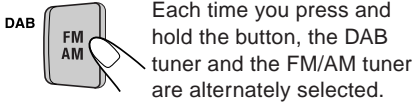

DAB ↔ FM/AM

2 Select the DAB band (DAB1, DAB2 or DAB3) you want.

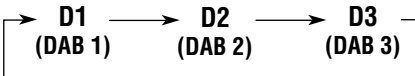
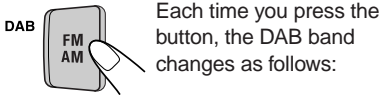

3 Select the number (1 – 6) for the preset DAB service you want.

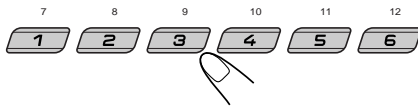

What you can do more with DAB

Tracing the same program automatically (Alternative Reception)

You can keep listening to the same program.

- **While receiving a DAB service:**

When driving in an area where a service cannot be received, this unit automatically tunes into another ensemble or FM RDS station, broadcasting the same program.

- **While receiving an FM RDS station:**

When driving in an area where a DAB service is broadcasting the same program as the FM RDS station is broadcasting, this unit automatically tunes into the DAB service.

Note:

When reception switches between DAB and FM, the listening volume level may increase or decrease inconveniently. This change in the volume level results from unequal audio injection levels at broadcaster site, but not from the malfunction of this unit.

To use Alternative Reception

When shipped from the factory, Alternative Reception is activated.

- 1 Press and hold SEL (select) for more than 2 seconds so that one of the PSM items appears on the display.
- 2 Press ►| ▲ or ◀| ▼ to select “DAB AF” (alternative frequency).
- 3 Turn the control dial to select the desired mode.
 - AF ON: Traces the program among DAB services and FM RDS stations — Alternative Reception. The AF indicator lights up on the display (see page 10).
 - AF OFF: Deactivates Alternative Reception.

Note:

When Alternative Reception (for DAB services) is activated, Network-Tracking Reception (for RDS stations: see page 10) is also activated automatically. On the other hand, Network-Tracking Reception cannot be deactivated without deactivating Alternative Reception.

- 4 Press SEL (select) to finish the setting.



This unit requires very little attention, but you will be able to extend the life of the unit if you follow the instructions below.

To clean the heads

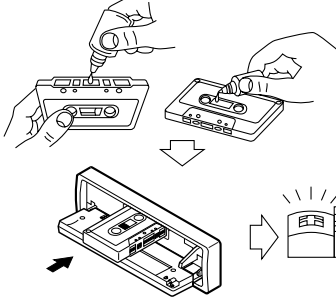

- Clean the heads after every 10 hours of use using a wet-type head cleaning tape (available at an audio store).
When the head becomes dirty, you may realize the following symptoms:
 - Sound quality is reduced.
 - Sound level decreases.
 - Sound drops out.
- Do not play dirty or dusty tapes.
- Do not touch the highly-polished head with any metallic or magnetic tools.

To keep the tape clean

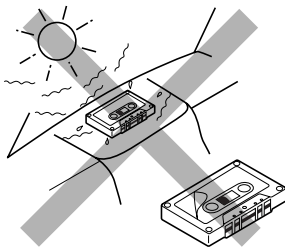

- Always store the cassettes to their storage cases after use.
- Do not store cassettes in the following places:
 - Subject to direct sunlight
 - With high humidity
 - At extremely hot temperatures

CAUTION:

- *Do not play the cassettes with peeling labels; otherwise, they can damage the unit.*
- *Tighten tapes to remove slack since loose tape may become entangled with the mechanism.*
- *Do not leave a cassette in the cassette compartment after use, as the tape may become slack.*

The function below is also provided to ensure the longer life of this unit.

Ignition key-off release/ Ignition key-on play

- Turning off the ignition key with a cassette in the compartment automatically releases the tape from the unit's tapehead.
- Turning on the ignition key with a cassette in the compartment starts playback automatically if you turned off the ignition during tape play.



TROUBLESHOOTING

What appears to be trouble is not always serious. Check the following points before calling a service center.

Symptoms	Causes	Remedies
• A cassette tape cannot be inserted.	You have tried to insert a cassette in the wrong way.	Insert the cassette with the exposed tape facing right.
• A cassette tape cannot be ejected.	Cassette ejection is prohibited.	Press and hold TAPE ◀▶ and ⏻/ATT for more than two seconds.
• Cassette tapes become hot.	This is not a malfunction.	_____
• Tape sound is at very low level and sound quality is degraded.	The tape head is dirty.	Clean it with a head cleaning tape.
• Sound is sometimes interrupted.	Connections are not good.	Check the cords and connections.
• Sound cannot be heard from the speakers.	The volume is turned to the minimum level.	Adjust it to the optimum level.
	Connections are incorrect.	Check the cords and connections.
• SSM (Strong-station Sequential Memory) automatic preset does not work.	Signals are too weak.	Store stations manually.
• Static noise while listening to the radio.	The antenna is not connected firmly.	Connect the antenna firmly.
• "NO DISC" appears on the display.	No CD is in the magazine.	Insert CDs into the magazine.
	CDs are inserted incorrectly.	Insert them correctly.
• "NO MAG" appears on the display.	No magazine is loaded in the CD changer.	Insert the magazine.
• "RESET 8" appears on the display.	This unit is not connected to a CD changer correctly.	Connect this unit and the CD changer correctly and press the reset button of the CD changer.
• "RESET 1" – "RESET 7" appears on the display.	_____	Press the reset button of the CD changer.
• This unit does not work at all. • The CD changer does not work at all.	The built-in microcomputer may function incorrectly due to noise, etc.	Press the reset button on the panel holder. (The clock setting and preset stations stored in memory are erased.) (See page 2.)

AUDIO AMPLIFIER SECTION

Maximum Power Output:

Front: 45 W per channel

Rear: 45 W per channel

Continuous Power Output (RMS):

Front: 17 W per channel into 4 Ω , 40 Hz to 20 000 Hz at no more than 0.8% total harmonic distortion.

Rear: 17 W per channel into 4 Ω , 40 Hz to 20 000 Hz at no more than 0.8% total harmonic distortion.

Load Impedance: 4 Ω (4 Ω to 8 Ω allowance)

Tone Control Range:

Bass: ± 10 dB at 100 Hz

Treble: ± 10 dB at 10 kHz

Frequency Response: 40 Hz to 20 000 Hz

Signal-to-Noise Ratio: 70 dB

Line-Out Level/Impedance:

2.0 V/20 k Ω load (250 nWb/m)

TUNER SECTION

Frequency Range:

FM: 87.5 MHz to 108.0 MHz

AM: (MW) 522 kHz to 1 620 kHz
(LW) 144 kHz to 279 kHz

[FM Tuner]

Usable Sensitivity: 11.3 dBf (1.0 μ V/75 Ω)

50 dB Quietening Sensitivity:

16.3 dBf (1.8 μ V/75 Ω)

Alternate Channel Selectivity (400 kHz):

65 dB

Frequency Response: 40 Hz to 15 000 Hz

Stereo Separation: 30 dB

Capture Ratio: 1.5 dB

[MW Tuner]

Sensitivity: 20 μ V

Selectivity: 35 dB

[LW Tuner]

Sensitivity: 50 μ V

CASSETTE DECK SECTION

Wow & Flutter: 0.11% (WRMS)

Fast-Wind Time: 100 sec. (C-60)

Frequency Response (Dolby B NR OFF):

30 Hz to 16 000 Hz (Normal tape)

Signal-to-Noise Ratio: (Normal tape)

(Dolby B NR ON): 65 dB

(Dolby B NR OFF): 56 dB

Stereo Separation: 40 dB

GENERAL

Power Requirement:

Operating Voltage: DC 14.4 V

(11 V to 16 V allowance)

Grounding System: Negative ground

Allowable Operating Temperature: 0°C to +40°C

Dimensions (W \times H \times D):

Installation Size: 182 mm \times 52 mm \times 150 mm

Panel Size: 188 mm \times 58 mm \times 14 mm

Mass: 1.4 kg (excluding accessories)

Design and specifications subject to change without notice.

Having TROUBLE with operation?

Please reset your unit

Refer to page of How to reset your unit

Haben Sie PROBLEME mit dem Betrieb?

Bitte setzen Sie Ihr Gerät zurück

Siehe Seite Zurücksetzen des Geräts

Vous avez des PROBLÈMES de fonctionnement?

Réinitialisez votre appareil

Référez-vous à la page intitulée Comment réinitialiser votre appareil

Hebt u PROBLEMEN met de bediening?

Stel het apparaat terug

Zie de pagina met de paragraaf Het apparaat terugstellen

JVC

VICTOR COMPANY OF JAPAN, LIMITED

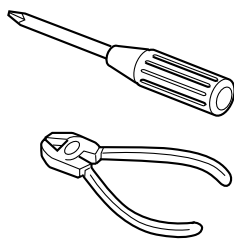

ENGLISH

- This unit is designed to operate on 12 V DC, NEGATIVE ground electrical systems.

INSTALLATION (IN-DASH MOUNTING)

- The following illustration shows a typical installation. However, you should make adjustments corresponding to your specific car. If you have any questions or require information regarding installation kits, consult your JVC IN-CAR ENTERTAINMENT dealer or a company supplying kits.

1 Before mounting: Press (Control Panel Release button) to detach the control panel if already attached.

* When shipped from the factory, the control panel is packed in the hard case.

2 Remove the trim plate.

3 Remove the sleeve after disengaging the sleeve locks.

① Stand the unit.

Note: When you stand the unit, be careful not to damage the fuse on the rear.

② Insert the 2 handles between the unit and the sleeve, as illustrated, to disengage the sleeve locks.

③ Remove the sleeve.

Note: Be sure to keep the handles for future use after installing the unit.

4 Install the sleeve into the dashboard.

* After the sleeve is correctly installed into the dashboard, bend the appropriate tabs to hold the sleeve firmly in place, as illustrated.

5 Fix the mounting bolt to the rear of the unit's body and place the rubber cushion over the end of the bolt.

6 Do the required electrical connections.

7 Slide the unit into the sleeve until it is locked.

8 Attach the trim plate so that the projection on the trim plate is fixed to the left side of the unit.

9 Attach the control panel.

DEUTSCH

- Dieses Gerät ist für einen Betrieb in elektrischen Anlagen mit 12 V Gleichstrom und (-) Erdung ausgelegt.

EINBAU (IM ARMATURENBRETT)

- Die folgende Abbildung zeigt einen typischen Einbau. Dennoch müssen Sie entsprechend Ihrem jeweiligen Auto Anpassungen vornehmen. Bei irgendwelchen Fragen oder wenn Sie Informationen hinsichtlich des Einbausatzes brauchen, wenden Sie sich an ihren JVC Autoradiohändler oder ein Unternehmen das diese Einbausätze vertreibt.

1 Vor dem Einbau: Drücken Sie (Freigabe der Bedienungsblende), um die Arretierung der Bedienungsblende zu lösen, sofern diese bereits angebracht ist.

* Bei der Auslieferung ab Werk ist die Bedienungsblende im Etui verpackt.

2 Den Frontrahmen herausnehmen.

3 Die Halterung nach dem Entriegeln der Halterungssperren abnehmen.

① Das Gerät aufstellen.

Hinweis: Beim Aufstellen des Geräts darauf achten, daß die Sicherung auf der Rückseite nicht beschädigt wird.

② Die 2 Griffe zwischen dem Gerät und der Halterung wie abgebildet einstecken und die Halterungssperren entriegeln.

③ Die Halterung entfernen.

Hinweis: Sicherstellen, daß die Griffe für künftigen Gebrauch nach dem Einbau des Geräts aufbewahrt werden.

4 Die Halterung im Armaturenbrett einbauen.

* Nach dem korrekten Einbau der Halterung im Armaturenbrett, die entsprechenden Riegel umknicken, um die Halterung an ihrem Platz zu sichern, siehe Abbildung.

5 Die Befestigungsschraube an der Rückseite des Gerätekörpers befestigen und das Ende der Schraube mit einem Gummipuffer abdecken.

6 Nehmen Sie die erforderlichen elektrischen Anschlüsse vor.

7 Das Gerät in die Halterung schieben, bis es einrastet.

8 Befestigen Sie die Frontrahmen in der Form, daß der Fortsatz der Frontrahmen auf der linken Seite des Geräts befestigt wird.

9 Die Schalttafel anbringen.

FRANÇAIS

- Cet appareil est conçu pour fonctionner sur des sources de courant continu de 12 V à masse NEGATIVE.

INSTALLATION (MONTAGE DANS LE TABLEAU DE BORD)

- L'illustration suivante est un exemple d'installation typique. Cependant, vous devez faire les ajustements correspondant à votre voiture particulière. Si vous avez des questions ou avez besoin d'information sur des kits d'installation, consulter votre revendeur d'autoradios JVC ou une compagnie d'approvisionnement.

1 Avant le montage: Appuyer sur (débloccage du panneau de commande) pour éventuellement détacher le panneau de commande.

* Lorsque ce panneau de commande sort d'usine, il est rangé dans un étui de transport.

2 Retirer la plaque d'assemblage.

3 Libérer les verrous du manchon et retirer le manchon.

① Poser l'appareil à la verticale.

Remarque: Lorsque vous mettez l'appareil à la verticale, faire attention de ne pas endommager le fusible situé sur l'arrière.

② Insérer les 2 poignées entre l'appareil et le manchon comme indiqué pour désengager les verrous de manchon.

③ Retirer le manchon.

Remarque: S'assurer de garder les poignées pour une utilisation ultérieure, après l'installation de l'appareil.

4 Installer le manchon dans le tableau de bord.

* Après installation correcte du manchon dans le tableau de bord, plier les bonnes pattes pour maintenir fermement le manchon en place, comme montré.

5 Monter le boulon de montage sur l'arrière du corps de l'appareil puis passer l'amortisseur en caoutchouc sur l'extrémité du boulon.

6 Réaliser les connexions électriques.

7 Faire glisser l'appareil dans le manchon jusqu'à ce qu'il soit verrouillé.

8 Attachez la plaque d'assemblage de façon que la projection de la plaque d'assemblage soit fixée sur le côté gauche de l'appareil.

9 Remonter le panneau de commande.

NEDERLANDS

- Dit apparaat mag worden gebruikt bij elektrische systemen die werken op 12 V gelijkstroom met negatieve aarding.

INSTALLATIE (INBOUW IN HET DASHBOARD)

- Op de volgende afbeelding kunt u zien hoe de installatie, normaal gesproken, in zijn werk gaat. U moet echter bij de installatie rekening houden met de bijzonderheden van uw eigen auto. Neem bij vragen of voor meer bijzonderheden over inbouwpakketten contact op met uw JVC car audio dealer of een dealer of een bedrijf dat inbouwpakketten levert.

1 Voordat u aan de montage van het apparaat begint: Druk op (het bedieningspaneel vrijgeven) als u het bedieningspaneel wilt loskoppelen indien dit aan de eenheid is vastgekoppeld.

* Standaard wordt het bedieningspaneel bij het verlaten van de fabriek los verpakt meegeleverd.

2 Verwijder de sierplaat.

3 Verwijder het huis nadat u de klemmen hebt losgemaakt.

① Zet het apparaat rechtop.

Opmerking: Wanneer u het apparaat rechtop zet, moet u erop letten dat u de zekering aan de achterkant niet beschadigt.

② Plaats de 2 hendels, zoals afgebeeld, tussen het apparaat en het huis, om de klemmen los te maken.

③ Verwijder het huis.

Opmerking: Bewaar de hendels nadat u het apparaat hebt geïnstalleerd, zodat u ze ook in de toekomst kunt gebruiken.

4 Installeer het huis in het dashboard.

* Nadat het huis op de juiste wijze in het dashboard is geplaatst, moet u de palletjes, zoals afgebeeld, stevig op hun plaats duwen.

5 Maak de bevestigingsbout aan de achterkant van het apparaat vast en plaats de rubberdop over het uiteinde van de bout.

6 Breng de vereiste elektrische verbindingen tot stand.

7 Schuif het apparaat in het huis totdat het vergrendeld is.

8 Bevestig de sierplaat zodanig dat het uitstekende deel van de plaat aan de linkerkant van de eenheid vast komt te zitten.

9 Bevestig het bedieningspaneel.

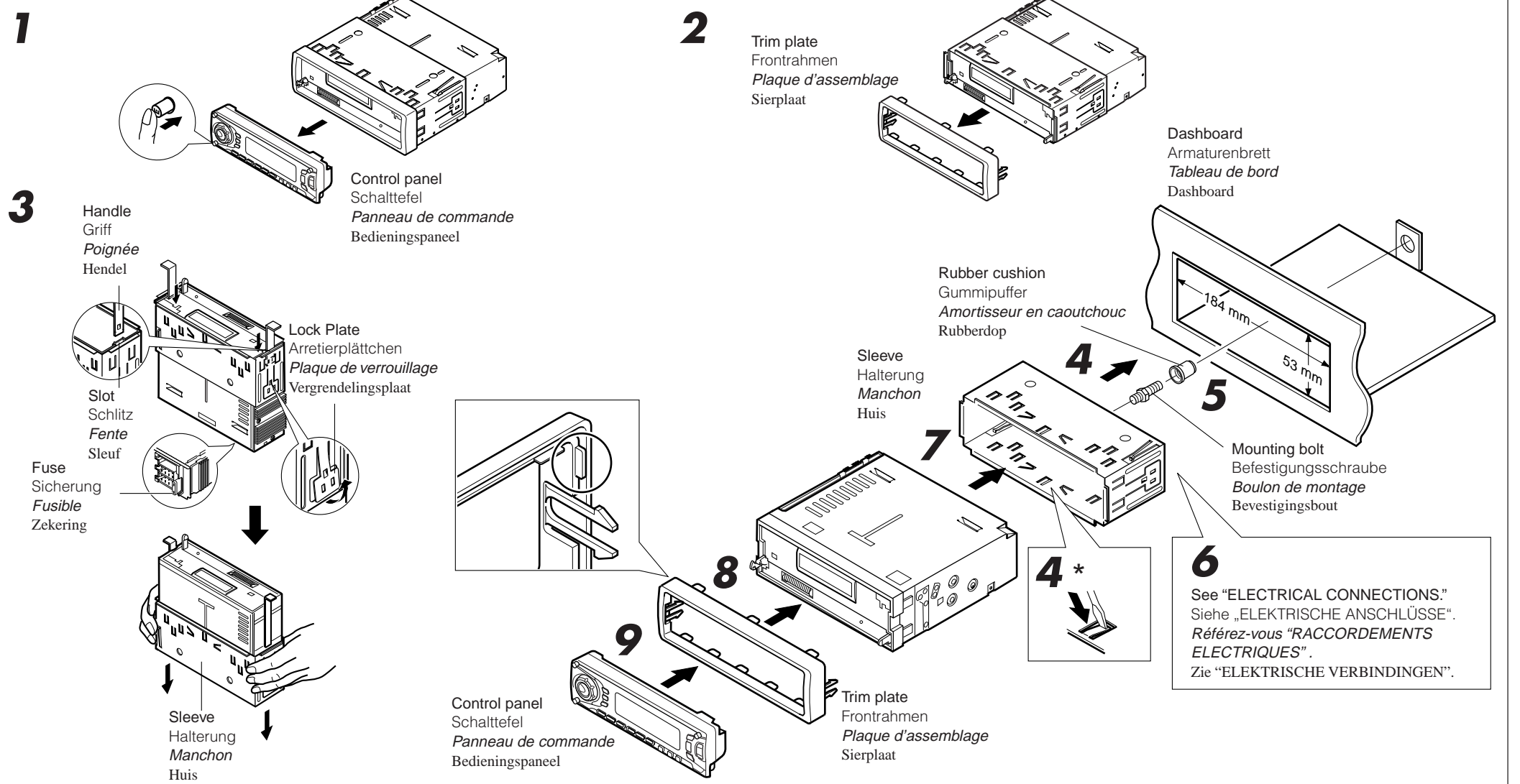

- When using the optional stay
- Beim Verwenden der Anker-Option
- Lors de l'utilisation du hauban en option
- Wanneer u de steun gebruikt (facultatief)

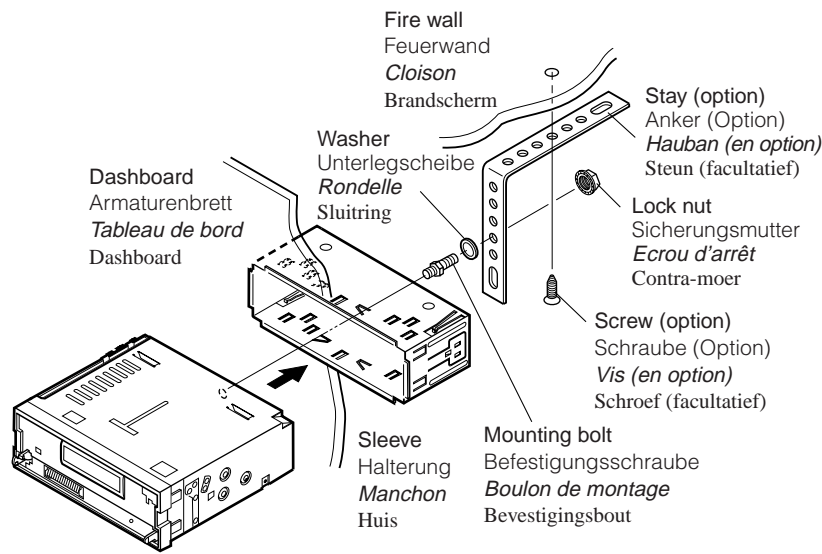

- When installing the unit without using the sleeve
- Beim Einbau des Geräts ohne Halterung
- Lors de l'installation de l'appareil sans utiliser de manchon
- Wanneer u het apparaat zonder huis installeert

In a Toyota for example, first remove the car radio and install the unit in its place.
Zum Beispiel in einem Toyota zuerst das Autoradio ausbauen und dann das Gerät an seinem Platz einbauen.
Par exemple dans un Toyota, retirer d'abord l'autoradio et installer l'appareil à la place.
Voorbeeld: Bij een Toyota moet u eerst de autoradio verwijderen en daarna het apparaat installeren.

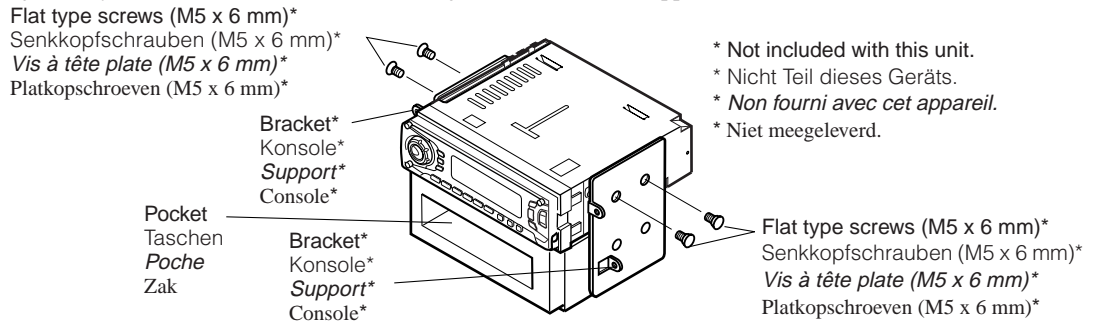

- * Not included with this unit.
- * Nicht Teil dieses Geräts.
- * Non fourni avec cet appareil.
- * Niet meegeleverd.

Note: When installing the unit on the mounting bracket, make sure to use the 6 mm-long screws. If longer screws are used, they could damage the unit.

Hinweis: Beim Anbringen des Gerät an der Konsole sicherstellen, daß 6 mm lange Schrauben verwendet werden. Werden längere Schrauben verwendet, können sie das Gerät beschädigen.

Remarque: Lors de l'installation de l'appareil sur le support de montage, s'assurer d'utiliser des vis d'une longueur de 6 mm. Si des vis plus longues sont utilisées, elles peuvent endommager l'appareil.

Opmerking: Wanneer u het apparaat aan de bevestigingsklem vastmaakt, moet u de 6 mm lange schroeven gebruiken. Als u langere schroeven gebruikt, kan het apparaat worden beschadigd.

Removing the unit

• Before removing the unit, release the rear section.

- 1 Remove the control panel.
- 2 Remove the trim plate.
- 3 Insert the 2 handles into the slots, as shown. Then, while gently pulling the handles away from each other, slide out the unit. **(Be sure to keep the handles after installing it.)**

Ausbau des Geräts

• Vor dem Ausbau des Geräts den hinteren Teil freigeben.

- 1 Den Schalttafel abnehmen.
- 2 Den Frontrahmen herausnehmen.
- 3 Die 2 Griffe in die Schlitzte wie gezeigt stecken. Dann die Griffe behutsam auseinander ziehen und das Gerät herausziehen. **(Die Griffe nach dem Einbau auf jeden Fall aufbewahren.)**

Retrait de l'appareil

• Avant de retirer l'appareil, libérer la section arrière.

- 1 Retirer le panneau de commande.
- 2 Retirer la plaque d'assemblage.
- 3 Introduire les 2 poignées dans les fentes, comme montré. Puis, tout en tirant doucement les poignées écartées, faire glisser l'appareil pour le sortir. **(S'assurer de conserver les poignées après l'installation de l'appareil.)**

Verwijderen van het apparaat

• Voordat u het apparaat verwijdert, moet u het achtergedeelte losmaken.

- 1 Verwijder het bedieningspaneel.
- 2 Verwijder de sierplaat.
- 3 Plaats de 2 hendels, zoals afgebeeld, in de sleuven. Daarna duwt u de hendels zachtjes uit elkaar en kunt u het apparaat naar buiten schuiven. **(Bewaar de hendels nadat u het apparaat hebt geïnstalleerd!)**

1

Control panel
Schalttafel
Panneau de commande
Bedieningspaneel

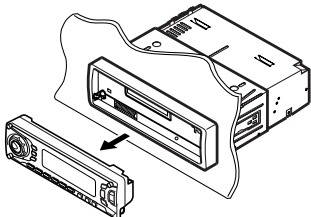

2

Trim plate
Frontrahmen
Plaque d'assemblage
Sierplaat

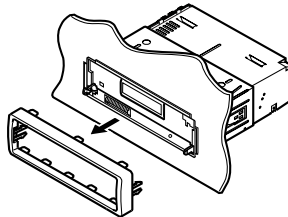

3

Handle
Griff
Poignée
Hendel

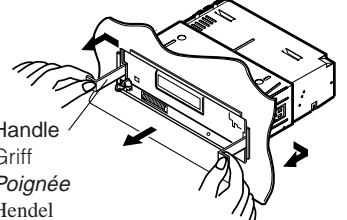

Parts list for installation and connection

The following parts are provided with this unit. After checking them, please set them correctly.

Teileliste für den Einbau und Anschluß

Die folgenden Teile werden zusammen mit diesem Gerät geliefert. Nach ihrer Überprüfung, die Teile richtig einsetzen.

Liste des pièces pour l'installation et raccordement

Les pièces suivantes sont fournies avec cet appareil. Après vérification, veuillez les placer correctement.

Lijst van onderdelen die u bij installatie en aansluiting nodig hebt

De volgende onderdelen worden bij het apparaat geleverd. Installeer ze op de juiste wijze, nadat u ze hebt gecontroleerd.

Hard case/Control panel
Etui/Schalttafel
Etui de transport/Panneau de commande
Behuizing/Bedieningspaneel

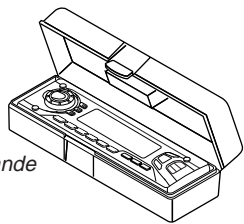

Sleeve
Halterung
Manchon
Huis

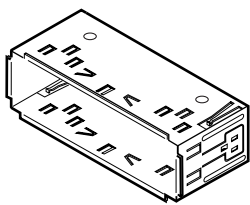

Trim plate
Frontrahmen
Plaque d'assemblage
Sierplaat

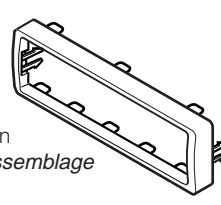

ONLY FOR KS-FX922R
NUR FÜR KS-FX922R
SEULEMENT POUR LE KS-FX922R
ALLEEN VOOR KS-FX922R

Remote controller
Fernbedienung
Télécommande
Afstandsbediening

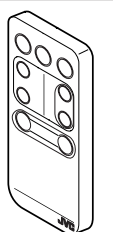

Battery
Batterie
Pile
Batterij
CR2025

Power cord
Stromkabel
Cordon d'alimentation
Stroomkabel

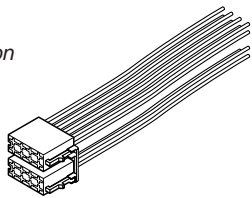

Handles
Griffe
Poignées
Hendels

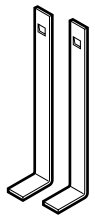

Washer (ø5)
Unterlegscheibe(ø5)
Rondelle (ø5)
Sluitring (ø5)



Lock nut (M5)
Sicherungsmutter (M5)
Ecrou d'arrêt (M5)
Contra-moer (M5)



Mounting bolt (M5 x 20 mm)
Befestigungsschraube (M5 x 20 mm)
Boulon de montage (M5 x 20 mm)
Bevestigingsbout (M5 x 20 mm)



Rubber cushion
Gummipuffer
Amortisseur en caoutchouc
Rubberdop



ELECTRICAL CONNECTIONS

ELEKTRISCHE ANSCHLÜSSE

RACCORDEMENTS ELECTRIQUES

ELEKTRISCHE VERBINDINGEN

To prevent short circuits, we recommend that you disconnect the battery's negative terminal and make all electrical connections before installing the unit. If you are not sure how to install this unit correctly, have it installed by a qualified technician.

Zur Vermeidung von Kurzschlüssen empfehlen wir, daß Sie den negativen Batterieanschluß abtrennen und alle elektrischen Anschlüsse herstellen, bevor das Gerät eingebaut wird. Sind Sie sich über den richtigen Einbau des Geräts nicht sicher, lassen Sie es von einem qualifizierten Techniker einbauen.

Pour éviter tout court-circuit, nous vous recommandons de débrancher la borne négative de la batterie et d'effectuer tous les raccordements électriques avant d'installer l'appareil. Si l'on n'est pas sûr de pouvoir installer correctement cet appareil, le faire installer par un technicien qualifié.

Om kortsluiting te voorkomen adviseren wij u om de minpool van de accu los te maken en alle elektrische verbindingen tot stand te brengen voordat u het apparaat in de auto installeert. Als u niet zeker weet hoe u dit apparaat moet installeren, kunt u dit beter door een daartoe gekwalificeerde technicus laten doen.

Note:

This unit is designed to operate on **12 V DC, NEGATIVE ground electrical systems**. If your vehicle does not have this system, a voltage inverter is required, which can be purchased at JVC IN-CAR ENTERTAINMENT dealers.

- Replace the fuse with one of the specified rating. If the fuse blows frequently, consult your JVC IN-CAR ENTERTAINMENT dealer.
- If noise is a problem... This unit incorporates a noise filter in the power circuit. However, with some vehicles, clicking or other unwanted noise may occur. If this happens, connect the unit's rear ground terminal (see connection diagram) to the car's chassis using shorter and thicker cords, such as copper braiding or gauge wire. If noise still persists, consult your JVC IN-CAR ENTERTAINMENT dealer.
- Maximum input of the speakers should be no more than 45 W at the rear and 45 W at the front, with an impedance of 4 Ω to 8 Ω.
- **Be sure to ground this unit to the car's chassis.**
- The heat sink becomes very hot after use. Be careful not to touch it when removing this unit.

Hinweis:

Dieses Gerät ist für einen Betrieb in **elektrischen Anlagen mit 12 V Gleichstrom und (-) Erdung** ausgelegt. Verfügt Ihr Fahrzeug nicht über diese Anlage, ist ein Spannungsinverter erforderlich, der bei JVC Autoradiohändler erworben werden kann.

- Die Sicherung mit einer der entsprechenden Nennleistung ersetzen. Brennt die Sicherung häufig durch, wenden Sie sich an ihren JVC Autoradiohändler.
- Sind Störgeräusche ein Problem... Dieses Gerät enthält ein Störfilter im Stromkreis. Bei manchen Fahrzeugen kann jedoch ein Klicken oder andere unerwünschte Störgeräusche auftreten. Sollte das der Fall sein, die **hintere Erdungsanschlußklemme** (siehe Schaltplan) des Geräts am Fahrwerk des Fahrzeugs anschließen, dabei kürzere und dickere Kabel wie beispielsweise Kupfergeflecht draht oder Stahldraht verwenden. Bleibt Störgeräusch bestehen, wenden Sie sich an Ihren JVC Autoradiohändler.
- Maximale Eingangsleistung der Lautsprecher sollte nicht mehr als 45 W hinten und 45 W vorne sein, mit einer Impedanz von **4 Ω bis 8 Ω**.
- **Sicherstellen, daß das Gerät am Fahrwerk geerdet wird.**
- Das Abstrahlblech wird nach dem Gebrauch sehr heiß. Beim Ausbau des Geräts darauf achten, das Abstrahlblech nicht zu berühren.

Remarque:

Cet appareil est conçu pour fonctionner sur des sources de courant continu de **12 V à masse NEGATIVE**. Si votre véhicule n'offre pas ce type d'alimentation, il vous faut un convertisseur de tension, que vous pouvez acheter chez un revendeur d'autoradios JVC.

- Remplacer le fusible par un de la valeur précisée. Si le fusible saute souvent, consulter votre revendeur d'autoradios JVC.
- Si le bruit est un problème... Cet appareil incorpore un filtre de bruit dans le circuit d'alimentation. Cependant, avec certains véhicules, quelques claquements ou autres bruits non désirés risquent de se produire. Si cela arrive, raccorder la borne arrière de masse de l'appareil au châssis de la voiture (voir le diagramme de raccordement) en utilisant des cordons les plus gros et les plus courts possibles telle qu'une barre de cuivre ou une tresse. Si le bruit persiste, consulter votre revendeur d'autoradios JVC.
- La puissance admissible des enceintes devrait n'être pas plus qu' c 45 W à l'arrière et à 45 W l'avant, avec une impédance de **4 Ω à 8 Ω**.
- **S'assurer de raccorder la mise à la masse de cet appareil au châssis de la voiture.**
- Le dissipateur de chaleur devient très chaud après usage. Faire attention de ne pas le toucher en retirant cet appareil.

Opmerking:

Dit apparaat mag worden gebruikt bij elektrische systemen die werken op **12 V gelijkstroom met negatieve aarding**. Als uw auto niet is uitgerust met een dergelijk systeem, is een spanningsomzetter vereist. Dit instrument kan worden aangeschaft bij JVC car audio dealers.

- Vervang de zekering door een exemplaar met het aangegeven vermogen. Als de zekering vaak doorslaat, moet u uw JVC car audio dealer raadplegen.
- Als u geluidsproblemen hebt... De krachtschakeling van dit apparaat heeft een ingebouwd geluidsfilter. In sommige voertuigen zijn tikgeluiden of andere ongewenste geluiden te horen. Als dit gebeurt, moet u de **massaklem aan de achterkant** (zie aansluitingsschema) aan het chassis van de auto vastmaken met behulp van een kortere en dikkere kabel, zoals kopermanteldraad of tellerkabel. Als het geluid niet verdwijnt, moet u contact opnemen met uw JVC car audio dealer.
- Het maximum ingangsvermogen van de speakers moet achterin niet meer dan 45 W zijn en voorin 45 W, met een impedantie van **4 Ω tot 8 Ω**.
- **Zorg ervoor dat dit apparaat door middel van een aardkabel is verbonden met het chassis van de auto.**
- De warmte-opnemer kan na gebruik erg heet worden. Raak de warmte-opnemer niet aan wanneer u dit apparaat van zijn plaats haalt.

Heat sink
Abstrahlblech
Dissipateur de chaleur
Warmte-opnemer

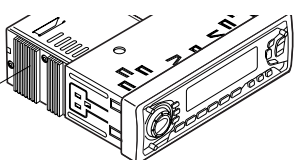

A Typical Connections / Typische Anschlüsse / Raccordements typiques / Normale verbindingen

Before connecting: Check the wiring in the vehicle carefully. Incorrect connection may cause serious damage to this unit.

1 Connect the colored leads of the power cord to the car battery, speakers and power aerial (if any) in the following sequence.

- ① Black: ground
- ② Yellow: to car battery (constant 12 V)
- ③ Red: to an accessory terminal
- ④ Blue with white stripe: to power aerial (200 mA max.)
- ⑤ Orange with white stripe (ONLY FOR KS-FX922R): to car light control switch
- ⑥ Brown: to cellular phone system (For details, refer to the instructions of the cellular phone.)
- ⑦ Others: to speakers

2 Connect the aerial cord.

3 Finally connect the wiring harness to the unit.

Note: If your vehicle does not have any accessory terminal, move the fuse from the fuse position 1 (initial position) to fuse position 2, and connect the red lead (A7) to the positive (+) battery terminal.

- The yellow lead (A4) is not used in this case.

Vor dem Anschließen: Die Verdrahtung im Fahrzeug sorgfältig überprüfen. Falsche Anschlüsse können ernsthafte Schäden am Gerät hervorrufen.

1 Die farbigen Leitungen des Spannungsversorgungskabels an der Autobatterie, den Lautsprechern und dem Motorantenne (sofern vorhanden) in folgender Reihenfolge anschließen.

- ① Schwarz: Erdung
- ② Gelb: an Autobatterie (konstant 12 V)
- ③ Rot: an Zubehörschlussklemme
- ④ Blau mit weißem Streifen: an Motorantenne (max. 200 mA)
- ⑤ Orange mit weißem Streifen (NUR FÜR KS-FX922R): zum Autolichtschalter
- ⑥ Braun: an Mobiltelefon (Weitere Informationen entnehmen Sie bitte der Bedienungsanleitung des Mobiltelefons.)
- ⑦ Andere: an Lautsprecher

2 Das Antennenkabel anschließen.

3 Die Kabelbäume am Gerät anschließen.

Hinweis: Verfügt Ihr Fahrzeug nicht über eine Zubehörschlussklemme, die Sicherung von der 1. Sicherungsposition (Erstposition) in die 2. Sicherungsposition versetzen, die rote Leitung (A7) an der (+) Batterieanschlussklemme anschließen.

- Die gelbe Leitung (A4) wird in diesem Fall nicht verwendet.

Avant de commencer la connexion: vérifiez attentivement le câblage du véhicule. Une connexion incorrecte peut endommager sérieusement l'appareil.

1 Connectez les fils de couleur du cordon d'alimentation à la batterie de la voiture, aux enceintes et à l'antenne automatique (s'il y en a une) dans l'ordre suivant.

- ① Noir: a la masse
- ② Jaune: a la batterie de la voiture (12 V constant)
- ③ Rouge: à la prise accessoire
- ④ Bleu avec bande blanche: à l'antenne automatique (200 mA max.)
- ⑤ Orange avec bande blanche (SEULEMENT POUR LE KS-FX922R): à l'interrupteur d'éclairage de la voiture
- ⑥ Marron: à un système de téléphone cellulaire (Pour les détails, se référer aux instructions du téléphone cellulaire.)
- ⑦ Autres: aux enceintes

2 Connectez le cordon d'antenne.

3 Finalement, connectez le faisceau de fils à l'appareil.

Remarque: Si votre véhicule ne possède pas de borne accessoire, déplacez le fusible de la position de fusible 1 (position originale) à la position de fusible 2 et connectez le fil rouge (A7) à la borne positive (+) de la batterie.

- Le fil jaune (A4) n'est pas utilisé dans ce cas.

Alvorens de verbindingen tot stand te brengen: moet u de bedrading in de auto zorgvuldig. Het apparaat kan door verkeerde verbindingen ernstige schade oplopen.

1 Sluit de gekleurde snoerdraden van de stroomkabel in de hierna genoemde volgorde aan op de accu van de auto, de luidsprekers en de antenne (indien aanwezig).

- ① Zwart: aarde
- ② Geel: naar de accu van de auto (constant 12 V)
- ③ Rood: naar de aansluitklem van de accessoire
- ④ Blauw met witte streep: naar de antenne (Max. 200 mA)
- ⑤ Oranje met witte streep (ALLEEN VOOR KS-FX922R): naar de schakelaar voor de autoverlichting
- ⑥ Bruin: Naar het mobiele-telefoonstelsel (Lees voor meer informatie de instructies die bij de mobiele telefoon worden geleverd.)
- ⑦ Andere: naar de speakers

2 Sluit de antenne aan.

3 Verbind de draadbundel daarna met het apparaat.

Opmerking: Als uw voertuig niet beschikt over een aansluitklem, moet u de zekering verplaatsen van stand 1 (beginstand) naar stand 2 en moet u de rode draad (A7) met de pluspool (+) van de accu verbinden.

- In dit geval wordt de gele draad (A4) niet gebruikt.

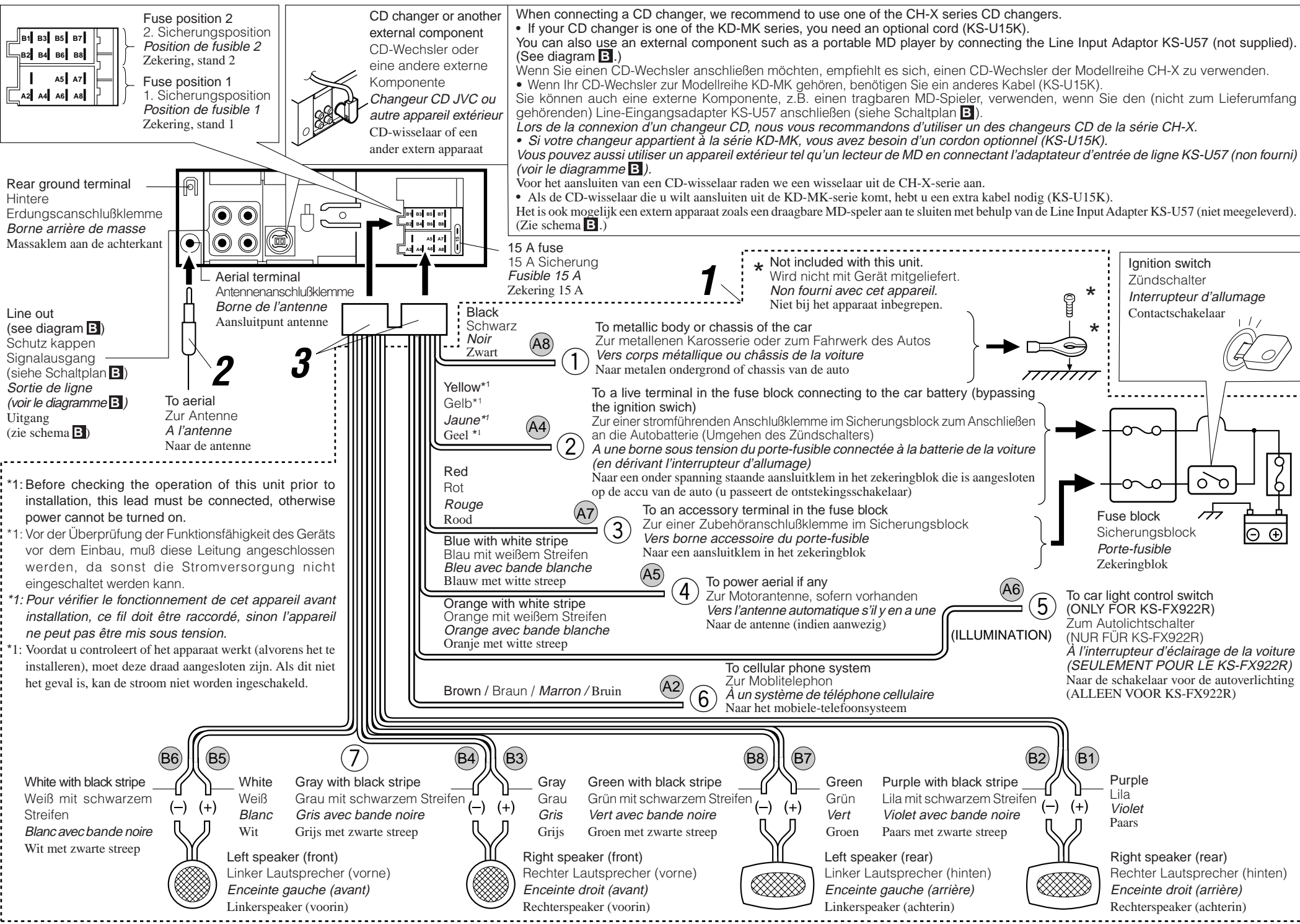

PRECAUTIONS on power supply and speaker connections:

- DO NOT connect the speaker leads of the power cord to the car battery; otherwise, the unit will be seriously damaged.
- Connect the black lead (ground), yellow lead (to car battery, constant 12 V), and red lead (to an accessory terminal) correctly.
- BEFORE connecting the speaker leads of the power cord to the speakers, check the speaker wiring in your car.
 - If the speaker wiring in your car is as illustrated in Fig. 1 and Fig. 2 below, DO NOT connect the unit using that original speaker wiring. If you do, the unit will be seriously damaged.
 - Redo the speaker wiring so that you can connect the unit to the speakers as illustrated in Fig. 3.
 - If the speaker wiring in your car is as illustrated in Fig. 3, you can connect the unit using the original speaker wiring in your car.
 - If you are not sure of the speaker wiring of your car, consult your car dealer.

VORSICHTSMASSREGELN beim Anschließen der Stromversorgung und Lautsprecher:

- Die Lautsprecherleitungen des Netzkabels NICHT an der Autobatterie anschließen, da sonst das Gerät schwer beschädigt wird.
- Die schwarze Leitung (Erdung), die gelbe Leitung (zur Autobatterie, konstant 12 V) und die rote Leitung (zur Zubehörschlussklemme) richtig anschließen.
- VOR dem Anschließen der Lautsprecherleitungen des Spannungsversorgungskabels an die Lautsprecher, die Lautsprecherverdrahtung in Ihrem Auto überprüfen.
 - Ist die Lautsprecherverdrahtung wie unten in "Fig. 1" und "Fig. 2" abgebildet, das Gerät NICHT mit der Originalverdrahtung der Lautsprecher anschließen, da sonst das Gerät schwer beschädigt wird.
 - Die Lautsprecherverdrahtung erneuern, so daß Sie das Gerät an den Lautsprechern wie in "Fig. 3" abgebildet anschließen können.
 - Ist die Lautsprecherverdrahtung in Ihrem Auto wie in "Fig. 3" abgebildet, können Sie das Gerät mit der Originalverdrahtung der Lautsprecher in Ihrem Auto anschließen.
 - Sind Sie sich über die Lautsprecherverdrahtung in Ihrem Auto nicht sicher, wenden Sie sich an Ihren Autohändler.

PRECAUTIONS sur l'alimentation et la connexion des enceintes:

- NE CONNECTEZ PAS les fils d'enceintes du cordon d'alimentation à la batterie; sinon, l'appareil serait sérieusement endommagé.
- Connectez correctement le fil noir (a la masse), le fil jaune (a la batterie de la voiture, 12 V constant) et le fil rouge (à la prise accessoire).
- AVANT de connecter les fils d'enceintes du cordon d'alimentation aux enceintes, vérifiez le câblage des enceintes de votre voiture.
 - Si le câblage des enceintes de votre voiture est comme montré sur la Fig. 1 ou Fig. 2 ci-dessous, NE CONNECTEZ PAS l'appareil en utilisant ce câblage original des enceintes. Si vous le faites, l'appareil sera sérieusement endommagé. Recommencez le câblage des enceintes de façon que vous puissiez connecter l'appareil aux enceintes comme montré sur la Fig. 3.
 - Si le câblage des enceintes de votre voiture est comme montré sur la Fig. 3, vous pouvez connecter l'appareil en utilisant ce câblage original d'enceintes pour votre voiture.
 - Si vous n'êtes pas sûrs du câblage d'enceintes de votre voiture, consultez le concessionnaire de votre voiture.

VOORZORGSMAATREGELEN bij het verbinden van de stroomkabel met de speakers:

- Verbind de speakerdraden van de stroomkabel NIET met de accu van de auto; als u dit wel doet, zal het apparaat ernstige schade oplopen.
- Sluit de zwarte draad (aarde), de gele draad (naar de accu van de auto, constant 12 V) en de rode draad (naar de aansluitklem van de accessoire) op de juiste wijze aan.
- VOORDAT u de speakerdraden van de stroomkabel met de speakers verbindt, moet u de bedrading van de speakers in uw auto controleren.
 - Als de bedrading van de speakers eruit ziet zoals hieronder staat afgebeeld in Fig. 1 en Fig. 2, mag het apparaat NIET worden aangesloten met behulp van deze oorspronkelijke speakerbedrading. Als u dat wel doet, zal het apparaat ernstige schade oplopen.
 - Pas de bedrading van de speakers aan, zodat u het apparaat met de speakers kunt verbinden, zoals staat afgebeeld in Fig. 3.
 - Als de bedrading van de speakers eruit ziet zoals staat afgebeeld in Fig. 3, kunt u het apparaat aansluiten met behulp van de oorspronkelijke speakerbedrading in uw auto.
 - Als u twijfels hebt over de speakerbedrading in uw auto, moet u contact opnemen met uw autodealer.

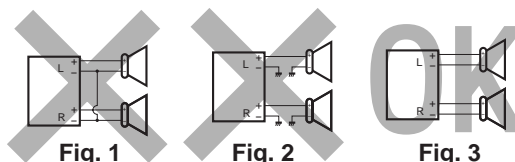

Connecting the leads / Anschließen der Leitungen / Raccordement des fils / Aansluiting van de gekleurde draden

Twist the core wires when connecting.
Die Kerndrähte beim Anschließen verdrehen.
Torsader les âmes des fils en les raccordant.
Draai de kerndraden om elkaar heen wanneer u ze wilt aansluiten.

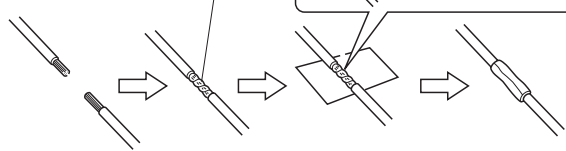

Solder the core wires to connect them securely.
Die Kerndrähte anlöten, um sie fest anzuschließen.
Souder les âmes des fils pour les raccorder entre eux de façon sûre.
Soldeer de kerndraden zodat ze stevig vast zitten.

CAUTION / VORSICHT / PRECAUTION / LET OPI!

- To prevent short-circuit, cover the terminals of the UNUSED leads with insulating tape.
- Zur Vermeidung eines Kurzschlusses die Anschlußklemmen der NICHT VERWENDETEN Leitungen mit Isolierklebeband umwickeln.
- Pour éviter les court-circuits, couvrir les bornes des fils qui ne sont PAS utilisés avec de la bande isolante.
- Om kortsluiting te voorkomen, moet u de aansluitklemmen van ONGEBRUIKTE gekleurde draden met isolatieband bedekken.

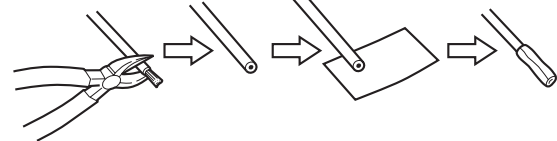

B Connections Adding Other Equipment / Anschlüsse zum Hinzufügen von anderer Ausrüstung / Raccordement pour ajouter d'autres appareils / Aansluitingen voor het toevoegen van andere apparatuur

Amplifier / Verstärker / Amplificateur / Versterker

You can connect an amplifier and other equipment to upgrade your car stereo system.

- Connect the remote lead (blue with white stripe) to the remote lead of the other equipment so that it can be controlled through this unit.
- For amplifier only:
 - Connect this unit's line-out terminals to the amplifier's line-in terminals.
 - Disconnect the speakers from this unit, connect them to the amplifier. Leave the speaker leads of this unit unused. (Cover the terminals of these unused leads with insulating tape, as illustrated above.)

Sie können einen Verstärker oder ein anderes Gerät anschließen, um Ihre Autostereoanlage zu erweitern.

- Schließen Sie das Fernbedienungskabel (blau mit weißem Streifen) an das Fernbedienungskabel des anderen Geräts an, so daß es über dieses Gerät gesteuert werden kann.
- Nur für den Verstärker:
 - Die Anschlußklemmen am Ausgang dieses Gerät an den Anschlußklemmen des Eingangs des Verstärkers anschließen.
 - Die Lautsprecher von diesem Gerät abtrennen und am Verstärker anschließen. Die Lautsprecherleitungen dieses Geräts unbenutzt lassen. (Die Anschlußklemmen dieser nicht verwendeten Leitungen mit Isolierklebeband umwickeln, siehe Abbildung oben.)

Vous pouvez connecter un amplificateur ou autre appareil pour améliorer votre système autoradio.

- Connectez le fil de commande à distance (bleu avec bande blanche) au fil de commande à distance de l'autre appareil de façon qu'il puisse être commandé via cet appareil.
- Pour l'amplificateur seulement:
 - Raccorder les bornes de sortie ligne de cet appareil aux bornes d'entrée ligne de l'amplificateur.
 - Déconnectez les enceintes de cet appareil et connectez-les à l'amplificateur. Laissez les fils d'enceintes de cet appareil inutilisés. (Recouvrir les extrémités de ces fils inutilisés avec de la bande isolante comme montré ci-dessus.)

Het is mogelijk om uw autostereosysteem uit te breiden met een versterker of andere apparatuur.

- Verbind de externe kabel (blauw met witte streep) met de externe kabel van het andere apparaat zodat deze op afstand vanaf deze apparaat kan worden bediend.
- Alleen voor een versterker:
 - Verbind de uitgang van het apparaat met de ingang van de versterker.
 - Koppel de speakers van dit apparaat los en verbind ze aan de versterker. Gebruik de speakerdraden van dit apparaat niet. (Plak de aansluitklemmen van deze speakerdraden met isolatieband af zoals hierboven is afgebeeld.)

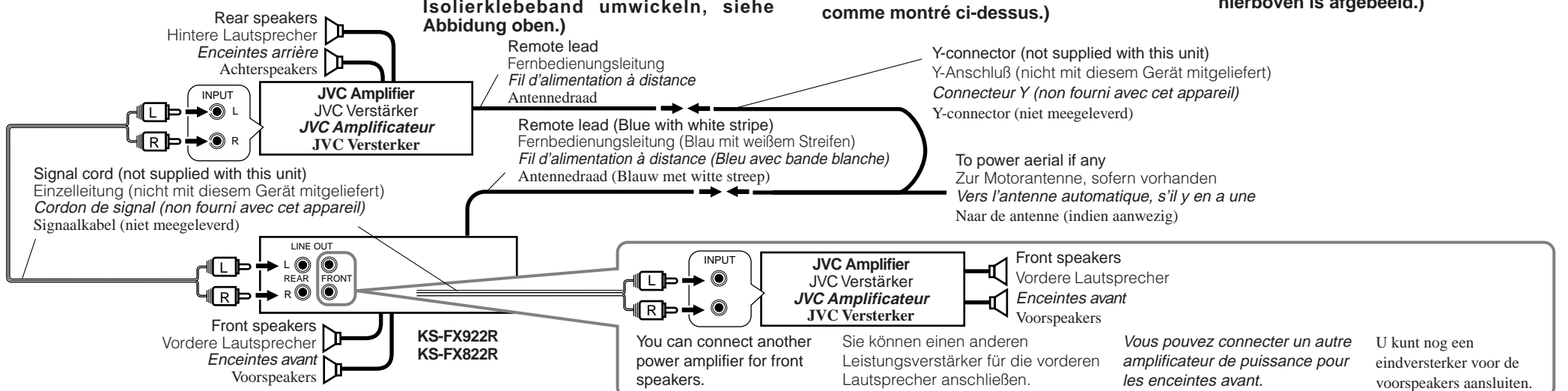

CD changer and DAB tuner / CD-Wechsler und DAB-Tuner / Changeur CD et tuner DAB / CD-wisselaar en DAB-tuner

You can connect a JVC CD changer and/or a JVC DAB (Digital Audio Broadcasting) tuner.

- For their connections, refer to the instructions supplied with them.

Sie können einen CD-Wechsler und/oder einen DAB-Tuner (Tuner für digitalen Rundfunk) von JVC anschließen.

- Weitere Informationen über den Anschluß können Sie der Bedienungsanleitung entnehmen, die dem jeweiligen Gerät beiliegt.

Vous pouvez connecter un changeur CD JVC et/ou un tuner DAB (Digital Audio Broadcast) JVC.

- Pour leurs connexions, référez-vous aux modes d'emploi qui les accompagnent.

Het is mogelijk een JVC CD-wisselaar en/of JVC DAB-tuner (Digital Audio Broadcasting) aan te sluiten.

- Zie de instructies van deze apparaten voor meer informatie over het tot stand brengen van deze aansluiting.

Connecting cord supplied with your DAB tuner
Verbindingskabel, dat zum Lieferumfang des DAB-Tuners gehört
Cordon de connexion fourni avec votre tuner DAB
Verbindingskabel die met de DAB-tuner wordt meegeleverd

Connecting cord supplied with your CD changer
Verbindingskabel, dat zum Lieferumfang des CD-Wechslers gehört
Cordon de connexion fourni avec votre changeur CD
Verbindingskabel die met de CD-wisselaar wordt meegeleverd

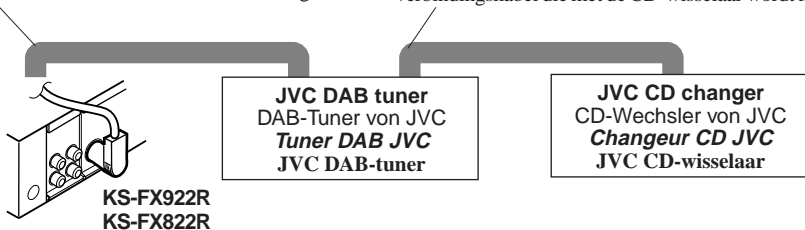

- You can connect both components in series as illustrated above.
- Es ist möglich, beide Komponenten in einer Serienschaltung entsprechend der obigen Darstellung anzuschließen.
- Vous pouvez connecter les deux appareils en série comme montré ci-dessus.
- Beide apparaten zijn volgens bovenstaande illustratie in serie aan te sluiten.

Connecting cord supplied with your DAB tuner or CD changer
Verbindingskabel, dat zum Lieferumfang des DAB-Tuners oder CD-Wechslers gehört
Cordon de connexion fourni avec votre tuner DAB ou changeur CD
Verbindingskabel die met de DAB-tuner of CD-wisselaar wordt meegeleverd

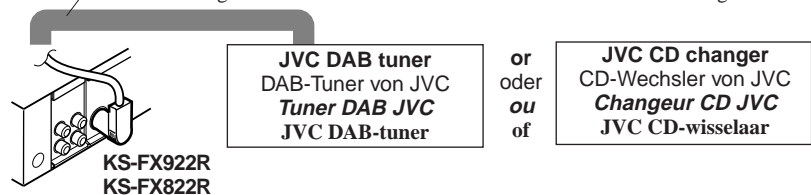

CAUTION / VORSICHT / PRECAUTION / LET OPI!

- Before connecting the CD changer and/or the DAB tuner, make sure that the unit is turned off.
- Bevor Sie den CD-Wechsler und/oder den DAB-Tuner anschließen, vergewissern Sie sich, daß das Gerät ausgeschaltet ist.
- Avant de connecter le changeur CD et/ou le tuner DAB, s'assurer que l'unité est éteinte.
- Zorg ervoor dat de apparat is uitgeschakeld alvorens u de en/of DAB-tuner CD-wisselaar aansluit.

External component / Externe Komponente / Appareil extérieur / Extern apparaat

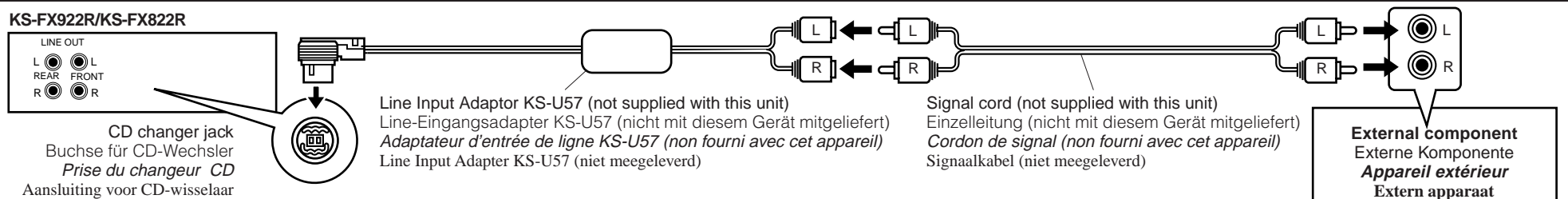

TROUBLESHOOTING

FEHLERSUCHE

EN CAS DE DIFFICULTES

PROBLEMEN OPLOSSEN

- The fuse blows.**
 - Are the red and black leads connected correctly?
- Power cannot be turned on.**
 - Is the yellow lead connected?
- No sound from the speakers.**
 - Is the speaker output lead short-circuited?
- Sound is distorted.**
 - Is the speaker output lead grounded?
 - Are the "-" terminals of L and R speakers grounded in common?
- Unit becomes hot.**
 - Is the speaker output lead grounded?
 - Are the "-" terminals of L and R speakers grounded in common?

- Die Sicherung brennt durch.**
 - Sind die roten und schwarzen Leitungen richtig angeschlossen?
- Stromversorgung kann nicht eingeschaltet werden.**
 - Ist die gelbe Leitung angeschlossen?
- Kein Ton aus den Lautsprechern.**
 - Ist die Lautsprecherausgangsleitung kurzgeschlossen?
- Ton verzerrt.**
 - Ist die Lautsprecherausgangsleitung geerdet?
 - Sind die (-) Anschlußklemmen der linken und rechten Lautsprecher zusammen geerdet?
- Gerät wird heiß.**
 - Ist die Lautsprecherausgangsleitung geerdet?
 - Sind die (-) Anschlußklemmen der linken und rechten Lautsprecher zusammen geerdet?

- Le fusible saute.**
 - Les fils rouge et noir sont-ils raccordés correctement?
- L'appareil ne peut pas être mise sous tension.**
 - Le fil jaune est-elle raccordée?
- Pas de son des enceintes.**
 - Le fil de sortie d'enceinte est-il court-circuité?
- Le son est déformé.**
 - Le fil de sortie d'enceinte est-il à la masse?
 - Les bornes "-" des enceintes gauche et droit sont-elles mises ensemble à la masse?
- L'appareil devient chaud.**
 - Le fil de sortie d'enceinte est-il à la masse?
 - Les bornes "-" des enceintes gauche et droit sont-elles mises ensemble à la masse?

- De zekering slaat door.**
 - Zijn de rode en de zwarte draden op de juiste manier aangesloten?
- De stroom kan niet worden ingeschakeld.**
 - Is de gele draad aangesloten?
- Er komt geen geluid uit de speakers.**
 - Is de uitgaande speakerdraad kortgesloten?
- Het geluid wordt vervormd.**
 - Is de uitgaande speakerdraad geaard?
 - Zijn de minpolen van de linker- en de rechterspeakers gemeenschappelijk geaard?
- Het apparaat raakt verhit.**
 - Is de uitgaande speakerdraad geaard?
 - Zijn de minpolen van de linker- en de rechterspeakers gemeenschappelijk geaard?