

HT-E5500W

5.1 CH Blu-ray™
Home Entertainment System
user manual

imagine the possibilities

Thank you for purchasing this Samsung product.
To receive more complete service,
please register your product at
www.samsung.com/register



Safety Information

Warning

TO REDUCE THE RISK OF ELECTRIC SHOCK, DO NOT REMOVE THE COVER (OR BACK). NO USER-SERVICEABLE PARTS ARE INSIDE. REFER SERVICING TO QUALIFIED SERVICE PERSONNEL.

| | | |
|--|--|---|
|  | <div style="border: 1px solid black; padding: 5px;"> <p>CAUTION</p> <p>RISK OF ELECTRIC SHOCK DO NOT OPEN</p> </div> |  |
| <p>The lightning flash and Arrowhead within the triangle is a warning sign alerting you of dangerous voltage inside the product.</p> | <p>CAUTION: TO REDUCE THE RISK OF ELECTRIC SHOCK, DO NOT REMOVE COVER (OR BACK) NO USER SERVICEABLE PARTS INSIDE. REFER SERVICING TO QUALIFIED SERVICE PERSONNEL.</p> | <p>The explanation point within the triangle is a warning sign alerting you of important instructions accompanying the product.</p> |

WARNING

- To reduce the risk of fire or electric shock, do not expose this appliance to rain or moisture.

FCC NOTE (for U.S.A)

This equipment has been tested and found to comply with the limits for a Class B digital device, pursuant to Part 15 of the FCC rules. These limits are designed to provide reasonable protection against harmful interference in a residential installation. This equipment generates, uses and can radiate radio frequency energy and, if not installed and used in accordance with the instructions, may cause harmful interference to radio or television reception, which can be determined by turning the equipment off and on.

The user is encouraged to try to correct the interference by one or more of the following measures.

- Reorient or relocate the receiving antenna.
- Increase the separation between the equipment and receiver.
- Connect this equipment into an outlet on a circuit different from that to which the receiver is connected.
- Consult the dealer or an experienced radio/TV technician for help.
- This class B digital product meets all requirements of the Canadian Interference - Causing Equipment Regulations.

CLASS 1 LASER PRODUCT

This Compact Disc player is classified as a CLASS 1 LASER product. Use of controls, adjustments or performance of procedures other than those specified herein may result in hazardous radiation exposure.

Complies with 21CFR 1040.10 except for deviations pursuant to Laser Notice No. 50, dated June 24, 2007.

DANGER :

- VISIBLE AND INVISIBLE LASER RADIATION WHEN OPEN. AVOID DIRECT EXPOSURE TO BEAM. (FDA 21 CFR)

CAUTION :

- CLASS 3B VISIBLE AND INVISIBLE LASER RADIATION WHEN OPEN. AVOID EXPOSURE TO THE BEAM (IEC 60825-1)
- THIS PRODUCT UTILIZES A LASER. USE OF CONTROLS OR ADJUSTMENTS OTHER THAN THOSE SPECIFIED HEREIN MAY RESULT IN HAZARDOUS RADIATION EXPOSURE. DO NOT OPEN COVER AND DO NOT REPAIR YOURSELF. REFER SERVICING TO QUALIFIED PERSONNEL.

| | |
|----------|---------------|
| CLASS 1 | LASER PRODUCT |
| KLASSE 1 | LASER PRODUKT |
| LUOKAN 1 | LASER LAITE |
| KLASS 1 | LASER APPARAT |
| PRODUCTO | LÁSER CLASE 1 |

Precautions

Important Safety Instructions

Read these operating instructions carefully before using the unit. Follow all the safety instructions listed below.



Keep these operating instructions handy for future reference.

- 1 . Read these instructions.
- 2 . Keep these instructions.
- 3 . Heed all warnings.
- 4 . Follow all instructions.
- 5 . Do not use this apparatus near water.
- 6 . Clean only with a dry cloth.
- 7 . Do not block any ventilation openings. Install in accordance with the manufacturer's instructions.
- 8 . Do not install near any heat sources such as radiators, heat registers, stoves, or other apparatus (including AV receivers) that produce heat.
- 9 . Do not defeat the safety purpose of the polarized or grounding-type plug. A polarized plug has two blades with one wider than the other. A grounding type plug has two blades and a third grounding prong. The wide blade or the third prong are provided for your safety. If the provided plug does not fit into your outlet, consult an electrician for replacement of the obsolete outlet.
- 10 . Protect the power cord from being walked on or pinched particularly at plugs, convenience receptacles, and the point where it exits the apparatus.
- 11 . Only use attachments/accessories specified by the manufacturer.
- 12 . Use only with the cart, stand, tripod, bracket, or table specified by the manufacturer, or sold with the apparatus. When a cart is used, use caution when moving the cart/apparatus combination to avoid injury from tip-over.



- 13 . Unplug this apparatus during lightning storms or when unused for long periods of time.
- 14 . Refer all servicing to qualified service personnel. Servicing is required when the apparatus has been damaged in any way, such as when the power-supply cord or plug is damaged, liquid has been spilled or objects have fallen into the apparatus, the apparatus has been exposed to rain or moisture, does not operate normally, or has been dropped.

Disc Storage & Management

- Holding Discs
 - Fingerprints or scratches on a disc may reduce sound and picture quality or cause skipping. 
 - Avoid touching the surface of a disc where data has been recorded.
 - Hold the disc by the edges so that fingerprints will not get on the surface.
 - Do not stick paper or tape on the disc.
- Cleaning Discs
 - If you get fingerprints or dirt on a disc, clean it with a mild detergent diluted in water and wipe with a soft cloth. 
 - When cleaning, wipe gently from the inside to the outside of the disc.
- Disc Storage
 - Do not keep in direct sunlight.
 - Keep in a cool ventilated area.
 - Keep in a clean protection jacket and store vertically.

Handling Cautions

- Do not expose this apparatus to dripping or splashing. Do not put objects filled with liquids, such as vases, on the apparatus.
- To turn this apparatus off completely, you must pull the power plug out of the wall socket. Consequently, the power plug must be easily and readily accessible at all times.
- Do not touch the power plug with a wet hand. It can cause an electric shock.

Safety Information

- Do not plug multiple electric devices into the same wall socket. Overloading a socket can cause it to overheat, resulting in a fire.
- Maintenance of the Cabinet
 - Before connecting other components to this product, be sure to turn them off.
 - If you move your product suddenly from a cold place to a warm place, condensation may occur on the operating parts and lens and cause abnormal disc playback. If this occurs, unplug the product, wait for two hours, and then connect the plug to the power outlet. Then, insert the disc, and try to play back again.
- If the product makes an abnormal noise or produces a burning smell or smoke, turn off the power switch immediately and disconnect the power plug from the wall outlet. Then, contact the nearest customer service center for technical assistance. Do not use the product. Using the product as it is may cause a fire or an electric shock.
- To turn this apparatus off completely, you must pull the power plug out of the wall socket. Consequently, the power plug must be easily and readily accessible at all times.
- Do not use the 3D Active Glasses for other purposes (such as general eyeglasses, sunglasses, protective goggles, etc.)
- Do not use the 3D function or 3D Active Glasses while walking or moving around. Using the 3D function or 3D Active Glasses while moving around may cause you to bump into objects, trip, and/or fall, and cause serious injury.
- If you want to enjoy 3D content, connect a 3D device (3D compliant AV receiver or TV) to the product's HDMI OUT port using a high-speed HDMI cable. Put on 3D glasses before playing the 3D content.
- The product outputs 3D signals only through HDMI cable connected to the HDMI OUT port.
- As the video resolution in 3D play mode is fixed according to the resolution of the original 3D video, you can not change the resolution to your preference.
- Some functions such as BD Wise, screen size adjustment, and resolution adjustment may not operate properly in 3D play mode.
- You must use a high-speed HDMI cable for proper output of the 3D signal.
- Stay at least three times the width of the screen from the TV when watching 3D images. For example, if you have a 46 inch screen, stay 138 inches (11.5 feet) from the screen.
 - Place the 3D video screen at eye level for the best 3D picture.
- When the product is connected to some 3D devices, the 3D effect may not function properly.
- This product does not convert 2D content into 3D.
- "Blu-ray 3D" and "Blu-ray 3D" logo are trademarks of the Blu-ray Disc Association.

Using the 3D Function

IMPORTANT HEALTH AND SAFETY INFORMATION FOR 3D PICTURES.

Read and understand the following safety information before using the 3D function.

- Some viewers may experience discomfort while viewing 3D TV such as dizziness, nausea, and headaches.
If you experience any such symptom, stop viewing 3D TV, remove the 3D Active Glasses, and rest.
- Watching 3D images for an extended period of time may cause eye strain. If you feel eye strain, stop viewing 3D TV, remove your 3D Active Glasses, and rest.
- A responsible adult should frequently check on children who are using the 3D function. If there are any reports of tired eyes, headaches, dizziness, or nausea, have the child stop viewing 3D TV and rest.

Copyright

© 2012 Samsung Electronics Co.,Ltd.

All rights reserved; No part or whole of this user's manual may be reproduced or copied without the prior written permission of Samsung Electronics Co.,Ltd.

License



- Dolby and the double-D symbol are registered trademarks of Dolby Laboratories.



- Manufactured under license under U.S. Patent Nos: 5,956,674; 5,974,380; 6,226,616; 6,487,535; 7,392,195; 7,272,567; 7,333,929; 7,212,872 & other U.S. and worldwide patents issued & pending. DTS-HD, the Symbol, & DTS-HD and the Symbol together are registered trademarks & DTS-HD Master Audio | Essential is a trademark of DTS, Inc. Product includes software. © DTS, Inc. All Rights Reserved.



- The terms HDMI and HDMI High-Definition Multimedia Interface, and the HDMI Logo are trademarks or registered trademarks of HDMI Licensing LLC in the United States and other countries.



- Oracle and Java are registered trademarks of Oracle and/or its affiliates. Other names may be trademarks of their respective owners.
- This item incorporates copy protection technology that is protected by U.S. patents and other intellectual property rights of Rovi Corporation. Reverse engineering and disassembly are prohibited.
- Blu-ray Disc™, Blu-ray™, and the logos are trademarks of Blu-ray Disc Association.



- iPad, iPhone, iPod, iPod classic, iPod nano, iPod shuffle, and iPod touch are trademarks of Apple Inc., registered in the U.S. and other countries.

- This product uses Cinavia technology to limit the use of unauthorized copies of some commercially-produced film and videos and their soundtracks. When a prohibited use of an unauthorized copy is detected, a message will be displayed and playback or copying will be interrupted.

More information about Cinavia technology is provided at the Cinavia Online Consumer Information Center at <http://www.cinavia.com>. To request additional information about Cinavia by mail, send a postcard with your mailing address to: Cinavia Consumer Information Center, P.O. Box 86851, San Diego, CA, 92138, USA.”

This product incorporates proprietary technology under license from Verance Corporation and is protected by U.S. Patent 7,369,677 and other U.S. and worldwide patents issued and pending as well as copyright and trade secret protection for certain aspects of such technology. Cinavia is a trademark of Verance Corporation.

Copyright 2004-2010 Verance Corporation. All rights reserved by Verance. Reverse engineering or disassembly is prohibited.

- Open Source License Notice
 - In the case of using open source software, Open Source Licenses are available on the product menu.

Contents

SAFETY INFORMATION

- 2 Warning
- 3 Precautions
- 3 Disc Storage & Management
- 3 Handling Cautions
- 4 Using the 3D Function
- 4 Copyright
- 5 License

GETTING STARTED

- 7 Disk and Format Compatibility
- 8 Logos of Discs the product can play
- 11 Accessories
- 12 Front Panel
- 12 Rear Panel
- 13 Remote Control

CONNECTIONS

- 15 Attaching the Toroidal Ferrite Core to the Power Cord of the Main Unit
- 15 Connecting the Speakers
 - 16 Speaker Components
 - 16 Connecting The Speakers
- 18 Connecting the FM Antenna
- 18 Connecting to an iPod/iPhone
 - 18 Using a USB Cable
 - 18 Using a Dock
- 19 Connecting to a TV
 - 19 **Method 1** Connecting to a TV with an HDMI Cable - Best Quality (Recommended)
 - 19 **Method 2** Connecting to a TV with a Video Cable - Good Quality
- 20 Connecting to External Devices
 - 20 **Method 1** HDMI IN : Connecting to an External Component with an HDMI Cable
 - 20 **Method 2** OPTICAL : Connecting an External Digital Audio Component
 - 20 **Method 3** AUX IN : Connecting an External Analog Component
- 21 Connecting to a Network Router
 - 21 Wired Network
 - 21 Wireless Network

SETTINGS

- 22 The Initial Settings Procedure
- 24 The Home Screen
- 24 Accessing the Settings Screen
- 25 Settings Menu Functions
- 30 Networks and the Internet
- 34 Upgrading Software

MEDIA PLAY

- 36 The AllShare Play Screen
- 37 Playing Files on a USB Storage Device or iPod/iPhone
- 37 iPod/iPhone Models You Can Use with This Product
- 38 The Function Screen
- 38 Playing Commercial Video Discs
- 38 Playing Commercial Audio Discs
- 39 Playing a Disc with User Recorded Content
- 39 Using the AllShare Network Function
- 41 Controlling Video Playback
- 43 Controlling Music Playback
- 44 Playing Photo Contents
- 45 Using the Tools Menu when a File is Highlighted
- 47 Listening to Radio
- 47 Using the Special Effects Remote Control Buttons

NETWORK SERVICES

- 49 Using Smart Hub
- 51 BD-LIVE™
- 51 Using Disc to Digital

APPENDIX

- 52 Additional Information
- 58 Troubleshooting
- 61 Specifications

Disk and Format Compatibility

Disc types and contents your product can play

| Media | Disc Type | Details |
|-------|---|---|
| VIDEO | Blu-ray Disc 3D Blu-ray Disc | BD-ROM or BD-RE/-R disc recorded in the BD-RE format. |
| | DVD-VIDEO, DVD-RW, DVD-R, DVD+RW, DVD+R | DVD-VIDEO, recorded DVD+RW/DVD-RW(V)/DVD-R/+R discs that have been recorded and finalized, or a USB storage media containing MKV, MP4 contents. |
| MUSIC | CD-RW/-R, DVD-RW/-R, BD-RE/-R | Music recorded on CD-RW/-R, DVD-RW/-R, BD-RE/-R discs or a USB storage media containing MP3 or WMA contents. |
| PHOTO | CD-RW/-R, DVD-RW/-R, BD-RE/-R | Photos recorded on CD-RW/-R, DVD-RW/-R, BD-RE/-R discs or a USB storage media containing JPEG contents. |

| NOTE |

- ▶ The product may not play certain CD-RW/-R and DVD-R because of the disc type or recording conditions.
- ▶ If a DVD-RW/-R disc has not been recorded properly in DVD video format, it will not be playable.
- ▶ Your product will not play content that has been recorded on a DVD-R at a bitrate that exceeds 10 Mbps.
- ▶ Your product will not play content that has been recorded on a BD-R or USB device at a bitrate that exceeds 30 Mbps.
- ▶ Playback may not work for some types of discs, or when you use specific operations, such as angle change and aspect ratio adjustment. Information about the discs is written in detail on the disc box. Please refer to this if necessary.
- ▶ When you play a BD-J title, loading may take longer than a normal title or some functions may perform slowly.

Disc types your product cannot play

- HD DVD
- DVD-ROM/PD/MV-Disc, etc
- DVD-RAM
- Super Audio CD (except CD layer)
- DVD-RW(VR mode)
- CVD/CD-ROM/CDV/CD-G/CD-I/LD (CD-Gs play audio only, not graphics.)
- 3.9 GB DVD-R Disc for Authoring.

| NOTE |





- ▶ This product may not respond to all operating commands because some Blu-ray Disc, DVD, and CD discs allow specific or limited operation and provide only certain features during playback. Please note that this is not a defect in the product.
- ▶ Samsung cannot guarantee that this product will play every disc bearing the Blu-ray Disc, DVD or CD logo because disc formats evolve, and problems and errors may occur during the creation of Blu-ray Disc, DVD, and CD software and/or the manufacture of discs.
- ▶ Please contact the SAMSUNG Customer Care Center at 1-800-726-7864 if you have questions or encounter difficulty when playing Blu-ray Disc, DVD, or CD discs in this product. Also, refer to rest of this user manual for additional information on playback restrictions.
- ▶ Some commercial discs and DVD discs purchased outside your region may not play on this product.

Getting Started

Region Code

Both products and discs are coded by region. These regional codes must match for a disc to play. If the codes do not match, the disc will not play.







The Region Number for this product is displayed on the rear panel of the product.

| Disc Type | Region Code | Area |
|--------------|---|---|
| Blu-ray Disc |  | North America, Central America, South America, Korea, Japan, Taiwan, Hong Kong and South East Asia. |
| |  | Europe, Greenland, French territories, Middle East, Africa, Australia and New Zealand. |
| |  | India, China, Russia, Central and South Asia. |
| DVD-VIDEO |  | The U.S., U.S. territories and Canada |
| |  | Europe, Japan, the Middle East, Egypt, South Africa, Greenland |
| |  | Taiwan, Korea, the Philippines, Indonesia, Hong Kong |
| |  | Mexico, South America, Central America, Australia, New Zealand, Pacific Islands, Caribbean |
| |  | Russia, Eastern Europe, India, most of Africa, North Korea, Mongolia |
| |  | China |

| NOTE |

- ▶ If the Region number of a Blu-ray Disc/DVDs does not correspond to the Region number of this product, the product cannot play the disc.

Logos of Discs the product can play

| | |
|---|--|
|  |  |
| Blu-ray Disc | 3D Blu-ray Disc |
|  |  |
| BD-LIVE | Dolby |
|  |  |
| DTS | NTSC broadcast system in U.S.A, Canada, Korea, Japan |
|  | |
| Java | |

Supported Formats

Music File Support

| File Extension | Container | Audio Codec | Support Range |
|----------------|-----------|-------------|---|
| *.mp3 | MP3 | MP3 | - |
| *.wma | WMA | WMA | Compliant with WMA version 10 * Sampling rates (in kHz) - 8, 11, 16, 22, 32, 44.1, 48 * Bitrates - All bitrates in the range 5kbps to 384kbps |

Video File Support

| File Extension | Container | Video Codec | Resolution | Frame rate (fps) | Bitrate (Mbps) | Audio Codec |
|-----------------------|------------|-----------------------|------------|------------------|----------------|--------------------------------|
| *.avi | AVI | H.264 BP/MP/HP | 1920x1080 | 6 ~ 30 | 25 | MP3 AC3 LPCM DTS Core |
| | | MPEG4 SP/ASP | 1920x1080 | 6 ~ 30 | 8 | |
| *.mkv | MKV | H.264 BP/MP/HP | 1920x1080 | 6 ~ 30 | 25 | MP3 AC3 LPCM DTS Core |
| | | MPEG4 SP/ASP | 1920x1080 | 6 ~ 30 | 8 | |
| *.asf | ASF | H.264 BP/MP/HP | 1920x1080 | 6 ~ 30 | 25 | MP3 AC3 LPCM WMA |
| | | MPEG4 SP/ASP | 1920x1080 | 6 ~ 30 | 8 | |
| *.wmv | WMV (wmv9) | Window Media Video v9 | 1920x1080 | 6 ~ 30 | 25 | WMA |
| *.mp4 | MP4 | H.264 BP/MP/HP | 1920x1080 | 6 ~ 30 | 25 | MP3 AAC |
| | | MPEG4 SP/ASP | 1920x1080 | 6 ~ 30 | 8 | |
| *.3gp | 3GPP | H.264 BP/MP/HP | 1920x1080 | 6 ~ 30 | 25 | AAC |
| | | MPEG4 SP/ASP | 1920x1080 | 6 ~ 30 | 8 | |
| *.vro *.vob | VRO VOB | MPEG2 | 1920x1080 | 24/25/30 | 25 | AC3 MPEG LPCM |
| | | MPEG1 | 1920x1080 | 24/25/30 | 25 | |
| *.mpg *.mpeg | PS | MPEG1 | 1920x1080 | 24/25/30 | 25 | AC3 MPEG LPCM AAC |
| | | MPEG2 | 1920x1080 | 24/25/30 | 25 | |
| | | H.264 | 1920x1080 | 6 ~ 30 | 25 | |
| *.ts *.tp *.trp | TS | MPEG2 | 1920x1080 | 24/25/30 | 25 | AC3 AAC MP3 DD+ |
| | | H.264 | 1920x1080 | 6 ~ 30 | 25 | |
| | | VC1 | 1920x1080 | 6 ~ 30 | 25 | |

■ Limitations

- Even when a file is encoded by a supported codec listed above, the file might not be played if its content has a problem.
- Normal playback is not guaranteed if the file's container information is wrong or the file itself is corrupted.
- Files having higher bit or frame rates than standard may stutter when played back.

Getting Started

- The Seek (skip) function is not available if the file's index table is damaged.
- When you playback a file remotely through a network connection, video playback may stutter depending on the network speed.
- **Video decoder**
 - Supports up to H.264 Level 4.1
 - Does not support H.264 FMO/ASO/RS, VC1 SP/MP/AP L4 and AVCHD
 - MPEG4 SP, ASP :
 - Below 1280 x 720 : 60 frames max
 - Above 1280 x 720 : 30 frames max
 - Does not support GMC 2 or higher
- **Audio decoder**
 - Supports WMA 7, 8, 9 and STD
 - Does not support WMA 9 PRO multi-channel files if the number of channels is more than 2 or the files require lossless audio decoding.
 - Does not support WMA sampling rate of 22050Hz mono

Notes on the USB connection

- Your product supports USB storage media, MP3 players, digital cameras, and USB card readers.
- The product does not support folder or file names longer than 128 characters.
- Some USB/digital camera devices may not be compatible with the product.
- Your product supports the FAT 16, FAT 32, and NTFS files systems.
- Connect USB devices directly to the product's USB port. Connecting through a USB cable may cause compatibility problems.
- Inserting more than one memory device into a multi-card reader may cause the reader to operate improperly.
- The product does not support the PTP protocol.
- Do not disconnect a USB device during a "loading" process.
- The bigger the image resolution, the longer the image takes to display.

- This product cannot play MP3 files with DRM (Digital Rights Management) downloaded from commercial sites.
- Your product only supports video that is under 30fps (frame rate).
- Your product only supports USB Mass Storage Class (MSC) devices such as thumb drives and USB HDD. (HUB is not supported.)
- Certain USB HDD Devices, multi-card readers and thumb drives may not be compatible with this product.
- If some USB devices require excessive power, they may be limited by the circuit safety device.
- If playback from a USB HDD is unstable, provide additional power by plugging the HDD into a wall socket. If the problem continues, contact the USB HDD manufacturer.
- You must remove the USB storage device safely (by performing the "**Safely Remove USB**" function) to prevent possible damage to the USB memory.
Press the **HOME** button to move to the home menu, press the **YELLOW (C)** button, and then press the  button.
- SAMSUNG is not responsible for any data file damage or data loss.

AVCHD (Advanced Video Codec High Definition)







- This product can play back AVCHD format discs. These discs are normally recorded and used in camcorders.
- The AVCHD format is a high definition digital video camera format.
- The MPEG-4 AVC/H.264 format compresses images with greater efficiency than the conventional image compressing format.
- Some AVCHD discs use the "x.v.Color" format. This product can play back AVCHD discs that use "x.v.Color" format.
- "x.v.Color" is a trademark of Sony Corporation.
- "AVCHD" and the AVCHD logo are trademarks of Matsushita Electronic Industrial Co., Ltd. and Sony Corporation.

| NOTE |

- ▶ Some AVCHD format discs may not play, depending on the recording conditions.
- ▶ AVCHD format discs need to be finalized.
- ▶ "x.v.Color" offers a wider color range than normal DVD camcorder discs.
- ▶ Some MKV and MP4 format discs may not play, depending on their video resolution and frame rate.

Accessories

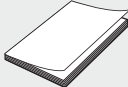
Check for the supplied accessories below.

| | | | |
|---|---|---|--|
|  |  |  |  |
| Video Cable (AH39-40001T) | FM Antenna (AH42-00021A) | iPod Dock (AH96-00051C) | |
|  |  (For Power cord) | | |
| User Manual (AH68-02434A) | Toroidal Ferrite Core (3301-000144) | | |
| | | | Remote Control (AH59-02402A)/ Batteries (AAA size) (4301-000116) |



- Figures and illustrations in this User Manual are provided for reference only and may differ from actual product appearance.

Getting Started

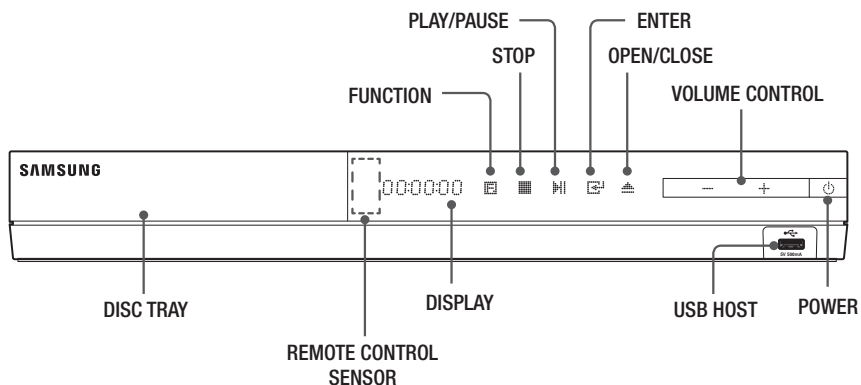
Front Panel



| NOTE |

- ▶ To upgrade the product's software through the USB Host jack, you must use a USB memory stick.
- ▶ When the product displays the Blu-ray Disc menu, you cannot start the movie by pressing the  button on the product or the remote. To play the movie, you must select Play Movie or Start in the disc menu, and then press the  button.

Rear Panel

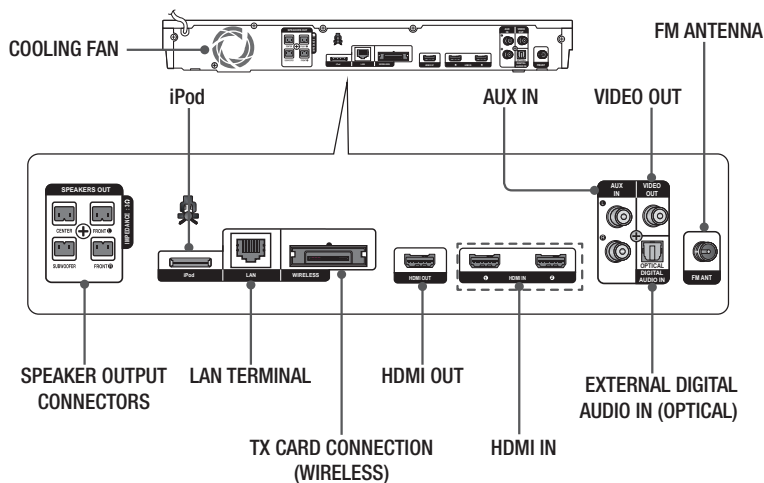

| NOTE |

- ▶ Ensure a minimum of 4 inches of clear space on all sides of the home theater to ensure adequate ventilation. Do not obstruct the cooling fan or ventilation holes.

Remote Control

Tour of the Remote Control

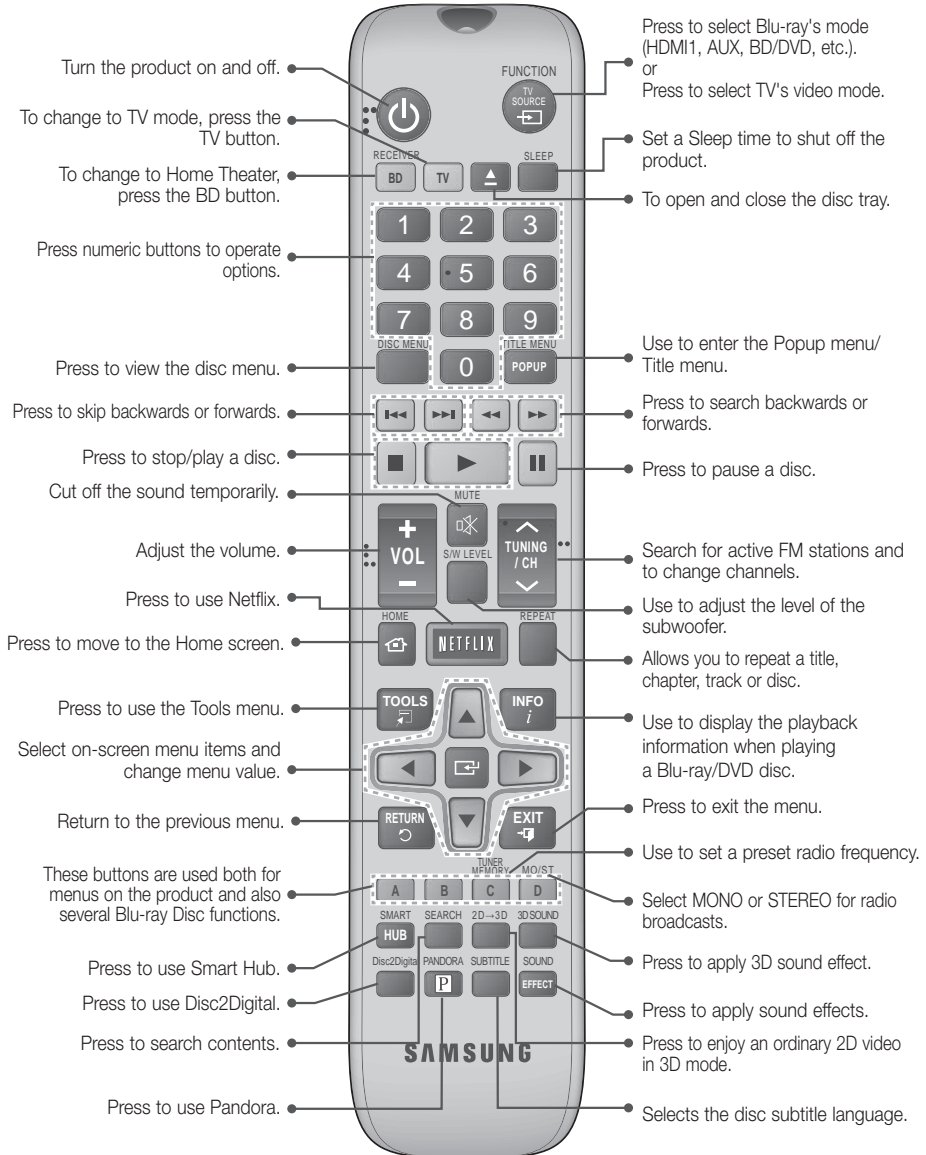

Getting Started

Installing batteries in the Remote Control

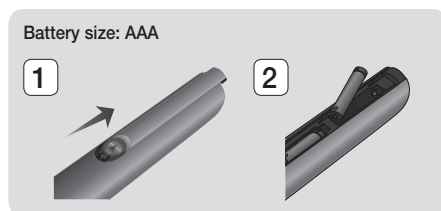

NOTE

- ▶ Make sure to match the “+” and “-” ends of the batteries with the diagram inside the compartment.
- ▶ Assuming typical TV usage, the batteries last for about one year.
- ▶ The remote control can be used up to approximately 23 feet (7 meters) from the product in a straight line.

Setting the Remote Control

You can control certain functions of your TV with this remote control.

When operating a TV with the remote control

1. Press the **TV** button to set the remote control to TV mode.
2. Turn on your TV.
3. While holding down the **POWER** button, enter the code corresponding to your brand of TV.
 - If there is more than one code listed for your TV in the table, enter one at a time to determine which code works.
 - **Example : For a Samsung TV**
While holding down the **POWER** button, use the number buttons to enter 00. If that does not work, try 15, then 16, etc.
4. If the TV turns off, the setting is complete.
 - You can use the TV **POWER**, **VOLUME**, **CHANNEL**, and **Numeric** buttons (0~9).

NOTE

- ▶ The remote control may not work on some brands of TV's. Also, some operations may not be possible, depending on your brand of TV.
- ▶ The remote control will work with Samsung TVs by default.

14 English

TV Control Codes

| Brand | Code | Brand | Code |
|-------------------------|--|--------------------------|--|
| Admiral (M.Wards) | 56, 57, 58 | Mitsubishi/MGA | 18, 40, 59, 60, 75 |
| A Mark | 01, 15 | MTC | 18 |
| Anam | 01, 02, 03, 04, 05, 06, 07, 08, 09, 10, 11, 12, 13, 14 | NEC | 18, 19, 20, 40, 59, 60 |
| AOC | 01, 18, 40, 48 | Nikei | 03 |
| Bell & Howell (M.Wards) | 57, 58, 81 | Onking | 03 |
| Brocsonic | 59, 60 | Onwa | 03 |
| Candle | 18 | Panasonic | 06, 07, 08, 09, 54, 66, 67, 73, 74 |
| Cetronic | 03 | Penney | 18 |
| Citizen | 03, 18, 25 | Philco | 03, 15, 17, 18, 48, 54, 59, 62, 69, 90 |
| Cinema | 97 | Philips | 15, 17, 18, 40, 48, 54, 62, 72 |
| Classic | 03 | Pioneer | 63, 66, 80, 91 |
| Concerto | 18 | Portland | 15, 18, 59 |
| Contec | 46 | Proton | 40 |
| Coronado | 15 | Quasar | 06, 66, 67 |
| Craig | 03, 05, 61, 82, 83, 84 | Radio Shack | 17, 48, 56, 60, 61, 75 |
| Croslex | 62 | RCA/Proscan | 18, 59, 67, 76, 77, 78, 92, 93, 94 |
| Crown | 03 | Realistic | 03, 19 |
| Curtis Mates | 59, 61, 63 | Sampo | 40 |
| CXC | 03 | Samsung | 00, 15, 16, 17, 40, 43, 46, 47, 48, 49, 59, 60, 98 |
| Daewoo | 02, 03, 04, 15, 16, 17, 18, 19, 20, 21, 22, 23, 24, 25, 26, 27, 28, 29, 30, 32, 34, 35, 36, 48, 59, 90 | Sanyo | 19, 61, 65 |
| Daytron | 40 | Scott | 03, 40, 60, 61 |
| Dynasty | 03 | Sears | 15, 18, 19 |
| Emerson | 03, 15, 40, 46, 59, 61, 64, 82, 83, 84, 85 | Sharp | 15, 57, 64 |
| Fisher | 19, 65 | Signature 2000 (M.Wards) | 57, 58 |
| Funai | 03 | Sony | 50, 51, 52, 53, 55 |
| Futuretech | 03 | Soundesign | 03, 40 |
| General Electric (GE) | 06, 40, 56, 59, 66, 67, 68 | Spectricon | 01 |
| Hall Mark | 40 | SSS | 18 |
| Hitachi | 15, 18, 50, 59, 69 | Sylvania | 18, 40, 48, 54, 59, 60, 62 |
| Inkel | 45 | Symphonic | 61, 95, 96 |
| JC Penny | 56, 59, 67, 86 | Tatung | 06 |
| JVC | 70 | Techwood | 18 |
| KTV | 59, 61, 87, 88 | Teknika | 03, 15, 18, 25 |
| KEC | 03, 15, 40 | TMK | 18, 40 |
| KMC | 15 | Toshiba | 19, 57, 63, 71 |
| LG (Goldstar) | 01, 15, 16, 17, 37, 38, 39, 40, 41, 42, 43, 44 | Vidtech | 18 |
| Luxman | 18 | Videch | 59, 60, 69 |
| LXI (Sears) | 19, 54, 56, 59, 60, 62, 63, 65, 71 | Wards | 15, 17, 18, 40, 48, 54, 60, 64 |
| Magnavox | 15, 17, 18, 48, 54, 59, 60, 62, 72, 89 | Yamaha | 18 |
| Marantz | 40, 54 | York | 40 |
| Matsui | 54 | Yupiteru | 03 |
| MGA | 18, 40 | Zenith | 58, 79 |
| | | Zonda | 01 |
| | | Dongyang | 03, 54 |

Connections

This section describes various methods of connecting the product to other external components. Before moving or installing the product, be sure to turn off the power and disconnect the power cord.

Attaching the Toroidal Ferrite Core to the Power Cord of the Main Unit

If you attach a Toroidal ferrite core to the power cord of the main unit, it will help to prevent RF interference from radio signals.

1. Pull the fixing tab of the Toroidal ferrite core to open it.
2. Make a loop twice in the main unit power cord.
3. Attach the Toroidal ferrite core to the main unit power cord as the figure shows and press it until it clicks.

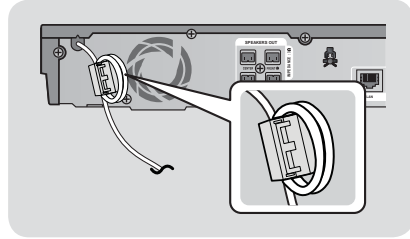

Connecting the Speakers

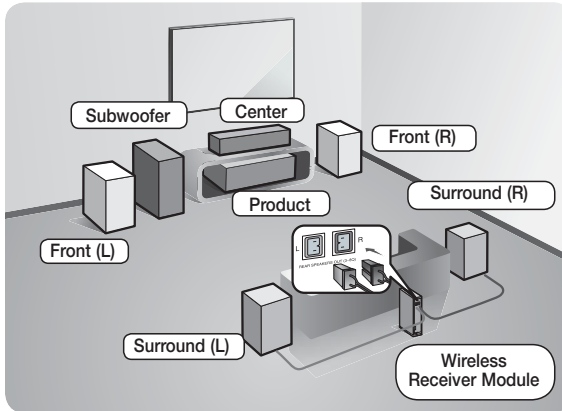

Position of the product

Place it on a stand or cabinet shelf, or under the TV stand.

Selecting the Listening Position

The listening position should be located about 2.5 to 3 times the distance of the TV's screen size away from the TV. For example, if you have a 46 inch screen, locate the listening position 115 to 138 inches (9.6 to 11.5 feet) from the screen.

| | |
|--------------------------|---|
| Front Speakers | Place these speakers in front of your listening position, facing inwards (about 45°) toward you. Place the front speakers so that their tweeters will be at the same height as your ear. Align the front face of the front speakers with the front face of the center speaker or place them slightly in front of the center speakers. |
| Center Speaker | It is best to install the Center Speaker at the same height as the front speakers. You can also install it directly over or under the TV. |
| Surround Speakers | Place these speakers to the side of your listening position. If there isn't enough room, place these speakers so they face each other. Position them about 2 to 3 feet (60 to 90cm) above your ear, facing slightly downward. * Unlike the front and center speakers, the surround speakers are used mainly for sound effects. Sound will not come from them all the time. |
| Subwoofer | The position of the subwoofer is not so critical. Place it anywhere you like. |

* Surround speakers must be connected to the wireless receiver module.

Connections

Speaker Components

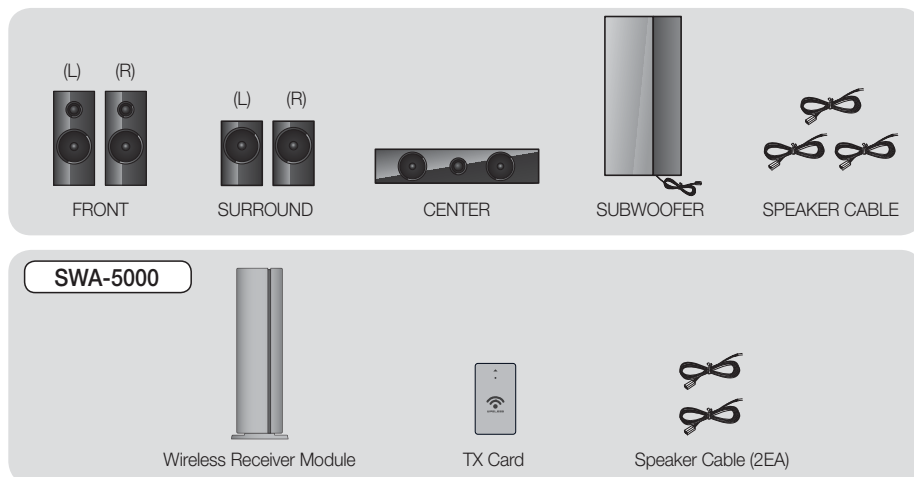

Connecting The Speakers

1. Match each speaker cable bundle to the correct speaker by matching the color coded plug on each bundle to the colored sticker on the bottom of each speaker.
2. To attach speaker wire to each speaker:
 - a. Press down the red tab on the back of the speaker, insert the red wire, and then release the tab.
 - b. Press down the black tab on the back of the speaker, insert the black wire, and then release the tab.
3. Connect the speaker wire plugs from each speaker to the back of the product by matching the colors of the speaker plugs to the colors of the speaker jacks.
4. With the product turned off, insert the TX card into the TX Card Connection (**WIRELESS**) on the back of the product.
 - Hold the TX card so that the label "WIRELESS" faces upward and insert the card into the port.
 - The TX card enables communication between the product and the wireless receiver module.
5. Connect the left and right surround speakers to the wireless receiver module. Again, match the color of the plugs to the jacks on the wireless receiver module.
6. Plug the power cord of the wireless receiver module into the wall outlet.
7. Turn on the product. The product and wireless receiver module will now communicate with each other and you will hear sound from the Surround speakers.

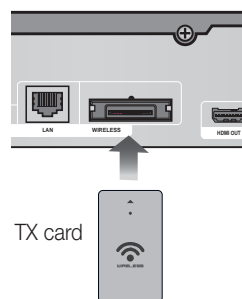
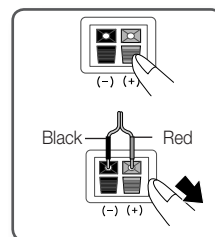

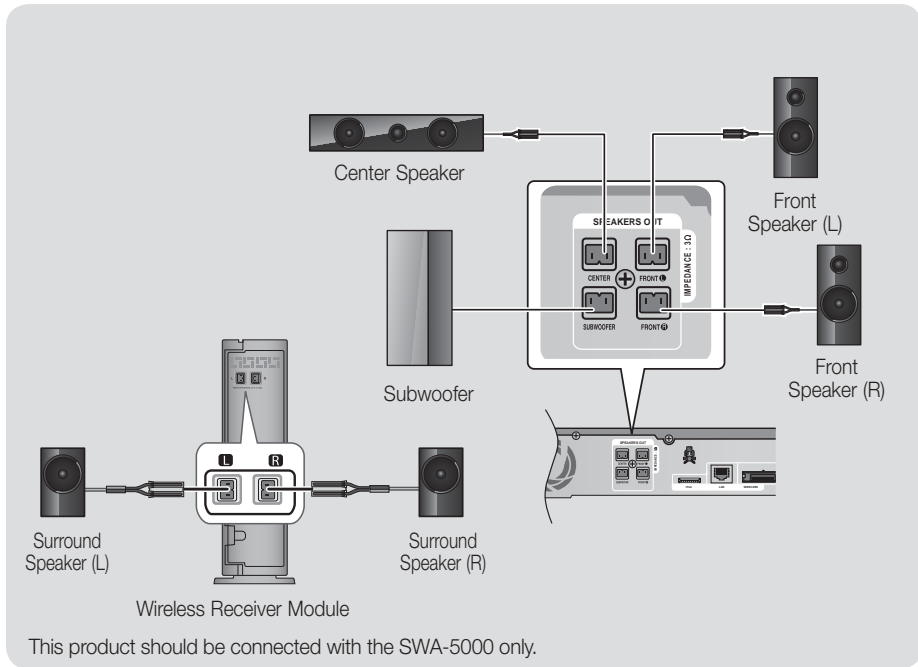

| CAUTION |

- ▶ If you want to install the product on the wall, fasten the screws or nails on the wall firmly and use the holes on the rear of speaker to install. However, when you install it, accessories (nails or screws) and installation is not provided by the company.
- ▶ Do not let children play with or near the speakers. They could get hurt if a speaker falls.
- ▶ When connecting the speaker wires to the speakers, make sure that the polarity (+/-) is correct.
- ▶ Keep the subwoofer speaker out of reach of children to prevent children from inserting their hands or alien substances into the duct (hole) of the subwoofer speaker.
- ▶ Do not hang the subwoofer on the wall through the duct (hole).
- ▶ Do not insert any other card except the TX card dedicated to the product.
If you insert a different TX card, you can damage the product and may not be able to remove the card easily.
- ▶ Do not insert the TX card upside down or in the reverse direction.
- ▶ Insert the TX card when the product is turned off. Inserting the card when it is turned on may cause a problem.
- ▶ The wireless receiving antenna is built into the wireless receiver module. Keep it away from water and moisture.
- ▶ For optimal listening performance, make sure that the area around the wireless receiver module location is clear of any obstructions.
- ▶ If you hear no sound from the wireless surround speakers, switch the mode to Dolby Pro Logic II.
- ▶ In 2-CH mode, you will hear no sound from the wireless surround speakers.

Connections

| NOTE |

- ▶ If you place a speaker near your TV set, the screen color may be distorted because of the magnetic field.
- ▶ Place the wireless receiver module at the rear of the listening position. If the wireless receiver module is too close to the product, sound from the speakers may be disrupted because of interference.
- ▶ If you use a device such as a microwave oven, wireless LAN Card, or any other device that uses the 2.4/5.8GHz frequencies near the product, sound from the speakers may be disrupted because of interference.
- ▶ The maximum transmission distance from the product to the wireless receiver module is about 33 feet (10m), but may vary depending on your operating environment. If a steel-concrete wall or metallic wall is between the product and the wireless receiver module, the system may not operate at all, because the radio wave cannot penetrate metal.
- ▶ If the product doesn't make a wireless connection, you need to run an ID Set between the product and wireless receiver module. With the product turned off, press "0" → "1" → "3" → "5" on the remote control. Turn on the wireless receiver module. Then, press and hold the "ID SET" button on the back of the wireless receiver module for 5 seconds, and then turn the product on.

Connecting the FM Antenna

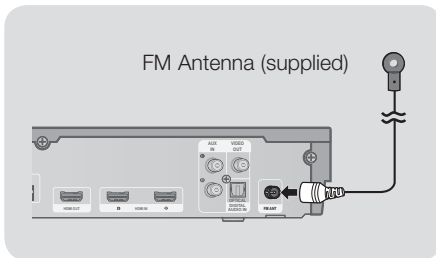

1. Connect the FM antenna supplied to the FM ANTENNA Jack.
2. Slowly move the antenna wire around until you find a location where reception is good, then fasten it to a wall or other rigid surface.

| NOTE |

- ▶ This product does not receive AM broadcasts.

Connecting to an iPod/iPhone

Using a USB Cable

Connect an iPod/iPhone using the USB cable to the front USB port.

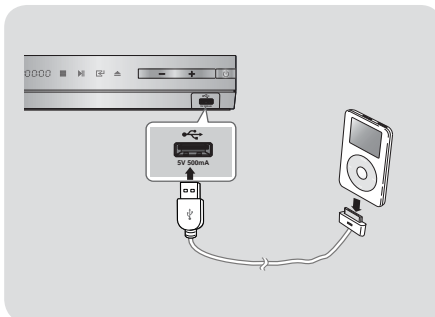

| NOTE |

- ▶ Make sure to connect the dock connector so that the label "▲" faces upward.

Using a Dock

To view a video from your iPod on your TV, you must also connect the Video Out jack on the product to the Video In jack on your TV. See page 19.

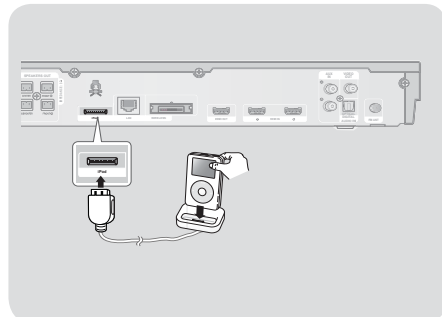

Connecting to a TV

Select either Method 1 or Method 2.

- If you have set the product's remote control to operate your TV, press the **TV SOURCE** button on the remote control, and then select the correct external source from the TV's source list (HDMI, Video In, etc.) to view video from the home theater.

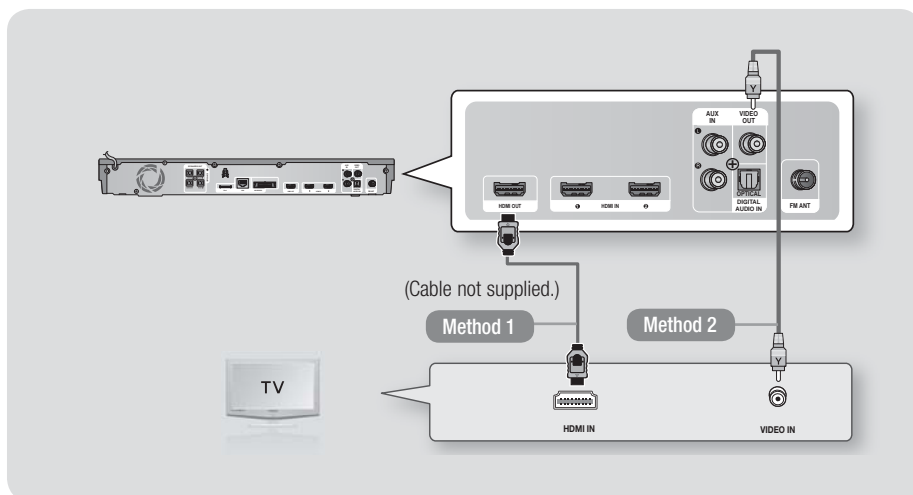

Method 1 Connecting to a TV with an HDMI Cable - Best Quality (Recommended)

Connect an HDMI cable (not supplied) from the HDMI OUT jack on the back of the product to the HDMI IN jack on your TV.

Method 2 Connecting to a TV with a Video Cable - Good Quality

Connect the supplied Video cable from the VIDEO OUT jack on the back of the product to the VIDEO IN jack on your TV.

| NOTE |

- ▶ The VIDEO Out jack always outputs in the 480i resolution regardless of the resolution set in the Setup menu.
- ▶ Do not connect the unit through a VCR. Video signals fed through VCRs may be affected by copyright protection systems and the picture will be distorted on the television.

Connections

Connecting to External Devices

To select the correct mode for an external device, press the **FUNCTION** button. Each time you press the button, the mode changes in this order : **BD/DVD → D. IN → AUX → R. IPOD → HDMI1 → HDMI2 → FM**

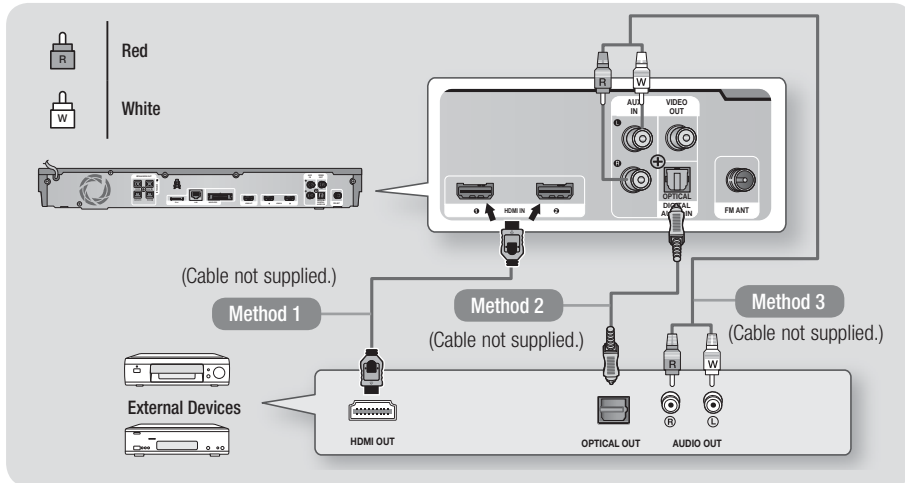

Method 1 HDMI IN : Connecting to an External Component with an HDMI Cable

Connect an HDMI cable (not supplied) from the HDMI IN jack on the back of the product to the HDMI OUT jack on your digital device. ⇒ Select the **HDMI1** or **HDMI2** mode.

Method 2 OPTICAL : Connecting an External Digital Audio Component

To connect the digital audio output of digital signal components such as Cable Boxes and Satellite Receivers (Set-Top-Boxes).

Using a digital optical cable (not supplied), connect the Optical Digital Audio In jack on the product to the Digital Optical Out jack of the external digital device using a digital optical cable.

⇒ Select the **D. IN** mode.

Method 3 AUX IN : Connecting an External Analog Component

Using an RCA audio cable (not supplied), connect the AUDIO In jack on the product to the AUDIO Out jack on the external analog component. ⇒ Select the **AUX** mode.

- Be sure to match the colors on the cable plugs to the colors on the input and output jacks.

| NOTE |

- ▶ To see video from your Cable Box/Satellite receiver, you must connect its video output directly to your TV.
- ▶ This system supports Digital sampling frequencies of 32 kHz or higher from external digital components.
- ▶ This system supports only DTS and Dolby Digital audio. MPEG audio, a bitstream format, is not supported.

Connecting to a Network Router

You can connect your product to your network router using one of the methods illustrated below.

Wired Network

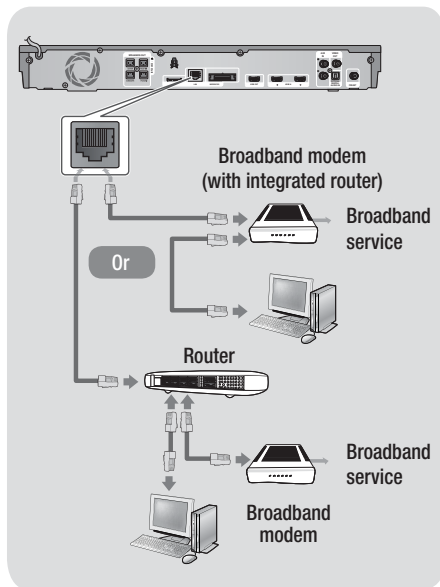

| NOTE |

- ▶ Internet access to Samsung's Software Update server may not be allowed, depending on the router you use or your ISP's policy. For more information, contact your ISP (Internet Service Provider).
- ▶ DSL users, please use a router to make a network connection.
- ▶ To use the AllShare Play function, you must connect your PC to your network as shown in the illustrations on the left.
The connection can be wired or wireless.

Wireless Network

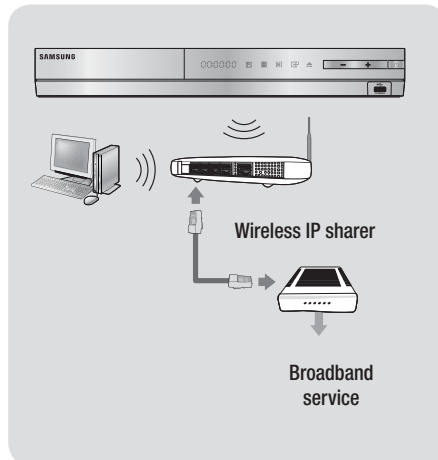

| NOTE |

- ▶ If your wireless IP router supports DHCP, this product can use a DHCP or static IP address to connect to the wireless network.
- ▶ Set your wireless IP router to Infrastructure mode. Ad-hoc mode is not supported.
- ▶ The product supports only the following wireless security key protocols:
 - WEP (OPEN/SHARED), WPA-PSK (TKIP/AES), WPA2-PSK (TKIP/AES)
- ▶ Select a channel on the wireless IP router that is not currently being used. If the channel set for the wireless IP router is currently being used by another device nearby, it will result in interference and communication failure.
- ▶ If you select the Pure High-throughput (Greenfield) 802.11n mode and set the Encryption type on your router or AP to WEP, TKIP or TKIP-AES (WPS2Mixed), the product will not support a connection in compliance with new Wi-Fi certification specifications.
- ▶ Wireless LAN, by its nature, may cause interference, depending on the operating conditions (AP performance, distance, obstacles, interference by other radio devices, etc).

Settings

The Initial Settings Procedure

- The Home menu will not appear if you do not configure the initial settings.
- The OSD (On Screen Display) may change in this product after you upgrade the software version.
- The access steps may differ depending on the menu you selected.

1. Turn on your TV after connecting the product, and then turn on the product. When you turn on the product for the first time, the product automatically displays the Initial Settings Language screen.

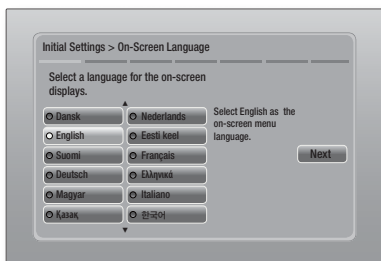

2. Use the ▲▼◀▶ buttons on the remote to select the desired language, and then press the **OK** button twice. The Start screen appears.
3. Press the **OK** button to start setup. The Network Settings screen appears.

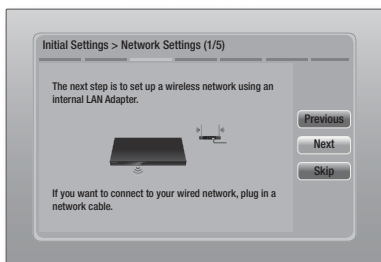

4. Press the **OK** button to set up the product's wireless network connection or select **Skip**, and then press the **OK** button to skip network setup. If you selected **Skip**, go to Step 12.

| NOTE |

- ▶ The product starts the wireless network connection procedure by default. If you want to set up a wired connection, select **Skip**, and then go to "Configuring Your Network Connection" on page 30 after you have completed the Initial Settings Procedure.
 - ▶ If you skip wireless network setup here, go to "Wireless Network" on page 31 to set up the product's wireless network connection later.
5. The product searches for and then displays all available wireless router network connections.

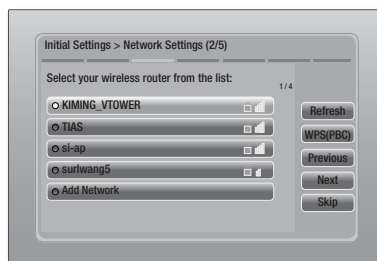

6. Use the ▲▼ buttons to select a router, and then press the **OK** button. The **Next** button is highlighted.
7. Press the **OK** button to continue. The Security Key screen appears.



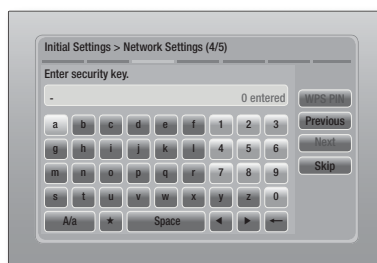

| NOTE |

- ▶ If you have a WPS(PBC) compatible router, select WPS(PBC) instead, press the **OK** button, and then follow the directions on the screen. When done, go to Step 10.





8. Enter your network's security key. When done, use the ▲▼◀▶ buttons to select **Next**, and then press the **OK** button.

| NOTE |

- ▶ Enter numbers by pressing the number buttons on your remote.
 - ▶ Enter letters by selecting a letter using the ▲▼◀▶ buttons, and then press the  button.
 - ▶ To display capital letters (or redisplay small letters if capital letters are displayed), select **A/a**, and then press the  button.
 - ▶ To display symbols and punctuation, select **★**, and then press the  button. To redisplay letters, select **★**, and then press the  button.
9. If the connection is successful, the Connection Complete screen appears. Select **Next**, and then press the  button. The Software Update screen appears.



| NOTE |

- ▶ If the connection is not successful, select **Next**, and then press the  button. After you have completed the Initial Settings procedure, go to "Wireless Network" on page 31 to set up the product's wireless network connection.
10. To upgrade the software, select **Update now**, and then press the  button. To skip the upgrade, select **Update later**, press the  button, and go to Step 12.

| NOTE |

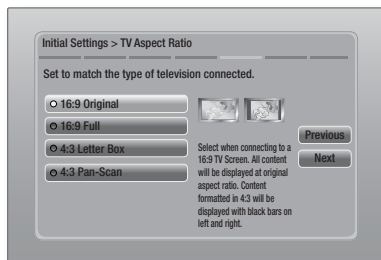
- ▶ If you skipped network set up, you must skip Software Update also.
11. If there is a Software Update available, the product downloads and installs the upgrade. This can take some time. If there is no Software Update available, the "**There are no new software updates for you to download. You already have the most up to date version.**" message appears. And then press the  button. The TV Aspect Ratio screen appears.



12. Using the ▲▼ buttons, select the aspect ratio that matches your screen, and then press the  button. Select **Next**, and then press the  button.

You have four choices:

16:9 Original - For widescreen TVs. Displays widescreen pictures in their original 16:9 format and 4:3 pictures (the old, standard format) in 4:3 pillar box format with black bars on the left and right.

16:9 Full - For widescreen TVs. Displays widescreen pictures in their original 16:9 format and expands 4:3 pictures to fill the 16:9 screen.

4:3 Letter Box - For older, standard screen analog TVs. Displays 4:3 pictures in full screen and 16:9 pictures in letter box format that retains the 16:9 aspect ratio but puts black bars above and below the picture.

4:3 Pan-Scan - For older, standard screen analog TVs. Displays 4:3 pictures in full screen and 16:9 pictures in Pan-Scan format that fills the screen, but cuts off the left and right sides of the picture and enlarges the middle vertically.

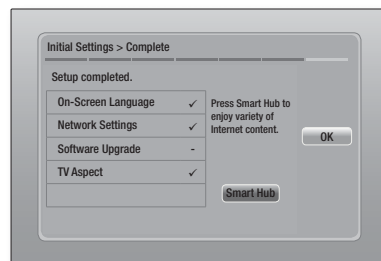

13. The Setup completed screen appears. Check the settings to confirm they are correct. Select **OK**, and then press the  button. The Home screen appears.

| NOTE |

- ▶ If you want to display the Initial Setting screen again and make changes, select the Reset option. (See page 29)
- ▶ If you use an HDMI cable to connect the product to an AnyNet+ (HDMI-CEC)-compliant Samsung TV and 1.) You have set the AnyNet+ (HDMI-CEC) feature to ON in both the TV and the product and 2.) You have set the TV to a language supported by the product, the product will select that language as the preferred language automatically.

English **23** |

Settings

The Home Screen

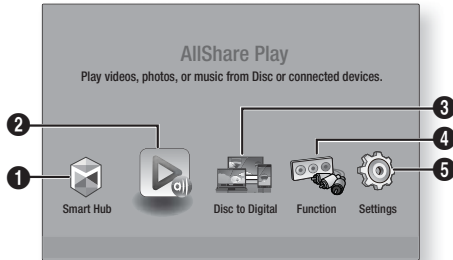

| | |
|---|--|
| 1 | Smart Hub. Starts Smart Hub. From Smart Hub, you can access Netflix, Pandora, YouTube, games, and other apps. |
| 2 | AllShare Play. Play videos, photos or music content from Disc, USB, PC or mobile devices. |
| 3 | Disc to Digital. Access you movie collection via cloud storage anytime, any place without your DVD disc. |
| 4 | Function. Select the audio/video input source. |
| 5 | Settings. Set various functions to suit your personal preferences. |

■ Selecting an Option on the Home Screen

- To select an option on the Home screen, move the cursor using the ◀▶ buttons until it highlights the option of your choice, and then press the button.

Accessing the Settings Screen

- Select **Settings** on the Home screen, and then press . The Settings screen appears.

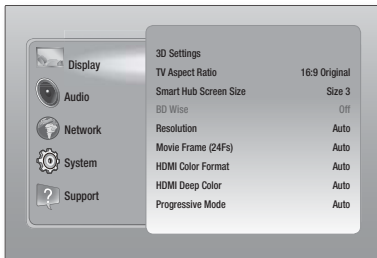

- To access the menus, sub-menus, and options on the Settings screen, please refer to the remote control illustration below.

| NOTE |

- If you leave the product in the stop mode for more than 5 minutes without using it, a screen saver will appear on your TV. If the product is left in the screen saver mode for more than 20 minutes, the power will automatically turn off.

Buttons on the Remote Control Used for the Settings Menu

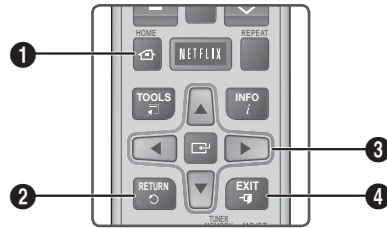

| | |
|---|---|
| 1 | HOME Button : Press to move to the Home screen. |
| 2 | RETURN Button : Return to the previous menu. |
| 3 | (Enter) / DIRECTION Button : <ul style="list-style-type: none"> Press to move the cursor or select an item. Press the button to activate the currently selected item or confirm a setting. |
| 4 | EXIT Button : Press to exit the current menu. |

| NOTE |

- The button on the product's front panel can be used for same purpose as the button on the remote control.

Detailed Function Information

Each Settings function, menu item, and individual option is explained in detail on-screen. To view an explanation, use the buttons to select the function, menu item, or option.

The explanation will usually appear on the right of the screen. A short description of each Settings function starts on the next page. Additional information on some of the functions is also in the Appendix of this manual.

Settings Menu Functions

| | | |
|---------|-----------------------|--|
| Display | 3D Settings | <p>Set up the 3D related functions.</p> <ul style="list-style-type: none"> ✓ 3D Blu-ray Playback Mode: Select whether to play a Blu-ray Disc with 3D contents in 3D Mode. If you move to the Home or Smart Hub Home menu while in 3D mode, the product will switch to 2D automatically. ✓ Screen Size: Enter the size of the TV attached to the product. The product will automatically adjust the 3D output to the screen size of the TV. |
| | TV Aspect Ratio | Lets you adjust the output of the product to the screen size of your TV. See page 23, Step 12 for a description of the screen size options. |
| | Smart Hub Screen Size | Lets you select the optimal size for the Smart Hub Screen. |
| | BD Wise | BD Wise is Samsung's latest inter-connectivity feature. When you connect a Samsung product and a Samsung TV with BD Wise to each other via HDMI, and BD Wise is on in both the product and TV, the product outputs video at the video resolution and frame rate of the Blu-ray/DVD Disc. |
| | Resolution | Lets you set the output resolution of the HDMI video signal to Auto, 1080p, 1080i, 720p, 480p . If Composite is connected, the resolution supports only 480i . The number indicates the number of lines of video per frame. The i and p indicate interlaced and progressive scan, respectively. The more lines, the higher quality. |
| | Movie Frame (24Fs) | <p>Setting the Movie Frame (24Fs) feature to Auto lets the product adjust its HDMI output to 24 frames per second automatically for improved picture quality if attached to a 24Fs compatible TV.</p> <ul style="list-style-type: none"> • You can enjoy the Movie Frame (24Fs) feature only on a TV supporting this frame rate. • Movie Frame is only available when the product is in the HDMI 1080i or 1080p output resolution modes. |
| | HDMI Color Format | Lets you set the color space format for the HDMI output to match the capabilities of the connected device (TV, monitor, etc). |
| | HDMI Deep Color | Lets you set the product to output video from the HDMI OUT jack with Deep Color. Deep Color provides more accurate color reproduction with greater color depth. |
| | Progressive Mode | Lets you improve picture quality when viewing DVDs. |

Settings

| | | |
|--------------|------------------------------|--|
| Audio | Speaker Settings | You can set the speaker options. |
| | Equalizer | Let you configure the Equalizer settings manually. |
| | Smart Volume | Lets you set the product so that the volume remains stable when a scene change occurs or when you change the channel. |
| | Speaker Selection | Lets you select which speakers you want active, either the TV's speakers or the Home theater's speakers. |
| | Audio Return Channel | <p>Lets you direct the sound from the TV to the Home Theater speakers. Requires an HDMI connection and an Audio Return Channel (ARC) compatible TV.</p> <ul style="list-style-type: none"> • When Audio Return Channel set to on, use HDMI Cable to connect the product to the TV. At this time, optical input does not work. • When Audio Return Channel set to auto, use HDMI Cable to connect the product to the TV. At this time, ARC and optical input is selected automatically. |
| | Digital Output | Let you set the Digital Output to match the capabilities of the AV receiver you've connected to the product. For more details, please refer to the digital output selection table. (See page 57) |
| | Dynamic Range Control | <p>Lets you apply dynamic range control to Dolby Digital, Dolby Digital Plus, and Dolby True HD audio.</p> <ul style="list-style-type: none"> ✓ Auto: Automatically controls the dynamic range of Dolby TrueHD audio, based on information in the Dolby TrueHD soundtrack. Also turns dynamic range control on for Dolby Digital and Dolby Digital Plus. ✓ Off: Leaves the dynamic range uncompressed, letting you hear the original sound. ✓ On: Turns dynamic range control on for all three Dolby formats. Quieter sounds are made louder and the volume of loud sounds is reduced. |
| | Audio Sync | When the product is attached to a digital TV, lets you adjust the audio delay so that the audio syncs with the video. You can set the delay between 0 and 300 milliseconds. |

| | | |
|----------------|--------------------------|---|
| Network | Network Settings | For more information about Network Settings and network functions, see "Networks and the Internet" starting on page 30. |
| | Network Status | Let you check whether a connection to the network and the Internet have been established. |
| | Wi-Fi Direct | Lets you connect a Wi-Fi Direct device to the product using a Peer-to-Peer network, without a wireless router. You can use the device to control the product. |
| | Soft AP | Lets you connect other types of Wi-Fi devices to the product wirelessly. Requires that you create a security key which you must enter into the other Wi-Fi devices when you are connecting them to the network. |
| | AllShare Settings | Lets you permit external devices such as smart phones to connect to the product and share content with or control the product. |
| | Device Name | Lets you assign an identifying name to the product. You use this name to identify the product when you are connecting external Wi-Fi devices (smart phones, tablets, etc.) to it. |
| | BD-Live Settings | Lets you allow, limit, or prohibit an Internet connection for the BD-Live service. |

Settings

| | | |
|---------------|---------------------------|--|
| System | Initial Settings | Lets you re-run the Initial Settings procedure. See page 22 for details. |
| | Device Manager | <p>You can connect a wireless USB keyboard or mouse to the USB port on the front of the product.</p> <p>✓ Keyboard Settings: Lets you configure a wireless USB keyboard connected to the product.</p> <p> NOTE </p> <ul style="list-style-type: none"> ▶ You can use the keyboard only when a QWERTY keyboard screen or window appears in the Web Browser. <p>✓ Mouse Settings: Lets you configure a wireless USB mouse connected to the product. You can use the mouse in the product's menu in the same way you use a mouse on your PC.</p> <ul style="list-style-type: none"> ▪ To use a mouse with the product's menu: <ol style="list-style-type: none"> 1 . Connect the USB mouse to the product. 2 . Click the primary button you selected in Mouse Settings. The Simple Menu appears. 3 . Click the menu options you want. <p> NOTE </p> <ul style="list-style-type: none"> ▶ Depending on the model of the USB HID keyboard and mouse may not be compatible with your product. ▶ Some HID keyboard keys may not work. ▶ Wired USB keyboards are not supported. ▶ Some applications may not be supported. ▶ If a wireless HID Keyboard does not operate because of interference, move the keyboard closer to the product. |
| | Anynet+ (HDMI-CEC) | Anynet+ is a convenient function that offers linked operations with other Samsung products that have the Anynet+ feature and lets you control those products with one Samsung TV remote. To operate this function, you must connect this product to an Anynet+ Samsung TV using an HDMI cable. |
| | Language | <p>You can select the language you prefer for the On-Screen menu, disc menu, subtitles, etc.</p> <ul style="list-style-type: none"> • The language you select for the disc menu, disc audio, or subtitles will only appear if it is supported on the disc. |

| | | |
|----------------|--------------------------|--|
| | Security | <p>The default PIN is 0000. Enter the default PIN to access the security function if you haven't created your own password.</p> <ul style="list-style-type: none"> ✓ BD Parental Rating: Prevents playback of Blu-ray Discs with a rating equal to or above a specific age rating you enter unless the PIN is entered. ✓ DVD Parental Rating: Prevents playback of DVDs with a rating above a specific numerical rating you select unless the PIN is entered. ✓ Change PIN: Change the 4-digit PIN used to access security functions. <ul style="list-style-type: none"> ▪ If you forget your PIN <ol style="list-style-type: none"> 1. Remove any disc or USB storage device. 2. Press and hold the  button on the front panel for 5 seconds or more. All settings will revert to the factory settings. <p> NOTE </p> <ul style="list-style-type: none"> ▶ When the factory default settings are restored, all the user stored BD data will be deleted. |
| | General | <p>You can specify the display brightness and time zone.</p> <ul style="list-style-type: none"> ✓ Front Display: Lets you change the brightness of the front panel. ✓ Time Zone: You can specify the time zone that is applicable to your area. ✓ Menu Transparency: Adjust the transparency of the menu box. |
| Support | Software Update | For more information about the Software Update function, see "Upgrading Software" on page 34. |
| | Contact Samsung | Provides contact information for assistance with your product. |
| | Remote Management | When activated, lets Samsung Call Center agents diagnose and fix problems with the product remotely. Requires an active Internet connection. Remote Management service might not be available in some countries. |
| | Reset | All settings will revert to the default except for the network and Smart Hub settings. The default security password is 0000. |

Settings

Networks and the Internet

When you connect this product to a network, you can use network based applications and functions such as Smart Hub and BD-LIVE, and upgrade the product's software through the network connection. For more information about accessing and using Internet services, see the Network Services chapter of this manual on pages 49-52. Instructions for configuring the network connection start below.



Configuring Your Network Connection

Before you begin, contact your ISP to find out if your IP address is static or dynamic. If it is dynamic, and you have a wired or wireless network, we recommend using the Automatic configuration procedures described below.

If you are connecting to a wired network, connect the product to your router using a LAN cable before you start the configuration procedure.

If you are connecting to a wireless network, disconnect any wired network connection before you begin.

To begin configuring your network connection, follow these steps:

1. In the Home screen, select **Settings**, and then press the  button.
2. Select **Network**, and then press the  button.
3. Select **Network Settings**, and then press the  button.
4. Go to the instructions for Wired networks starting below or the instructions for Wireless networks starting on page 31.

Wired Network

□ Wired – Automatic

After following Steps 1 to 3 above:

1. Select **Start** in the Network Settings screen, and then press the  button. The product detects the wired connection, verifies the network connection and then connects to the network.



□ Wired - Manual

If you have a static IP address or the Automatic procedure does not work, you'll need to set the Network Settings values manually.

After following Steps 1 to 3 above:

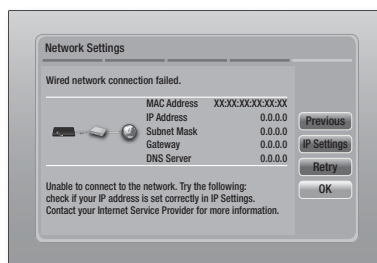
1. Select **Start** in the Network Settings screen, and then press the  button. The Network Status screen appears. The product attempts to verify the network connection and fails.



2. Select **IP Settings** on the right of the screen, and then press  button. The IP Settings screen appears.
3. Select the **IP Mode** field, and then set it to **Manual**.
4. Use the number keypad on your remote to enter the Network values. Use the   buttons on the remote to move from entry field to entry field.

| NOTE |

- ▶ You can get these values from your Internet provider. You can also view these values on most Windows computers. For instructions, see "Getting the Network Settings Values." on this page.
5. When done, highlight **OK**, and then press  button. The product verifies the network connection and then connects to the network.

< Getting the Network Settings Values >

You can view your Network Settings values on most Windows computers. To view the Network Settings values, follow these steps:

- Windows XP
1. Right click the Network icon on the bottom right of the Windows desktop.

2. In the pop-up menu, click Status.
3. On the dialog that appears, click the Support tab.
4. On the Support tab, click the Details button.
5. The Network settings are displayed.

- Windows 7

1. Click the Network icon on the bottom right of the Windows desktop.
2. In the pop-up menu, click Network and Sharing Center.
3. On the dialog that appears, click the Local Area Connection or Wireless Network Connection depending on your network connection.
4. On the Support tab, click the Details button. The Network settings are displayed.

| NOTE |

- ▶ Depending on your Windows version, the information may differ.

Wireless Network

You can setup a wireless network connection in three ways:

- Wireless Automatic
- Wireless Manual
- WPS(PBC)



When you configure the wireless network connection, any wireless network devices currently connected through the product or, if applicable, the product's current wired connection, will be disconnected.

□ Wireless (General) - Automatic

After following Steps 1 to 3 in "Configuring Your Network Connection" on page 30.

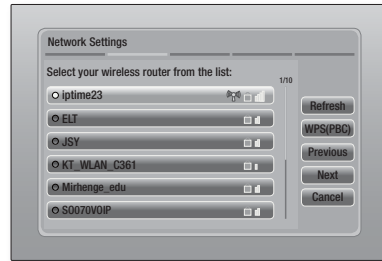
1. Select **Start** in the Network Settings screen, and then press the  button. The product searches for and then displays a list of the available networks.



2. Select the desired network, and then press the  button.
3. Select **Next**, and then press the  button again.
4. On the Security screen, enter your network's Security Code or Pass Phrase. Enter numbers directly using the number buttons on your remote control. Enter letters by selecting a letter with an arrow button, and then pressing  button.
5. When done, select **Next** at the right of the screen. The product verifies the network connection and then connects to the network.



| NOTE |

- ▶ You should be able to find the Security Code or Pass Phrase on one of the set up screens you used to set up your router or modem.







□ Wireless (General) - Manual

If you have a static IP address or the Automatic procedure does not work, you'll need to set the Network Settings values manually.



After following Steps 1 to 3 in "Configuring Your Network Connection" on page 30.

1. Select **Start** in the Network Settings screen, and then press the  button. The product searches for and then displays a list of the available networks.
2. Select the desired network or the **Add Network**, and then press the  button.
3. Select **Next**, and then press the  button again.

Settings

- If you select the **Add Network**, enter your wireless router's name to connect. Enter numbers directly using the number buttons on your remote control. Enter letters by selecting a letter with the ▲▼◀▶ buttons, and then pressing the  button. Select **Next**, and then press the  button again. You can select security type, and then select **Next**, and then press the  button again.
- On the Security screen, enter your network's Security Code or Pass Phrase. Enter numbers directly using the number buttons on your remote control. Enter letters by selecting a letter with the ▲▼◀▶ buttons, and then pressing the  button.
- When done, select **Next** at the right of the screen, and then press the  button.
- The Network Status screen appears. The product attempts to verify the network connection and fails.
- Select **IP Settings** on the right of the screen, and press the  button. The IP Settings screen appears.
- Select the **IP Mode** field, and then set it to **Manual**.
- Use the number keypad on your remote to enter the Network values. Use the ▲▼◀▶ buttons on the remote to move from entry field.

| NOTE |

- You can get these values from your Internet provider. You can also view these values on most Windows computers. For instructions, see "Getting the Network Settings Values." on page 30.
- When done, highlight **OK**, and then press  button. The Network Status screen appears. The product verifies the network connection and then connects to the network. When it is done, highlight **OK**, and then press  button.

□ WPS(PBC)

One of the easiest ways to set up the wireless network connection is using the WPS(PBC) function. If your wireless router has a WPS(PBC) button, follow these steps:

After following Steps 1 to 3 in "Configuring Your Network Connection" on page 30.

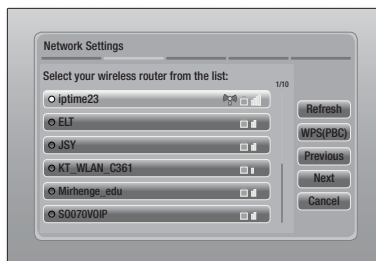

- Select **Start** in the Network Settings screen, and then press the  button.



- Select **WPS(PBC)**, and then press the  button.
- Press the **WPS(PBC)** button on your router within two minutes. Your product automatically acquires all the network settings values it needs and connects to your network. The Network Status screen appears. The product connects to the network after the network connection is verified.

Wi-Fi Direct

The Wi-Fi Direct function allows you to connect Wi-Fi Direct devices to the product and each other using a peer-to-peer network, without a wireless router.

- Turn on the Wi-Fi direct device and activate its Wi-Fi Direct function.
- In the Home screen, select **Settings**, and then press the  button.
- Select **Network**, and then press the  button.
- Select **Wi-Fi Direct**, and then press the  button. The Wi-Fi Direct devices that you can connect appear.





- You have three ways to complete the Wi-Fi connection:
 - Through the Wi-Fi device.
 - Through the product using PBC.
 - Through the product using a PIN.

Each is covered below.



Through the Wi-Fi Device

- On the Wi-Fi device, follow the procedure on the device for connecting to another Wi-Fi Direct device. See the device's user manual for instructions.
- When you have completed the procedure, you should see a pop-up on your TV screen saying that a device that supports Wi-Fi Direct has requested to connect. Select **OK**, and then press the  button to accept.
- The Connecting pop-up appears, followed by the Connected pop-up. When it closes, you should see the device listed on the Wi-Fi Direct screen as connected.

Through the Product Using PBC

- Select the Wi-Fi Direct device you want to connect to this product, and then press the  button. The PBC/PIN pop up appears.
- Select **PBC**, and then press the  button. The PBC pop-up appears.
- Press the **PBC** button on the Wi-Fi Direct device within 2 minutes.
- The Connecting pop-up appears, followed by the Connected pop-up. When it closes, you should see the device listed on the Wi-Fi Direct screen as connected.

Through the Product Using a PIN

- Select the Wi-Fi Direct device you want to connect to this product, and then press the  button. The PBC/PIN pop up appears.
- Select **PIN**, and then press the  button. The PIN pop-up appears.
- Note the PIN code in the pop-up, and then enter it into the appropriate field in the Wi-Fi Direct device you want to connect.
- The Connecting pop-up appears, followed by the Connected pop-up. When it closes, you should see the device listed on the Wi-Fi Direct screen as connected.





| NOTE |

- The wired or wireless network connection will be disconnected when you use the Wi-Fi Direct function.





Soft AP

Soft AP lets you connect other Wi-Fi devices to your network through the product and lets them access the Internet.

It requires that you create a security key which you must enter into the other Wi-Fi devices when you are connecting them to the network.

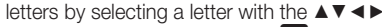
- In the Home screen, select **Settings**, and then press the  button.
- Select **Network**, and then press the  button.
- Select **Soft AP**, and then press the  button.
- Select **On** or **Off**, and then press the  button.



< To Set the Soft AP Security Key >

- On the Soft AP screen, select **Security Key**, and then press the  button. The Security Key screen appears.
- On the Security key screen, enter a security key. Enter numbers directly using the number buttons on your remote control. Enter letters by selecting a letter with the  buttons, and then pressing the  button.
- When done, use the  buttons to move to **DONE** at the bottom of the screen, and then press the  button.



When you connect a Wi-Fi device through the connection procedure on the device, you must enter the security key you created here into the appropriate field.

AllShare Settings

The AllShare Settings screen lists your network connected AllShare devices and their IP addresses. Through this screen, you can allow a device to access the product, deny access, or delete the device from the AllShare list.

- In the Home screen, select **Settings**, and then press the  button.
- Select **Network**, and then press the  button.





Settings

3. Select **AllShare Settings**, and then press the  button.
4. Select a device, and then press the  button. The AllShare Settings pop-up appears.
5. Select **Allow**, **Deny**, or **Delete** from List, and then press the  button.

The AllShare Settings screen only displays devices if you have established networked connections to AllShare devices. For more information about AllShare networked devices, see pages 36~37.

Upgrading Software

The Software Update menu allows you to upgrade the product's software for performance improvements or additional services.

- Never turn the product off or back on manually during the update process.
1. In the Home menu, select the **Settings**, and then press the  button.
 2. Select **Support**, and then press the  button.
 3. Select **Software Update**, and then press the  button.
 4. Select one of the following methods:
 - **Online**
 - **By USB**
 - **By Disc**
 - **By Downloaded**
 - **Standby Mode Upgrade**
 5. Press the  button.
Directions for each method begin below.

| NOTE |

- ▶ The upgrade is complete when the product turns off, and then turns on again by itself.
- ▶ Samsung Electronics takes no legal responsibility for product malfunction caused by an unstable Internet connection or consumer negligence during a Software Update.
- ▶ If you want to cancel the upgrade while the upgrade software is downloading, press the  button.

Online

Your product must be connected to the Internet to use the Online function.

1. Select **Online**, and then press the  button. The Connecting to Server message appears.
2. If there is a download available, the Download pop-up appears with a progress bar and the download starts.
3. When the download is complete, the Upgrade Query window appears with three choices: **Update now**, **Update later** or **Don't update**.
4. If you select **Update now**, the product upgrades the software, turns off, and then turns on automatically.
5. If you do not make a selection in one minute or select **Update later**, the product stores the new upgrade software. You can upgrade the software later using the **By Downloaded** function.
6. If you select **Don't update**, the product cancels the upgrade.

By USB

1. Visit www.samsung.com.
2. Click **SUPPORT** on the top right of the page.
3. Enter the product's model number into the search field, and then click **Find Product**.
4. Click **Get downloads** in the center of the page below the Downloads header.
5. Click **Firmware** in the center of the page.
6. Click the **ZIP** icon in the File column on the right side of the page.
7. Click **OK** in the pop-up that appears to download and save the firmware file to your PC.
8. Unzip the zip archive to your computer. You should have a single folder with the same name as the zip file.
9. Copy the folder to a USB flash drive.
10. Make sure no disc is inserted in the product, and then insert the USB flash drive into the USB port of the product.

- 11 . In the product's menu, go to **Settings > Support > Software Update.**
- 12 . Select **By USB.**

| NOTE |

- ▶ There should be no disc in the product when you upgrade the software using the USB Host jack.
- ▶ When the Software Update is done, check the software details in the **Software Update** menu.
- ▶ Do not turn off the product during the Software Update. It may cause the product to malfunction.
- ▶ Software Updates using the USB Host jack must be performed with a USB flash memory stick only.

By Disc

- 1 . Visit www.samsung.com.
- 2 . Click **SUPPORT** on the top right of the page.
- 3 . Enter the product's model number into the search field, and then click **Find Product.**
- 4 . Click **Get downloads** in the center of the page below the Downloads header.
- 5 . Click **Firmware** in the center of the page.
- 6 . Click the **ZIP** icon in the File column on the right side of the page.
- 7 . Click **OK** in the pop-up that appears to download and save the firmware file to your PC.
- 8 . Unzip the zip archive to your computer. You should have a single .RUF file.
- 9 . Write the RUF file onto a disc. We recommend a CD-R or DVD-R.
- 10 . Finalize the disc before you remove it from your computer.
- 11 . Insert the disc into the product.
- 12 . In the product's menu, go to **Settings > Support > Software Update.**
- 13 . Select **By Disc.**

| NOTE |

- ▶ When the system upgrade is done, check the software details in the **Software Update** menu.
- ▶ Do not turn off the product during the Software Update. It may cause the product malfunction.

By Downloaded

The By Downloaded option lets you upgrade using a file the product downloaded earlier that you decided not to install immediately.

- 1 . If upgrade software has been downloaded, you will see the software version number to the right of By Downloaded.
- 2 . Select **By Downloaded**, and then press the  button.
- 3 . The product displays a message asking if you want to upgrade. Select **Yes.** The product begins the upgrade.
- 4 . When the update is complete, the product turns off automatically, and then turns on.

| NOTE |

- ▶ When the system upgrade is done, check the software details in the **Software Update** menu.
- ▶ Do not turn off the product during the Software Update. It may cause the product to malfunction.

Standby Mode Upgrade

You can set the Standby Mode Upgrade function so that the product downloads new upgrade software when it is in Standby mode.

In Standby mode, the product is off, but its Internet connection is active. This allows the product to download upgrade software automatically, when you are not using it.

- 1 . Press the **▲▼** buttons to select **Standby Mode Upgrade**, and then press the  button.
- 2 . Select **On** or **Off.**
If you select **On**, the product will automatically download new upgrade software when it is in Standby mode with the power off. If it downloads new upgrade software, the product will ask you if you want to install it when you turn the product on.

| NOTE |

- ▶ To use Standby Mode Upgrade function, your product must be connected to the Internet.
- ▶ If this function does not appear, you can upgrade to the latest software and use it.

Media Play

Your Blu-ray product can play Disc and USB contents and the contents located on your PC, DLNA compatible mobile phone, or NAS using the AllShare Play function. For more information about AllShare Play, refer to page 39.

The AllShare Play Screen

To access the AllShare Play screen, select the AllShare Play icon on the Main screen, and then press the  button.

Using the AllShare Play Screen

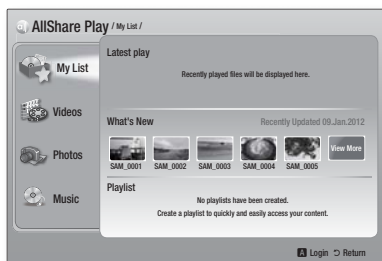









When the AllShare Play screen appears, it displays My List and a list of content types - Videos, Photos, and Music - on the left side. On the right, it displays, by default, the content in My List: a list of recently played or viewed items, a list of the newest items you have viewed or listened to, and your most recent Playlist. If you have never played or viewed any items, or created a Playlist, this area will be empty.

□ Playing My List Items







To play displayed My List items, you must have the source of the items connected to or inserted in the product. For example, if recently played My List photos came from a DVD disc, you must have that disc in the product to view them.

To play or view My List items, perform one of the actions below:

- Use the   buttons to select an item you want to view or play, and then press the  button. To view or play another item, press the **RETURN** () button, and then repeat the process described in the first sentence.

- Use the   buttons to select an item, press the **TOOLS** button to display the Tools menu, select **Play**, and then press the  button. To view or play another item, press the **RETURN** () button, and then repeat the process described in the first sentence.

□ Playing Video, Photo, or Music Content

1. Make sure that the source of the content you want to play or view is connected to or inserted into the product.
2. Use the   buttons to select **Videos**, **Photos**, or **Music**, and then press the  button. The first source selection on the right side is highlighted.
3. Use the   buttons to select the source of the content, and then press the  button.

| NOTE |

- ▶ Sources displayed for each content type may differ.
4. To control the playing of Videos, Photos, or Music, see:
 - Controlling Video Playback on page 41.
 - Controlling Music Playback on page 43.
 - Playing Photo Contents and Using the Tools Menu when a File is Highlighted on pages 44~47.

| NOTE |

- ▶ Depending on how and when you attach a content source to the product and the content type, the product may display a different series of screens to start playback. For alternative playback methods see:
 - Playing Files on a USB Storage Device or iPod/iPhone on page 37.
 - Playing Commercial Video Discs on page 38.
 - Playing Commercial Audio Discs on page 38.
 - Playing a Disc with User Recorded Content on page 39.



Playing Files on a USB Storage Device or iPod/iPhone

You can play multimedia files located on a connected USB device.

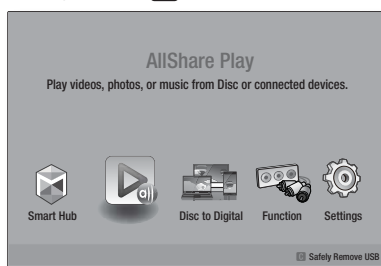
1. With the product turned off, connect a USB storage device or an iPod/iPhone.
2. Turn on the product. When the Main screen appears, select **AllShare Play > Videos, Photos or Music > Connected Device**, and then press the  button.









OR

- 1⁻¹. With the product turned on, connect a USB storage device or an iPod/iPhone.
- 2⁻¹. When screen below appears, use the   buttons to select the kind of content you want to view or play, and then press the  button.



| NOTE |

- ▶ Even though the product will display all available folders, it will only display files of the content type you selected in Step 2 or 2⁻¹. For example, if you selected music, you will only be able to see music files. You can change this selection using AllShare Play.

3. The kind of content you selected on the connected device is displayed. Depending on how the contents is arranged, you will see either folders, individual files, or both.
4. Using the    buttons on your remote, select the desired contents. To open a folder, select it, and then press the  button. To play a file, select it, and then press the  button.
5. Press the **RETURN** () button to exit a folder or to return to the Main screen.

| CAUTION |

- ▶ You can play a video only when you use the iPod Dock.

| NOTE |

- ▶ To prevent possible damage to the USB memory, you must remove the USB storage device safely using the "Safely Remove USB" function. Press the **HOME** button to move to the Home menu, select the **YELLOW (C)** button, and then press the  button.
- ▶ The **Photos** menu does not support iPods or iPhones.
- ▶ Only the playback screen will appear on the TV. View other iPod screens on the iPod player.
- ▶ If the connected iPod does not support video playback, the "Playing video files is not supported on this iPod model." message appears when you select the Video menu.

iPod/iPhone Models You Can Use with This Product

iPod touch 3rd/2nd/1st generation
 iPod classic / iPod with video
 iPod with dock connector
 iPod with Click Wheel
 iPod nano 5th/4th/3rd/2nd generation
 iPhone 4S / iPhone 4
 iPhone 3GS / iPhone 3G / iPhone

Media Play

The Function Screen



On the Function Screen, you can select the audio and/or video input source to view or listen to.

| NOTE |

- ▶ You can also change sources by pressing the Function button in the upper right of the remote.



To access the Function Screen, select the Function icon on the Main screen, and then press the  button.

Options on the Function Screen

To select, highlight an option using the   buttons, and then press the  button.

| | |
|-------------|---|
| Digital In | Select to listen to the digital audio source connected to Digital Audio In. |
| AUX | Select to listen to audio from the analog audio source connected to Audio In. |
| Remote iPod | Select to listen to music or view video from the iPod connected to the iPod jack. |
| HDMI IN 1 | Select to view video from the device connected to HDMI IN 1. |
| HDMI IN 2 | Select to view video from the device connected to HDMI IN 2. |
| Tuner | Select to listen to the FM radio. |



Playing Commercial Video Discs

1. Place a disc into the disc tray with the disc's label facing up and then close the disc tray. Playback starts automatically. If playback does not start automatically, press the  button on your remote or select the AllShare Play option on the Main screen, and then press the  button. See "Playing Video, Photo, or Music Content" on page 36.







Playing Commercial Audio Discs

1. Place a pre-recorded, commercial audio disc into the disc tray with the disc's label facing up, and then close the tray. The AllShare Play Music screen appears listing the tracks. Playback of the first track starts automatically.



2. To play a particular track, use the   buttons on the remote to select the track, and then press the  button.

□ Music Screen Controls

| | |
|---|---|
|  | Pause a track. |
|  | Play a track. |
|  | Repeat one track or all tracks. |
|  | Play tracks in random order. |
|  | Display the Equalizer. |
|  | Adjust the equalizer manually. (Only when equalizer mode is On) |

| NOTE |





- ▶ The Music Screen controls are only accessible when a track is playing.
- ▶ All controls do not appear at the same time.
- ▶ For more information about playing music, go to "Controlling Music Playback" on page 43.

Playing a Disc with User Recorded Content

You can play multimedia files you have recorded on DVD or CD discs.

1. Place a user recorded disc into the disc tray with the disc's label facing up, and then close the tray. The Device Connected pop-up appears.
2. Use the ▲▼ buttons to select the type of content you want to view or play - Videos, Photos, or Music - and then press the  button.

| NOTE |

- ▶ Even though the product will display folders for all content types, it will only display files of the content type you selected in Step 2. For example, if you selected music, you will only be able to see music files. You can change this selection using AllShare Play.
3. Use the ▲▼◀▶ buttons to select the folder containing the content type you selected in Step 2, and then press the  button.
 4. If you selected **Music**, the AllShare Play Music screen appears listing the music files on the disc. Use the ▲▼ buttons to select the file you want to play, and then press the  button.
 5. If you selected **Photos**, the AllShare Play Photos screen appears listing the photos on the disc. Use the ▲▼◀▶ buttons to select the photo you want to view, and then press the  button.
 6. If you selected **Videos**, the AllShare Play Videos screen appears listing the video files on the disc. Use the ▲▼◀▶ buttons to select the video you want to watch, and then press the  button.

| NOTE |

- ▶ For the Music and Video folders, you can also push the **TOOLS** button on your remote, and then select Play Folder to play or view all the files in the folder automatically. Select the folder first before pushing the **TOOLS** button.
- ▶ For more information about playing music, go to Controlling Music Playback on page 43.
- ▶ For more information about playing photo contents, go to Playing Photo Contents and Using the Tools Menu when a File is Highlighted on pages 44~47.
- ▶ For more information about playing video contents, go to Controlling Video Playback on page 41.

Using the AllShare Network Function

AllShare lets you play Videos, Photos, or Music located on your PC or your DLNA compatible device through the product using a wireless network connection.

To Download the AllShare Software

To use AllShare with your PC or DLNA device, you must install AllShare software on your PC.

You can download the PC software and get detailed instructions for using AllShare from the Samsung.com website.



1. Go to www.samsung.com.
2. Click Support at the top of the page.
3. On the Support page, enter the model number of your product into the Model Number field.
4. On the page that appears, click Get downloads on the left side under Downloads. The Download Center appears.
5. On the Download Center page, click the Software tab.
6. On the software tab, click the File icon on the right side of the AllShare line.
7. In the pop-up that appears, click Save File.
8. Find the AllShare install file on your disk, and then double click the file.
9. In the pop-up that appears, click Run, and then follow the directions that appear on your screen.

Download the AllShare Installation/Instruction manual from the same Software Tab by clicking the corresponding PDF file symbol in the File column on the right. The file, in PDF format, will download and open. You can view and/or save the file.

Media Play

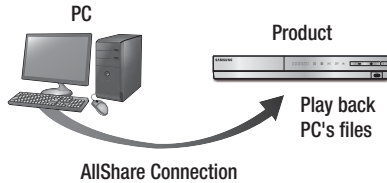
Playing Content Located on Your PC or DLNA Device through the Product



1. Connect the product, your PC, and/or your DLNA compatible cell phone to the same wireless network.
2. Follow the directions in the AllShare software Installation/Instruction manual to set up devices and files for playing or viewing.
3. Select **AllShare Play** in the product's Home screen, and then press the  button. The **AllShare Play** screen appears.
4. Select the connected DLNA compatible device or your PC, and then press the  button. A screen listing the available files appears.
5. Select the file you want to play or view, and then press the  button.

Controlling the Playback of Content Located on Your PC with Your Smart Phone

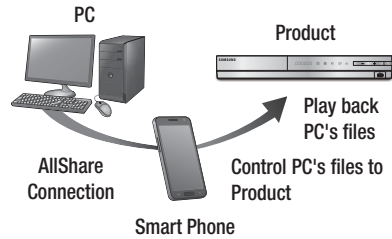

(Only available with Samsung phones supporting AllShare functionality.)

1. Connect the product, your PC, and your DLNA compatible cell phone to the same wireless network.
2. Follow the directions in the AllShare software Installation/Instruction manual to set up devices and files for playing or viewing.
3. On your computer, using the AllShare software, confirm your phone is connected.
4. On the phone, select the file you want to view or play, and then select the Blu-ray product as the playback device.
5. On the phone, start playback.

Controlling Video Playback

You can control the playback of video files located on Blu-ray, DVD, and CD discs, and on USB storage devices. Depending on the disc, some of the functions described in this manual may not be available.

Buttons on the Remote Control used for Video Playback

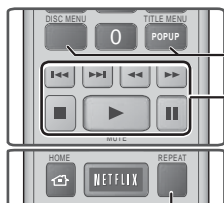

Using the disc menu, title menu, popup menu and title list

| | |
|--------------------------------|---|
| DISC MENU | During playback, press this button to display the Disc menu. |
| TITLE MENU | During playback, press this button to display the Title menu. <ul style="list-style-type: none"> If your disc has a playlist, press the GREEN (B) button to go to the playlist. |
| POPOP MENU | During playback, press this button to display the Pop-up menu. |
| DISC MENU or TITLE MENU | During playback, press this button to display the title list. |

Repeat Playback

| | |
|----------------------------------|--|
| Repeat a Title or Chapter | <ol style="list-style-type: none"> During playback, press the REPEAT button on the remote control. Press the ▲▼ buttons to select a Chapter, All or Title, then press the ☑ button. <p> NOTE </p> <ul style="list-style-type: none"> The screen may not display Chapter or Title immediately. Continue to press the ▲▼ buttons until your choice is inside the blue field. <ol style="list-style-type: none"> To return to normal play, press the REPEAT button again, press the ▲▼ buttons to select Off, and then press the ☑ button. |
| Repeat a Section | <ol style="list-style-type: none"> During playback, press the REPEAT button on the remote control. Press the ▲▼ buttons to select Repeat A-B. <p> NOTE </p> <ul style="list-style-type: none"> The screen may not display Repeat A-B immediately. Continue to press the ▲▼ buttons until Repeat A-B is inside the blue field. <ol style="list-style-type: none"> Press the ☑ button at the point where you want repeat play to start (A). Press the ☑ button at the point where you want repeat play to stop (B). To return to normal play, press the REPEAT button again. Press the ☑ button. <p> NOTE </p> <ul style="list-style-type: none"> You must set point (B) at least 5 seconds of playing time after point (A). |

Playback related buttons



The product does not play sound in Search, Slow, or Step mode.

| | |
|-------------------------|--|
| ▶ | Starts playback. |
| ◻ | Stops playback. |
| | Pauses playback. |
| Fast Motion Play | During playback, press the ◀▶ or ▶▶ button. Each time you press the ◀▶ or ▶▶ button, the playback speed will change. |
| Slow Motion Play | In pause mode, press the ▶▶ button. Each time you press the ▶▶ button, the playback speed will change. |
| Step Motion Play | In pause mode, press the button. Each time you press the button, a new frame appears. |
| Skip Motion Play | During playback, press the ◀▶ or ▶▶ button. Each time you press ◀▶ or ▶▶ button, the disc moves to the previous or next chapter or file. |

Media Play

Using the TOOLS Menu

During playback, press the **TOOLS** button.

| | |
|-------------------------------------|---|
| Title Search Time Search | Select to move to a desired title if the disc has more than one title, to a desired scene, or, using Time Search, to a specific point in a movie or video. With Time Search, you designate the specific point by entering a time coordinate in the following format 00:00:00 (hours, minutes, seconds) using the remote. |
| Repeat Mode | Select to repeat a specific Title, Chapter (BD/DVD discs only) or marked section. Works the same as the REPEAT button. See page 41. |
| Full Screen | Select to set the desired full screen size. You can select Original, Mode1 (larger), and Mode2 (largest). |
| Picture Mode | <p>Select to set the picture mode.</p> <ul style="list-style-type: none"> - Dynamic : Choose this setting to increase sharpness. - Standard : Choose this setting for most viewing applications. - Movie : This is the best setting for watching movies. - User : Lets you adjust the sharpness and noise reduction function respectively. <p> NOTE </p> <ul style="list-style-type: none"> ▶ When you select User, the User Settings screen appears. Select an option, press , use the ◀▶ buttons to make an adjustment, and then press . Press the RETURN () button to go back to the TOOLS menu. ▶ When you use the BD wise function, this menu will not appear. |
| Equalizer Mode | Select to use the Equalizer. |
| Equalizer Settings | <p>Select to set the Equalizer.</p> <p> NOTE </p> <ul style="list-style-type: none"> ▶ It only appears when equalizer mode is on. |

Menu that appears only when BD/DVD disc plays

| | |
|--|--|
| Play from the beginning | Select to play the movie from the beginning. |
| Chapter Search | Select to move to a chapter that you desire to watch. |
| Audio | <p>Select to set the desired audio language.</p> <ul style="list-style-type: none"> - You can also operate this function by pressing the AUDIO button on the remote control. |
| Subtitle | <p>Select to set the desired subtitle language.</p> <ul style="list-style-type: none"> - You can also operate this function by pressing the SUBTITLE button on the remote control. |
| Angle | To view a scene from another angle. The Angle option displays the number of angles available to view (1/1, 1/2, 1/3, etc.). |
| BONUSVIEW Video / BONUSVIEW Audio | Select to set the desired bonusview option. |

Menu that appears only when a file plays

| | |
|--------------------------|-------------------------------------|
| Go to Videos List | Move to video list screen. |
| Scene Search | Search the video file by the scene. |
| Information | Check the video file's information. |

| NOTE |

- ▶ Depending on the disc or storage device, the Tools menu may differ. All options may not be displayed.

Controlling Music Playback

You can control the playback of music content located on a DVD, CD, or a USB storage device.

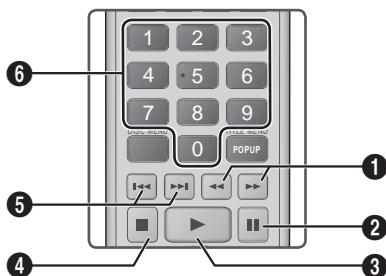

Buttons on the Remote Control used for Music Playback



| | |
|---|--|
| 1 | Fast Play (Audio CD (CD-DA) only) During playback, press the ◀◀ or ▶▶ button. Each time you press the ◀◀ or ▶▶ button, the playback speed will change. |
| 2 | ⏸ button : Pause a track. |
| 3 | ▶ button : Plays the currently selected track. |
| 4 | ◻ button : Stops a track. |
| 5 | Skip : During playback, press the ◀◀ or ▶▶ button to move to the previous or next music of listed. |
| 6 | NUMBER buttons : During Playlist playback, press the desired track number. The selected track is played. |



Repeating Tracks on an Audio CD

You can set the product to repeat tracks on an audio CD (CD-DA/MP3).

- During playback, use the ▶ button to select  in the lower right corner of the screen, and then press the  button.
- Use the ▲▼ to select the repeat mode you want - **Off**, **One Song**, or **All** - and then press the  button.





Shuffling Tracks on an Audio CD

You can set the product to play tracks on an audio CD (CD-DA/MP3) at random.

- During playback, use the ▶ button to select  in the lower right corner of the screen, and then press the  button.
- Use the ▲▼ to set the **Shuffle Mode On** or **Off**, and then press the  button.

Creating a Playlist



- With the Playback screen displayed, press the **TOOLS** button. The Tools menu appears.
- Use the ▲▼ buttons to select **Selection Play**, and then press the  button. The Selection Play screen appears.
- Use the ▲▼ buttons to select a track, and then press the  button. A check appears to the left of the track.
- Repeat Step 3 to select and check additional tracks.
- To remove a track from the list, move to the track, and then press the  button again. The check on the track is removed.
- When done, press the ▶ button to select **Play**, and then press the  button. The Music Playback screen reappears listing only the tracks you checked. The selected tracks play automatically.

| NOTE |

- ▶ You can create a playlist with up to 99 tracks on Audio CDs (CD-DA).
- ▶ If you have created a playlist, Selection Play is replaced by Edit Playlist on the Tools menu.
- ▶ On the Selection Play screen, you can also choose **Select All**, **Deselect All**, and **Cancel**.

Media Play

- Use **Select All** to select all tracks. This cancels your individual track selections. When you press the **RETURN (⏪)** button on your remote or select **PLAY** and then press the **⏪** button, all tracks will appear on the Music Playback screen, and the product will begin to play all tracks from Track 001.
- Use **Deselect All** to deselect all selected tracks at once. Then, select individual tracks or use **Select All** to select all the tracks, and then press the **RETURN (⏪)** button on your remote or select **PLAY** and then press the **⏪** button. If you do not use **Select All** or select individual tracks, the Playlist will not change.
- **Cancel** cancels any changes you made on the Play Select screen. When you return to the Playback screen, the Playlist will be unchanged.

Ripping

You can rip music from a music CD to a USB device inserted in the USB jack.

1. Insert a USB device into the USB jack on the front of the product, and then press the **RETURN (⏪)** button on your remote.
2. Insert the disc you want to rip from into the product and close the disc tray.
3. With the Playback screen displayed, press the **TOOLS** button. The Tools menu appears.
4. Use the **▲▼** buttons to select **Rip**, and then press the **⏪** button. The Rip screen appears.
5. Use the **▲▼** buttons to select a track, and then press the **⏪** button. A check appears to the left of the track.
6. Repeat Step 5 to select and check additional tracks.
7. To remove a track from the list, move to the track, and then press the **⏪** button again. The check on the track is removed.
8. When done, press the **▶** button to select **Rip**, and then press the **⏪** button. The Rip pop-up appears.
9. Press the **⏪** button to begin the ripping process. The Ripping Completion Bar pop-up appears.
10. When ripping is complete, the "**Ripping is completed.**" message appears. Press the **⏪** button.
11. Press the **RETURN (⏪)** button to go back to the Playback screen.

| NOTE |

- ▶ When Ripping is done, a folder called MP is created in the USB.

Playing Photo Contents

You can play photo contents located on a DVD, USB, mobile device or PC.

Using the Tools Menu

During playback, press the **TOOLS** button.

| | |
|---------------------------------|---|
| Go to Photos List | Select to go to the list of photos on the current media. |
| Start Slide Show | Select to start the slide show. |
| Slide Show Speed | Select to set a slide show's speed. |
| Slide Show Effect | Select to set a slide show's special effects. |
| Background Music On | Select to listen to music while viewing a slide show. |
| Background Music Setting | Select to set the background music setting. |
| Picture Mode | Select to set the picture settings. <ul style="list-style-type: none"> - Dynamic : Choose to increase Sharpness. - Standard : Choose for most viewing applications. - Movie : This is the best setting for watching movies. - User : Lets you adjust the sharpness and noise reduction function respectively. NOTE <ul style="list-style-type: none"> ▶ When you use the BD wise function, this menu will not appear. |
| Zoom | Select to enlarge the current picture. (Enlarge up to 4 times) |
| Rotate | Select to rotate the picture. (This will rotate the picture either clockwise or counter clockwise.) |
| Information | Shows the picture information. |













| NOTE |

- ▶ Depending on the disc or storage device, the Tools menu may differ. All options may not be displayed.
- ▶ To enable the background music function, the photo file must be in the same storage media as the music file. However, the sound quality can be affected by the bitrate of the MP3 file, the size of the photo, and the encoding method.
- ▶ You can't enlarge the subtitle and PG graphic in the full screen mode.























Using the Tools Menu when a File is Highlighted

When a file is highlighted, press the **TOOLS** button.

| | |
|--------------------|---|
| View | Select to access the sort options: Artist, Genre, Monthly, Latest Date, etc. The sort options that appear depend on the storage and media type. |
| Folder view | Appears in the View function screen. Select to display the folders on the storage device. |
| Title | Appears on the View function screen. Select to sort all photo or video files on a storage device by title. |
| Artist | Appears on the View function screen. Select Artist to sort and then display all music tracks on a storage device by artist. |
| Album | Appears on the View function screen. Select Album to sort and then display all music tracks on a storage device by album. |
| Genre | Appears on the View function screen. Select Genre to sort and then display all music tracks on a storage device by genre. |
| Latest Date | Appears on the View function screen. Select to sort and then display all photo or video files on a storage device from the latest to earliest date. |

| | |
|-----------------------|--|
| Earliest Date | Appears on the View function screen. Select to sort and then display all photo or video files on a storage device from the earliest to latest date. |
| Monthly | Appears on the View function screen. Select to sort all photo or video files on a storage device by the month created. |
| Selection Play | <p>Selection Play lets you select specific music, video, and photo files to play. It works essentially the same for all media. The example below is for photos.</p> <ol style="list-style-type: none"> 1. On the Thumbnail View screen, highlight a photo, and then press the TOOLS button on the remote. 2. In the Tools menu, select Selection Play, and then press the  button. 3. On the selection screen, use the     buttons to select a photo you want to view, and then press the  button. A check mark appears to the left of the picture. 4. Repeat Step 3 for each photo you want to view. 5. To de-select a photo, highlight it, and then press the  button. 6. When done, use the   buttons to select Play, and then press the  button. A slide show containing the photos you selected begins. 7. To pause the slide show, press the  button once. To restart the slide show, press the  button again. 8. To stop the slide show, press the RETURN () button. <p> NOTE </p> <ul style="list-style-type: none"> ▶ After the slide show begins, you can control the slide show by pressing the TOOLS button and displaying the Slide Show menu. See "Using the Tools Menu" page 44. |

Media Play

| | | |
|-------------------------------|---|---|
| <p>Send</p> | <p>Select Send to upload selected files to Picasa, Facebook, Cloud Storage, N Drive, or Family Story.</p> <p>To use Send, you need to establish an account with the on-line site, and then log in using the Log In function.</p> <ol style="list-style-type: none"> 1. Use the ▲▼◀▶ buttons to select a file, and then press the  button. 2. Repeat for each track or file you want to upload. <p> NOTE </p> <ul style="list-style-type: none"> ▶ You can also move to Select All on the right, and then press the  button to select all tracks or files. <ol style="list-style-type: none"> 3. Select Send on the right side, and then press the  button. 4. Use the ▲▼ buttons to select the on line site you want to upload the files or tracks to, and then press the  button. | <ul style="list-style-type: none"> • Select Create New, and then press the  button. On the keyboard pop-up that appears, create a name for the new playlist. Enter numbers using the numbers on the remote. Enter letters by using the ▲▼◀▶ buttons to move the cursor, and then pressing the  button. When finished, move to DONE at the bottom of the screen, and then press the  button. |
| <p>Login / Out</p> | <p>The Log In/Out function lets you log in to your online Samsung account.</p> | <p>Delete (Playlist)</p> <p>Depending on the screen you are viewing, select Delete to erase a file from erasable media (such as a USB device) or to delete a playlist.</p> |
| <p>Add to Playlist</p> | <p>Select to create a playlist or add files or tracks to a playlist.</p> <ol style="list-style-type: none"> 1. Select Add to Playlist, and then press the  button. 2. Use the ▲▼◀▶ buttons to highlight a track or file, and then press the  button. 3. Repeat for each track or file you want to add. 4. Select Add on the right, and then press the  button. 5. On the screen that appears, perform one of the following actions: <ul style="list-style-type: none"> • Select the Playlist to which you want to add the tracks or files and then press  button. | <p>Edit Playlist</p> <p>Select Edit Playlist to remove files or tracks from an existing playlist. The storage device containing the playlist must be inserted into or attached to the product.</p> <ol style="list-style-type: none"> 1. Use the ▲▼◀▶ buttons to select a file, and then press the  button. 2. Repeat for each track or file you want to remove. <p> NOTE </p> <ul style="list-style-type: none"> ▶ You can also move to Select All on the right, and then press the  button to select all tracks or files. <ol style="list-style-type: none"> 3. Select Remove on the right side, and then press the  button. |
| <p>Add to Playlist</p> | <p>Select to create a playlist or add files or tracks to a playlist.</p> <ol style="list-style-type: none"> 1. Select Add to Playlist, and then press the  button. 2. Use the ▲▼◀▶ buttons to highlight a track or file, and then press the  button. 3. Repeat for each track or file you want to add. 4. Select Add on the right, and then press the  button. 5. On the screen that appears, perform one of the following actions: <ul style="list-style-type: none"> • Select the Playlist to which you want to add the tracks or files and then press  button. | <p>Play Current Group</p> <p>After you have sorted by Artist, Genre, Album, Title, Latest Date, Earliest Date, or Monthly, select a group that is the result of the sort (for example, all pictures taken in August), and then select Play Current Group to play or view the files in that group only.</p> |
| <p>Add to Playlist</p> | <p>Select to create a playlist or add files or tracks to a playlist.</p> <ol style="list-style-type: none"> 1. Select Add to Playlist, and then press the  button. 2. Use the ▲▼◀▶ buttons to highlight a track or file, and then press the  button. 3. Repeat for each track or file you want to add. 4. Select Add on the right, and then press the  button. 5. On the screen that appears, perform one of the following actions: <ul style="list-style-type: none"> • Select the Playlist to which you want to add the tracks or files and then press  button. | <p>Go to Playlist</p> <p>Select to go to the Playlist section of the Main AllShare screen.</p> |



| | |
|--------------------|---|
| Encoding | Encoding - which changes by language or by geographical area - modifies how the product sorts, arranges, and presents files or tracks, displays dates, etc. Select Encoding to change the encoding to match your language or geographical area. |
| Information | Displays media file and content information. |

| NOTE |

- ▶ Depending on the disc or storage device, the Tools menu may differ. All options may not be displayed.

Listening to Radio

Using Buttons on the Remote Control

1. Press the **FUNCTION** button to select **FM**.
2. Tune in to the desired station.
 - Preset Tuning 1 : Press the  button to select **PRESET** and then press the **TUNING/CH** ($\wedge \vee$) button to select the preset station.
 - Before you can tune to preset stations, you must add preset stations to the product's memory.
 - Manual Tuning : Press the  button to select **MANUAL** and then press the **TUNING/CH** ($\wedge \vee$) button to tune in to a lower or higher frequency.
 - Automatic Tuning : Press the  button to select **MANUAL** and then press and hold the **TUNING/CH** ($\wedge \vee$) button to automatically search the band.

Setting Mono/Stereo

Press the **MO/ST** button.

- Each time the button is pressed, the sound switches between **STEREO** and **MONO**.
- In a poor reception area, select **MONO** for a clear, interference-free broadcast.

Presetting Stations

Example : Presetting FM 89.10 into memory.

1. Press the **FUNCTION** button to select **FM**.
2. Press the **TUNING/CH** ($\wedge \vee$) button to select <89.10>.
3. Press the **TUNER MEMORY** button.
 - NUMBER flashes on the display.
4. Press the **TUNER MEMORY** button again.
 - Press the **TUNER MEMORY** button before NUMBER disappears from the display on its own.
 - After you press the **TUNER MEMORY** button, NUMBER disappears from the display and the station is stored in memory.
5. To preset another station, repeat steps 2 to 4.
 - To tune in to a preset station, press the **TUNING/CH** ($\wedge \vee$) button.

Using the Special Effects Remote Control Buttons

| | |
|------------------------------|---|
| SOUND EFFECT Function |  |
|------------------------------|---|

Lets you select a mode that optimizes the sound.

1. Press the **SOUND EFFECT** button.
2. Press the $\blacktriangle \blacktriangledown$ button to select the desired mode: **DSP**, **Dolby Pro Logic II** or **SFE Mode**.
3. Press the $\blacktriangleleft \blacktriangleright$ buttons to select the desired sound effect.

DSP

MP3 Enhancer → **Power Bass** → **Virtual 7.1** → **Off**

- **MP3 Enhancer** : Helps enhance your sound experience (ex. mp3 music). You can upscale your MP3 level sound (24 kHz, 8bit) to CD level sound (44.1 kHz, 16bit).
- **Power Bass** : Increases the volume level of bass tones and provides thudding sound effects.
- **Virtual 7.1** : Applies the 7.1 CH sound effect using the 5.1 CH speaker system.
- **Off** : Select this for normal listening.

Media Play

□ Dolby Pro Logic II

Movie → Music → Game → Matrix → Prologic → Off

- **Movie** : Adds realism to a movie soundtrack.
- **Music** : When listening to music, you can experience sound effects as if you are listening to the actual performance.
- **Game** : Enhances the excitement of the game's sound.
- **Matrix** : Select to hear multi channel surround sound.
- **Prologic** : Select to listen to a 2CH sound source in 5.1CH surround sound with all speakers active.
- A specific speaker(s) may not output depending on the input signal.
- **Off** : Select this for normal listening.

□ SFE Mode

Symphony Hall in Boston (Hall 1) → Philharmonic Hall in Bratislava (Hall 2) → Jazz Club in Seoul B → Church in Seoul → Amphitheater (Rock) → Off

- **Symphony Hall in Boston (Hall 1)** : Provides a clear vocal as if listening in a concert hall.
- **Philharmonic Hall in Bratislava (Hall 2)** : Also provides a clear vocal as if listening in a concert hall but, less powerful than HALL1.
- **Jazz Club in Seoul B** : Recommended setting for Jazz.
- **Church in Seoul** : Gives the feel of being in a grand church.
- **Amphitheater (Rock)** : Recommended setting for Rock.
- **Off** : Select this for normal listening.



You can enjoy more natural and vivid surround sound with enriched tones by adjusting the depth of sound using the level options.

Off → High → Medium → Low

| NOTE |

- ▶ It is not available in **FM** mode.

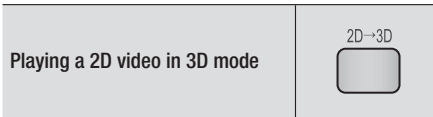

You can enjoy an ordinary 2D video in 3D mode.

| NOTE |

- ▶ If you move to the Home or Smart Hub Home menu in 3D mode, it will switch to 2D automatically.

Network Services

You can enjoy various network services such as Smart Hub or BD-LIVE by connecting the product to your network.

To use network services, you must first:

1. Connect the product to the network.
(See page 21)
2. Configure the network settings.
(See pages 30–33)

Using Smart Hub

Using Smart Hub, you can download movies, videos, and music from the Internet, and access various for pay or free-of-charge applications and view them on your TV. Application content includes news, sports, weather forecasts, stock market quotes, maps, photos, and games.

For instructions that explain how to use Smart Hub, follow these steps:

1. Go to www.samsung.com.
2. Click Support at the top of the page.
3. On the Support page, enter the model number of your product into the Model Number field.
4. On the page that appears, click Get downloads on the left side under Downloads. The Download Center appears.
5. On the Download Center page, click the Manuals tab.
6. On the Manuals tab, click the file icon to the right of Smart Hub Users Manual. The manual downloads.

| NOTE |

- ▶ The web location of the Smart Hub manual is subject to change without notice.

Smart Hub at a Glance

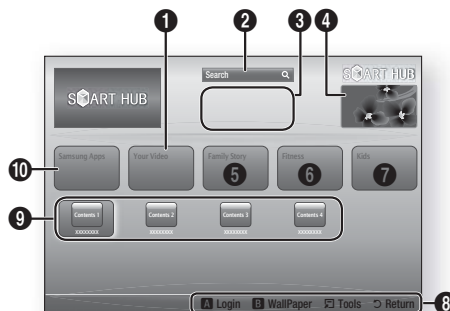

- | | |
|---|--|
| 1 | Your Video : Provides recommendations for videos based on your tastes. |
| 2 | Search : Provides an integrated search of your video providers and connected AllShare devices. |
| 3 | Recommended : Displays recommended contents managed by Samsung. |
| 4 | Commercial : Displays the Smart Hub Guide, an introduction to the product, and new application introductions. |
| 5 | Family Story : An effortless way to access family content. <ul style="list-style-type: none"> • Provides access to family photos, messages, and events, anytime and anywhere. |
| 6 | Fitness : Gateway to the Unified Self-Care Service. <ul style="list-style-type: none"> • Presents fitness videos from various content partners with feedback on calories burned after every workout. |
| 7 | Kids : Kids service gives kids an easy and safe way to enjoy their favorite content. <ul style="list-style-type: none"> • Provides a wide variety of fun and safe content for children. |
| 8 | Navigation Help : Displays the remote control buttons you can use to navigate in Smart Hub. <ul style="list-style-type: none"> • RED (A) : To log in to Smart Hub. • GREEN (B) : To display the background screen. • Tools : To display the settings window. • Return : To return to the previous menu. |

Network Services

| | |
|----|---|
| 9 | My Applications : Displays your personal gallery of applications which you can add to, modify, and delete. |
| 10 | Samsung Apps : Open Samsung Apps to download various for pay or free-of-charge application services. |

Using the Web Browser

You can access the internet using the Web Browser application which is installed in the Smart Hub screen by default.

1. Select **Smart Hub** on the Home screen, and then press the  button.
2. Select the Web Browser application in Smart Hub, and then press the  button.







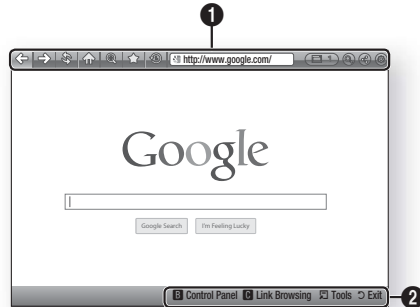





| NOTE |

- ▶ When you run the Web Browser with the product connected by HDMI to a BD Wise compatible TV - and BD Wise is on - the browser is maximized to fill the screen and the TV's resolution is set to the optimal resolution automatically.
- ▶ The Web Browser is not compatible with Java applications.
- ▶ If you attempt to download a file, and the file can not be saved, an error message will appear.
- ▶ The playback of Flash videos is not supported.
- ▶ E-commerce, for purchasing products online, is not supported.
- ▶ ActiveX is not supported.

Web Browser at a Glance



Control Panel : Displays the various Web Browser functions.







-  : Moves to the previous page.
-  : Moves to the last page before going back.
-  : Reloads the current page so that it is refreshed on the screen.
-  : Moves to the Home screen of the Web Browser.
-  : Allows you to zoom in or out of the screen at various percentages.
-  : Allows you to bookmark specific pages so that you can move to them easily.
-  : Allows you to view the history of your visited pages by date, name, or frequency.
-  : Allows you to enter a page address manually or select a page from the visited page list to move to that page.
-  : Allows you to switch easily between multiple, currently open Web Browser windows.
-  : Allows you to search for information by entering words.
-  : Lets you share the current site with your family group by sending a message.
-  : Allows you to configure all settings for using the Web Browser.

Navigation Help : Displays the remote control buttons you can use to navigate in Web Browser.

- 2 • **GREEN (B)** : To display the Control Panel.
- **YELLOW (C)** : You can change the cursor to Link Browsing mode or Pointer Browsing mode.
- **Tools** : To display Tools window.
- **Exit** : To return to the previous menu.

BD-LIVE™

Once the product is connected to your network, you can enjoy various movie-related service contents available on BD-LIVE compliant discs.

- 1 . Attach a USB memory stick to the USB jack on the front of the product, and then check its remaining memory. The memory device must have at least 1GB of free space to accommodate the BD-LIVE services.
- 2 . Select **Settings** on the Home screen, and then press the  button.
- 3 . Select **Network**, and then press the  button.
- 4 . Select **BD-Live Settings**, and then press the  button.
- 5 . Select **BD Data Management**, and then press the  button.
- 6 . Select **Select Device**, and then press the  button.
- 7 . Select **USB**, and then press the  button.
- 8 . Insert a Blu-ray Disc that supports BD-LIVE.
- 9 . Select an item from the list of BD-LIVE service contents provided by the disc manufacturer.

| NOTE |

- ▶ The way you use BD-LIVE and the provided contents may differ, depending on the disc manufacturer.

Using Disc to Digital

Access your movie collection via cloud storage anytime, any place without your DVD disc. Go to www.samsungsupport.com for more detailed information.

| NOTE |

- ▶ You can access the Disc to Digital function by pressing the **Disc2Digital** button on your remote control.
- ▶ Samsung may add additional applications for this feature in the future.



Additional Information

Note

| | |
|---|--|
| Connections | HDMI OUT |
| | <ul style="list-style-type: none"> • Certain HDMI output resolutions may not work, depending on your TV. • You must have an HDMI connection to enjoy videos with 3D technology. • A long HDMI cable may cause screen noise. If this occurs, set HDMI Deep Color to Off in the menu. |
| Settings | 3D Settings |
| | <ul style="list-style-type: none"> • For some 3D discs, to stop a movie during 3D playback, press the [] button once. The movie stops and the 3D mode option is de-activated. • To change a 3D option selection when you are playing a 3D movie, press the [] button once. The Blu-ray menu appears. Press the [] button again, then select 3D Settings in the Blu-ray menu. • Depending on the content and the position of the picture on your TV screen, you may see vertical black bars on the left side, right side, or both sides. |
| | TV Aspect |
| | <ul style="list-style-type: none"> • Depending on the disc type, some aspect ratios may not be available. • If you select an aspect ratio and option which is different than the aspect ratio of your TV screen, then the picture might appear to be distorted. • If you select the 16:9 Original, your TV may display 4:3 Pillarbox (black bars on sides of picture). |
| | BD Wise (Samsung Products only) |
| | <ul style="list-style-type: none"> • When BD Wise is on, the Resolution setting automatically defaults to BD Wise and BD Wise appears in the Resolution menu. • If the product is connected to a device that does not support BD Wise, you can not use the BD Wise function. • For proper operation of BD Wise, set the BD Wise option in both the product and the TV to On. |
| | Digital Output |
| <ul style="list-style-type: none"> • Be sure to select the correct Digital Output or you will hear no sound or just loud noise. • If the HDMI device (AV receiver, TV) is not compatible with compressed formats (Dolby digital, DTS), the audio signal outputs as PCM. • Regular DVDs do not have BONUSVIEW audio and Navigation Sound Effects. • Some Blu-ray Discs do not have BONUSVIEW audio and Navigation Sound Effects. • This Digital Output setup does not affect the analog (L/R) audio or HDMI audio output to your TV. It affects the optical and HDMI audio output when your product is connected to an AV receiver. • If you play MPEG audio soundtracks, the audio signal outputs as PCM regardless of your Digital Output selections (PCM or Bitstream). | |
| BD-LIVE Internet Connection | |
| <ul style="list-style-type: none"> • The Internet connection may be restricted while you are using BD-LIVE contents. | |

| | |
|---|--|
| Settings | Anynet+ (HDMI-CEC) |
| | <ul style="list-style-type: none"> Depending on your TV, certain HDMI output resolutions may not work. Please refer to the user manual of your TV. This function is not available if the HDMI cable does not support CEC. If your Samsung TV has an Anynet+ logo, then it supports the Anynet+ function. |
| | BD Data Management |
| | <ul style="list-style-type: none"> In the external memory mode, disc playback may be stopped if you disconnect the USB device in the middle of playback. Only those USB devices formatted in the FAT file system (DOS 8.3 volume label) are supported. We recommend you use USB devices that support USB 2.0 protocol with 4 MB/sec or faster read/write speed. The Resume Play function may not work after you format the storage device. The total memory available to BD Data Management may differ, depending on the conditions. |
| | Front Display |
| | <ul style="list-style-type: none"> You cannot change the brightness of the  button and the VOL +, - button. |
| | Speaker Settings |
| | <ul style="list-style-type: none"> When Speaker Selection is selected to TV Speaker, audio is produced through TV speakers. |
| | HDMI audio |
| | <ul style="list-style-type: none"> When HDMI audio output to the TV speaker, it is automatically down-mixed to 2 channels. |
| Audio Return Channel | |
| <ul style="list-style-type: none"> When Anynet+ (HDMI-CEC) is Off, the Audio Return Channel function is not available. Using an HDMI cable not certified for ARC (Audio Return Channel) may cause a compatibility problem. The ARC function is only available if an ARC-compliant TV is connected. | |
| Digital Output | |
| <ul style="list-style-type: none"> Digital Output can be activated when Speaker Selection is selected to TV Speaker. | |
| Playback | Playing a Video files |
| | <ul style="list-style-type: none"> Video files with high bitrates of 20Mbps or more strain the product's capabilities and may stop playing during playback. |
| Selecting the Audio Language | |
| <ul style="list-style-type: none"> The ◀▶ indicator will not appear on the screen if the BONUSVIEW section does not contain any BONUSVIEW audio settings. The languages available through the Audio Language function depend on the languages that are encoded on the disc. This function or certain languages may not be available. Some Blu-ray Discs may allow you to select either the PCM or Dolby digital audio soundtrack in English. | |

Appendix

| | |
|---------------|---|
| Playback | Selecting the Subtitle Language <ul style="list-style-type: none"> Depending on the Blu-ray Disc / DVD, you may be able to change the subtitle language in the Disc Menu. Press the DISC MENU button. This function depends on the selection of subtitles that are encoded on the disc and may not be available on all Blu-ray Discs/DVDs. Information about the main feature BONUSVIEW mode will also appear if the Blu-ray Disc has a BONUSVIEW section. This function changes both the primary and secondary subtitles at the same time. The total number of primary and secondary subtitles are displayed respectively. |
| | Playing a JPEG files <ul style="list-style-type: none"> You can't enlarge the subtitle and PG graphic in the full screen mode. |
| | Dolby Pro Logic II Mode <ul style="list-style-type: none"> Before selecting Dolby Pro Logic II mode, connect your external device to the AUDIO INPUT jacks (L and R) on the product. If you connect to only one of the inputs (L or R), you cannot listen to surround sound. |
| AllShare Play | Using the TOOLS button while playing pictures <ul style="list-style-type: none"> If the system is connected to a BD Wise compliant TV that has set BD Wise to On, the Picture Settings menu will not appear. The Background Music function will not work unless the music file and the photo file are located on the same storage media. Also, sound quality can be impacted by the bitrate of the MP3 music file, the size of the photos, and the encoding method. |
| | Playing back a USB Storage Device <ul style="list-style-type: none"> You must remove the USB storage device safely (by performing the "Safely Remove USB" function) to prevent possible damage to the USB memory. Press the HOME button to move to the Home menu, select the YELLOW (C) button, and then press the  button. |
| | Playing Music <ul style="list-style-type: none"> Adjust the volume to a moderate level before you connect your iPod to the product. When the product is on and you connect an iPod, the product will charge the iPod's battery. |
| | Watching a Movie <ul style="list-style-type: none"> You must have the VIDEO output (Composite) connected to your TV to view iPod video (See page 19). If you want to play iPod video via VIDEO output, set Anynet+ (HDMI-CEC) to off. Only the playback screen will appear on the TV. View other iPod screens on the iPod player. If you want to return to the iPod menus while the iPod player is connected using the dock, press FUNCTION on the remote control or press  on the front panel of the system and select R. IPOD. The Function mode switches as follows : BD/DVD → D. IN → AUX → R. IPOD → HDMI1 → HDMI2 → FM |
| | |
| | |
| | |

| | |
|-------------|--|
| iPod | iPod/iPhone Models You Can Use with This Product |
| | <ul style="list-style-type: none">• The volume control may not operate normally with iPod and iPhone models not listed on page 37. If you have a problem with any of the models listed above, please update the software of the iPod/iPhone to the latest version.• Depending on the software version of the iPod, control problems may occur. This is not a malfunction of the Home Theater.• Depending on the software version or the type of iPod, some operations may differ. Install the latest iPod software. (recommended)• You can enjoy music or videos through the Blu-ray/DVD disc function and enjoy music, videos through the Remote iPod function. You need to use the iPod Dock to enjoy videos.• Playback of applications' contents through the product is not guaranteed. We recommend playing contents downloaded to the iPod.• If you have a problem using your iPod, please visit www.apple.com/support/ipod. |

Appendix

Resolution according to the output mode

□ Blu-ray Disc/E-contents/Digital Contents playback

| Setup \ Output | HDMI/connected | | | HDMI/not connected |
|---------------------------|-----------------------------|---------------------------------|------------|--------------------|
| | HDMI Mode | | VIDEO Mode | VIDEO Mode |
| | Blu-ray Disc | E-contents/ Digital contents | | |
| BD Wise | Resolution of Blu-ray Disc | 1080p@60F | 480i | - |
| Auto | Max. Resolution of TV input | Max. Resolution of TV input | 480i | - |
| 1080p@60F | 1080p@60F | 1080p@60F | 480i | - |
| Movie Frame : Auto (24Fs) | 1080p@24F | 1080p@24F | 480i | - |
| 1080i | 1080i | 1080i | 480i | 480i |
| 720p | 720p | 720p | 480i | 480i |
| 480p | 480p | 480p | 480i | 480i |
| 480i | - | - | - | 480i |

□ DVD playback

| Setup \ Output | HDMI/connected | | HDMI/not connected |
|----------------|-----------------------------|------------|--------------------|
| | HDMI Mode | VIDEO Mode | VIDEO Mode |
| BD Wise | 480i | 480i | - |
| Auto | Max. Resolution of TV input | 480i | - |
| 1080p@60F | 1080p@60F | 480i | - |
| 1080i | 1080i | 480i | 480i |
| 720p | 720p | 480i | 480i |
| 480p | 480p | 480i | 480i |
| 480i | - | - | 480i |

Digital Output Selection

| Setup | PCM | Bitstream (Unprocessed) | Bitstream (Re-encoded DTS) | Bitstream (Re-encoded Dolby D) | |
|------------------------------|------------------------------|--|--|--|---|
| Connection | HDMI supported AV receiver | | | | |
| Audio Stream on Blu-ray Disc | PCM | Up to PCM 7.1ch | PCM | DTS re-encoded | Re-encoded Dolby Digital * |
| | Dolby Digital | Up to PCM 7.1ch | Dolby Digital | DTS re-encoded | Re-encoded Dolby Digital * |
| | Dolby Digital Plus | Up to PCM 7.1ch | Dolby Digital Plus | DTS re-encoded | Re-encoded Dolby Digital * |
| | Dolby TrueHD | Up to PCM 7.1ch | Dolby TrueHD | DTS re-encoded | Re-encoded Dolby Digital * |
| | DTS | Up to PCM 6.1ch | DTS | DTS re-encoded | Re-encoded Dolby Digital * |
| | DTS-HD High Resolution Audio | Up to PCM 7.1ch | DTS-HD High Resolution Audio | DTS re-encoded | Re-encoded Dolby Digital * |
| | DTS-HD Master Audio | Up to PCM 7.1ch | DTS-HD Master Audio | DTS re-encoded | Re-encoded Dolby Digital * |
| Audio Stream on DVD | PCM | PCM 2ch | PCM 2ch | PCM 2ch | PCM 2ch |
| | Dolby Digital | Up to PCM 5.1ch | Dolby Digital | Dolby Digital | Dolby Digital |
| | DTS | Up to PCM 6.1ch | DTS | DTS | DTS |
| Definition for Blu-ray Disc | Any | Decodes the main feature audio and BONUSVIEW audio stream together into PCM audio and adds Navigation Sound Effects. | Outputs only the main feature audio stream so that your AV receiver can decode the audio bitstream. You will not hear BONUSVIEW audio or Navigation Sound Effects. | Decodes the main feature audio and BONUSVIEW audio stream together into PCM audio and adds Navigation Sound Effects, then re-encodes the PCM audio into DTS bitstream. | Decodes the main feature audio and BONUSVIEW audio stream together into PCM audio and adds Navigation Sound Effects, then re-encodes the PCM audio into Dolby digital bitstream or PCM. |

* If the Source Stream is 2ch or mono, "Re-encoded Dolby D" Setting are not applied. Output will be PCM 2ch.

Blu-ray Discs may include three audio streams :





- Main Feature Audio : The audio soundtrack of the main feature.
- BONUSVIEW audio : An additional soundtrack such as the director or actor's commentary.
- Navigation Sound Effects : When you choose some menu navigation, Navigation Sound Effects may sound. Navigation Sound Effects are different on each Blu-ray Disc.

Appendix

Troubleshooting

Refer to the table below when this product does not function properly. If the problem you are experiencing is not listed below or if the instructions below do not help, turn off the product, disconnect the power cord, and contact Samsung Electronics at 1-800-SAMSUNG (1-800-726-7864).

| Symptom | Check/Remedy |
|---|--|
| I cannot eject the disc. | <ul style="list-style-type: none"> Is the power cord plugged securely into the outlet? Turn off the power and then turn it back on. |
| The iPod fails to connect. | <ul style="list-style-type: none"> Check the condition of the iPod connector and Dock. Keep the iPod software version up to date. |
| Playback does not start. | <ul style="list-style-type: none"> Check the region number of the Blu-ray/DVD disc. Blu-ray/DVD disc purchased from abroad may not be playable. CD-ROMs and DVD-ROMs cannot be played on this product. Make sure that the rating level is correct. |
| Playback does not start immediately when the Play/Pause button is pressed. | <ul style="list-style-type: none"> Are you using a deformed disc or a disc with scratches on the surface? Wipe the disc clean. |
| Sound is not produced. | <ul style="list-style-type: none"> The home theater does not play sound during fast playback, slow playback, and step motion playback. Are the speakers connected properly? Is the speaker setup correctly customized? Is the disc severely damaged? |
| Sound can be heard only from a few speakers and not all 6. | <ul style="list-style-type: none"> On certain Blu-ray/DVD discs, sound is output from the front speakers only. Check if the speakers are connected properly. Adjust the volume. When listening to a CD, radio or TV, sound is output to the front speakers only. |
| Dolby Digital 5.1 CH Surround Sound is not produced. | <ul style="list-style-type: none"> Is there "Dolby Digital 5.1 CH" mark on the disc? Dolby Digital 5.1 CH Surround Sound is produced only if the disc is recorded with 5.1 channel sound. Is the audio language correctly set to Dolby Digital 5.1-CH in the information display? |
| The remote control does not work. | <ul style="list-style-type: none"> Are you operating the remote within its operational range and within the proper angle relative to the sensor? Are the batteries drained? Have you selected the mode (TV/BD) functions of the remote control (TV or BD) correctly? |
| <ul style="list-style-type: none"> The disc is rotating but no picture is produced. Picture quality is poor and picture is shaking. | <ul style="list-style-type: none"> Is the TV power on? Are the video cables connected properly? Is the disc dirty or damaged? A poorly manufactured disc may not be playable. |
| Audio language and subtitles do not work. | <ul style="list-style-type: none"> Audio language and subtitles will not work if the disc does not contain them. |

| Symptom | Check/Remedy |
|--|--|
| The menu screen does not appear even when the menu function is selected. | <ul style="list-style-type: none"> Are you using a disc that does not contain menus? |
| The aspect ratio cannot be changed. | <ul style="list-style-type: none"> You can play 16:9 Blu-ray/DVD discs in 16:9 Full mode, 4:3 Letter Box mode, or 4:3 Pan-Scan mode, but 4:3 Blu-ray/DVD discs are played in 4:3 ratio only. Refer to the Blu-ray Disc jacket and then select the appropriate function. |
| <ul style="list-style-type: none"> The product is not working. (Example: The power goes out or a strange noise is heard.) The Product is not working normally. | <ul style="list-style-type: none"> Press and hold the remote control's  button for 5 seconds in STANDBY mode. <ul style="list-style-type: none"> Using the RESET function will erase all stored settings. Do not use this unless necessary. |
| You have forgotten the rating level password. | <ul style="list-style-type: none"> With no disc in the product, press and hold the product's  button for longer than 5 seconds. INIT appears on the display and all settings will return to the default values. Then, press the POWER button. <ul style="list-style-type: none"> Using the RESET function will erase all stored settings. Do not use this unless necessary. |
| Can't receive radio broadcasts. | <ul style="list-style-type: none"> Is the antenna connected properly? If the antenna's input signal is weak, install an external FM antenna in an area with good reception. |
| While listening to TV audio through the Product, no sound is heard. | <ul style="list-style-type: none"> If the OPEN/CLOSE  button is pressed while listening to TV audio using the D. IN or AUX functions, the Blu-ray/DVD disc functions are turned on and the TV audio is muted. |
| "Not Available" appears on screen. | <ul style="list-style-type: none"> The features or action cannot be completed at this time because: <ol style="list-style-type: none"> The Blu-ray/DVD disc's software restricts it. The Blu-ray/DVD disc's software doesn't support the feature (e.g., angles) The feature is not available at the moment. You've requested a title or chapter number or search time that is out of range. |
| If the HDMI output is set to a resolution your TV cannot support (for example, 1080p), you may not see a picture on your TV. | <ul style="list-style-type: none"> Press and hold the  button on front panel for more than 5 seconds with no disc inserted. All settings will revert to the factory settings. |
| No HDMI output. | <ul style="list-style-type: none"> Check the connection between the TV and the HDMI jack of the product. Check if your TV supports 480p/720p/1080i/1080p HDMI input resolution. |
| Abnormal HDMI output screen. | <ul style="list-style-type: none"> If random noise appears on the screen, it means that TV does not support HDCP (High-bandwidth Digital Content Protection). |

Appendix

| Symptom | Check/Remedy |
|--|---|
| AllShare Play function | |
| I can see folders shared through AllShare Play, but I cannot see the files. | <ul style="list-style-type: none"> AllShare Play shows only files corresponding to the Photo, Music, and Movie categories. Files that do not correspond to these categories may not be displayed. |
| Video is played intermittently. | <ul style="list-style-type: none"> Check if the network is stable. Check if the network cable is properly connected and if the network is not overloaded. The wireless connection between the server and the product is unstable. Check the connection. |
| The AllShare Play connection between the TV and PC is unstable. | <ul style="list-style-type: none"> IP address under the same subnetwork should be unique, otherwise IP collision can result in such a phenomenon. Check if you have a firewall enabled. If so, disable the firewall function. |
| BD-LIVE | |
| I cannot connect to the BD-LIVE server. | <ul style="list-style-type: none"> Test whether the network connection is successful by using the Network Status function. Check whether a USB memory device is connected to the product. The memory device must have at least 1GB of free space to accommodate the BD-LIVE service. You can check the available size in BD Data Management. (See page 53) See if the BD-LIVE Internet Connection option is set to Allow(All). If all above fails, contact the contents provider or update to the latest firmware. |
| When using the BD-LIVE service, an error occurs. | <ul style="list-style-type: none"> The memory device must have at least 1GB of free space to accommodate the BD-LIVE service. You can check the available size in BD Data Management. (See page 53) |

| NOTE |

- ▶ When the factory default settings are restored, all stored user BD data will be deleted.

Repairs

If you contact us to repair your product, an administration fee may be charged if either:

1. An engineer is called out to your home at your request and there is no defect in the product.
2. You bring the unit to a repair center and there is no defect in the product.

We will provide you with the amount of the administration fee before we make a home visit or begin any work on your product.

We recommend you read this manually thoroughly, search for a solution on line at www.samsung.com, or contact Samsung Customer Care at 1-800-SAMSUNG (726-7864) before seeking to repair your product.

Appendix

| Speaker | Speaker system | 5.1ch speaker system | | | |
|---------|-----------------------------|---|-------------|-------------|--------------|
| | | Front | Surround | Center | Subwoofer |
| | Impedance | 3 Ω | 3 Ω | 3 Ω | 3 Ω |
| | Frequency range | 140Hz~20kHz | 140Hz~20kHz | 140Hz~20kHz | 40Hz ~ 160Hz |
| | Output sound pressure level | 87dB/W/M | 87dB/W/M | 87dB/W/M | 88dB/W/M |
| | Rated input | 165W | 165W | 170W | 170W |
| | Maximum input | 330W | 330W | 340W | 340W |
| | Dimensions (W x H x D) | Front : 3.54 x 8.16 x 2.69 inches Surround : 3.54 x 5.57 x 2.69 inches Center : 14.17 x 2.93 x 2.69 inches Subwoofer : 6.61 x 13.78 x 11.22 inches | | | |
| | Weights | Front : 1.59 lbs, Surround : 1.34 lbs Center : 1.94 lbs, Subwoofer : 8.09 lbs | | | |

- Samsung Electronics Co., Ltd reserves the right to change the specifications without notice.
- Weight and dimensions are approximate.
- Design and specifications are subject to change without prior notice.
- Dispose unwanted electronics through an approved recycler.
To find the nearest recycling location, go to our website: www.samsung.com/recyclingdirect or call, (877) 278 - 0799

□ SWA-5000

| | |
|-----------------------------|------------------|
| Power Requirements | AC 120V ~60Hz |
| Power Consumption | 50 W |
| Weight | 2.52 lbs |
| Dimensions (W x H x D) | 3 x 9 x 6 inches |
| Operating Temperature Range | +41°F to +95°F |
| Operating Humidity Range | 10% ~ 75% |
| Output | 165W x 2 CH |
| Frequency range | 20Hz~20KHz |
| S/N Ratio | 65dB |

LIMITED WARRANTY TO ORIGINAL PURCHASER

This SAMSUNG brand product, as supplied and distributed by SAMSUNG and delivered new, in the original carton to the original consumer purchaser, is warranted by SAMSUNG against manufacturing defects in materials and workmanship for a limited warranty period of:

One (1) Year Parts and Labor*
(*90 Days Parts and Labor for Commercial Use)

This limited warranty begins on the original date of purchase, and is valid only on products purchased and used in the United States. To receive warranty service, the purchaser must contact SAMSUNG for problem determination and service procedures. Warranty service can only be performed by a SAMSUNG authorized service center. The original dated bill of sale must be presented upon request as proof of purchase to SAMSUNG or SAMSUNG's authorized service center. Transportation of the product to and from the service center is the responsibility of the purchaser.

SAMSUNG will repair or replace this product, at our option and at no charge as stipulated herein, with new or reconditioned parts or products if found to be defective during the limited warranty period specified above. All replaced parts and products become the property of SAMSUNG and must be returned to SAMSUNG. Replacement parts and products assume the remaining original warranty, or ninety (90) days, whichever is longer.

SAMSUNG's obligations with respect to software products distributed by SAMSUNG under the SAMSUNG brand name are set forth in the applicable end user license agreement. Non-SAMSUNG hardware and software products, if provided, are on an "AS IS" basis.

Non-SAMSUNG manufacturers, suppliers, publishers, and service providers may provide their own warranties.

This limited warranty covers manufacturing defects in materials and workmanship encountered in normal, and except to the extent otherwise expressly provided for in this statement, noncommercial use of this product, and shall not apply to the following, including, but not limited to: damage which occurs in shipment; delivery and installation; applications and uses for which this product was not intended; altered product or serial numbers; cosmetic damage or exterior finish; accidents, abuse, neglect, fire, water, lightning or other acts of nature; use of products, equipment, systems, utilities, services, parts, supplies, accessories, applications, installations, repairs, external wiring or connectors not supplied and authorized by SAMSUNG, or which damage this product or result in service problems; incorrect electrical line voltage, fluctuations and surges; customer adjustments and failure to follow operating instructions, cleaning, maintenance and environmental instructions that are covered and prescribed in the instruction book; product removal or reinstallation; reception problems and distortion related to noise, echo, interference or other signal transmission and delivery problems. SAMSUNG does not warrant uninterrupted or error-free operation of the product.

THERE ARE NO EXPRESS WARRANTIES OTHER THAN THOSE LISTED AND DESCRIBED ABOVE, AND NO WARRANTIES WHETHER EXPRESS OR IMPLIED, INCLUDING, BUT NOT LIMITED TO, ANY IMPLIED WARRANTIES OF MERCHANTABILITY OR FITNESS FOR A PARTICULAR PURPOSE, SHALL APPLY AFTER THE EXPRESS WARRANTY PERIODS STATED ABOVE, AND NO OTHER EXPRESS WARRANTY OR GUARANTY GIVEN BY ANY PERSON, FIRM OR CORPORATION WITH RESPECT TO THIS PRODUCT SHALL BE BINDING ON SAMSUNG. SAMSUNG SHALL NOT BE LIABLE FOR LOSS OF REVENUE OR PROFITS, FAILURE TO REALIZE SAVINGS OR OTHER BENEFITS, OR ANY OTHER SPECIAL, INCIDENTAL OR CONSEQUENTIAL DAMAGES CAUSED BY THE USE, MISUSE OR INABILITY TO USE THIS PRODUCT, REGARDLESS OF THE LEGAL THEORY ON WHICH THE CLAIM IS BASED, AND EVEN IF SAMSUNG HAS BEEN ADVISED OF THE POSSIBILITY OF SUCH DAMAGES. NOR SHALL RECOVERY OF ANY KIND AGAINST SAMSUNG BE GREATER IN AMOUNT THAN THE PURCHASE PRICE OF THE PRODUCT SOLD BY SAMSUNG AND CAUSING THE ALLEGED DAMAGE. WITHOUT LIMITING THE FOREGOING, PURCHASER ASSUMES ALL RISK AND LIABILITY FOR LOSS, DAMAGE OR INJURY TO PURCHASER AND PURCHASER'S PROPERTY AND TO OTHERS AND THEIR PROPERTY ARISING OUT OF THE USE, MISUSE OR INABILITY TO USE THIS PRODUCT SOLD BY SAMSUNG NOT CAUSED DIRECTLY BY THE NEGLIGENCE OF SAMSUNG. THIS LIMITED WARRANTY SHALL NOT EXTEND TO ANYONE OTHER THAN THE ORIGINAL PURCHASER OF THIS PRODUCT, IS NONTRANSFERABLE AND STATES YOUR EXCLUSIVE REMEDY.

Some states do not allow limitations on how long an implied warranty lasts, or the exclusion or limitation of incidental or consequential damages, so the above limitations or exclusions may not apply to you. This warranty gives you specific legal rights, and you may also have other rights which vary from state to state.

To obtain warranty service, please contact SAMSUNG customer care center.



QUESTIONS OR COMMENTS?

| COUNTRY | CALL | OR VISIT US ONLINE AT | WRITE |
|-----------|-----------------------------|--|---|
| IN THE US | 1-800-SAMSUNG (726-7864) | www.samsung.com | Samsung Electronics America, Inc. 85 Challenger Road Ridgefield Park, NJ 07660-2112 |



AH68-02434A-03