

AKAI

STEREO CASSETTE DECK

GX-6 GX-8

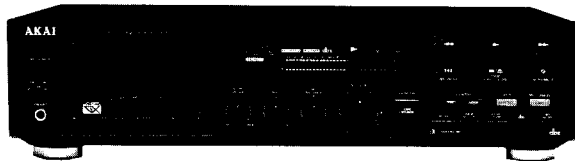

Operator's manual 5

- * Cassette tapes in the illustrations and photograph are not standard accessories.
- * This operator's manual is applicable for GX-6 and GX-8 stereo cassette deck models, except where otherwise indicated.

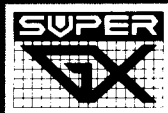

1



This is Your Akai Stereo Cassette Deck

This Akai Stereo Cassette Deck will provide excellent sound reproduction and years of reliable operation. Use it in combination with other components of the Pro Series, and you will have an excellent Hi-Fi system.

Features

- 3 head system featuring Super GX heads which incorporate LC-OFC (Linear Crystal-Oxygen Free Copper) wire
- GX-8 features closed loop dual capstan system by quartz locked direct drive system. GX-6 features closed loop dual capstan system by direct drive system
- Special chrome plated capstans
- DC playback amplifier and improved recording circuits
- High speed response and large capacity power supply with firs. recovery diode and high quality semiconductor parts
- Microcomputer controlled direct lead-in/power eject system with quick and quiet mechanism
- Bias adjustment control
- Dolby B, C and independent MPX filter switch. GX-8 includes dbx noise reduction system. The noise reduction system is a double process type especially designed for decks with 3 heads
- Wide scale 2-color FL peak level meter with peak hold system and recording level guide indicators
- Auto monitor system
- IPLS, intro scan and auto play systems
- Recording cancel and 2-way auto mute system
- Main audio circuit is LC-OFC wired.
- 3-way digital counter
- Secondary coil provides separate power supply for audio and digital circuits.
- Separate voltage regulators, one for audio circuits and one for noise reduction circuits
- 3 position auto tape selector
- Timer start function
- Large centralized FL (Flourecent lamp) display
- Damped bottom chassis and raised foot pedestals
- Large recording level control
- Gold plated LINE IN/OUT jacks

Table of contents

This is Your Akai Stereo Cassette Deck	1
What You Should Know to Protect Yourself	2
Making the Right Connections	3
Controls	4
Let's Record	5-6
Let's Play Back a Tape	7
Convenient Playback Features of the Akai	
Stereo Cassette Deck	8
A Little Know-how Goes a Long Way	9
Absentee Recording and Timed Playback	10
Operation Details	11-13
Let's Take Good Care of Your Cassette Tapes	14
... and Take Good Care of Your Stereo	
Cassette Deck too	15
Let's Check First	16
Specifications	17

WARNING

To prevent fire or shock hazard, do not expose this appliance to rain or moisture.

Power requirements

Power requirements for electrical equipment differ from area to area. Please ensure that your machine meets the power requirements in your area.

If in doubt, consult a qualified electrician.

120 V, 60 Hz for USA and Canada

220 V, 50 Hz for Europe except UK

240 V, 50 Hz for UK and Australia

110 V/120 V/220 V/240 V, 50 Hz/60 Hz convertible for other countries.

Voltage conversion

(Not on some models)

Models for Canada, USA, Europe, UK and Australia are not equipped with this facility. Each equipment is preset at the factory according to its destination, but some equipments can be adjusted to 110 V, 120 V, 220 V or 240 V as required.

If your equipment's voltage can be converted:

Before connecting the power cord, turn the VOLTAGE SELECTOR located on the rear panel with a screwdriver until the correct voltage is indicated.

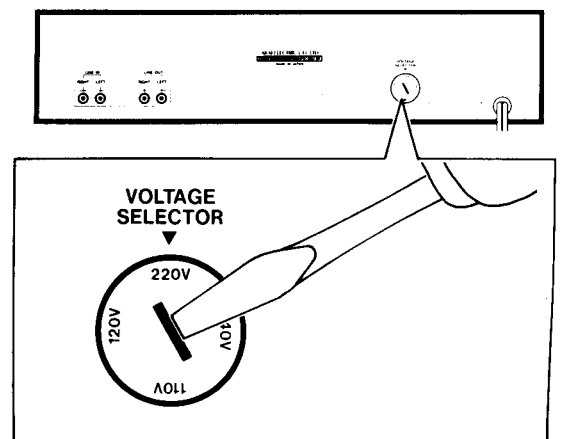

This equipment conforms to No. 82/499 EEC standards.

What you should know to protect yourself

Watch out! you might get an electric shock.

- Never touch the plug with wet hands.
- Always pull out by the plug and never the cord.
- Only let a qualified professional repair or reassemble the Akai stereo cassette deck. An unauthorized person might touch the internal parts and receive a serious electric shock.
- Never allow a child to put anything, especially metal, into the Akai stereo cassette deck.

Let's protect the Akai Stereo Cassette Deck too.

- Use only a household AC power source. Never use a DC power source.
- If water is spilled on the Akai stereo cassette deck, disconnect the power and call your dealer.
- Make sure that the Akai stereo cassette deck is well ventilated and away from direct sunlight.
- To avoid damage to the internal circuits and the external surface, keep away from heat (stoves, etc.).
- Avoid using spray type insecticide near the Akai stereo cassette deck. It can damage the finish and might ignite suddenly.
- To avoid damaging the finish, never use paint thinner or other similar chemicals to clean the Akai stereo cassette deck.
- Place the Akai stereo cassette deck on a flat and solid surface.
- **If you don't plan to use the Akai cassette deck for a long period of time, disconnect the power cord.**

To enjoy the Akai stereo cassette deck for a long time, please read this operator's manual thoroughly.

Dew formation

Dew is the term used for the formation of moisture on the very important tape transport sections such as the heads and the capstans, when the deck is used in places where humidity is high, or moved from a cold place to a warm one. If the deck is used when dew is present, the tape will stick to the head and be ruined, or it will not be transported properly. In that case, do not use the deck for approximately one hour until the deck is acclimatized.

Placement

If the deck, tuner and amplifier are placed on top of each other, humming noise may result during playback. Also beat noise may result during recording of AM broadcasts. In this case, change the position of the deck. Akai recommends that a space the size of an amplifier be placed between the deck and the tuner or the amplifier.

3



Making the Right Connections

Check first

- Turn off all the components before connection.
- Connect the power cord last.
- Make sure that you connect the white PIN-plugs to the left (L-white) jacks and the red PIN-plugs to the right (R-red) jacks.
- Connect everything securely. Loose connections can lead to distortion.

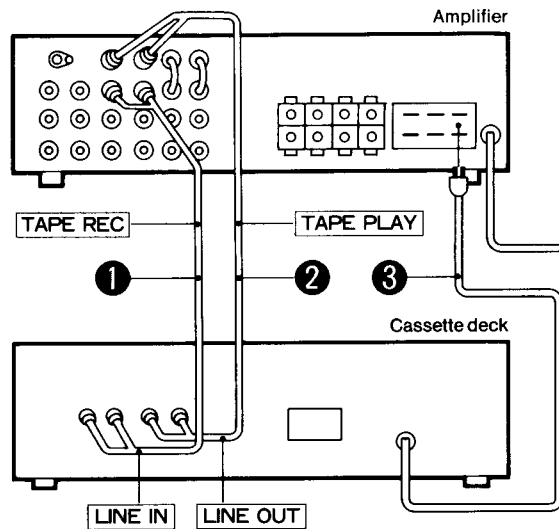
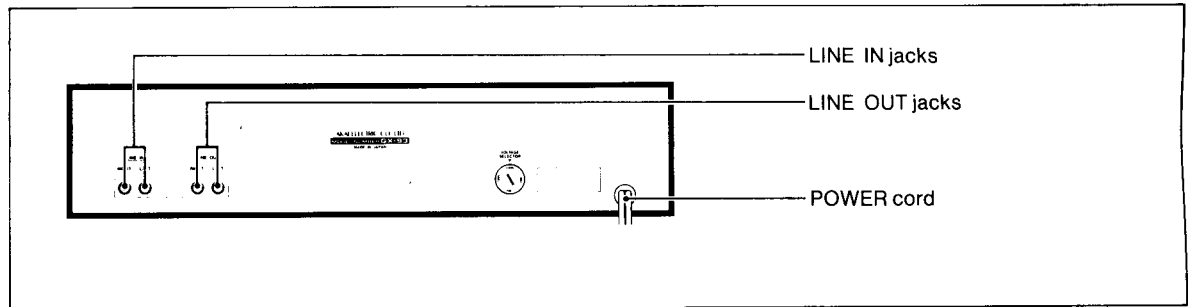

- 1 Connect the LINE IN (input) jacks to the REC (tape output) jacks of the amplifier with the standard accessory connection cord.
- 2 Connect the LINE OUT (output) jacks to the PLAY (tape input) jacks of the amplifier with the standard accessory connection cord.

After you have connected everything

- 3 Connect the power cord to a timer, amplifier or household AC outlet.



This is the Akai Stereo Cassette Deck 4

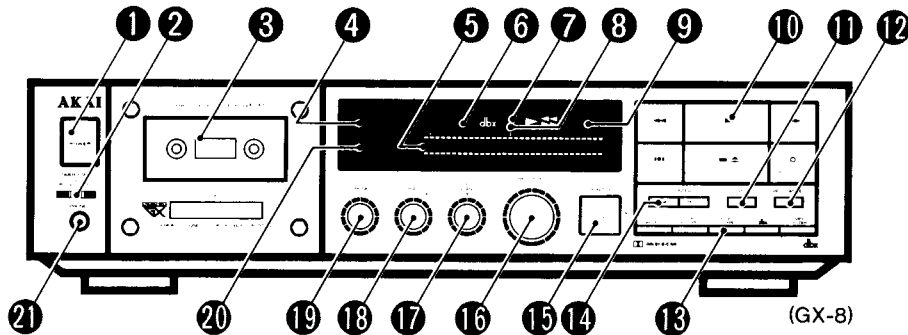

1 POWER Switch

To turn ON and OFF the power.

2 TIMER START selector

For absentee recording and timed playback.

3 Cassette holder and cassette lid (Power assisted)

Load a cassette tape here. To open, press the STOP/EJECT CLOSE (■/▲) button. To close, press once again.

Do not manually open this cassette holder, as it may damage your equipment.

4 Digital counter and counter mode display (ELAPSED/REMAIN)

Tape counter shows tape running time, elapsed time and tape remaining time.

When the power is turned off, the digital counter resets to "0" and the mode is set for tape counter.

5 Peak level meter and recording level guides

Shows playback and recording peak levels. The proper recording level is marked by fine dotted lines (recording level guides) visible on the peak meter, which vary according to tape position and type of noise reduction used.

6 Noise reduction display DOLBY NR B, C and FILTER (GX-8 includes dbx noise reduction)

Shows which noise reduction is engaged and if MPX filter switch is engaged.

7 Cassette deck mode display (REC, ◀▶, and ▶)

Shows cassette deck's operation mode (recording, playback or tape winding).

8 IPLS display

Shows IPLS (Instant Program Locating System) is engaged.

9 Monitor Mode display (TAPE/SOURCE)

Shows MONITOR switch mode.

10 Operation buttons

STOP/EJECT CLOSE (■/▲), REC PAUSE (●●), Play (▶), AUTO MUTE (○), Rewind (◀◀) and Fast Forward (▶▶) buttons for playback and recording operations.

Do not attempt to open or close the cassette holder manually.

Press the STOP/EJECT CLOSE (■/▲) button to open and close the cassette holder.

11 IPLS button

To select playback with the IPLS system.

12 REC CANCEL button

To cancel recording and rewind tape to the first detectable blank space of tape. Convenient for re-recording a section of tape.

13 Noise reduction selector (NR OFF, DOLBY B, DOLBY C, and MPX FILTER switch (dbx noise reduction on GX-8 only))

To select noise reduction for recording and playback purposes. The MPX FILTER switch eliminates pilot tones from FM stereo signals.

* The NR OFF switch does not turn the MPX filter OFF, to do so press the MPX filter switch once again.

14 COUNTER RESET/MODE select button

To reset the digital counter to "0", and to change the display mode of the digital counter.

15 MONITOR TAPE/SOURCE switch

To select the monitor mode either from a connected amplifier or through this cassette deck's headphones.

This cassette deck is incorporated with an auto monitor system. If set for SOURCE and tape operation buttons (except AUTO MUTE button) are pressed, the MONITOR switch automatically changes to TAPE.

16 REC LEVEL control

To set recording levels. The level adjustment is the same amount for both right and left channels.

17 REC BALANCE control

To set the left and right channel balance of recording input levels.

18 BIAS control

To set the recording bias current. The bias adjustment range is between -20% and +20% of the proper bias current of each tape position. If using a reference tape recommended for use with Akai cassette decks, set this control to the center click "0" position.

19 OUTPUT/PHONES control

To adjust the output level of the cassette deck.

* This control adjusts the LINE OUT and PHONES jack output levels.

20 Tape position display (METAL, CrO₂, NORM)

Shows position of the loaded cassette tape.

21 PHONES jack

To listen through a pair of headphones, connect them to this jack.

5



Let's Record

Get ready

- Set the TIMER START selector to OFF.
- Depress the POWER switch to turn on your stereo cassette deck.
- To stabilize the stereo cassette deck, the tape operation buttons will not function for approximately 4 seconds after the stereo cassette deck is turned on.
- Set the amplifier's input selector or the REC OUT selector to the recording source.
- For normal recording purposes, set the MPX filter switch to OFF.

ATTENTION

WHILST THIS CASSETTE DECK OFFERS A RECORDING FACILITY, AKAI WISHES TO POINT OUT THAT THE TAPING OF COPYRIGHT MATERIAL REQUIRES PRIOR CONSENT FROM THE COPYRIGHT OWNERS.

1 Press the **STOP/EJECT CLOSE** (■/▲) button and load a cassette tape. (Insert exposed tape side down).

2 Select the **noise reduction system** you wish to use. Refer to page 12 for details.

3 Press the **REC PAUSE** (■) button. (At this time the cassette holder will close automatically if you haven't already closed it.) The REC indicator will light and Play (▶) indicator will begin flashing to indicate the **recording standby mode**. The MONITOR switch is automatically set for the SOURCE monitoring mode.

4 Adjust the **recording level** with the REC LEVEL control, and REC BALANCE control if necessary. Basically, adjust the REC LEVEL control to set the recording level so it does not exceed the recording level guides on the peak level meter.

5 To begin recording, press the Play (▶) button.

6 To stop recording, press the STOP/EJECT CLOSE (■/▲) button.

If you want to play back a just recorded section quickly

Press the IPLS button before you begin recording. After recording, press the Rewind (◀◀) button, the just recorded section will be detected and played back.

* Refer to page 8 for IPLS details.

To cancel a just recorded section Use the REC CANCEL button

Press the REC CANCEL button while the tape deck is in the recording mode.

This cassette deck will rewind the tape to the beginning of the just recorded section, then stand by for recording after creating 4 seconds of blank space.

To resume recording

Press the Play (▶) button.

If you don't want to create 4 seconds of blank space when using the recording cancel system

Press the REC PAUSE (■) button when the REC indicator first appears on the FL display immediately after the tape has rewound. The cassette deck will go into the

Notes on REC CANCEL

- In order for recording cancel to function properly, there must be 4 seconds or more of blank space at the beginning of the selection. To create blank spaces between selections, use the AUTO MUTE (O) button during the REC PAUSE mode.
- In some recordings, such as in classical music, there may be breaks of 4 seconds or more during a selection. Or there may be some parts when the sound is at a low volume for 4 seconds or more. Such sections may be detected as blank spaces during recording cancel.

The BIAS control

This tape deck is equipped with a BIAS control which can adjust the recording bias current from a range of -20% to +20% of the proper current for each tape position. Refer to the chart to set the BIAS control properly for each tape position.

Note

Avoid setting the BIAS control to the maximum + or - positions, since the frequency characteristics of the tape will change too sharply.

Comparing source signals and just recorded signals

It is necessary to compare the original and just recorded signals in order to properly adjust the BIAS, REC BALANCE, and REC LEVEL controls. To compare source signals and recorded signals while recording, it is necessary to switch the monitor mode between SOURCE and TAPE and listen for sound variation. To do so, press the MONITOR switch.

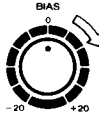
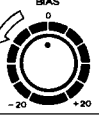
Condition	Problem	BIAS adjustment
High frequency signals are proportionately strong (stressed) in comparison to the low and mid signals.	BIAS is lower than the proper bias current for that tape type.	Turn BIAS control toward + (increase) while monitoring the source. 
Low and mid frequency signals are proportionately strong (stressed) in comparison to high signals.	BIAS is higher than the proper bias current for that tape type.	Turn BIAS control toward - (decrease) while monitoring the source. 

Standard reference tapes for this cassette deck

Types of tape	Reference tapes	
Normal position	MAXELL	UD*
CrO ₂ position	TDK	SA*
Metal position	TDK	MA*

- * Normally, set the BIAS control to "0" when using one of the standard reference tapes listed.
- * Only C-60 (60 minute) tapes with this mark are the standard reference tapes.

What is an Auto Monitor system ?

The independent recording and playback heads in combination with two independent amplifiers (one for recording and another for playback) let you listen to recording as it is being made. This is called tape monitoring. By switching the tape monitor system during recording, you can compare the just recorded music (TAPE position) to the source music (SOURCE position). In this way you can make sure that you have set the recording input levels correctly. The tape monitoring system of this cassette deck is called an "Auto Monitor System". Besides letting you manually set the tape monitor system, it also does it automatically. When the cassette deck is recording, the auto monitor system is set automatically to TAPE. During recording standby, it is automatically set to SOURCE. Therefore, under normal circumstances there is no need for you to set the MONITOR switch yourself.

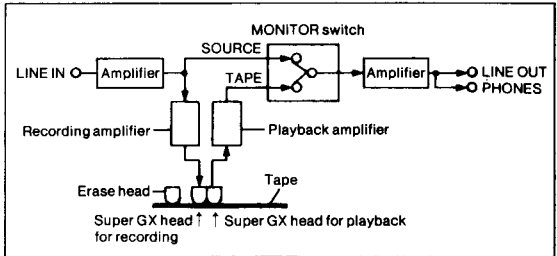

7



Let's Play Back a Tape

Get ready

- Set the TIMER START selector to OFF.
- Depress the POWER switch to turn on your stereo cassette deck.
- To stabilize the stereo cassette deck, the tape operation buttons will not function for approximately 4 seconds after the stereo cassette deck is turned on.
- Set the amplifier's input selector or the tape monitor switch for tape playback.

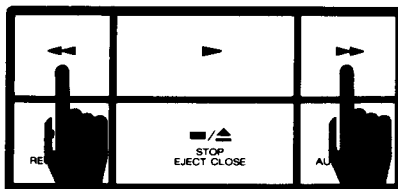
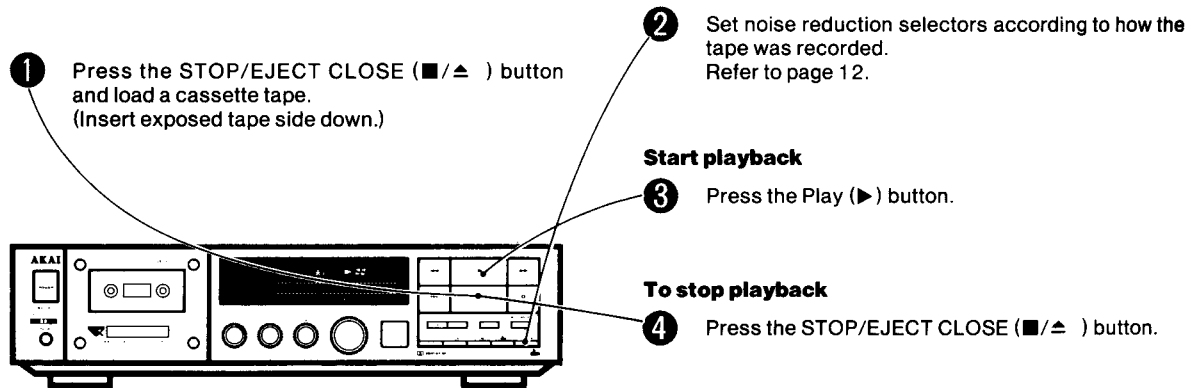

Winding the tape

To quickly wind the tape in the forward direction
Press the Fast Forward (▶▶) button.

To quickly wind the tape in the reverse direction
Press the Rewind (◀◀) button.



Convenient Playback Features of the Akai Stereo Cassette Deck

To automatically play back from the beginning of the current or next selection (Instant Program Locating System: IPLS)

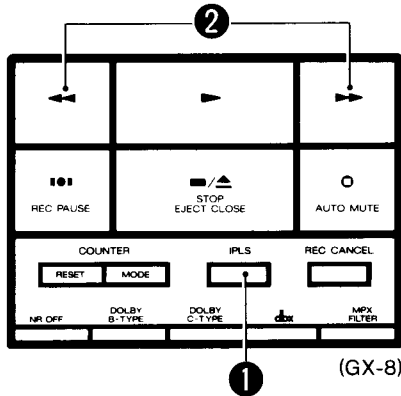

This stereo cassette deck will find the beginning of, and play back the current or next selection.

- 1 Press the IPLS button.
- 2 Press the Fast Forward (FF) button or the Rewind (RR) button as follows.
 To play back the **next** selection: Press the Fast Forward (FF) button.
 To play back the **current** selection: Press the Rewind (RR) button.

Note for IPLS function

Do not press the Fast Forward (FF) or Rewind (RR) button at the very beginning or end of a selection. The IPLS system cannot function properly.

To automatically play back the first 10 seconds of each selection (Intro Scan playback)

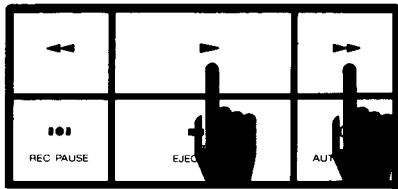

- 1 Depress the Play (P) button and the Fast Forward (FF) button simultaneously to begin Intro Scan playback.
- 2 To continue playback of a selection during Intro Scan playback, press the Play (P) button. The Intro Scan function is cancelled.
- 3 To resume Intro Scan playback, depress the Play (P) and Fast Forward (FF) buttons simultaneously.
- 4 To stop Intro Scan playback, press the STOP EJECT CLOSE (S/E/C) button.

To automatically play back from the beginning of the tape (Auto Play)

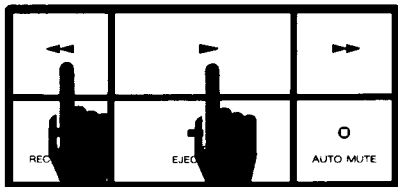

Depress the Rewind (RR) and Play (P) buttons simultaneously. The tape will rewind to the beginning, and playback will begin automatically.

Note for Auto systems

- Intro scan and IPLS systems operate when the music signals are below a specific level for a required length of time. When playing music, such as orchestral and live recorded music, some parts of the recording may contain low signals for more than the required length of time (more than 4 seconds), and will cause misoperation of some of these functions.
- In live recordings, there may be applause between the selections which is too loud to be detected as a blank space, and the Intro scan or IPLS operation cannot operate properly.



A little know-how goes a long way

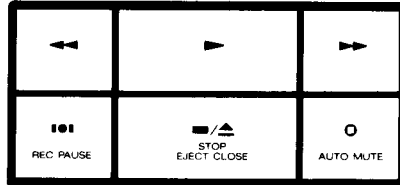

Quick Start

Quick start is to immediately record, without waiting for recording standby. Simultaneously, press the REC PAUSE (⋮⋮) and Play (▶) buttons.

To record from playback

Use this method to record an unrecorded portion of tape. You can also use this method to re-record over a recorded portion of tape.

- 1 **Start playback of the source.**
- 2 When you come to the point where you want to start recording, simultaneously depress the Play (▶) button, and the REC PAUSE (⋮⋮) button. Recording will begin immediately.

To temporarily stop recording

Press the REC PAUSE (⋮⋮) button. The stereo cassette deck will go into the recording standby mode.

To resume recording

Press the Play (▶) button.

To create blank spaces between selections

You can automatically create 4 seconds of blank space with the AUTO MUTE (○) button.

- 1 Start recording.
- 2 Press the AUTO MUTE (○) button at the end of a selection.
 - * The stereo cassette deck will create 4 seconds of blank space, then standby for recording.
- 3 To resume recording, press the Play (▶) button.

To create a blank space for an indefinite (longer) amount of time with the AUTO MUTE (○) button

Press the AUTO MUTE (○) button **twice**, successively. The REC PAUSE (⋮⋮) indicator will flash quickly during this operation.

- 1 **To stop recording**
Press the STOP EJECT CLOSE (■/▲) button.
- 2 **To stop mute recording**
Press the REC PAUSE (⋮⋮) button. The deck will go into recording standby mode.
- 3 **To resume normal recording mode**
Press the Play (▶) button.



Absentee Recording and Timed Playback

10

This cassette deck has a timer start function. When used in combination with an Akai audio timer (optional), you can record or play back a tape at a specific programmed time.

Prepare for absentee recording

- 1 Set the timer mode to EVER ON by pressing the timer mode selector, and turn on your stereo system.
- 2 Press the STOP/EJECT CLOSE (■/▲) button and load a cassette tape.
- 3 Tune in a station you want to record with the tuner.
- 4 Set the noise reduction selector.
- 5 Set the audio timer to the TIMER mode with the timer mode selector. The connected stereo components will turn off.
- 6 Set the TIMER START selector to REC.

Notes for absentee recording:

- This is not an auto reverse type cassette deck. Therefore, it is necessary for you to turn over the cassette tape after recording of one tape side has been completed, if you want to record on the other side. When performing absentee recording make certain that the tape is long enough to record the entire program.
- If recording a radio broadcast, do not forget to properly tune in the station you want to record and set the amplifier's input selector to TUNER.
- Normally, keep the VOLUME control set to the minimum position during absentee recording. If you want to listen while recording, set the VOLUME control to the normal listening level.

Prepare for timed playback

- 1 Set the timer mode to EVER ON by pressing the timer mode selector, and turn on your stereo system.
- 2 Set your amplifier's input selector to TAPE.
- 3 Press the STOP/EJECT CLOSE (■/▲) button to open the cassette holder and load a cassette tape.
- 4 Set the noise reduction selector.
- 5 Adjust the VOLUME control to suit your taste.
- 6 Set the timer to the TIMER mode. The connected components will turn off.
- 7 Set the TIMER START selector to PLAY.

Attention

After absentee recording and timed playback

Before turning ON the power of the cassette deck, set the TIMER START selector to OFF.

Power cord connection

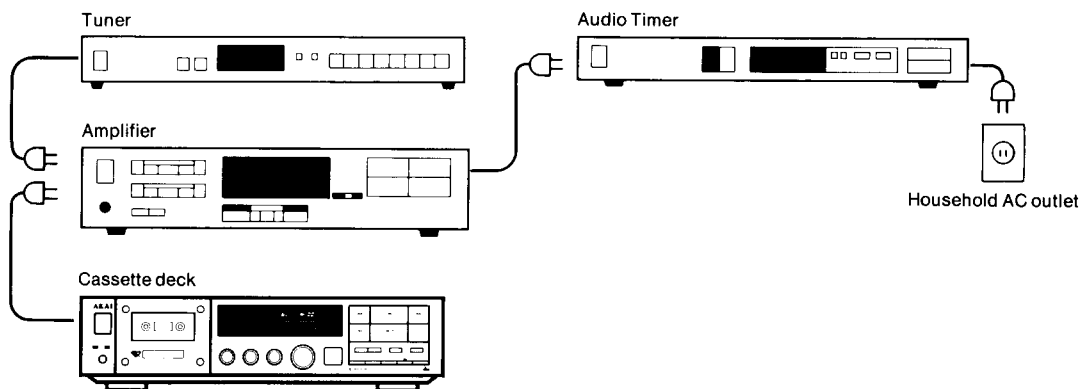

* If your amplifier is not equipped with AC outlets, connect the power cords to the timer's AC outlets.



Operation Details

How to set the correct recording input levels

Basic recording level adjustment

Basically, adjust the REC BALANCE control to set the recording level so it does not exceed the recording level guides on the peak level meter.

Notes for recording level adjustment

- The recording level guides will vary according to tape position and noise reduction used.
- Set the recording levels slightly lower, when using the DOLBY NR C-type or the dbx noise reduction system (dbx noise reduction system on GX-8 model only).

When right and left channel balance adjustment is needed:

Use the REC BALANCE control

To decrease the right channel level

Turn the REC BALANCE control to L (left).

To decrease the left channel level

Turn the REC BALANCE control to R (Right).

Normally, set the REC BALANCE control to the center click position.

Example of recording level adjustment

Using a chrome position tape (Type II)



Using a normal position tape (Type I)

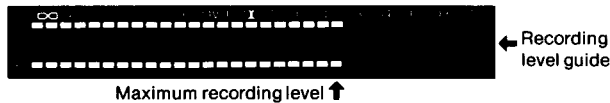

To make good recordings

To make good recordings, the recording input levels must be correct.

The recording input levels should be set as high as possible, without exceeding the recommended levels indicated on the peak level meter. If the recording levels are too high, distortion will result. If the input levels are too low, noise such as tape hiss will become noticeable. Make certain that the recording input levels match the maximum saturation levels of the music source, which can be monitored on the peak level meter.

Monitor the input source signals by pressing the REC PAUSE (●●) button before recording, and monitoring the maximum recording level indications on the peak level meter. Adjust the REC LEVEL control accordingly.

Adjusting the REC LEVEL control during recording

The recording input levels should be set according to the type of tape used, but also set them according to the music source.

Compared with music containing mostly vocals, music containing mostly strings, pipe organs, pianos, percussions, etc. have signals in the high levels which are distributed widely over the frequency range, even up to the highest frequencies. Therefore, if the recording input levels of music containing mainly vocals are set at the same level as the orchestral music, the high frequencies

The Digital Tape Counter

The 3-way digital tape counter allows great flexibility when recording and indexing your tapes.

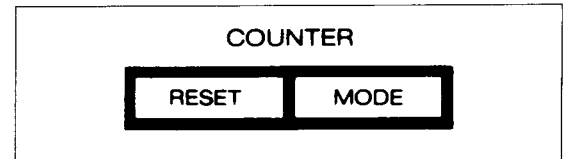

ELAPSED time counter:

Tells you in min and sec how much time has elapsed since the beginning of playback or recording.

To use the ELAPSED time counter from a section other than the beginning of a tape side, be certain to press the RESET button before you begin.

REMAIN time counter:

Tells you in min and sec how much time is remaining on the unplayed portion of the tape side.

Tape counter:

Allows you to index recordings.

Instructions for use:

- 1 Press the MODE button until the counter you wish to use appears on the display.
- 2 Press the RESET button to return to "0000" setting.
- 3 Press any tape transport button to begin-counting.

Counter notes:

- The tape counters are intended as a guide only and are not an exact measurement of real time.
- The tape time REMAIN mode automatically senses the amount of tape remaining whenever the Play button is pressed. The tape time REMAIN display returns to " - - - " only when the cassette tape is removed.
- This cassette deck automatically senses and selects the length of the cassette tape as a 46, 60 or 90 minute cassette tape.
- When the digital counter is set for time REMAIN, it is not possible to reset the tape counter to "0".

Set the proper noise reduction system before all recording and playback operations

When playing back a tape, set the noise reduction selector to the type you used when recording the tape. Set the noise reduction selector to OFF when a tape was recorded without the use of a noise reduction system.

What is the DOLBY Noise Reduction (NR) System?

When you record without the DOLBY NR system, you can't hear the soft sounds very clearly because they are masked by noise added by the tape during recording. The DOLBY NR system reduces this annoying tape noise. The DOLBY NR encoder circuit boosts the low-level signals (soft sounds) during recording and playback, the DOLBY NR decoder lowers the low-level signals by exactly the same amount to restore the low-level signals to their original levels. At the same time, tape noise is lowered by the same amount. The result is reduction only in unwanted tape noise.

What is the difference between DOLBY B-type and C-type NR systems?

- B-type:** This is the conventional DOLBY NR system. It boosts or lowers the low-level signals at high frequencies only (more than 5 kHz) and reduces tape noise by 10 dB.
- C-type:** Compared to the DOLBY NR B, it operates at lower frequencies (from 500 Hz) for uniform noise reduction across more of the audible spectrum. Tape noise is reduced by as much as 20 dB.

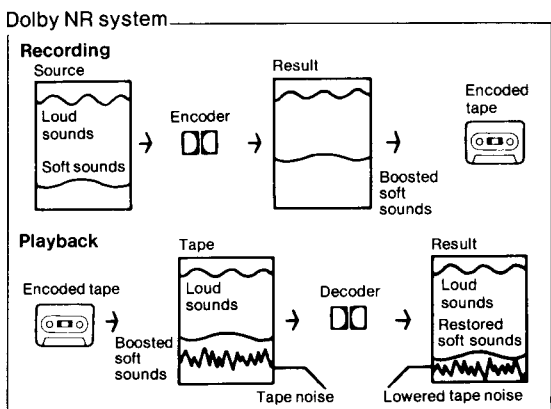

* "DOLBY" and the double-D symbol are trademarks of DOLBY Laboratories Licensing Corporation. (Noise reduction manufactured under license from Dolby Laboratories Licensing Corporation.)

What is a double process noise reduction system?

In a conventional noise reduction system, one circuit acts both as an encoder and decoder, and is switched to one or the other accordingly. The double process noise reduction system has an encoder circuit in the recording amplifier section, and a decoder in the playback amplifier section. The double process noise reduction system is used in cassette decks with 3 independent heads (recording, playback, and erase). Therefore, when recording with a noise reduction system, you can immediately confirm the effect of the noise reduction by monitoring the just recorded music.

The dbx Noise Reduction system (On GX-8 deck only)

dbx is a High Compander noise reduction (NR) system which improves the dynamic range of the tape. The dbx system has a compression/expansion ratio of 2. During recording, the signals are "compressed" by 1/2 and, later during playback, they are expanded by the same amount (i.e. a ratio of 2), which returns them to their original state. The compression of the signals results in extended saturation level of the tape (by approximately 10 dB), the expansion of the signals results in a reduction of tape noise by 30 dB to 40 dB across the entire audible range. Therefore, by using the dbx NR system, dynamic range of more than 110 dB (at 1 kHz) can be realized. Use the dbx noise reduction system when using a compact disc player as a recording source, for example. When playing back tapes not recorded with dbx NR, set this switch off.

dbx Encoder

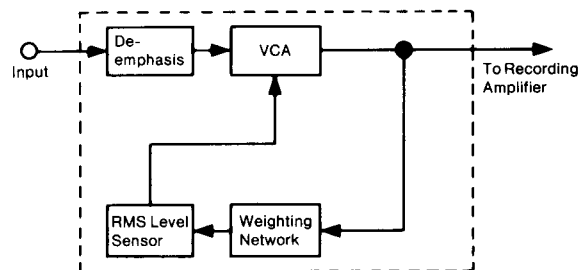

dbx Decoder

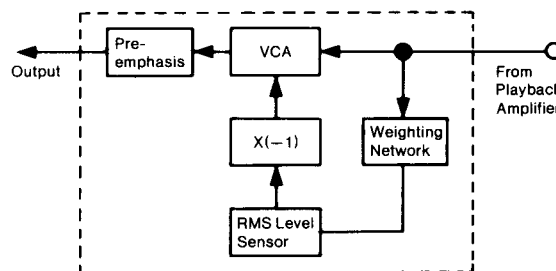

* dbx is a trademark of dbx incorporated.

When high frequency signals are over-emphasized during FM stereo recording

Use of a noise reduction system alone is not enough. In this case, it is necessary to set the MPX FILTER switch ON.

What is the MPX FILTER?

FM stereo signals contain 19 kHz pilot signals and 38 kHz subcarrier signals which convey the left and right channel information. These signals are necessary, but they must be removed from the output signals of the tuner. If these signals are not removed, they can affect the DOLBY NR system and dbx noise reduction systems. The MPX filter is designed to remove these pilot tone signals before they can be recorded.

When to use the MPX FILTER switch

Use this switch only when you are recording with DOLBY NR or dbx noise reduction systems. Most high quality tuners have filters to suppress FM pilot tone signals, with these tuners, you can leave the MPX FILTER switch OFF. With tuners that do not have filters, or those with inadequate filters, you should turn ON the MPX FILTER switch. Or, when you monitor the just recorded music and feel that the sound quality is not right, turn on the MPX FILTER switch. At other times, leave it OFF.

Note

The NR OFF switch turns off the MPX FILTER. However, the FILTER display will not disappear unless you press the MPX FILTER switch once again.

To make copy from an original tape (Tape dubbing)

Normally, connect both cassette decks to the amplifier. Refer to the amplifier's operator's manual for operation details.

It is also possible to connect directly, deck to deck.

Set the recording controls (noise reduction, recording level, etc.) exactly as you would for standard recording.

If you use this cassette deck as the master (source) deck, make certain to set the OUTPUT/PHONES control to MAX.

The Peak Level meter

The peak level meter shows the peak (maximum) level of recording and playback signals. By monitoring the peak level, it is possible to set the recording controls of this deck to realistically reproduce the dynamic characteristics of the original source.

The standard recording level of this meter is indicated at 0 dB at a level of 250 nwb/m.

This peak level meter conforms to IEC standards.

Peak hold indicators

Peak hold indicators show the maximum recording signal levels which constantly change according to the source signals. The peak hold indicators help guide you when setting the REC LEVEL control.

Let's Take Good Care of Your Cassette Tapes . . .

Recording defeat tabs

To protect important recordings from being accidentally recorded over, cassette tapes are equipped with recording defeat tabs. There is one tab for each side. To record again, cover the holes with adhesive tape. When using metal or chrome position cassette tapes, make sure that you do not cover the notches for triggering their tape positions. If they are covered, the auto tape selector will not function properly.

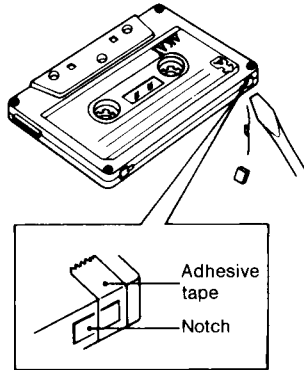

Tape slack

Tape slack can cause the tape to twist or tangle around the pinch roller and capstan and ruin important recordings.

This cassette deck is equipped with a tape rewind function which automatically takes up tape slack immediately after the tape is loaded.

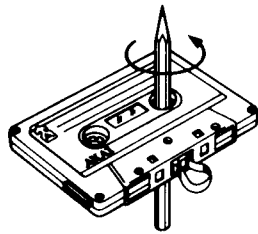

Handling

- Do not touch the tape with your fingers as high frequency signals cannot be recorded in places which are not clean.
- Do not leave the cassette tape near equipment which generates a magnetic field. (TV, speaker system, etc.)

Storage

- Always put the cassette tape back into its plastic case. Store it in a dry place, away from direct sunlight, heat (stove, etc.) and equipment which generates a magnetic field. (TV, speaker system, etc.)
- Store the cassette tape with the tape taken up at the fixed speed of recording or playback. When the tape is not taken up in an orderly manner (in other words, fast forwarded or rewound), the tape might stretch or warp.
- If you are not going to use the cassette tape for a long time, rewind or fast forward the tape once in a while. This is to prevent some of the music signals from imprinting themselves over other music signals when tape surfaces are in close contact for a long time. Rewinding or fast forwarding the tape also prevents moisture condensation.

Regarding cassette tapes

- We do not recommend the use of C-120 (120 minute) cassette tapes. The tape is too thin and can easily twist or tangle around the pinch roller and capstan.
- We do not recommend the use of cassette tapes of poor quality. You will not be able to fully utilize the ability of your stereo cassette deck with this type of cassette tape.
- We recommend that you use cassette tapes specifically made for recording hi-fi music.

The Auto Tape Selector

How tape positions are detected
Cassette tapes can be separated widely into three types:

normal position, chrome (CrO₂) position and metal position. Tape performances differ according to tape position and to fully utilize the performance of each tape, the cassette deck's recording/playback characteristics such as bias and equalization, must be set to suit each tape position.

The stereo cassette deck is equipped with an Auto Tape Selector which functions automatically after you have loaded a cassette tape.

How the auto tape selector operates

When a cassette tape is loaded, the stereo cassette deck detects the tape position by sensing the special notches on top of the cassette case, as illustrated.

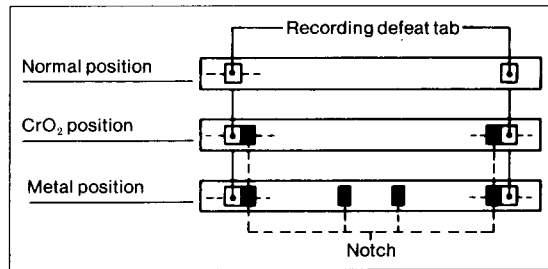

Attention

- Do not use a cassette tape which does not have notches for triggering the tape position. You will not be able to get optimum recordings.
- We do not recommend the use of ferri-chrome cassette tapes for recording.



... and Take Good Care of Your Stereo Cassette Deck too

Keep your stereo cassette deck clean

After prolonged use, parts of your cassette deck which come into contact with the tape (heads, capstans, pinch rollers, etc.) become dirty due to oxide from the tape and other contaminations.

This can lead to such problems as “no sound”, “funny sound due to unstable tape transport” etc.

Therefore, to always enjoy good performance, you should periodically clean your stereo cassette deck.

How to remove the cassette lid

- 1 Turn on the power.
Press the STOP/EJECT CLOSE (■/▲) button to open the cassette holder. Then turn off the power.
- 2 Grasp both sides of the cassette lid and gently pull up to remove.

To replace the cassette lid

- 1 Align the cassette lid with the cassette holder and push it down in the opposite direction of the arrows.
- 2 Turn on the power. The cassette lid will close automatically.

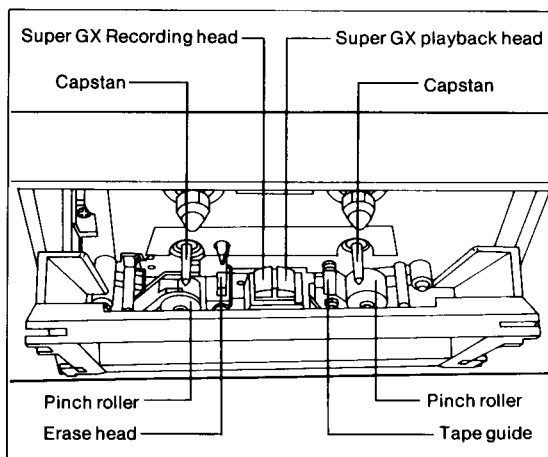
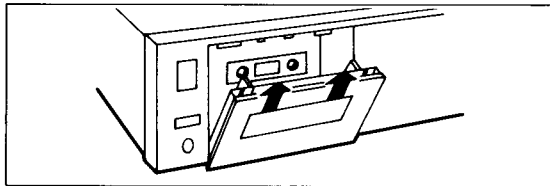

How to clean

Use the optional accessory Akai Cleaning Kit CK-310 or a cleaning tape.

- Use a liquid cleaner exclusively for tape decks. For best results, clean your stereo cassette deck before an important recording or playback.

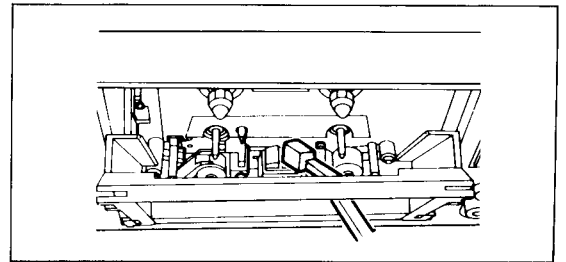

Keeping the heads demagnetized

Attention

Turn off your stereo cassette deck before demagnetizing. After much use, slight magnetism can build up on the recording and playback heads. This can cause loss in high frequency sound and increases in distortion. Therefore, you should periodically demagnetize the heads with the optional accessory Head Demagnetizer AH-15. Demagnetize the metal parts of the capstan as well.

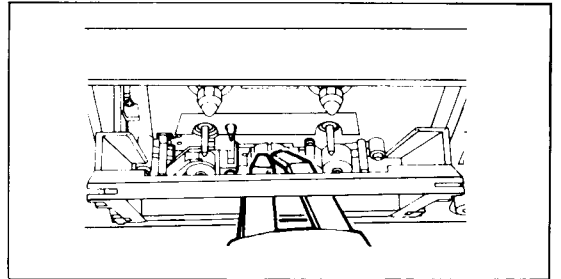

Let's keep the cabinet clean, too

- Clean the cabinet with a soft, dry cloth.
- If the cabinet is very dirty, clean it with a mild detergent.
- Never use paint thinner, etc. to clean the cabinet, they may damage the finish.

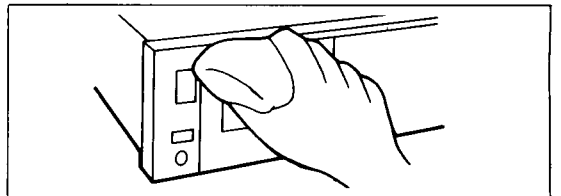



Problem? Let's check first

16

The Stereo cassette deck will not turn on	<ul style="list-style-type: none">● Check to see if the power cord is connected securely to the household, timer's or amplifier's AC outlet.
No sound	<ul style="list-style-type: none">● The connected amplifier's input selector is not set properly.● Make certain that the OUTPUT/PHONES control level is audible.
The stereo cassette deck goes into absentee recording or timed playback when it is turned on.	<ul style="list-style-type: none">● The TIMER START selector is set for REC or PLAY. Set to OFF before turning on the power.
Recording will not take place	<ul style="list-style-type: none">● The cassette tape's recording defeat tabs are broken. Cover them with adhesive tape.● Did you press both the REC PAUSE (■) button and Play (▶) button?
Distorted recording or playback	<ul style="list-style-type: none">● Recording levels are set too high. Reduce the recording level with the REC LEVEL control.● Dirty or magnetized heads. Clean and demagnetize the heads.
Unstable tape transport	<ul style="list-style-type: none">● Make sure that the pinch rollers and capstans are clean.● Check the cassette case for warpage or other problems.
Auto tape selector will not function properly	<ul style="list-style-type: none">● Make sure that the cassette tape has notches for triggering the tape position.
Recording sounds funny	<ul style="list-style-type: none">● The BIAS control is not adjusted properly.● Turn the MPX FILTER ON when recording FM stereo broadcasts.
Sound is funny during playback	<ul style="list-style-type: none">● The noise reduction selector is not set properly.
Intro scan and IPLS will not function properly	<ul style="list-style-type: none">● The blank spaces between selections are less than, 4 seconds long. Use the AUTO MUTE (○) button during recording to create the proper length of blank space.
The cassette deck goes into playback mode automatically during tape winding	<ul style="list-style-type: none">● The IPLS system is engaged.

Should a problem persist: write down the model and serial numbers and all pertinent date regarding warranty coverage as well as a clear description of the existing trouble. Then, contact your nearest authorized Akai Service Station or the Service Department of Akai Electric Co., Tokyo, Japan.



Specifications

Model	GX-8
Track system	4 track 2 channel stereo
Heads	Super GX head for recording ×1 Super GX head for playback ×1 Erase head ×1
Motors	Quartz PLL direct drive motor for capstan drive ×1 DC motor for reel drive ×1 DC motor for cam and door drive ×1
Wow & flutter	0.025% WRMS (JIS), 0.04% (DIN)
S/N (METAL)	60 dB (Measured via tape with 3% THD recording level) Dolby B type NR switch ON: Improves up to 5 dB at 1 kHz, 10 dB above 5 kHz Dolby C type NR switch ON: Improves up to 15 dB at 500 Hz, 20 dB at 1 kHz to 10 kHz
Dynamic range	110 dB (dbx ON)
T.H.D.	Less than 0.6% (Metal)
Frequency response	
NORM	20 Hz to 19,000 Hz ±3 dB
CrO₂	20 Hz to 20,000 Hz ±3 dB
METAL	20 Hz to 21,000 Hz ±3 dB
Input sensitivity/Impedance	
LINE IN	70 mV/47 kohms
Output sensitivity/Impedance	
LINE	388 mV/1 kohms
PHONES	1.3 mW(8 ohms)/82 ohms
Power requirements ..	120 V, 60 Hz for USA & Canada 220 V, 50 Hz for Europe except UK 240 V, 50 Hz for UK & Australia 110 V/120 V/220 V/240 V, 50 Hz/60 Hz convertible for other countries
Dimensions	440 (W) × 111 (H) × 353 (D) mm (17.3 × 4.4 × 13.9 inches)
Weight	6.5 kg (14.3 lbs)
Standard accessory	
Connection cords	×2

* For improvement purposes, specifications and design are subject to change without notice.

Model	GX-6
Track system	4 track 2 channel stereo
Heads	Super GX head for recording ×1 Super GX head for playback ×1 Erase head ×1
Motors	Direct drive FG servo motor for capstan drive ×1 DC motor for reel drive ×1 DC motor for cam and door drive ×1
Wow & flutter	0.025% WRMS (JIS), 0.04% (DIN)
S/N (METAL)	60 dB (Measured via tape with 3% THD recording level) Dolby B type NR switch ON: Improves up to 5 dB at 1 kHz, 10 dB above 5 kHz Dolby C type NR switch ON: Improves up to 15 dB at 500 Hz, 20 dB at 1 kHz to 10 kHz
T.H.D.	Less than 0.6% (Metal)
Frequency response	
NORM	20 Hz to 19,000 Hz ±3 dB
CrO₂	20 Hz to 20,000 Hz ±3 dB
METAL	20 Hz to 21,000 Hz ±3 dB
Input sensitivity/Impedance	
LINE IN	70 mV/47 kohms
Output sensitivity/Impedance	
LINE	388 mV/1 kohms
PHONES	1.3 mW (8 ohms)/82 ohms
Power requirements ..	120 V, 60 Hz for USA & Canada 220 V, 50 Hz for Europe except UK 240 V, 50 Hz for UK & Australia 110 V/120 V/220 V/240 V, 50 Hz/60 Hz convertible for other countries
Dimensions	440 (W) × 111 (H) × 353 (D) mm (17.3 × 4.4 × 13.9 inches)
Weight	6.5 kg (14.3 lbs)
Standard accessory	
Connection cords	×2

* For improvement purposes, specifications and design are subject to change without notice.

AKAI
AKAI ELECTRIC CO., LTD.
12-14, 2-chome, Higashi-Kojiya,
Ohta-ku, Tokyo, Japan

C E V UT

610822B1
610830-1
Printed in Japan