

Video Cassette Player

VPA115BL

VPA115PR

Owner's Manual

Important!

Return your **Warranty Registration Card** within 10 days. See why inside.



PHILIPS **MAGNAVOX**

Return your Warranty Registration card today to ensure you receive all the benefits you're entitled to.

Once your PHILIPS MAGNAVOX purchase is registered, you're eligible to receive all the privileges of owning a PHILIPS MAGNAVOX product. So complete and return the Warranty Registration Card enclosed with your purchase at once. And take advantage of these important benefits.

Warranty Verification

Registering your product within 10 days confirms your right to maximum protection under the terms and conditions of your PHILIPS MAGNAVOX warranty.

Owner Confirmation

Your completed Warranty Registration Card serves as verification of ownership in the event of product theft or loss.

Model Registration

Returning your Warranty Registration Card right away guarantees you'll receive all the information and special offers which you qualify for as the owner of your model.

PHILIPS MAGNAVOX

Congratulations on your purchase, and welcome to the "family!"

Dear PHILIPS MAGNAVOX product owner:

Thank you for your confidence in PHILIPS MAGNAVOX. You've selected one of the best-built, best-backed products available today. And we'll do everything in our power to keep you happy with your purchase for many years to come.

As a member of the PHILIPS MAGNAVOX "family," you're entitled to protection by one of the most comprehensive warranties and outstanding service networks in the industry.

What's more, your purchase guarantees you'll receive all the information and special offers for which you qualify, plus easy access to accessories from our convenient home shopping network.

And most importantly you can count on our uncompromising commitment to your total satisfaction.

All of this is our way of saying welcome-and thanks for investing in a PHILIPS MAGNAVOX product.



Sincerely,

Robert Minkhorst
President and Chief Executive Officer

P.S. Remember, to get the most from your PHILIPS MAGNAVOX product, you must return your Warranty Registration Card within 10 days. So please mail it to us right now!



Know these safety symbols



⚡ This "bolt of lightning" indicates uninsulated material within your unit may cause an electrical shock. For the safety of everyone in your household, please do not remove product covering.

⚠ The "exclamation point" calls attention to features for which you should read the enclosed literature closely to prevent operating and maintenance problems.

WARNING: TO PREVENT FIRE OR SHOCK HAZARD, DO NOT EXPOSE THIS EQUIPMENT TO RAIN OR MOISTURE.

CAUTION: To prevent electric shock, match wide blade of plug to wide slot, and fully insert.

ATTENTION: Pour éviter les choc électriques, introduire la lame la plus large de la fiche dans la borne correspondante de la prise et pousser jusqu'au fond.

For Customer Use

Enter below the Serial No. which is located on the rear of the cabinet. Retain this information for future reference.

Model No. _____
Serial No. _____

Introduction 3

Welcome to your Video Cassette Player owner's manual.

This manual has four sections: Setting Up Your VCP; Description of Controls; Operations; and Information You May Need. The instructions explain all of the VCP's features, which are listed below.

Features

- AC/DC Power System
- Automatic Head Cleaner
- Automatic Operation Features
- Automatic Tracking Adjustment
- Dew Sensor
- Display Panel
- Picture Control
- Remote Control
- Repeat Playback
- Special Effects Playback: Forward and Reverse Searching; Still

Safety Precautions

Warning: To prevent fire or shock hazard, do not expose this equipment to rain or moisture.

Federal Communications Commission (FCC) Warning: Any unauthorized changes or modifications to this equipment void the user's authority to operate it.

This VCP, equipped with a High Quality (HQ) system, is compatible with existing Video Home System (VHS) equipment. Philips Consumer Electronics Company recommends that you use only video cassette tapes that are labeled with the **VHS** mark. The use of other tapes may result in poor picture quality and excessive deposits on the video heads, which may not be covered by the warranty if damage occurs.

Note to the Cable TV System Installer: This reminder is provided to call the Cable TV system installer's attention to Article 820-40 of the National Electrical Code, which provides guidelines for proper grounding – in particular, specifying that the cable ground shall be connected to the grounding system of the building, as close to the point of cable entry as possible.

ATTENTION: Do not place the Player where it will be exposed to direct sunlight, reflected sunlight, or electric light of a level that exceeds 100 watts. The Player should be placed at least three feet from such light. Strong light may affect the sensor and cause the Player to operate strangely. For example, during tape playback, the Player may begin to rewind the tape unexpectedly if light affects the sensor.

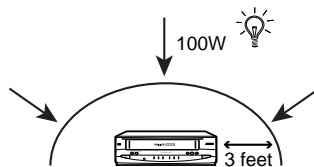

Copyright 1999 Philips Consumer Electronics Company. All rights reserved.

Helpful Hints

- Before doing anything else, record the VCP's model and serial numbers in the spaces provided on page two. These numbers will help us assist you if you ever call for help.
- Your new product, its packaging, and this manual contain materials that can be recycled and reused. Specialized companies can recycle your product to increase the amount of reusable materials and to minimize the amount that needs to be properly disposed. Your product uses batteries that should not be thrown away when depleted but should be disposed of as small chemical waste. Please find out about the local regulations on disposal of your old product, batteries, manual, and packaging whenever you replace existing equipment.

4 Table of Contents

Setting Up Your VCP

Introduction	3
Table of Contents	4
Before Using Your VCP	5
Hookups Without a Cable Box	6-7
Hookups With a Cable Box	8-9
Hookups With a Stereo TV	10
Mobile Connections	11

Description of Controls

Remote Control Buttons	12
Display Panel	13
Front Panel	14
Rear Panel	15

Operations

Playing	16
Playback Options	17-18
Automatic Operation Features	19

Information You May Need

Helpful Hints	20
Limited Warranty	21
Specifications/Glossary	22
Index	23
Accessories	24

Putting Batteries in the Remote Control

1

Remove the battery compartment lid on the bottom of the remote control by sliding the lid in the direction of the arrow.

2

Insert two AA batteries inside the battery compartment with their + and - ends aligned as indicated.

3

Replace the battery compartment lid.

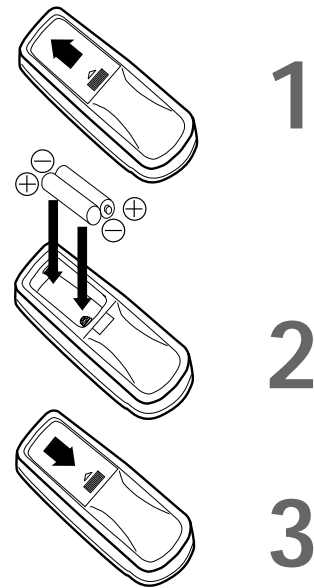

Using the Remote Control

- Point the remote control at the VCP's remote sensor when operating the VCP.
- Do not put objects between the remote control and the VCP.

VCR Maintenance

- Use only tapes with the **VHS** mark.
- Remove any light adhesive stick-on notes from the video cassette tape before putting the tape in the VCP. Removable labels can jam the VCP.
- Periodic maintenance is required to maintain your VCP's excellent performance. This VCP has an Automatic Head Cleaner. However, the video heads will require replacement eventually. Only an authorized service center should perform this service.

Types of Video Cassette Tapes

The chart below shows the playback time for three types of video cassettes (T160, T120, and T60). There are three playback speeds: SP, LP, and SLP.

Tape Speed	Cassette type/Playback Time		
	T160	T120	T60
SP (standard play)	2 hrs. 40 mins.	2 hrs.	1 hr.
LP (long play)	5 hrs. 20 mins.	4 hrs.	2 hrs.
SLP (super long play)	8 hrs.	6 hrs.	3 hrs.

Helpful Hints

- The remote control and its batteries are supplied.
- Do not mix alkaline and manganese batteries.
- Do not mix old and new batteries.

6 Hookups Without a Cable Box

The basic VCP/TV connection – antenna/cable to VCP to TV – is shown below. If you have a Cable Box, please refer to pages eight-nine. If you have a Stereo TV, please go to page 10. To use the VCP in an automobile, go to page 11.

1

Disconnect the antenna or cable from your TV.

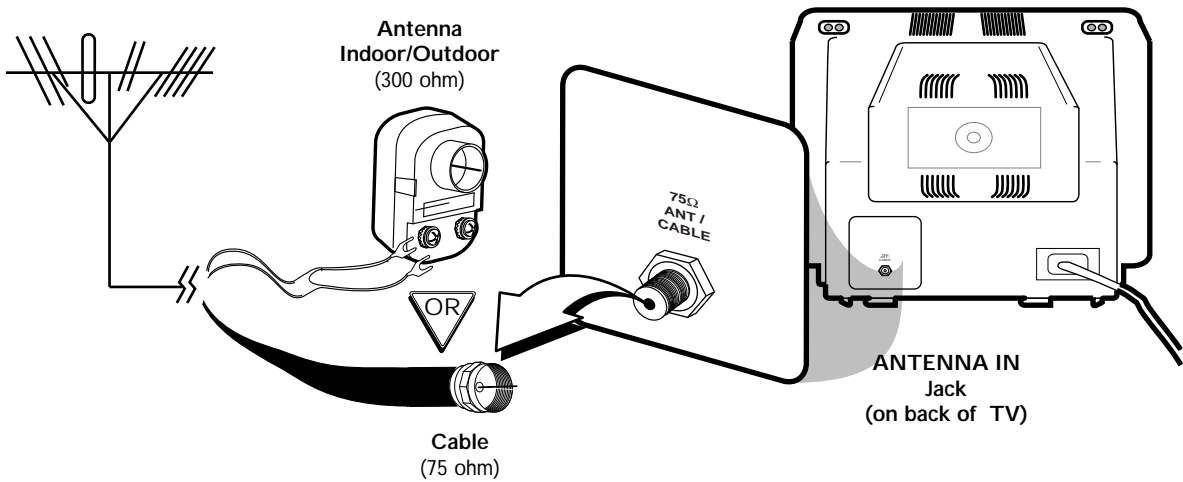

2

Connect the antenna or cable to the ANT(enna) IN jack of your VCP.

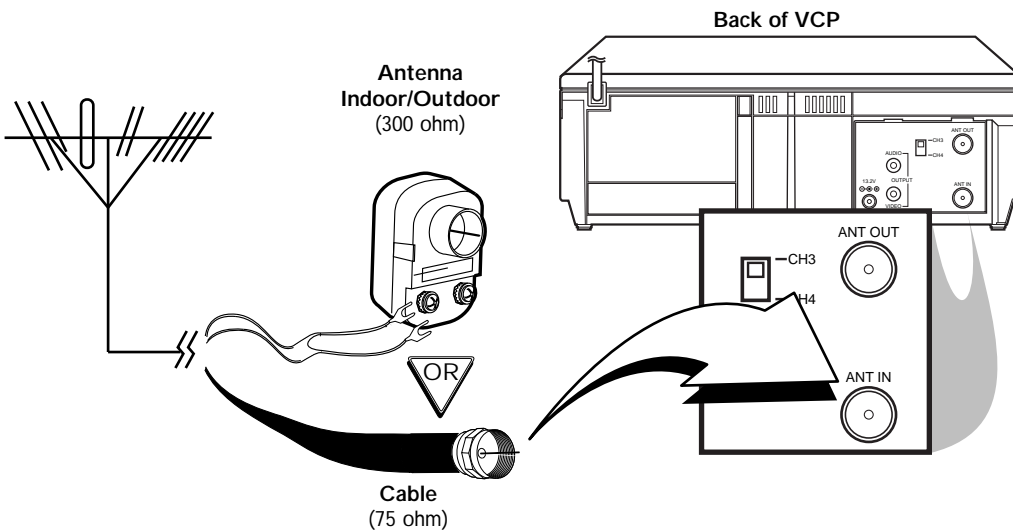

Hookups Without a Cable Box (cont'd) 7

3

Connect the RF coaxial cable (supplied) to the ANT(enna) OUT jack on the back of the VCP and to the ANTENNA IN Jack on the TV. (You may use either a snap-on type or screw-on type of coaxial cable, whichever you prefer. A snap-on type is supplied.)

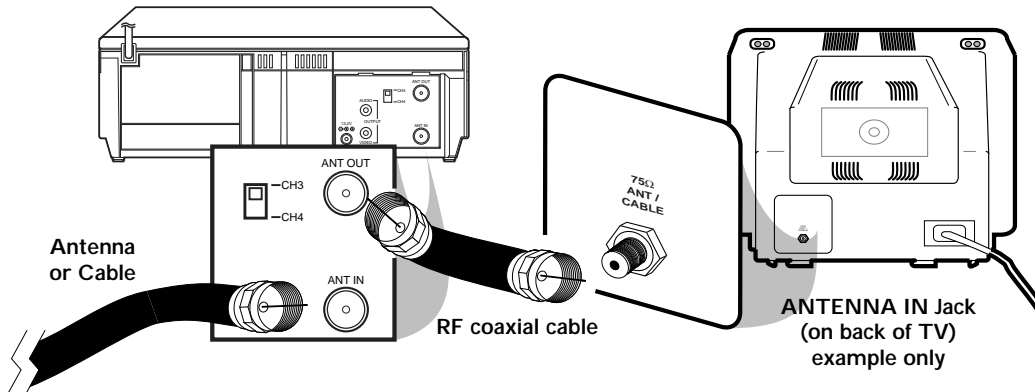

4

Plug in the TV and the VCP.

5

Set the CH3/CH4 switch on the back of the VCP to CH3 or CH4, whichever channel is not used or least used in your area. To operate your VCP with your TV, set the TV to the same channel. For example, when playing a tape, if the CH3/CH4 switch is set to CH3, the TV should be on channel 3.

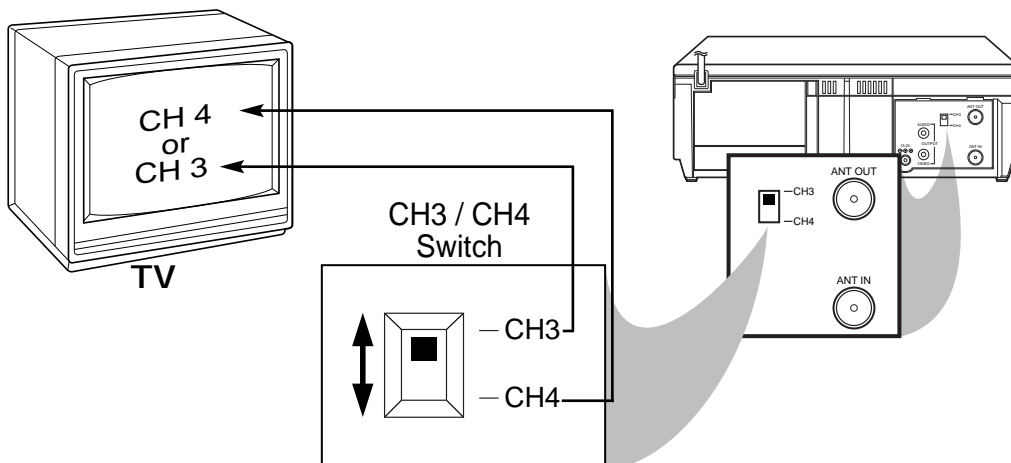

6

You are ready to turn on the VCP.

8 Hookups With a Cable Box

This connection allows you to view any channel. You must select channels at the Cable Box.

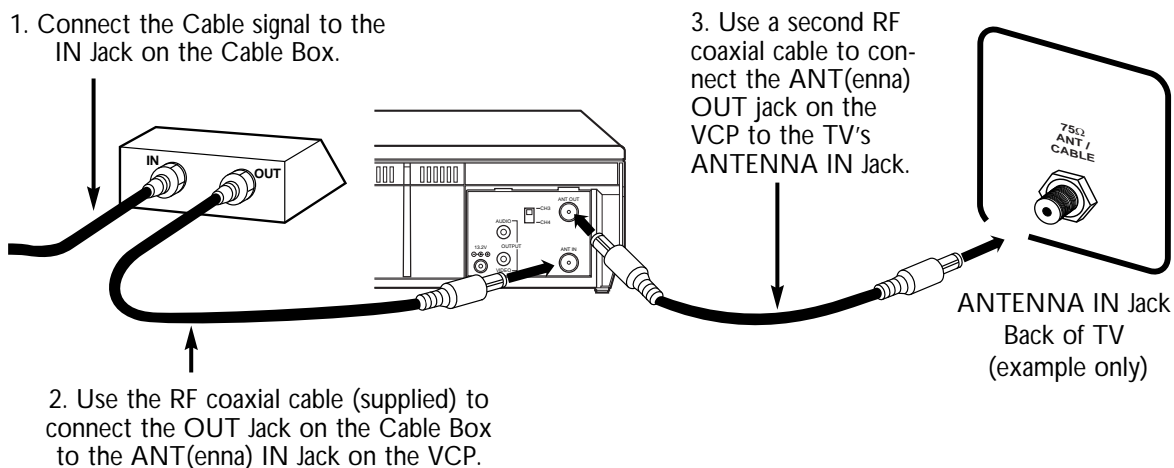

Watching TV with the VCP Off

1

Set the TV to the Cable Box output channel (channel 3 or 4).

2

Select the channel you want to watch at the Cable Box. You can not select channels at the TV.

Playing a Tape

1

Set the TV to channel 3 or 4, whichever channel the CH3/CH4 switch on the VCP is set to.

2

Press the PLAY button to play the tape.

Hookups With a Cable Box (cont'd) 9

.....
This connection differs from the one shown on page eight. You may still view any channel (selecting channels at the Cable Box), but the instructions for playing a tape are different.

1. Connect a Cable signal to the VCP's ANT(enna) IN Jack.

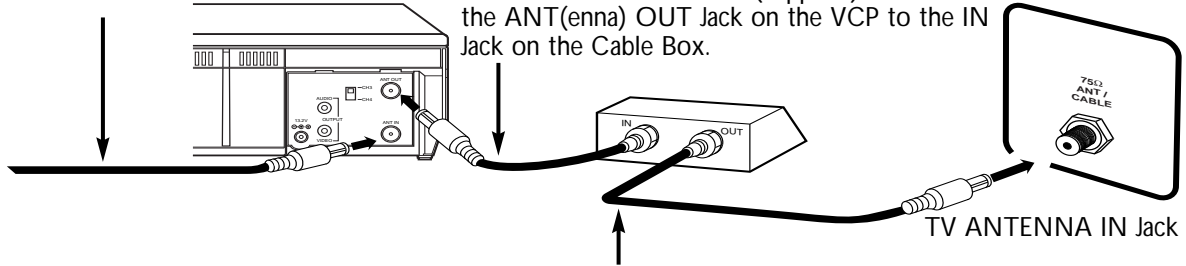

2. Use an RF coaxial cable (supplied) to connect the ANT(enna) OUT Jack on the VCP to the IN Jack on the Cable Box.

3. Use a second RF coaxial cable to connect the OUT Jack on the Cable Box to the ANTENNA IN Jack on the back of the TV.

Watching TV with the VCP Off

1

Set the TV to the Cable Box output channel (channel 3 or 4).

2

Select the channel you want to watch at the Cable Box.

Playing a Tape

1

Make sure the Cable Box is on the same channel as the VCP's CH3/CH4 switch.

2

Set the TV to the Cable Box output channel (channel 3 or 4).

3

Press the PLAY button to play the tape.

10 Hookups With a Stereo TV

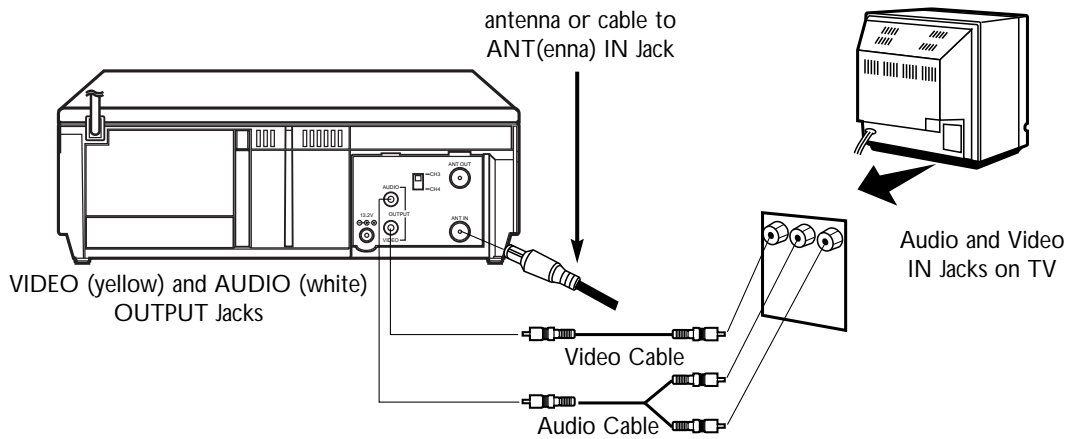

- Audio and Video cables are not supplied.

1

Connect the antenna or cable to the ANT(enna) IN Jack on the back of the VCP.

2

Connect a video cable to the yellow VIDEO OUTPUT Jack on the back of the VCP. Then, connect the other end of the video cable to the VIDEO IN Jack on your TV.

3

Connect an audio cable to the white AUDIO OUTPUT Jack on the back of the VCP. Then, connect the other end of the audio cable to the AUDIO IN Jack on your TV. (If your TV has Right and Left AUDIO IN Jacks, you must use a "Y" splitter audio cable as illustrated to deliver audio to the TV's left and right channels.)

4

Turn on your TV, making sure it is in Line Input mode. Please refer to your TV owner's manual for details.

Helpful Hint

- This hookup will not give you stereo sound. To get stereo sound, use the connections on pages six-nine and select the channel to be viewed at the TV or the Cable Box (with the VCP turned off).

Mobile Connections 11

When passengers in your vehicle want to watch a video program, hook up the VCP by following the steps below.

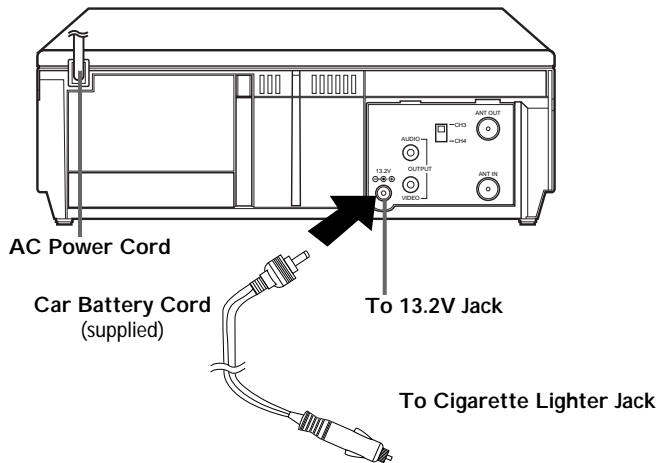

1

Make sure your vehicle has a 13.2-volt, negative ground electrical system. Unplug the AC power cords of the VCP and the TV.

2

Connect one end of the car battery cord to the 13.2V Jack on the back of the VCP.

3

Connect the other end of the car battery cord to the cigarette lighter jack in your vehicle.

4

Follow step 3 on page seven to connect the VCP to a TV.

5

Connect the TV to a DC power source. The TV must have an AC/DC Jack.

Helpful Hints

- Do not watch TV while driving.
- Use only the supplied car battery cord. Using another cord could damage the VCP or cause faulty operation.
- Make sure the cigarette lighter jack is free of ashes and other debris.
- Make sure you push the car battery cord's plug completely into the cigarette lighter jack.
- Always unplug the car battery cord from the cigarette lighter jack before you unplug it from the VCP.
- You must disconnect the car battery cord from the VCP before you can use standard AC electrical power.
- If the vehicle's engine is off, there will not be enough electrical voltage to operate the VCP.
- Unplug the car battery cord from the cigarette lighter jack when you have finished using the VCP.

12 Remote Control Buttons

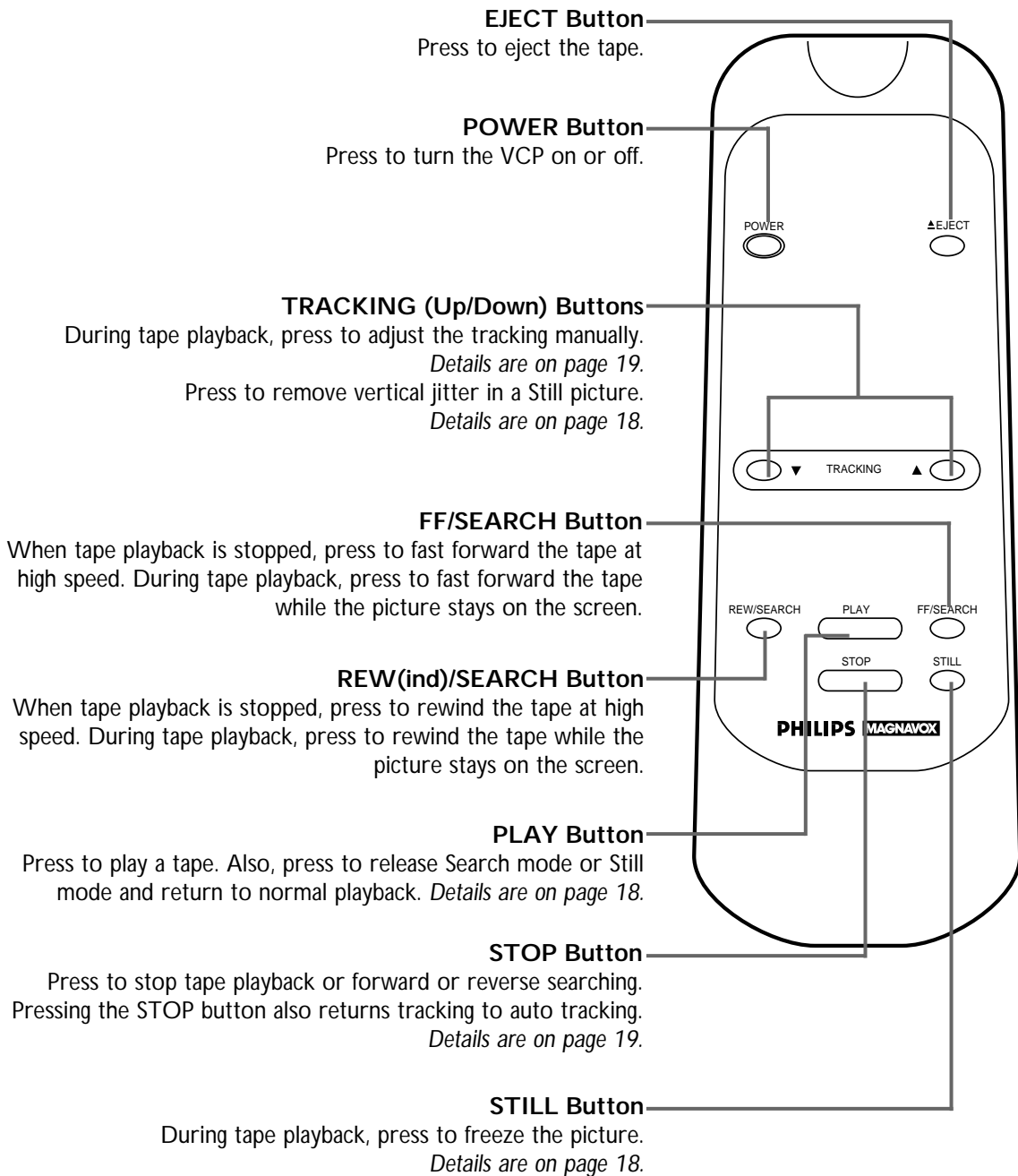

14 Front Panel

STOP/EJECT Button

Press once to stop the tape. When tape playback is stopped, press to eject the tape.

F.FWD (Fast Forward) Button

When tape playback is stopped, press to fast forward the tape at high speed. During tape playback, press to fast forward the tape while the picture stays on the screen. *Details are on page 18.*

PLAY Button

Press to play a tape. Also, press to release Search mode or Still mode and return to normal playback. *Details are on page 18.*

REW(ind) Button

When tape playback is stopped, press to rewind the tape at high speed. During tape playback, press to rewind the tape while the picture stays on the screen. *Details are on page 18.*

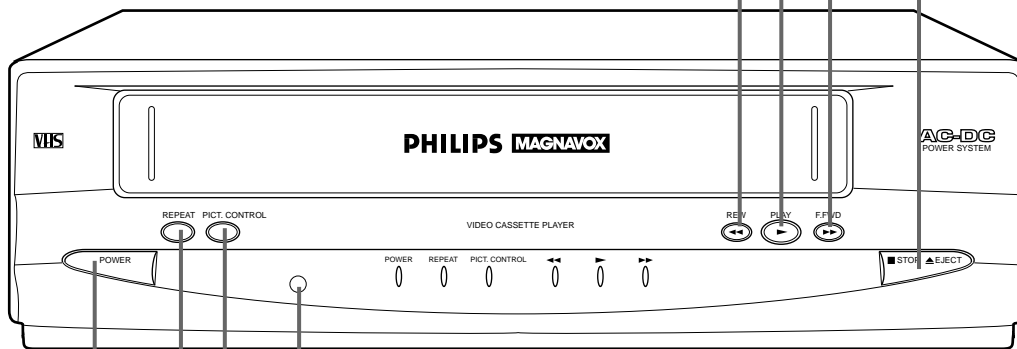

POWER Button

Press to turn the power on and off.

PICT(ure) CONTROL Button

Press to improve the playback picture quality of rental tapes. *Details are on page 17.*

REPEAT Button

Press to make the VCP play a tape over and over. Press again to cancel Repeat Playback. *Details are on page 17.*

Remote Sensor

Receives the signal from your remote control so you can operate your VCP from a distance.

AC Power Cord

Connect to a standard AC outlet to supply power to the VCP. Make sure the car battery cord is disconnected from the VCP.

CH3/CH4 Switch

Set to channel 3 or 4 to use your TV with your VCP. *Details are on pages six-nine.*

ANT(enna) OUT Jack

Use the supplied RF coaxial cable to connect this jack to the ANTENNA IN jack on your TV or Cable Box.

Details are on pages six-nine.

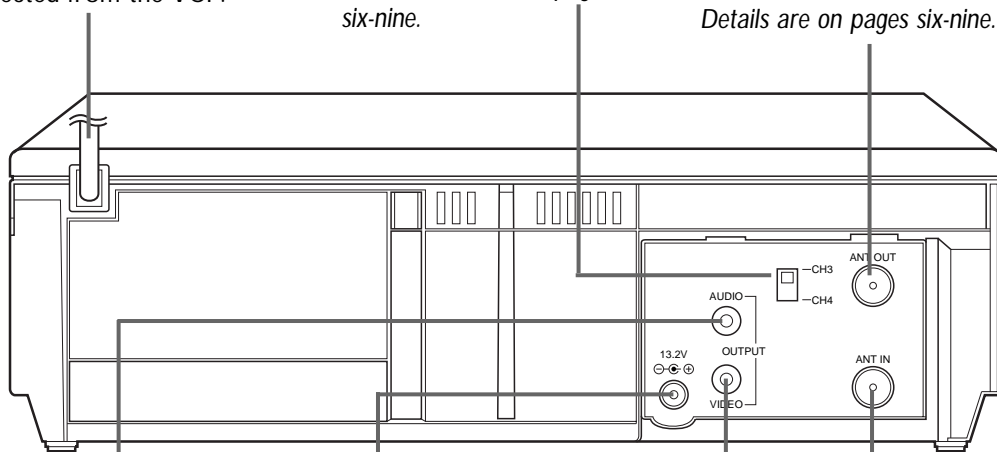

AUDIO OUTPUT Jack

Use an audio cable (not supplied) to connect this jack to the Audio In jack of a TV, camcorder, VCR, or audio system.

Details are on page 10.

VIDEO OUTPUT Jack

Use a video cable (not supplied) to connect this jack to the Video In jack of a TV, camcorder, VCR, or monitor.

Details are on page 10.

13.2V Jack

Connect the car battery cord here when you use the VCP in your vehicle.

Details are on page 11.

ANT(enna) IN Jack

Connect your antenna or cable here.

Details are on pages six-10.

16 Playing

Before playing a tape, make sure the VCP and TV are connected (see pages six-11). Then, follow the steps below.

1

Turn on the TV. Set it to the same channel as the CH3/CH4 switch on the back of the VCP.

2

Insert a tape in the VCP. The power will come on and playback will start automatically. The POWER light and the Play light will appear on the display panel of the VCP.

3

If the tape you want to play is already in the VCP, make sure the VCP power is on, then **press the PLAY button.**

4

To stop playback, press the **STOP button.**

5

Press the **REW(ind)/SEARCH button.**

6

Press the **EJECT button** to eject the tape.

1 Turn on the TV. Set it to channel 3 or 4.

2 Insert a tape in the VCP.

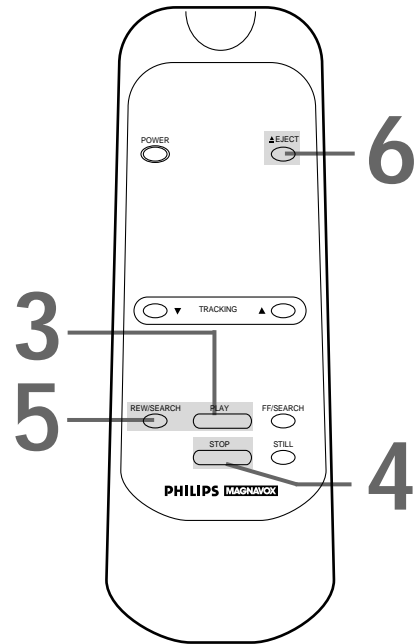

Helpful Hints

- Other playback options and features are explained on pages 17-19
- Moisture may condense inside the unit when it is moved from a cold place to a warm place, after heating a cold room, or when the humidity is high. When moisture has accumulated in your VCP, the POWER light will blink. If you try to play a tape in a VCP in which moisture has accumulated, the tape and the VCP could be damaged. If the POWER light is blinking, keep the VCP power on (but do not play a tape) for at least two hours. When the POWER light stops blinking, it is safe to play a tape.

Repeat Playback

1

During tape playback, press the **REPEAT** button on the VCP. The REPEAT light will come on. When a tape has finished playing, the VCP will rewind it and start playback again and again.

2

To cancel Repeat Playback, press the **REPEAT** button again. The REPEAT light will go off.

Picture Control

1

During tape playback, press the **PICT(ure) CONTROL** button on the VCP to improve the picture quality of tapes. The PICT(ure) CONTROL light will come on.

2

To turn off the Picture Control feature, press the **PICT(ure) CONTROL** button again. The PICT(ure) CONTROL light will go off.

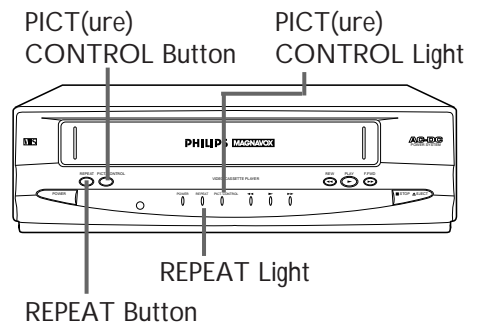

Helpful Hint

- If you press the **REPEAT** button to start Repeat Playback when playback is stopped, playback will start automatically. The Play light and the REPEAT light will appear.

18 Playback Options

Forward and Reverse Searching (SP/LP/SLP)

1

During tape playback, press and release the **FF/SEARCH** button or the **REW(ind)/SEARCH** button. A fast forward or reverse picture search will begin. (Noise bars will appear.)

2

To stop searching, press the **STOP** button. To return to playback, press the **PLAY** button.

Super High Speed Searching (LP/SLP)

1

During tape playback, press the **FF/SEARCH** button or the **REW(ind)/SEARCH** button twice. Now, the VCP will search in super high speed. (Noise bars will appear.)

2

To return to playback, press the **PLAY** button.

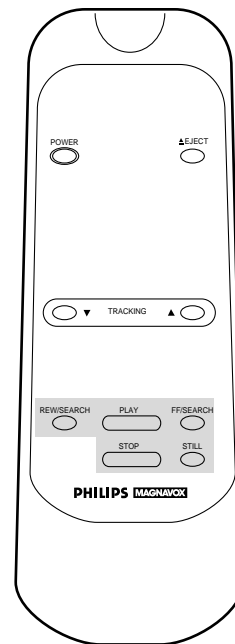

Viewing a Still Picture

1

During tape playback, press the **STILL** button. A still picture will appear on the screen.

Tapes recorded in SLP (Super Long Play) will show the clearest picture.

2

Each time you press the **STILL** button, the noise bars will change position on the screen. The tape also will advance slightly.

If a still picture vibrates vertically, stabilize it by pressing the **TRACKING** (Up/Down) buttons on the remote control.

3

To release the still picture and return to normal playback, press the **PLAY** button.

Helpful Hints

- *SP/LP/SLP means this feature will work with tapes recorded in Standard Play, Long Play, or Super Long Play.*
- *LP/SLP means this feature will work with tapes recorded in Long Play or Super Long Play. For details about tape speed, see page five.*
- *Still mode automatically switches to Stop mode after five minutes to protect the VCP and the tape from damage.*

Automatic Operation Features 19

Direct Button Operation

When a tape is in the VCP and the VCP power is off, press the PLAY, REW(ind), or F.FWD button **on the VCP**. The VCP will turn on automatically and playback, rewinding, or fast forwarding will start immediately.

Automatic Playback

When you put a tape in the VCP, the power will come on and playback will begin automatically.

Automatic Rewind, Off, Eject

When a tape is played or fast forwarded to its end, the VCP will rewind the tape, stop, turn itself off, and eject the tape. (The VCP will not operate this way if Repeat Playback is activated. *Details are on page 17.*)

Tape Eject

A tape can be ejected with the VCP power on or off (but the VCP power cord must be plugged in).

Automatic Tracking Adjustment

The VCP has automatic tracking adjustment, which gives you the best possible picture quality. With some recordings, however, you may get a better picture using the manual tracking controls (see below).

Manual Tracking

To adjust the tracking manually during tape playback, press the TRACKING (Up/Down) buttons on the remote control.

NOTE:

- Tracking is returned to automatic tracking adjustment when a tape is inserted or when the STOP button is pressed to halt playback.

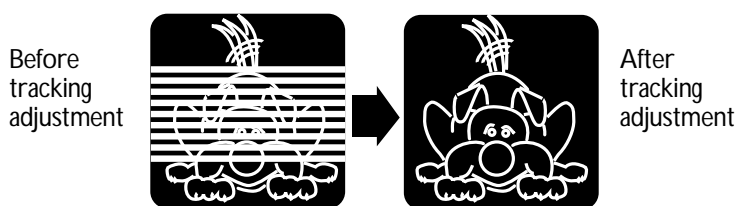

20 Helpful Hints

If you are having problems with your product, check this list of problems and possible solutions before requesting service. You may be able to solve the problem yourself.

If you need to call a customer service representative, please know the model number and serial number of your product before you call. This information is displayed on the back of the product. Also, please take a moment to identify the problem you are having, and be prepared to explain this to the representative. If you believe the representative will need to help you with operations, please stay near the product. Our representatives will be happy to assist you.

The VCP has no power.

- Make sure the AC power cord is connected completely to an AC (alternating current) outlet. If you are using AC power, make sure the car battery cord is disconnected completely.
- Make sure the car battery cord is connected completely to the vehicle's cigarette lighter socket and to the 13.2V Jack on the back of the VCP when the VCP is installed in the vehicle.
- Make sure the power is turned on.

There is no playback picture, or the playback picture is noisy and contains streaks.

- Make sure the TV is on the same channel as the VCP's CH3/CH4 switch (pages six-nine).
- Make sure channel 3 or 4 is adjusted properly.
- Adjust the tracking (page 19).
- TVs placed too close to the VCP can cause interference during tape playback. Move the VCP away from the TV.

The VCP can not be controlled with the remote control.

- Aim the remote control directly at the VCP's remote sensor (pages five and 14).
- Remove all obstacles between the remote control and the VCP.
- Inspect and/or replace the batteries in the remote control (page five).

TV programs can not be watched normally.

- Check the connections between the VCP, your TV, the Cable Box (if applicable), and the antenna/cable (pages six-10).
- Turn off the VCP power.

Tape can not be inserted.

- Insert the tape window side up, with the record tab facing you.
- Make sure a tape isn't already in the VCP by pressing the STOP/EJECT button on the VCP or the EJECT button on the remote control.
- Gently push on the center of the tape when putting it in the VCP. Never force the tape into the VCP.

Tape can not be removed.

- Make sure the AC power cord is connected completely to an AC (alternating current) outlet. If you are using AC power, make sure the car battery cord is disconnected completely.
- Make sure the car battery cord is completely connected to the vehicle's cigarette lighter socket and to the 13.2V Jack on the back of the VCP when the VCP is installed in the vehicle.

The motor (cylinder) rotates even when the VCP is in Stop mode.

- To enable the quick play mechanism, the cylinder will rotate for about five minutes. This is normal. The quick play mechanism allows the tape mechanism to switch from Stop mode to Play mode in one second.

Limited Warranty 21

VIDEO CASSETTE PLAYER

90 Days Free Labor/One Year Parts Exchange/Three Years Exchange on Video Heads
This product must be carried in for repair.

WHO IS COVERED?

You must have proof of purchase to receive warranty service. A sales receipt or other document showing that you purchased the product is considered proof of purchase.

WHAT IS COVERED?

Warranty coverage begins the day you buy your product. *For 90 days thereafter*, all parts will be repaired or replaced, and labor is free. *From 90 days to one year from the day of purchase*, all parts will be repaired or replaced, but you pay for all labor charges. *From one to three years from the day of purchase*, you pay for the replacement or repair of all parts except the video heads, and for all labor charges. *After three years from the day of purchase*, you pay for the replacement or repair of all parts, and for all labor charges.

All parts, including repaired and replaced parts, are covered only for the original warranty period. When the warranty on the product expires, the warranty on all replaced and repaired parts also expires.

WHAT IS EXCLUDED?

Your warranty does not cover:

- labor charges for installation or setup of the product, adjustment of customer controls on the product, and installation or repair of antenna systems outside of the product.
- product repair and/or part replacement because of misuse, accident, unauthorized repair or other cause not within the control of Philips Consumer Electronics Company.
- reception problems caused by signal conditions or cable or antenna systems outside the unit.
- a product that requires modification or adaptation to enable it to operate in any country other than the country for which it was designed, manufactured, approved and/or authorized, or repair of products damaged by these modifications.
- incidental or consequential damages resulting from the product. (Some states do not allow the exclusion of incidental or consequential damages, so the above exclusion may not apply to you. This includes, but is not limited to, prerecorded material, whether copyrighted or not copyrighted.)
- damage caused by the use of non-VHS tapes or tapes that have not been tested and labeled for use in two, four, six, and eight hour VHS recorders.
- a product used for commercial or institutional purposes.

WHERE IS SERVICE AVAILABLE?

Warranty service is available in all countries where the product is officially distributed by Philips Consumer Electronics Company. In countries where Philips Consumer Electronics Company does not dis-

tribute the product, the local Philips service organization will attempt to provide service (although there may be a delay if the appropriate spare parts and technical manual(s) are not readily available).

MAKE SURE YOU KEEP...

Please keep your sales receipt or other document showing proof of purchase. Attach it to this owner's manual and keep both nearby. Also keep the original box and packing material in case you need to return your product.

BEFORE REQUESTING SERVICE...

Please check your owner's manual before requesting service. Adjustments of the controls discussed there may save you a service call.

TO GET WARRANTY SERVICE IN U.S.A., PUERTO RICO OR U.S. VIRGIN ISLANDS...

Take the product to a Philips factory service center (see enclosed list) or authorized service center for repair. When the product has been repaired, you must pick up the unit at the center. Centers may keep defective parts.

(In U.S.A., Puerto Rico and U.S. Virgin Islands, all implied warranties, including implied warranties of merchantability and fitness for a particular purpose, are limited in duration to the duration of this express warranty. But, because some states do not allow limitations on how long an implied warranty may last, this limitation may not apply to you.)

TO GET WARRANTY SERVICE IN CANADA...

Please contact Philips at:

1-800-661-6162 (French Speaking)

1-800-363-7278 (English Speaking)

(In Canada, this warranty is given in lieu of all other warranties. No other warranties are expressed or implied, including any implied warranties of merchantability or fitness for a particular purpose. Philips is not liable under any circumstances for any direct, indirect, special, incidental or consequential damages, howsoever incurred, even if notified of the possibility of such damages.)

REMEMBER...

Please record below the model and serial numbers found on the product. Also, please fill out and mail your warranty registration card promptly. It will be easier for us to notify you if necessary.

MODEL # _____

SERIAL # _____

This warranty gives you specific legal rights. You may have other rights which vary from state to state.

Philips Service Solutions Group, P.O. Box 2976, Longview, Texas 75606
(903) 242-4800

EL6035E004 / MAC6108 / 12-98

22 Specifications/Glossary

Specifications

Video Heads

Two heads

Video Signal

EIA standards; NTSC color

Antenna

VHF/UHF – 75 ohm external antenna/cable terminal

VHF Output Signal

Channel 3 or 4 (switchable)
75 ohms unbalanced

Power Requirement

AC 120V \pm 10%, 60Hz \pm 5%,
DC 13.2V \pm 10%

Power Consumption

AC 12W
DC 12W

Operating Temperature

41°F (5°C) to 104°F (40°C)

Relative Humidity

10% to 80%

Weight

5.1 lbs. (2.3 kg.)

Dimensions

11"(W) x 3-5/8"(H) x 10-1/4"(D)
(280 mm x 92mm x 260mm)

NOTE: Designs and specifications are subject to change without notice.

Glossary

Antenna: VHF (very high frequency; channels 2 - 13) and UHF (ultra high frequency; channels 14 - 69).

AUDIO OUTPUT Jack: jack located on the back of the VCP which is used to send audio to another system.

Cable: all standard channels can be received without a Cable Box.

Frame: a single still picture.

Remote Control: the small electronic unit that came with your VCP; allows you to operate your VCP from a distance.

Special Effects: forward and reverse searching, viewing a still picture.

VCP: video cassette player.

VIDEO OUTPUT Jack: jack located on the back of the VCP which is used to send video to another system.

<ul style="list-style-type: none"> ac power cord15 accessories24 ant(enna) in jack15 ant(enna) out jack15 audio output jack10, 15 automatic <ul style="list-style-type: none"> playback19 rewind, off, eject19 batteries5 car battery cord11 cassette compartment13 ch3/ch4 switch7, 15 connections6-11 contents, table of4 controls <ul style="list-style-type: none"> remote12 vcp13-15 dew sensor13 direct button operation19 display panel13 eject button12 fast forward light13 f.fwd button14 ff/search button12 front panel14 glossary22 helpful hints20 hookups <ul style="list-style-type: none"> mobile11 with a cable box8-9 with a stereo tv10 without a cable box6-7 long play5, 18 lp5, 18 picture control <ul style="list-style-type: none"> button14 feature17 light13 play <ul style="list-style-type: none"> button12, 14 light13 playback <ul style="list-style-type: none"> features19 options17-18 playing16 	<ul style="list-style-type: none"> power <ul style="list-style-type: none"> button12, 14 cord15 light13 rear panel15 remote <ul style="list-style-type: none"> control <ul style="list-style-type: none"> buttons12 using5 sensor5, 14 repeat <ul style="list-style-type: none"> button14 light13 playback17 rew(ind) button14 rew(ind)/search button12 rewind light13 rf coaxial cable6-9 safety precautions3 searching17 sensor (remote)5, 14 slp5, 18 sp5, 18 standard play5, 18 stereo tv hookup10 still button12, 18 still picture18 stop button12 stop/eject button14 super high speed searching18 super long play5, 18 table of contents4 tape <ul style="list-style-type: none"> eject19 speed5 13.2v jack11, 15 tracking19 tracking (up/down) buttons12, 18-19 tv hookups6-11 vertical jitter18 video output jack10, 15 video tapes (<i>see tape</i>) warranty21
--	---

SUPPLIED ACCESSORIES

The following items are supplied with your VCP; they are provided to help you use or set up your VCP.

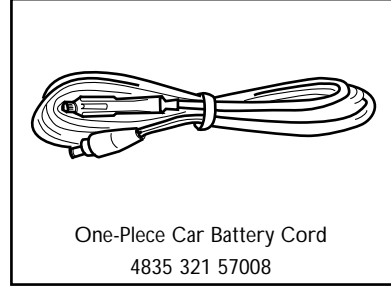
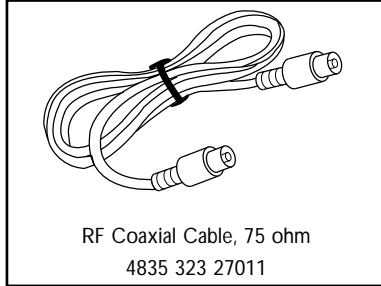
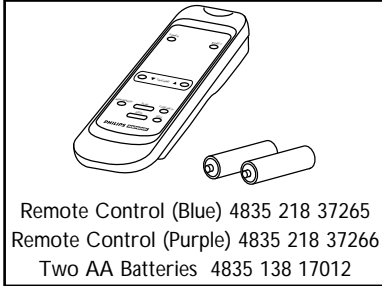

OPTIONAL ACCESSORIES

The following additional items are not provided with your VCP, but they are designed for use with your new VCP. To order these optional accessories, contact us at:

Philips Parts & Accessories Marketing Department
401 East Old Andrew Johnson Highway
P.O. Box 555
Jefferson City, TN 37760
1-800-851-8885.

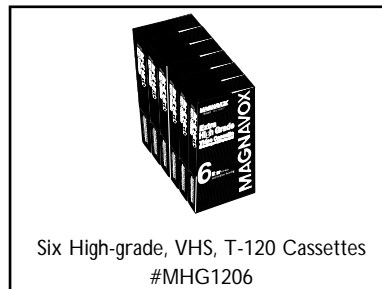
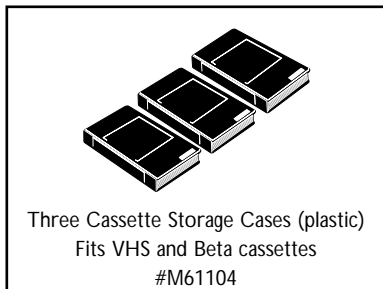
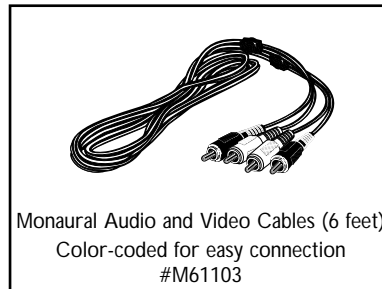

This owner's manual is made of recyclable materials.
Remember to recycle!



IB8168E001
Printed In China
OVMN02381 / H35A1UD.H35A2UD* * * * *