

WALKMAN

Radio Cassette Player

WM-FX121/FX121V/FX127/FX321/
FX321V/FX323/FX325/FQ01

Operating Instructions

WALKMAN is a registered trademark of Sony Corporation.

Sony Corporation © 1996

Printed in Malaysia

For the customers in the U.S.A.

OWNER'S RECORD

The model number is located at the rear and the serial number is located at the rear (FQ01)/inside the cassette holder (other models). Record these numbers in the spaces provided below. Refer to them whenever you call upon your Sony dealer regarding this product.

Model No. _____

Serial No. _____

Featuring

AVLS (Automatic Volume Limiter System)

The AVLS switch allows you to limit the maximum volume of your Walkman personal stereo without degrading the sound quality.

- When the AVLS switch is set to LIMIT (around 85 dB), the volume will be kept at a moderate level without the degradation of the sound quality, even if you attempt to turn the volume up higher.
- When the AVLS switch is set to LIMIT, the playback sound may be distorted or unstable according to the music (especially the bass boosted part). If this happens, turn down the volume.
- When the AVLS switch is set to NORM, you will be able to enjoy the full volume capability of your Walkman personal stereo.

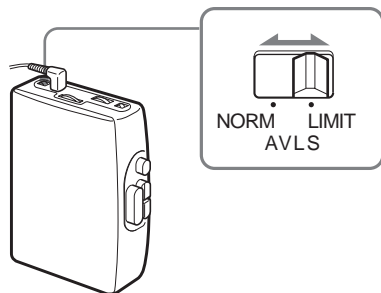

Getting Started

Using with Batteries

Insert two AA (R6) batteries in correct polarity.

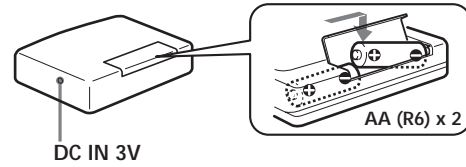

Notes

- When you are not going to use your Walkman for a long time, remove the batteries to prevent damage from battery leakage and corrosion.
- When the sound becomes unstable or cannot be heard, replace the old batteries with new ones.
- The battery life may shorten depending on the operation of the unit.

Using External Power Sources

You can connect the following external power sources through the DC IN 3 V jack located on the bottom. (When you plug a cord into the DC IN 3 V jack, the internal batteries are automatically bypassed.)

- House current using an AC-E30HG AC power adaptor

Notes

- Use only the recommended AC-E30HG AC power adaptor (not supplied). Do not use any other AC power adaptor.
- Specifications for AC-E30HG varies for each area. Check your local voltage and the shape of plug before purchasing.



Using With a Rechargeable Battery (FX127)

Before using, charge the rechargeable battery with the supplied charger.

Charging time is about 4 hours. After 4 hours, remove the batteries.

Open the battery compartment lid and insert the rechargeable battery after charging.

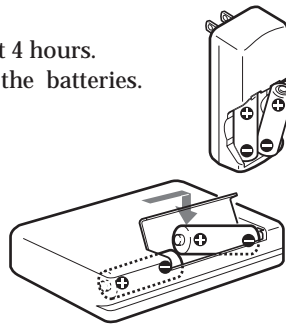

Notes

- The name plate indicating operating voltage, power consumption, etc. is located on the bottom exterior of the charger.
- The battery may become warm during charging.
- Use only the rechargeable battery NC-AA (WM) with the supplied battery charger.
- If the rechargeable battery is new or it has not been used for a long time, it may not be charged completely. (The playing time is shorter.)
- The rechargeable batteries can be charged about 300 times.

When using headphones/earphones

Wear the "L" marked side to the left ear and the "R" marked side to the right ear.

Playing Cassettes

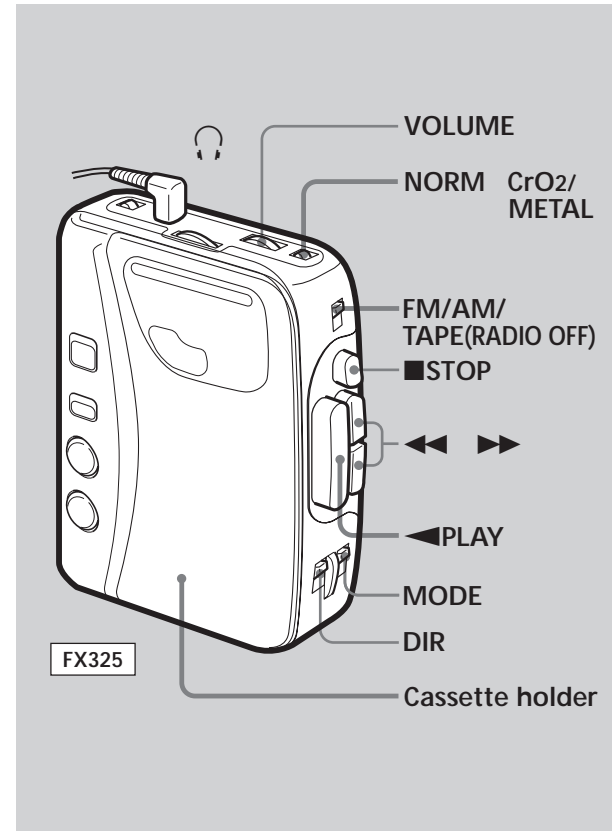

Operating the Cassette Player

To wind the tape	Press ◀◀ or ▶▶.
To change sides*	Set the DIR switch.
To play both sides once*	Set MODE to ↶.
To play both sides repeatedly*	Set MODE to ↷.
To adjust the volume	Turn the VOLUME control.
To stop	Press ■ STOP.

* except for FX121/FX121V/FX127

Notes on playing cassettes

- Do not use cassettes longer than 90 minutes except for long continuous playback.
- If the tape is playing but no sound comes out, the batteries may be weak. Replace all dry batteries with new ones or recharge all rechargeable batteries.
- If your Walkman has not been used for a long time, run the Walkman for a few minutes before inserting a cassette.
- Do not wind the headphones cord around the Walkman. The buttons may be kept pressed, causing unnecessary battery usage.
- Do not open the cassette holder while the tape is running.

Using MEGA BASS (FX323/FX325)

Set the MEGA BASS switch to ON to produce deep and powerful sound. Turn the HIGH and LOW controls to get the desired tone (FX325).

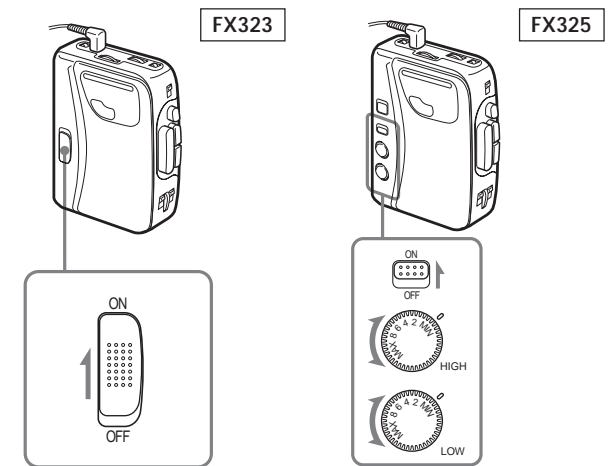

When using MEGA BASS

If the AVLS switch is set to LIMIT, the MEGA BASS effect is reduced.

Using DOLBY NR (FX325)

Set the DOLBY NR switch to ON to play Dolby NR processed tapes.

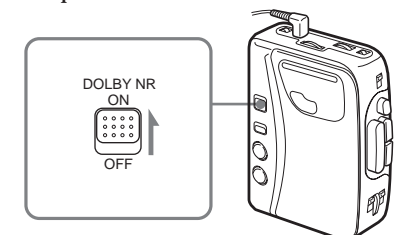

1 Insert a cassette.

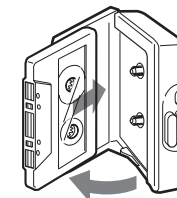

2 Set the FM/AM/TAPE (RADIO OFF) selector to TAPE (RADIO OFF).

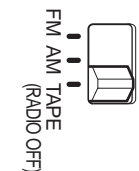

3 Select NORM or CrO2/METAL mode to match the tape type.



4 Press ◀ PLAY.



Listening to the Radio

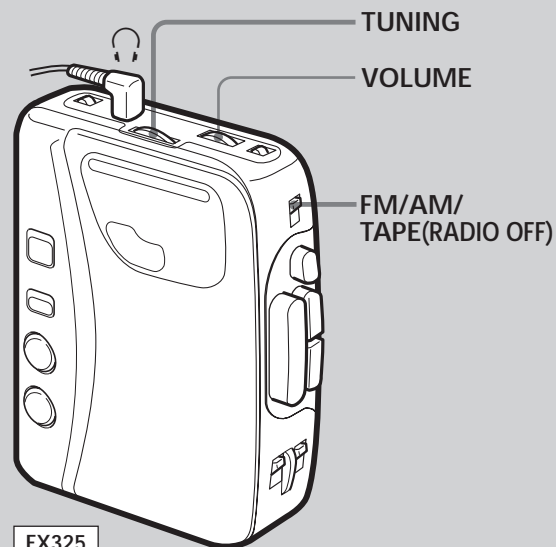

FX325

1 Set the FM/AM/TAPE (RADIO OFF) selector to AM or FM.

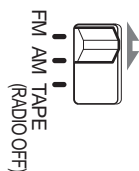

2 Tune in the desired station.



To adjust the volume	Turn the VOLUME control.
To tune off	Set the FM/AM/TAPE selector to TAPE (RADIO OFF).

Note

If you have inserted a cassette with a metallic shell or label and radio reception interference occurs, remove the cassette.

Improving Radio Reception

Improving FM reception

Extend the headphones/earphones cord or adjust the DX/LOCAL or ST/MONO switch.

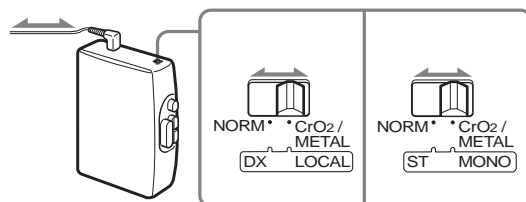

Improving AM reception

Rotate the Walkman.

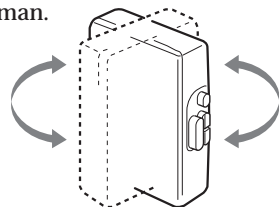

Specifications

Radio Frequency

FM: 87.6 - 108 MHz
AM: 530 - 1,710 kHz

Power Requirements

3 V DC Batteries AA (R6) x 2
External DC 3 V power sources

Battery Life

(approximate hours when using the batteries specified below) (EIAJ*)

Battery	Playback	Radio
Sony Alkaline LR6 (SG)	16 hours	48 hours
Sony R6P (SR)	4.5 hours	16 hours
Rechargeable battery** NC-AA (WM) (Full charge)	3.5 hours	12 hours

* Measured value by the standard of EIAJ (Electronic Industries Association of Japan). (Using a Sony HF series cassette tape)

** FX127 only

Dimensions

118.8 x 89.5 x 34.1 mm (4 3/4 x 3 5/8 x 1 3/8 in.)
(w/h/d) incl. projecting parts

Mass FX121/FX121V/FX127: 200g (7.1 oz) incl. batteries
FX321/FX321V/FX323/FQ01: 205g (7.3 oz) incl. batteries
FX325: 215g (7.6 oz) incl. batteries

Supplied Accessories

- Stereo headphones or stereo earphones (1)
- Belt clip (1)
- Protector (1) (FQ01)
- Rechargeable battery (2) (FX127)
- Battery charger (1) (FX127)

Optional Accessories

- AC power adaptor AC-E30HG

Your dealer may not handle some of the above listed accessories. Please ask the dealer for detailed information.

Design and specifications are subject to change without notice.

Dolby noise reduction manufactured under license from Dolby Laboratories Licensing Corporation. "DOLBY" and the double-D symbol are trademarks of Dolby Laboratories Licensing Corporation.

Precautions

Notes on Headphones/Earphones

Concerning road safety

Do not use headphones/earphones while driving, cycling, or operating any motorized vehicle. It may create a traffic hazard and is illegal in many areas. It can also be potentially dangerous to play your headphones/earphones at high volume while walking, especially at pedestrian crossings. You should exercise extreme caution or discontinue use in potentially hazardous situations.

Preventing hearing damage

Do not use headphones/earphones at high volume. Hearing experts advise against continuous, loud and extended play. If you experience a ringing in your ears, reduce volume or discontinue use.

Caring for others

Keep the volume at a moderate level. This will allow you to hear outside sounds and to be considerate to the people around you.

Taking Care of Your Walkman

- Do not expose the Walkman to extreme temperatures, direct sunlight, moisture, sand, dust or mechanical shock. Never leave the Walkman in a car parked in the sun.
- Prolonged use may contaminate the tape head. If sound drop-out or excessive noise occurs, clean the head and tape path with alcohol.

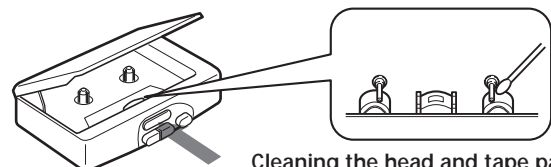

Cleaning the head and tape path

FX321/FX321V/FX323/FX325/FQ01

- Clean the headphones/earphones plug periodically for optimum sound.
- Do not use alcohol, benzine or thinner to clean the case.

About the Battery Compartment Lid

If the battery compartment lid is detached by an accidental drop, excessive force, etc., attach it as illustrated in the numbered order.

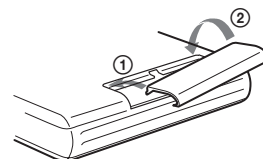

If you have any question or problem concerning your Walkman, please consult your nearest Sony dealer.

Using the Belt Clip

With the supplied belt clip, you can wear your Walkman on a belt for convenient use.

Removing the belt clip

Attaching the belt clip

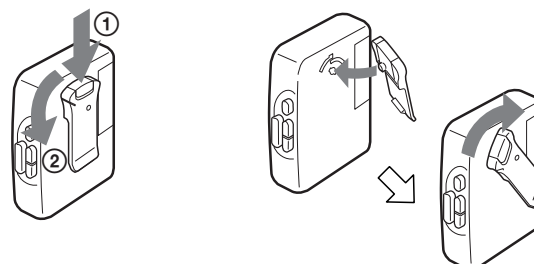

Using the protector (FQ01)

Removing the protector

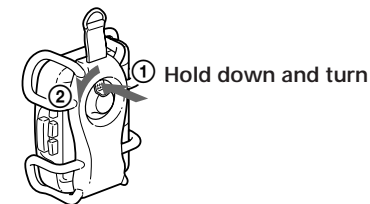

Attaching the protector

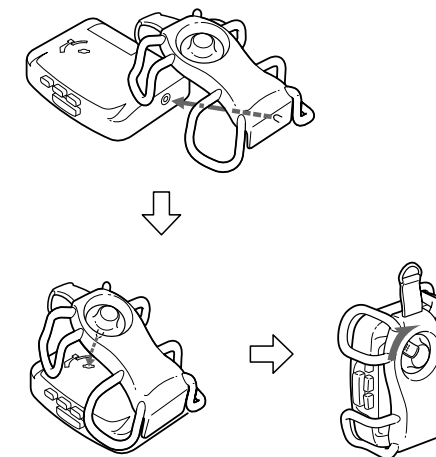

This warranty is valid only in the United States.

LIMITED WARRANTY