

# Broadband ADSL2+ Modem

Model DM111Pv2

Setup Manual



## NETGEAR®

NETGEAR, Inc.  
350 East Plumeria Drive  
San Jose, CA 95134 USA

October 2014  
208-10256-02  
v1.0

## Support

Thank you for selecting NETGEAR products.

After installing your device, locate the serial number on the label of your product and use it to register your product at <https://my.netgear.com>. You must register your product before you can use NETGEAR telephone support. NETGEAR recommends registering your product through the NETGEAR website. For product updates and web support, visit <http://support.netgear.com>.

Phone (US & Canada only): 1-888-NETGEAR.

Phone (Other Countries): Check the list of phone numbers at <http://support.netgear.com/general/contact/default.aspx>.

## Trademarks

NETGEAR, the NETGEAR logo, and Connect with Innovation are trademarks and/or registered trademarks of NETGEAR, and/or its subsidiaries in the United States and/or other countries. Information is subject to change without notice. © NETGEAR, Inc. All rights reserved.

## Compliance

For regulatory compliance information, visit <http://www.netgear.com/about/regulatory/>.

See the regulatory compliance document before connecting the power supply.

# Contents

## Broadband ADSL2+ Modem

### Setup Manual

<b>Connecting the Modem to the Internet</b> .....	1
What's in the Box? .....	1
The Bottom Label .....	1
The Front Panel .....	2
The Rear Panel .....	4
What You Need Before You Begin .....	4
Internet Configuration Requirements .....	5
Installation Requirements .....	5
Two Setup Methods: 1) Smart Wizard Setup 2) Manual Setup .....	6
Smart Wizard Setup .....	6
Manual Setup .....	7
Understanding ADSL Microfilters .....	7
Computers Set to DHCP .....	8
Manually Setting Up Your Modem .....	8
<b>Troubleshooting</b> .....	13
Basic Functioning .....	13
Power LED Not On .....	14
Power LED Never Turns Green .....	14
ADSL LED not On or Blinking .....	14
LAN or Internet Port LEDs Not On .....	15
Troubleshooting the Web Management Interface .....	16
Troubleshooting the Internet Connection .....	17
Troubleshooting PPPoE or PPPoA .....	18
Troubleshooting Internet Browsing .....	18
Restoring the Default Configuration and Password .....	19
Using the Reset Button .....	19

**Technical Specifications** ..... 20  
    General Specifications ..... 20  
**Related Documents**..... 22

# Connecting the Modem to the Internet

This chapter describes how to set up the modem on your Local Area Network (LAN) and connect to the Internet. It describes how to set up your modem for Internet access and configure basic wireless connectivity.

## What's in the Box?

The product package should contain the following items:

- modem
- AC power adapter (varies by region)
- Category 5 (Cat 5) Ethernet cable
- Telephone cable with RJ-11 connector
- Microfilters (quantity and type vary by region)
- *Resource CD*, including:
  - The Smart Wizard Installation Assistant
  - This manual
- Warranty and Support Information cards

If any of the parts are incorrect, missing, or damaged, contact your NETGEAR dealer. Keep the carton, including the original packing materials, in case you need to return the product for repair.

## The Bottom Label

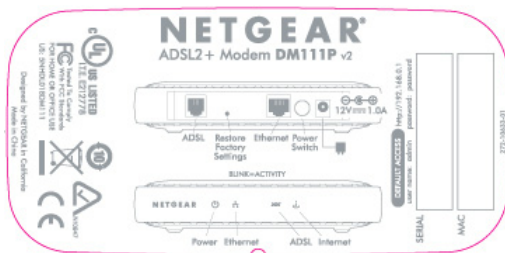

Figure 1

## The Front Panel

The modem front panel shown below contains status LEDs.

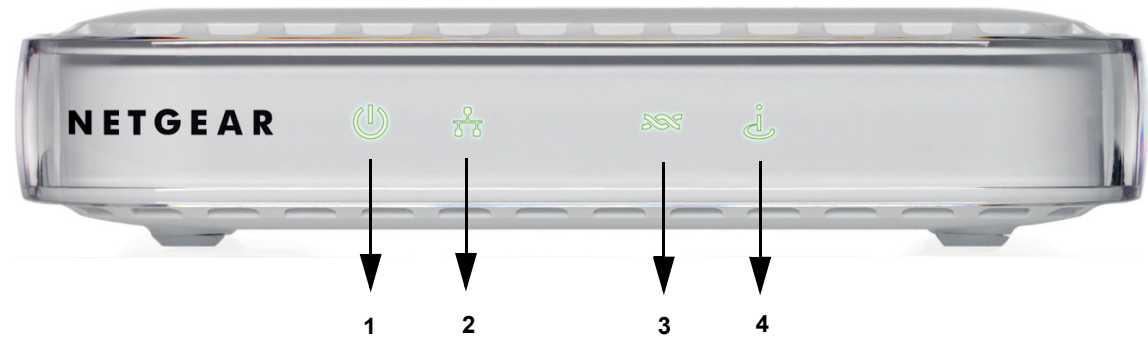

Figure 2

You can use the LEDs to verify various conditions. [Table 1](#) describes each LED.

Table 1. LED Descriptions

Label	Activity	Description
1) Power	Solid Green	Power on.
	Off	Power off.
	Red	POST (Power On Self Test), failure (not bootable), or device malfunction.
	Blink (Red)	Firmware upgrade in progress.
	Factory Reset	Lights red momentarily while the reset button is depressed, then blinks red three times when the reset button is released, then turns green, and finally the modem resets to factory defaults.
2) Ethernet	Solid Green	Powered device connected to the associated port. The LAN port is operating.
	Blink (Green)	Data is being transmitted or received.
	Off	No link is detected on this port. Modem power off, no cable or no powered device connected to the associated port.

**Table 1. LED Descriptions (continued)**

<b>Label</b>	<b>Activity</b>	<b>Description</b>
<b>3) ADSL</b>	Solid Green	The ADSL port is synchronized with the DSLAM.
	Blink (Green)	The ADSL port is in the process of synchronizing with the DSLAM. Note: Per TR-068: Blink at 2 Hz with a 50% duty cycle when trying to detect carrier signal, blink at 4 Hz with a 50% duty cycle when the carrier has been detected and the modem is trying to train.
	Off	No link is detected on the ADSL port or the modem is powered off.
<b>4) Internet</b>	Solid Green	IP is connected. The device has a WAN IP address from IPCP or DHCP and ADSL is up or a static IP address is configured, PPP negotiation—if used—has successfully completed, and no traffic detected.  If the IP or PPPoE session is dropped due to an idle time-out, the light will remain green if an ADSL connection is still present. If the session is dropped for any other reason, the light is turned off. The light will turn red when it attempts to reconnect and the DHCP or PPPoE fails (see below).
	Off	Modem power off, modem in bridged mode, or ADSL connection not present.
	Blink (Green)	IP is connected and IP traffic is passing through the device in either direction.
	Red	Device attempted to become IP connected and failed (no DHCP response, no PPPoE response, PPPoE authentication failed, no IP address from IPCP, and so on.)  For bridged mode, the indicator light must be off.

## The Rear Panel

The rear panel of the modem contains port connections.

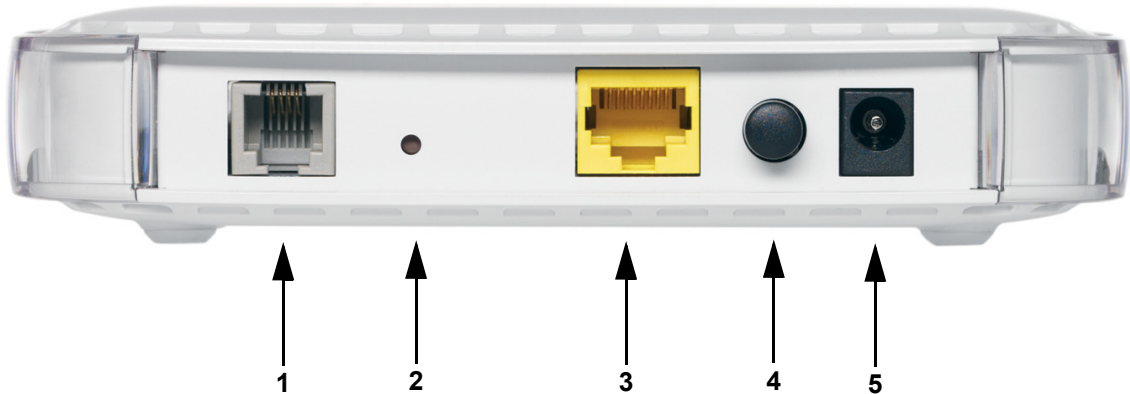

**Figure 3**

Viewed from left to right, the rear panel contains the following elements:

1. RJ-11 ADSL port for connecting the modem to an ADSL line
2. Factory Default Reset push button
3. Local Ethernet RJ-45 LAN port for connecting the local computer
4. Power switch
5. AC power adapter outlet

## What You Need Before You Begin

You need to prepare the following before you can set up your modem:

- Active Internet service provided by an ADSL account.
- The Internet Service Provider (ISP) configuration information for your ADSL account.
- ADSL microfilters as explained below.
- Your computers set to DHCP.



## Internet Configuration Requirements

Depending on how your ISP set up your Internet account, you need one or more of these configuration parameters to connect your modem to the Internet:

- Virtual Path Identifier (VPI)/Virtual Channel Identifier (VCI) parameters
- Multiplexing Method
- Host and Domain Names
- ISP Login Name and Password
- ISP Domain Name Server (DNS) Addresses
- Fixed or Static IP Address

Your ISP should have provided you with all the information needed to connect to the Internet. If you cannot locate this information, you can ask your ISP to provide it.

## Installation Requirements

Before installation, please have your DSL log in user name and password available. If not available, please obtain them from your ISP at the numbers below and IMMEDIATELY FOLLOW NETGEAR INSTALLATION PROCEDURES located in the Smart Wizard installation CD.

- For Earthlink customers, please call 1-800-EARTHLINK.
- For AT&T customers, please call 1-877-722-3755.
- For Qwest customers, please call 1-877-348-9005.
- For Verizon customers, please call 1-800-567-6789.

NETGEAR modem and gateway products are designed to be compatible with major ISPs in North America including Earthlink, AT&T, Qwest, and Verizon. For any NETGEAR product installation support and compatibility concerns, please call NETGEAR at 1-888-NETGEAR, as ISP support for NETGEAR products may be limited. Please only call your ISP to obtain log in user name and password.

# Two Setup Methods: 1) Smart Wizard Setup 2) Manual Setup

You have two methods available for setting up your modem:

- **Smart Wizard Setup:** Use the Smart Wizard on the CD to assist you with setting up your modem.
  - This option is the easiest. The Smart Wizard on the CD guides you through the setup process, automating many of the steps, and verifying that necessary conditions exist and that steps you perform have been successfully completed.
  - This option requires a PC running Microsoft Windows 98SE or higher.
- **Manual Setup:** Manually set up your modem.
  - This option is best if you are replacing an existing modem or are technically knowledgeable.
  - Use this option if you are using a computer that does not run Microsoft Windows.
  - The manual setup procedures are documented in this manual.

Use the setup option that best suites you.

## Smart Wizard Setup

The Smart Wizard setup process should take about 20 minutes to complete.

1. Locate the ADSL settings information your Internet service provider gave you.
2. Insert the NETGEAR CD into a Windows PC.

The CD will automatically start and detect the language you are using on your PC.



If the CD does not automatically start, browse the CD and double-click on Autorun.

3. Accept the language option or change to a different language.
4. Click Next to proceed.
5. Click Setup to start the Smart Wizard installation assistant. Follow the instructions on the screen.

# Manual Setup

Use the topics and procedures below to manually set up your modem.

## Understanding ADSL Microfilters

ADSL technology uses the same wires as your telephone service. However, ADSL adds signals to the telephone lines which create noise in the telephone service. You must use ADSL microfilters to filter out these signals before they reach your telephone.



If you purchased the modem in a country where a microfilter is not included, you must acquire one.

### ADSL Microfilter

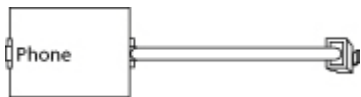

Figure 4

Each device such as a telephone, fax machine, answering machine, or caller ID display will require an ADSL microfilter.



Do not connect the modem to the ADSL line through a microfilter unless the microfilter is a combination microfilter/splitter specifically designed for this purpose. Doing so will prevent block your connection to the Internet. If you have any doubts about this, connect the modem directly to the ADSL line.

### ADSL Microfilter with Built-In Splitter

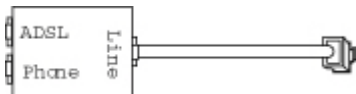

Figure 5

Use an ADSL microfilter with built-in splitter when there is a single wall outlet which must provide connectivity for both the modem and telephone equipment.

## Computers Set to DHCP

For the initial connection to your modem, your computer has to be set to automatically get its TCP/IP configuration from the modem via DHCP. This is usually the case. The NETGEAR Smart Wizard CD automatically takes care of this requirement. For manual setup, refer to the documentation that came with your computer.

## Manually Setting Up Your Modem

There are four steps to setting up your modem:

1. Install ADSL filters on the phone lines.
2. Connect the modem to the ADSL line.
3. Log in to the modem.
4. Connect to the Internet.

Follow the steps below to connect your modem to your network. Before you begin, locate the ADSL configuration information from your Internet Service Provider (ISP).

1. Connect the ADSL filter.



If you purchased the modem in a country where an ADSL filter is not included, you must acquire one.

- a. You need to install an ADSL filter for every telephone that uses the same phone line as your modem. Select the filter that came with your modem.

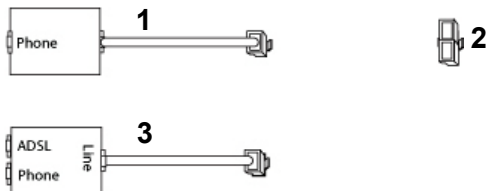

1. One-Line Filter: Use with a phone or fax machine.
2. Splitter: Use with a one-line filter to share an outlet with a phone and the modem.
3. Two-Line Filter with Splitter: Use to share an outlet with a phone and the modem.

**Figure 6**

- b. **Two-Line Filter Example.** Insert the two-line filter into the phone outlet and connect the phone to the phone line connector (A):

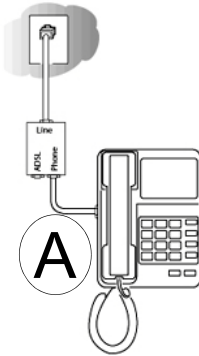
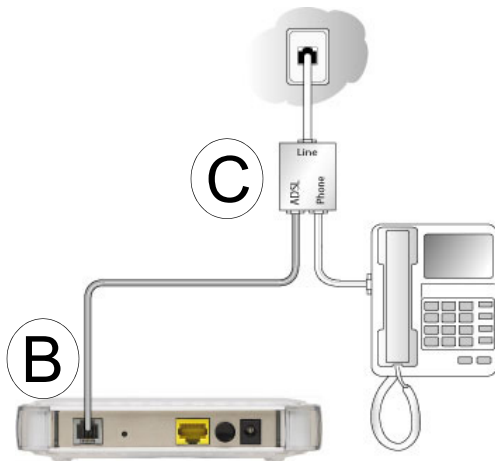

**Figure 7**



To use a one-line filter with a separate splitter, insert the splitter into the phone outlet, connect the one-line filter to the splitter, and connect the phone to the filter.

2. Connect the modem to the ADSL filter.
- a. Using the included phone cable with RJ-11 jacks, connect the ADSL port (B) of the modem to the ADSL port (C) of the two-line filter.

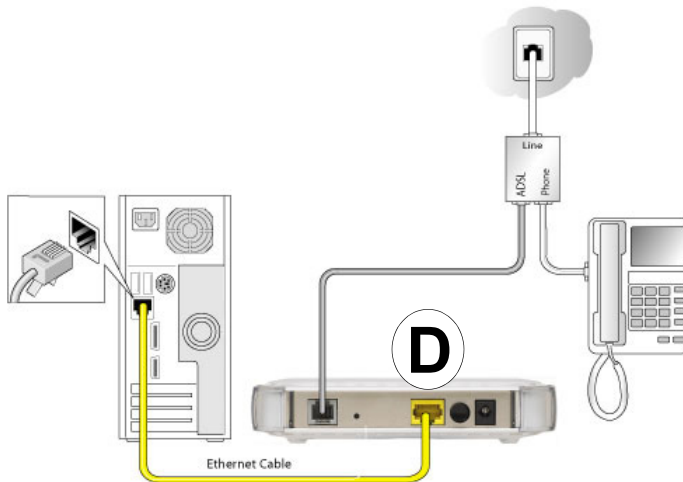

**Figure 8**



Improperly connecting a filter to your modem will block your ADSL connection.

- b. Connect the Ethernet cable from the modem LAN port (**D**) to the Ethernet adapter in your computer.



**Figure 9**

- c. Now, turn on your computer. If software usually logs you in to your Internet connection, do not run that software. Cancel it if it starts automatically.
- d. Connect the power adapter to the modem and plug it in to a power outlet. Verify the following (see [Figure 10 on page 11](#)):
  1. The power light is lit after turning on the modem.
  2. The Ethernet light is on.
  3. The ADSL light is green, indicating you are connected to the ADSL network.



**Figure 10**

3. Log in to the modem.



Your computer needs to be configured for DHCP. For instructions on configuring for DHCP, please see the documentation that came with your computer or the online document that you can access from [“Preparing Your Network”](#) on page 22.

- a. Type **http://192.168.0.1** in the address field of a browser such as Internet Explorer.



**Figure 11**

This login window opens:

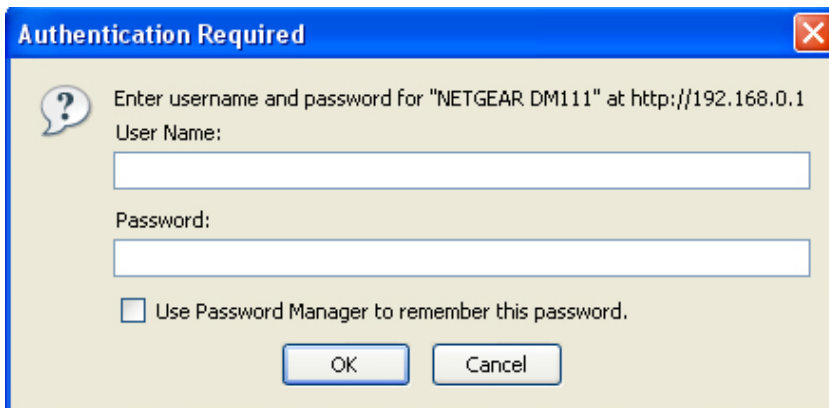

**Figure 12**

- b. Enter **admin** for the user name and **password** for the password, both in lower case letters.

After logging in, the Setup Wizard screen displays.



**Figure 13**

#### 4. Connect to the Internet

You are now ready to configure your modem to connect to the Internet. There are two ways you can configure your modem to connect to the Internet:

- a. Let the modem Setup Wizard auto-detect the type of Internet connection you have and configure it.
- b. Manually choose which type of Internet connection you have and configure it.

In either case, use the configuration parameters your ISP provided to assure that the configuration settings for your Internet connection are correct.

#### 5. Test your Internet connection.

From the bottom of the Setup menu, click Test. If the NETGEAR Web site does not appear within one minute, go to [“Troubleshooting” on page 13](#).

Your modem is now configured to provide Internet access for your network. Your modem automatically connects to the Internet when one of your computers requires access. It is not necessary to run a dialer or login application such as Dial-Up Networking or Ethernet to connect, log in, or disconnect. These functions are performed automatically by the modem as needed.

To access the Internet from any computer connected to your modem, launch a browser such as Microsoft Internet Explorer. You should see the modem’s Internet LED blink, indicating communication to the ISP. The browser should begin to display a Web page.



# Troubleshooting

This chapter gives information about troubleshooting your Broadband ADSL2+ Modem DM111Pv2. After each problem description, instructions are provided to help you diagnose and solve the problem. For the common problems listed, go to the section indicated.

- Is the modem on?  
Go to [“Basic Functioning”](#).
- Have I connected the modem correctly?  
Go to [“Basic Functioning”](#).
- I cannot access the modem’s configuration with my browser.  
Go to [“Troubleshooting the Web Management Interface”](#) on page 16.
- I have configured the modem but I cannot access the Internet.  
Go to [“Troubleshooting the Internet Connection”](#) on page 17.
- I cannot remember the modem’s configuration password.  
Go to [“Using the Reset Button”](#) on page 19.
- I want to clear the modem configuration and start over again.  
Go to [“Restoring the Default Configuration and Password”](#) on page 19.

## Basic Functioning

After you turn on power to the modem, the following sequence of events should occur:

1. When power is first applied, verify that the Power LED initially displays red to indicate that the self-test procedure is running (see [“The Front Panel”](#) on page 2 for an illustration and explanation of the LEDs).
2. After approximately 10 seconds, verify that:
  - a. The Power LED changes color from red to green.
  - b. The LAN port LED is lit to indicate that the modem is connected to your PC or router.

- c. The ADSL port LED is lit, indicating that your modem is synchronized to your ISP's DSLAM.
- d. The Internet LED is lit to indicate that you have an Internet connection.

If any of these conditions does not occur, refer to the appropriate following section.

## Power LED Not On

If the Power and other LEDs are off when your modem is turned on:

- Make sure that the power cord is properly connected to your modem and that the power supply adapter is properly connected to a functioning power outlet, and the power switch on the back of the modem is pressed in.
- Check that you are using the 12 V DC power adapter supplied by NETGEAR for this product.

If the error persists, you have a hardware problem and should contact technical support.

## Power LED Never Turns Green

If the Power LED never turns green, the modem's self-test procedure failed.

- Cycle the power to see if the modem recovers.
- Clear the modem's configuration to factory defaults. This will set the modem's IP address to 192.168.0.1. This procedure is explained in [“Using the Reset Button” on page 19](#).

If the error persists, you might have a hardware problem and should contact technical support.

## ADSL LED not On or Blinking

If the ADSL LED is not lit, no ADSL link is detected. Check the following:

- Make sure that the telephone jack is live—temporarily connect a standard telephone to the telephone jack to check for a dial tone.
- Make sure that the telephone cable connections are secure at the modem and at the ADSL-capable telephone jack.

If the ADSL LED is on, but is continuously blinking, the modem cannot synchronize with your ISP's equipment.

If you have just installed the modem and the ADSL LED has never been solid on, check the following:

- Disconnect all telephones on the line. If this solves the problem, reconnect the telephones one at a time, being careful to use a microfilter on each telephone. If the microfilters are connected correctly, you should be able to connect all your telephones.
- If disconnecting telephones does not result in a green Internet LED, there may be a problem with your wiring. If the telephone company has tested the ADSL signal at your Network Interface Device (NID), then you may have poor quality wiring in your house.
- Verify that you are connected to the correct telephone line. If you have more than one phone line, be sure that you are connected to the line with the ADSL service. It may be necessary to use a swapper if your ADSL signal is on pins 1 and 4 or the RJ-11 jack. The modem uses pins 2 and 3.
- Log in to the modem interface and select **ADSL Settings** from the Setup section of the main menu.
- Make sure your login name and account password are correct and the ADSL settings are set to the values required by your ISP.

If the ADSL light was solid on but is now blinking, try switching off the modem, waiting 30 seconds, and then switching back on again to see if the modem recovers. If the problem persists, try the following:

- Check with your ISP that your service is not being interrupted.
- If you have recently installed a telephone or other device that uses the telephone lines, make sure that it is connected to the telephone line via a microfilter.
- Log in to the modem interface, note the modem and ADSL status, run the diagnostics test, and contact your ISP's technical support representative. See the *User Manual* for detailed information.

## **LAN or Internet Port LEDs Not On**

If either the LAN LED or Internet LED does not light when the Ethernet connection is made, check the following:

- Make sure that the Ethernet cable connections are secure at the modem and at the connected router or computer.
- Make sure that power is turned on to the connected router or computer.

- If the LAN port is lit, but the Internet port is not, log in to the modem interface, note the modem and ADSL status, run the diagnostics test, and contact your ISP's technical support representative. See the *User Manual* for detailed information.

## Troubleshooting the Web Management Interface

If you are unable to access the modem's Web Management interface from your computer check the following:

- Check the Ethernet connection between the computer and the modem as described in the previous section.
- If your computer is directly connected to the modem, make sure your computer's IP address is on the same subnet as the modem. If you are using the recommended addressing scheme, your computer's address should be in the range of 192.168.0.2 to 192.168.0.254. Follow the instructions in the online document that you can access from "[Preparing Your Network](#)" on [page 22](#) to configure your computer.



If your computer's IP address is shown as 169.254.x.x:

Recent versions of Windows and MacOS will generate and assign an IP address if the computer cannot reach a DHCP server. These auto-generated addresses are in the range of 169.254.x.x. If your IP address is in this range, check the connection from the computer to the modem and reboot your computer.

- If your modem is connected to your computer via a router, make sure the computer's IP address is on the same subnet as the router, and the router is on a *different* subnet from the modem. The LAN IP addresses of the modem and router will normally be printed on a label on the bottom or rear of the unit.
- If your modem's IP address was changed and you do not know the current IP address, clear the modem's configuration to factory defaults. This will set the modem's IP address to 192.168.0.1. This procedure is explained in "[Using the Reset Button](#)" on [page 19](#).
- Make sure your browser has Java, JavaScript, or ActiveX enabled. If you are using Internet Explorer, click **Refresh** to be sure that the Java applet is loaded.
- Try quitting the browser and launching it again.
- Make sure you are using the correct login information. The factory default login name is **admin** and the password is **password**. Make sure that CAPS LOCK is off when entering this information.

If the modem does not save changes you have made in the Web Management Interface, check the following:

- When entering configuration settings, be sure to click the **Apply** button before moving to another menu or tab, or your changes are lost.
- Click the **Refresh** or **Reload** button in the Web browser. The changes may have occurred, but the Web browser may be caching the old configuration.

## Troubleshooting the Internet Connection

If your computer is connected to your modem via a router, disconnect the router and directly connect the computer to the modem. If you now have Internet access, use the documentation that came with the router to perform re-installation and troubleshooting.

If your modem is unable to access the internet, but your Internet LED is green or blinking green, you should determine whether the modem is able to obtain an IP address from the ISP. Unless you have been assigned a static IP address, your modem must request an IP address from the ISP. You can determine whether the request was successful using the browser interface.

To check the WAN IP address from the browser interface:

1. Launch your browser and select an external site such as [www.netgear.com](http://www.netgear.com).
2. Access the management interface of the modem using your browser. For details, see “[Log in to the modem.](#)” on page 11.
3. Under the Maintenance heading, select **Modem Status**. Check that an IP address is shown for the ADSL Port. If 0.0.0.0 is shown, your modem has not obtained an IP address from your ISP.

If your modem is unable to obtain an IP address from the ISP, the problem may be one of the following:

- Your ISP may require a Multiplexing Method or Virtual Path Identifier/Virtual Channel Identifier parameter.

Verify with your ISP the Multiplexing Method and parameter value, and update the router’s ADSL settings accordingly.

- If your ISP requires PPP over Ethernet (PPPoE) or PPP over ATM (PPPOA), check that your login credentials are correct. See “[Troubleshooting PPPoE or PPPoA](#)” on page 18.
- Log in to the modem interface, note the modem and ADSL status, run the diagnostics test, and contact your ISP’s technical support representative. See the *User Manual* for detailed information.

## Troubleshooting PPPoE or PPPoA

The PPPoA or PPPoA connection can be debugged as follows:

1. Access the Main Menu of the modem at **http://192.168.0.1**.
2. Under the Maintenance heading, select the **Diagnostics**.
3. Click **Run Diagnostic Tests**.
4. If all of the steps indicate “OK” then your PPPoE or PPPoA connection is up and working.

If you cannot connect after several minutes, you may be using an incorrect Service Name, User Name or Password. There also may be a provisioning problem with your ISP.



Unless you connect manually, the modem will not authenticate using PPPoE or PPPoA until data is transmitted to the network.

## Troubleshooting Internet Browsing

If your modem can obtain an IP address but your computer is unable to load any Web pages from the Internet:

- Your computer may not recognize any DNS server addresses.

A DNS server is a host on the Internet that translates Internet names (such as www addresses) to numeric IP addresses. Typically your ISP will provide the addresses of one or two DNS servers for your use. If you entered a DNS address during the modem’s configuration, reboot your computer and verify the DNS address as described in the online document that you can access from [“Preparing Your Network” on page 22](#). Alternatively, you can configure your computer manually with DNS addresses, as explained in your operating system documentation.

- Your computer may not have the modem configured as its TCP/IP modem.
- If your computer obtains its information from the modem by DHCP, reboot the computer and verify the modem address as described in the online document that you can access from [“Preparing Your Network” on page 22](#).

# Restoring the Default Configuration and Password

This section explains how to restore the factory default configuration settings, changing the modem's administration password to **password** and the IP address to 192.168.0.1. You can erase the current configuration and restore factory defaults in two ways:

- Use the Erase function of the Web Management Interface.
- Use the Default Reset button on the rear panel of the modem. Use this method for cases when the administration password or IP address is not known.

## Using the Reset Button

To restore the factory default configuration settings without knowing the administration password or IP address, you must use the Default Reset button on the rear panel of the modem.

1. Press and hold the default reset button until the Power LED turns red (about 10 seconds).
2. Release the Default Reset button and wait for the modem to reboot.

# Technical Specifications

This appendix provides technical specifications for the modem.

## General Specifications

<b>Network Protocol and Standards Compatibility</b>	
Data and Routing Protocols:	TCP/IP (Optional) RIP-1 (Optional) RIP-2 (Optional) DHCP (Optional) PPPoE or PPPoA RFC 1483/RFC 2684 Bridged or Routed (Optional) Ethernet RFC 1577 Classical IP over ATM (Optional)
<b>Power Adapter</b>	
North America:	120V, 60 Hz, input
UK, Australia:	240V, 50 Hz, input
Europe:	230V, 50 Hz, input
Japan:	100V, 50/60 Hz, input
All regions (output):	12 V AC @ 1.0A output, 30W maximum
<b>Physical</b>	
Dimensions:	5.8" x 3.8" x 1.4" 147 mm x 95.5 mm x 34.4 mm
Weight:	0.42 lbs 0.19 kg
<b>Environmental</b>	
Operating temperature:	0° to 40° C (32° to 104° F)
Operating humidity:	90% maximum relative humidity, noncondensing



<b>Electromagnetic Emissions</b>	
Meets requirements of:	FCC Part 15 Class B; VCCI Class B; EN 55 022 (CISPR 22), Class B
<b>Interface Specifications</b>	
Ethernet LAN:	10BASE-T or 100BASE-Tx, RJ-45
WAN:	ADSL, RJ-11, pins 2 and 3 T1.413, G.DMT, G.Lite ITU Annex A or B

## Related Documents

This appendix provides links to reference documents you can use to gain a more complete understanding of the technologies used in your NETGEAR product.

<b>Document</b>	<b>Link</b>
TCP/IP Networking Basics	<a href="http://documentation.netgear.com/reference/enu/tcpip/index.htm">http://documentation.netgear.com/reference/enu/tcpip/index.htm</a>
Preparing Your Network	<a href="http://documentation.netgear.com/reference/enu/wsdhcp/index.htm">http://documentation.netgear.com/reference/enu/wsdhcp/index.htm</a>
Virtual Private Networking Basics	<a href="http://documentation.netgear.com/reference/enu/vpn/index.htm">http://documentation.netgear.com/reference/enu/vpn/index.htm</a>
Glossary:	<a href="http://documentation.netgear.com/reference/enu/glossary/index.htm">http://documentation.netgear.com/reference/enu/glossary/index.htm</a>