

Owners Manual

TEC ELECTRONIC CASH REGISTER

MA-230-100 SERIES

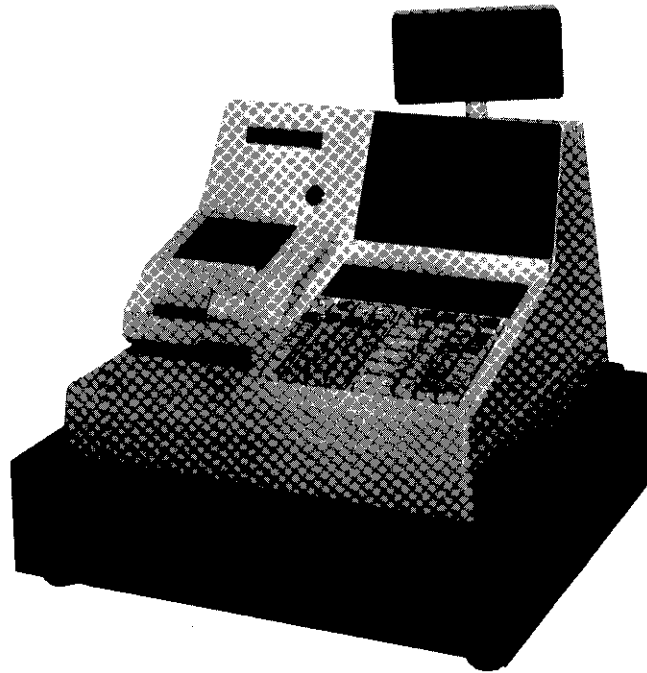

TEC TOKYO ELECTRIC CO.,LTD.

WARNING

This equipment generates, uses, and can radiate radio frequency energy and if not installed and used in accordance with the instructions manual, may cause interference to radio communications. It has been tested and found to comply with the limits for a Class A computing device pursuant to Subpart J of Part 15 of FCC Rules, which are designed to provide reasonable protection against such interference when operated in a commercial environment. Operation of this equipment in a residential area is likely to cause interference in which cause the user at his own expense will required to take whatever measures may be required to correct the interference.

TABLE OF CONTENTS

	<i>page</i>
TO OUR CUSTOMERS	1
PRECAUTIONS	1
APPEARANCE AND NOMENCLATURE	1
CONTROL LOCKS AND MODE SELECTOR KEYS	2
DISPLAY	4
KEYBOARD LAYOUT	5
FUNCTION OF EACH KEY	6
REGISTERING PROCEDURE FOR SALES	18
-- REGISTERING RECEIPT SAMPLES --	27
-- VALIDATION PRINT SAMPLES --	33
READ(X) AND RESET(Z) REPORTS	34
-- REPORT PRINT SAMPLES --	36
PAPER ROLL REPLACEMENT AND OTHER MAINTENANCE OPERATIONS	46
PAPER END DETECTION	50
WHEN A POWER FAILURE OCCURS	50
HARDWARE OPTIONS AVAILABLE	50
SPECIFICATIONS	50



TO OUR CUSTOMERS

Thank you for choosing a TEC electronic cash register MA-230-100 series. This instruction manual provides a description of the functions and handling of this register and should be read carefully to obtain maximum performance. Since every consideration has been given to safety, there is no danger of damaging the machine by incorrect operation.

Please refer to this manual whenever you have any doubts concerning the machine. This machine has been manufactured under strict quality control and should give you full satisfaction. However, if the machine is damaged during transit, or there are any unclear points in this manual, please contact your local TEC representative.

- The specifications described in this manual may be modified by TEC, if necessary.
- Be sure to keep this manual for future reference.

PRECAUTIONS

1. The keys on the keyboard work with a light touch. Avoid pressing the keys too hard.
2. Avoid handling the machine with wet hands.
3. Do not apply thinner or other volatile oils to the cabinet or other plastic parts. If dirty, wipe off with a piece of cloth soaked in neutral detergent and squeezed tightly.

APPEARANCE AND NOMENCLATURE

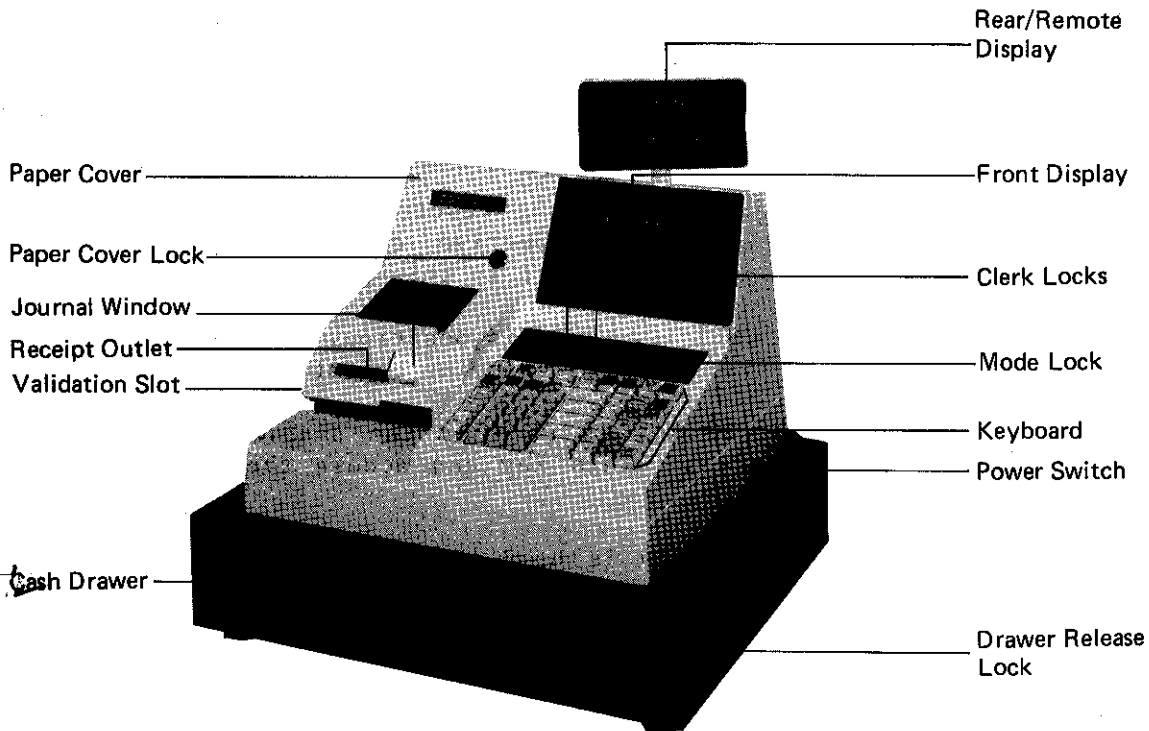

- Power Switch** ... The power switch is provided at the righthand side of the cabinet. The AC power is turned on when the switch is pushed to ON, and turned off when the switch is pushed to OFF.

CONTROL LOCKS AND MODE SELECTOR KEYS

MODE LOCK

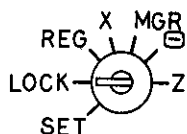

(POSITION)

(FUNCTION)

LOCK ... Displays the current time. The register operations are locked when the Mode Lock is set to this position. Paper feeding (using [RF] or [JF] key) will not be allowed, either.

REG Normal cash register operations are carried out in this mode, requiring one of the Clerk Keys to be set to ON. The operations programmed to require the "MGR" position cannot be performed in this mode.

X The sale totals can be read and the programmed data can be verified in this position.

MGR This position allows to register all normal cash register operations to be carried out in the "REG" mode and the operations programmed to require the "MGR" position. A Clerk Key is also required.

⊖ This is the "Negative Mode", which automatically processes all the entries in the reverse way, i.e., positive items into negative, and the negative items into positive. A Clerk Key is also required.

Z All resettable totals and their respective counters will be read and reset in this position.

SET In this position, the register will allow programming operations.

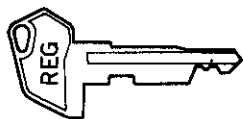

REG Key The REG Key is used by the cashier who operates the register. This key can access the positions of LOCK and REG.

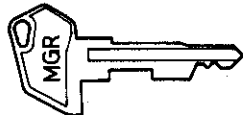

MGR Key The MGR Key is used by the store manager or a person authorized by the manager. This key can access positions of LOCK, REG, X, and MGR.

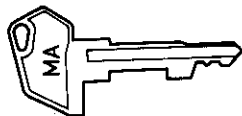

MA Key The MA Key is used by the store manager who will daily supervise the collection of money and the printout of transactions recorded by the register. This key can access the positions of LOCK, REG, X, MGR, ⊖, and Z.

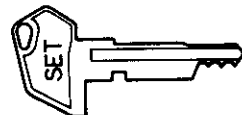

SET Key The SET Key is used by the programmer. This key can access the positions of LOCK and SET.

CLERK LOCKS (standard type)

These locks are used to identify which clerk is operating the register.

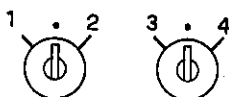

Clerk Keys (CL1, CL2, CL3, CL4)

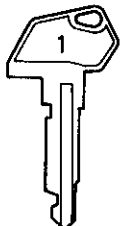

Each clerk should keep his/her clerk key. The register will not operate in the REG, MGR, or mode unless one of these keys is inserted and set to the corresponding position on the Clerk Locks. Each of the keys may be inserted and pulled out in the neutral position marked with "." (point) in the above figure.

PUSH-STYLE CLERK KEYS (optional type)



These keys are the alternative option with the "CLERK LOCKS" and "Clerk Keys" described above.

The register will not operate unless one of these keys (1, 2, 36) is pushed down. Pushing the same key again or pushing down another key will make the first key come up to regain to the OFF position.

DISPLAY

The operator's display (front display) is located at the top of the register just above the keyboard. The customer's display is located on the other side of the operator's display; it is in a pop-up style, and is used as rear display in the fixed status or as remote display if it is stretched up and turned to the desired direction.

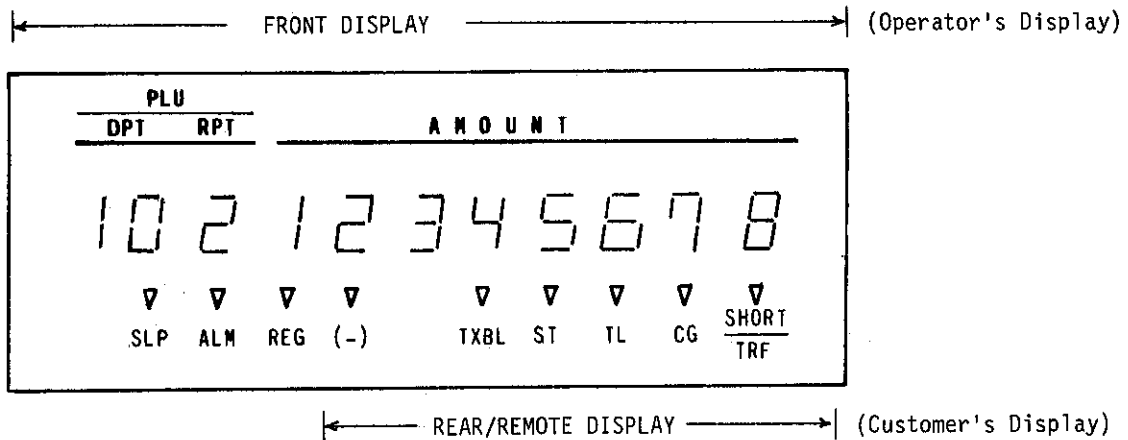

NUMERIC DISPLAY

- AMOUNT (8 digits):** Displays the numeric data, such as amount, quantity, etc.
- DPT (2 digits):** Displays the code which represents each Department Key. It stays lit when repeating the same department entry.
- RPT (1 digit):** Displays the repeat count of a Department item.
- PLU (3 digits; commonly used with the DPT and RPT digits):**
Displays the PLU code when any PLU is entered. It stays lit when repeating the same PLU entry.

MESSAGE DESCRIPTORS (TRIMARK LAMPS)

- SLP:** Lights up when a slip has been properly inserted into the validation slot to allow validation. It flickers to require a slip insertion when validation compulsion is programmed on the transaction key just operated.
- ALM:** Lights up with the alarm buzzer to indicate that the last operation or numeric entry has resulted in an error. To clear the error condition, depress the [C] key.
- REG:** Lights up when sale items has been entered.
- (-):** Lights up when the [RTN MDSE], [DOLL DISC], [%-], or [ITEM CORR] key has been operated.
It also lights up when the [ST] or one of the total keys has been depressed and the displayed amount is negative.
It lights up also when an amount is entered in the "☐" mode.

- ▼
TXBL: Lights up when a taxable department or PLU is entered.
It also lights up with the 'ST' Lamp when the [TXBL TL] key is depressed.
- ▼
ST: Lights up when the sub-total amount is displayed after the [ST] key has been depressed.
- ▼
TL: Lights up on a finalizing operation with the total amount displayed when a sale is finalized without any amount tendered.
- ▼
CG: When an amount tendering operation has been performed, this lamp lights up with the change due displayed.
- ▼
SHORT: Lights up when the amount tendered is less than the sale total with the shortage amount displayed.

KEYBOARD LAYOUT

The following is a typical keyboard layout for the MA-230-100 series. Since this series is designed to be capable of programming most of the keys in the most desired location on the keyboard, this is merely an example. Please contact your TEC representative if any other alternative or additional keys must be installed, referring to the description of the "FUNCTION OF EACH KEY".

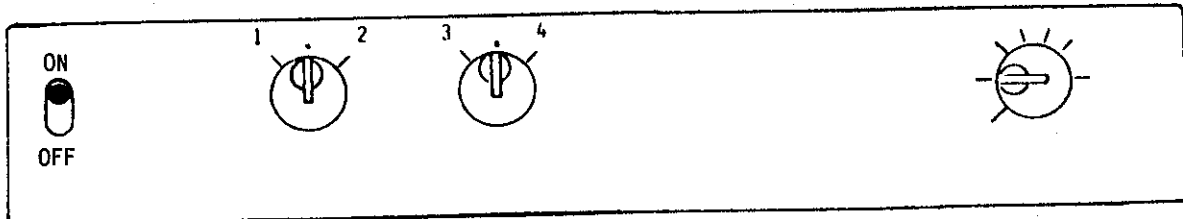

#/NS

VALI DATE	RF	JF
--------------	----	----

LC OPEN	%-	DOLL DISC	R/A	PO
------------	----	--------------	-----	----

RTN MDSE
@/FOR
AMT
PLU

C	ITEM CORR	TX/M
7	8	9
4	5	6
1	2	3
0	00	.

		PB+	PB-
1	6		
2	7	ST	TRF
3	8	TXBL TL	MISC
4	9	AT/TL	Chg
5	10		CHK TND

FUNCTION OF EACH KEY



RECEIPT ON/OFF SWITCH ... [RECEIPT ON/OFF]

This switch has two positions available, 'OFF' and 'ON' positions. When in the 'OFF', no receipt is issued from the register and sales are printed on the audit roll only. When the switch is slid to the 'ON' position, sales are printed on both receipt roll and journal roll, then a receipt is issued which is automatically cut off and then given to the customer.

NS

NO-SALE KEY ... [NS]

This key is used to open the cash drawer whilst the machine is outside a sale (for such purposes as giving changes and checking the receipt and journal print condition).

Usually, a non-add number may be entered prior to a no-sale operation. However, it can be programmed to prohibit a non-add number entry when a no-sale is operated.

RTN
MDSE

RETURNED MERCHANDISE KEY ... [RTN MDSE]

This key is used for refunding money to a customer who has returned purchased items to the store.

To operate, depress [RTN MDSE] before or during an item entry sequence using [DEPARTMENT] or [PLU] key. The amount is automatically printed and deducted from the bill.

The [RTN MDSE] key may be programmed to require validation print and/or manager intervention.

@/FOR

QUANTITY EXTENSION / SPLIT-PACKAGE PRICING KEY ... [@/FOR]

This key is used to multiply a department or PLU item entry by a quantity. This key is also used for split-package pricing of a department or PLU item.

The basic order of multiplication is:

QUANTITY → [@/FOR] → UNIT PRICE

As for details of multiplication and split pricing for various cases, refer to the "REGISTERING PROCEDURE FOR SALES" later described.

The quantity can be a maximum of 3 integral digits and 3 decimal digits. The unit price can be a maximum of 6 digits. The product must not exceed 8 digits. When a decimal portion is required for the quantity, use the [.] key.

Usually, the fraction below the least significant digit will be rounded off. However, it may be programmed to be discarded or rounded up by the system option.

PLU

PLU (Price-Look-Up) KEY ... [PLU]

This key is used to enter a PLU item that is linked to a department.

To enter the price through a PLU:

[Preset PLU Code] [PLU] ... The preset price will automatically be read and entered. To repeat the same PLU, depress the [PLU] key again, after the above operation.

[Open PLU Code] [PLU] [Amount] [AMT] ... To repeat the same PLU with the same amount, depress the [AMT] key again after the above operation.

As for quantity extension and split-package pricing involving PLUs, refer to the "REGISTERING PROCEDURE FOR SALES".

Each PLU is programmed with a 3-digit PLU code (1 to 999), a 2-digit linked department code, and a maximum of 6-digit preset price. Each PLU's tax status is ruled by the linked department status.

ITEM
CORR

ITEM CORRECT KEY ... [ITEM CORR]

This key is used to delete the last item within a transaction.

Depressing this key once will remove the last line item from the bill, printing a line through that item on the receipt and journal.

The item-correct function is effective even when a numeric entry and a [C] key depression have been performed between the item-to-be-corrected and the [ITEM CORR] key depression. However, if any other key-in operation including an error comes inbetween, the item correct will not function any more.

The [ITEM CORR] may function to correct any last item entered through a department, PLU, [%+], [%-], [DOLL DISC], [TAX](Manual Tax), [PB+], [PB-], [R/A], or [PO] key. But a department or PLU item entered with [RTN MDSE] key, a media key entry (including short-tendering), sub-total read line, partial payment entry for charge posting, [EX], or non-add # print cannot be item-corrected.

VALI
DATE

VALIDATION KEY ... [VALIDATE]

This key is used to print a validation slip.

To operate, after registering the required item, insert a slip into the validation slot and depress the [VALIDATE] key. The item and the amount will be printed on the slip.

The system option provides program selections as to single- or multi-validation, validation compulsion on certain transaction keys, and print/non-print of date and/or consecutive No.

RF

RECEIPT FEED KEY ... [RF]

This key is used to advance the receipt roll. It is operated by depressing the key and holding it in that position until the paper has advance to the required position.

The receipt roll can be advanced even when the [RECEIPT ON/OFF] switch is in the OFF position. Receipt feeding even during a sale is allowed.

JF

JOURNAL FEED KEY ... [JF]

This key is used to advance the journal roll in the same fashion as the RF key. This key is useful if the cashier, due perhaps to an interruption whilst ringing up a sale, is unsure which items have already been entered. By using this key, the cashier can see which figures have actually been printed.

The RF and JF keys can not be operated simultaneously.

C

CLEAR KEY ... [C]

This key is used to correct a numeric entry error or a declaration key (such as [RTN MDSE]) entry error if prior to depressing any other function key, or to correct any error condition and cancel the alarm buzzer.

If the [C] key is depressed after a subtotal is obtained, the subtotal is then displayed.

TX/M

(for single-tax area) ... [TX/M]

TX1/M

TX2/M

(for dual-tax area) ... [TX1/M], [TX2/M]

TX1/M

TX2/M

TX3/M

(for triple-tax area) ... [TX1/M], [TX2/M], [TX3/M]

TAX MODIFIER KEYS

Each of these keys is used to reverse the taxable/non-taxable status on departments, PLUs, or other tax-programmable keys for one entry only. Each of these key will function independently with its own tax table pre-programmed for taxable items from the others.

The tax modifier key(s) will be effective to reverse the tax status programmed on Departments, PLUs, [DOLL DISC], [%+], and [%-] keys.

To operate, depress the required tax modifier key prior to depressing any of these function keys above listed, i.e., either before or after the amount entry.

7	8	9
4	5	6
1	2	3
0	00	

NUMERIC KEYS

These are used to enter numeric values such as amount, quantity, or code number.

Depressing the [00] key once is the same as depressing the [0] key twice consecutively.

The maximum listing capacity is 8 digits for inputting a numeric value only, and 7 digits for registration except that a non-add # may be entered in maximum 8 digits.

.

DECIMAL POINT KEY ... [.]

This key is used, as part of the numeric keys, to designate the position of the decimal point when entering a percent rate or a quantity with a decimal portion. For example, to enter 0.5%, index 0+[.]>5, or [.]>5.

When entering a price or amount such as \$0.25, just index 2>5. In this case, depression of the [.] key is not necessary and will cause an error.

AMT

AMOUNT KEY ... [AMT]

This key is used to enter an amount or price for an open PLU. Refer to the description for the "[PLU]" key on page 7.

PR OPEN

PRESET OPEN KEY ... [PR OPEN]

This key is used to modify the status of preset department keys. When the [PR OPEN] is depressed prior to depressing a preset department key (either before or after the numeric entry), the preset department key is reversed to non-preset and allows amount entry through the numeric keyboard.

If a preset department is entered with a price through the numeric keyboard using the [PR OPEN] key in the above mentioned manner, no repeat operation for the same price entry is then possible for that department key.

The [PR OPEN] key can not be used with the [PLU] key.

LC OPEN

LISTING CAPACITY OPEN KEY ... [LC OPEN]

This key is used to release the listing capacity on each Department. To operate, depress the [LC OPEN] key before depressing the department key (either before or after the numeric entry).

By depressing the [LC OPEN] key, the HALC (High Amount Listing Capacity) will be released to allow a numeric entry with two further digits.

In order to allow a numeric entry exceeding the values defined above, the Mode Lock must be turned to the "MGR" position by the store manager.

Repeat operation will be possible on any department key even when the [LC OPEN] key is depressed before the department entry.

#

NON-ADD NUMBER PRINT KEY ... [#]

This key is used to print a non-add number (such as Customer No., Check No., Credit Card No., etc.) on the receipt and journal for future reference.

To operate, enter a maximum of 8-digit number and then depress this key. The number is then printed. This operation may be performed any time between items, before or after all the sale items as long as the sale is not yet finalized.

Usually, non-add numbers may be entered any number of times within a sale. However, it is programmable to prohibit more than one non-add number entry within a sale.

DOLL
DISC

DOLLAR DISCOUNT KEY ... [DOLL DISC]

This key is used to subtract an amount from the sale total such as a discount during a sale. This key cannot normally be used outside a sale. An amount exceeding the sale total cannot normally be entered. However, when the "Credit Balance" option has been selected, this key can be used inside or outside the sale and over-subtraction of the sale is allowed.

To operate, enter the discount amount on the numeric keyboard, and then depress [DOLL DISC] key.

The tax modifier keys may be used prior to the [DOLL DISC] key depression if the taxable or non-taxable status of the discount amount is to be reversed.

1

to

10

DEPARTMENT KEYS ... [DEPT]

These are department keys through which sales items are registered. These keys may be programmed as either 'OPEN' or 'PRESET' keys.

OPEN DEPARTMENT KEY

A department key which has no preset price programmed is an 'OPEN' key and must have a price entered into it manually each time. The price is rung up on the numeric keyboard and the appropriate department key is depressed. The price is then displayed and printed on the receipt and journal rolls.

When the same department key is depressed more than once after a price entry, the price entry is repeated as many times as the department key is depressed.

To enter a price extended by multiplication, enter the quantity first, depress the [€/FOR] key, enter the unit price, and then depress the appropriate department key. A multiplication entry will not be repeated by depressing the same department key again.

PRESET DEPARTMENT KEY

A preset key is a key which has already price programmed in it. It is therefore unnecessary to enter the price of an item; simply depress the key to register the sale of one item.

To multiply a preset department price by a quantity, enter the quantity first, depress the [€/FOR] key, and then depress the preset department key. The [€/FOR] key in this sequence may be omitted when the quantity is of a one-digit value (1 to 9).

If a price different from the preset one must be entered, depress the [PR OPEN] key either before or after the required price entry on the numeric keyboard, prior to the department key depression.

Each department key can be programmed with positive or negative status, tax status, and HALC (High Amount Listing Capacity).

When a department is programmed as a negative department, a price entry can not be repeated by depressing the department key again. Neither can a price entry be repeated when the [RTN MDSE] or [PR OPEN] key has been depressed prior to any department key depression.

The department keys may be programmed to be used as "Single-item" keys. See the description of "Single-item Department Keys" on page 17.

)+

PERCENT CHARGE KEY ... [%+]

This key is used to add a percent rate to a sale. If the preset rate is to be added, depress the [%+] key without a prior numeric entry. If a rate different from the preset one is required, enter the desired rate on the numeric keyboard and then depress the [%+] key. The manual rate will take priority.

To operate, depress the [%+] key either immediately after a department entry if only that item requires the percent addition, or after the [ST] key has been depressed if required on the total bill. The percent rate and the amount are printed and added to the sales total.

The percent rate may be within the range from 0.001 to 99.9999(%). The fraction resulted from the percentage calculation is usually programmed to be rounded off. However, it can be programmed to be rounded up or discarded.

Usually, the [%+] key operations may be performed as many times as required after obtaining the sub-total. However, it can be programmed to prohibit more than once, by the system option.

The [%+] key may be operated on a PB+ (positive previous balance) entry, in addition to a department or PLU item entry.

The [%+] key is programmed with either taxable or non-taxable status. The [TX/M] key may be used to reverse this programmed tax status.

%-

PERCENT DISCOUNT KEY ... [%-]

This key operates in the same fashion as the [%+] except that operation will subtract from instead of adding to a sale.

ST

SUBTOTAL KEY ... [ST]

This key is used to obtain the subtotal amount without tax during a sale. When this key is depressed after all the items have been rung up, the subtotal of the sale is printed and displayed.

If the [ST] key is depressed more than once concecutively, the first depression only will print and display the sub-total; further depressions will only display but not print the subtotal amount.

The system option provides the selection not to print but only display the subtotal amount even on the first depression of the [ST] key.

TXBL
TL

TAXABLE TOTAL KEY ... [TXBL TL]

This key is used to obtain the contents of the main itemizer (i.e. subtotal) plus any taxes due. The amount will display only but not print.

When this key is depressed during a sale with a previous balance entry, it will display the sale total without the previous balance.

In order to allow add-on operation to follow the use of this key, the taxes are not added into any totals until an actual finalization is initiated.

Mandatory depression of this key prior to finalizing is a programmable option.

R/A

RECEIVED ON ACCOUNT KEY ... [R/A]

A received-on-account transaction is used to identify money which is in the drawer but not business. The amount entered is thus included in the "Cash(or other media)-in-drawer" total but not in the sales totals.

To operate, enter an amount of payment and then depress the [R/A] key. Repeat this operation if multiple payments are entered at a time. The payments thus entered may be finalized by the [AT/TL] (for cash payments). Other media keys may also function to finalize payments received on account if not prohibited in the system option. The above operation can only be performed when the register is outside a sale.

The [R/A] key is also used to declare the payment amount near the end of a charge posting operation. After depressing the [Chg] key to obtain the sale total, enter the amount portion to be paid in this sale and then depress the [R/A] key, followed by the media tendering or totalling operation. Refer to detail description in the "REGISTERING PROCEDURE FOR SALES" as to this operation.

The [R/A] key will not function when the Mode Lock is in the "[-]" position. Validation Compulsion may be programmed on this key.

PO

PAID OUT KEY ... [PO]

A paid-out transaction is used when an amount of money is removed from the cash drawer without relating to a sale. When the [PO] key is used, the amount entered is subtracted from the "Cash-in-drawer" total but does not affect the sales totals.

To operate, enter an amount taken from the cash drawer and depress the [PO] key while the register is in an out-of-sale condition. This operation may be repeated if multiple paid-out items are registered at a time. The paid-out amounts recorded are finalized by the [AT/TL] key only.

The [ITEM CORR] key is effective to delete a payment entry just recorded with a depression of the [PO] key, if before finalized by the [AT/TL] key.

In charge posting operation, this key is depressed to pay back all the balance to the customer, after once finalizing the account with the [Chg] key.

This key will not function when the Mode Lock is in the "[-]" position. Manager Intervention and/or Validation Compulsion may be programmed on this key.

AT/TL

CASH AMOUNT TENDERED / TOTAL KEY ... [AT/TL]

This key is used to record all cash-paid transactions, and will be able to finalize a sale operation. Usually, the key is programmed to function as both amount tender and cash total key. However, the key may be programmed to operate with enforced tendering only or as a cash total key only.

TENDER FUNCTION

After the [TXBL TL] key has been depressed, enter the amount tendered by the customer in payment of the sale, and then depress the [AT/TL] key. The change is automatically computed, displayed and printed.

If the amount tendered is smaller than the sale total, it prints the amount tendered on the receipt with the balance still due displayed, but the drawer is not yet opened. In this case, ask the customer for additional payment in cash and repeat the same tendering operation, or use another media key if the balance due is processed as a sale in that media.

TOTAL KEY FUNCTION

To obtain the total and finalize a cash sale, depress the [AT/TL] key only. The sale is finalized with the total printed and displayed, and the drawer opens.

NOTES: 1. If the [AT/TL] key has been programmed to function as "TENDER" key only and the sale total is "0" or negative, no amount tendered can be entered. In this case, the [AT/TL] key will function as the "TOTAL" key, so just depress the [AT/TL] key to obtain the total and finalize the sale.

2. If the "[TXBL TL] Compulsory" option has been selected in the system option, the [TXBLE TL] key depression for obtaining the sale total is required before finalizing any sale.

The [AT/TL] key is also used to finalize received-on-account payments or paid-out amounts.

CHK TND

CHECK TENDER KEY ... [CHK]

This is one of non-cash media keys, and used to cash a check when the register is outside a sale, or to finalize the transaction as a check payment.

CHECK CASHING

When the register is outside a sale, enter the check amount and depress the [CHK] key. A receipt is issued and the drawer is opened to enable exchange. However, this cashing function may be prohibited if so programmed in the system option.

FINALIZING AS CHECK PAYMENT

On finalizing a sale, enter the amount of the check given by the customer and depress the [CHK] key. If the amount received is larger than the sale total, the receipt is issued with the change due printed and displayed. Then the change is given to the customer in cash. If the amount received is smaller than the sale total, the shortage is displayed, and the customer may pay the additional amount in cash (or other medias) to finalize the sale by depressing the [AT/TL] (or other media) key.

The [CHK] key is also used to finalize received-on-account payments when paid in check. However, this function may be prohibited in the system option.

Over-tendering and/or short-tendering using this key may be prohibited in the system option.

Chg

CHARGE TOTAL KEY ... [Chg]

This key is usually programmed as "Charge Sale Total" Key. However, it may be programmed to be the key for other non-cash media such as payments in credit cards. Thus this key is used as an alternative method of payments for media other than cash and check. To operate, depress the [Chg] key, instead of [AT/TL], to obtain the total and finalize the sale.

This key has exactly the same functions and programmabilities as the [CHK] key except that the [Chg] key is usually programmed as a "TOTAL" key but not a "TENDER" key.

This key may also finalize received-on-account payments if not prohibited in the system option.

The [Chg] key is also used to finalize the current sale of charge posting. In this case, the amount displayed by the [Chg] key is the sale total including the previous balance.

OPEN

LC-AND-PRESET OPEN KEY ... [OPEN]

This key is a dual-function key that has both [LC OPEN] (page 9) and [PR OPEN] (page 9) key functions.

RECEIPT
ISSUE

RECEIPT POST-ISSUE KEY ... [RECEIPT ISSUE]

This key is used to issue the receipt of a sale when the sale has already been finalized with the [RECEIPT ON/OFF] switch positioned to OFF. However, the post-receipt can be issued even when the [RECEIPT ON/OFF] switch is positioned to ON if so programmed in the system option.

To operate, depress the [RECEIPT ISSUE] key without a numeric entry. The receipt for the last sale is then issued, with the sale total only printed. This key will not function if another sale has already been under way.

#/NS

NON-ADD NUMBER PRINT / NO-SALE KEY

This is a dual-function key that has both [#] (page 10) and [NS] (page 6) key functions. If depressed with a prior number entry, it will function as the Non-add Number Print key.

If depressed without a prior numeric entry when the register is outside a sale, it will function as No-sale key.

The [# / NS] key always functions as [#] key in the X or SET mode.

TAX

MANUAL TAX KEY ... [TAX]

This key is used to enter an irregular tax amount that cannot be calculated on the basis of the programmed tax table, and to add it to the sale total.

To operate, enter the desired amount of tax, and then depress the [TAX] key. The tax amount entered is then printed. This tax amount is processed into the TAX 2 memory. Therefore, the tax amount automatically calculated and printed at finalizing the sale (TAX 1) does not include a manual-entered tax, while the entire sale total printed on the receipt last line includes the manual-entered tax also.

This key is also used, if depressed without an amount entry within a sale, to display the total of only non-taxable items so far entered. Usually, this non-taxable total is only displayed but not printed. However, it may be programmed to print also.

EX

TAX EXEMPT KEY ... [EX]

This key is used to declare the exemption of the taxes from the sale, displaying the sale total balance due after subtracting the exempted tax amount and printing the sale amount subject to the tax exemption. Only a finalizing operation is possible after a [EX] key depression.

The [ITEM CORR] key will not function to delete a [EX] key entry.

If multiple tax modifier keys are installed, tax exemption operates in the following ways:

- [TX1/M] → [EX] to exempt TAX 1 only
- [TX2/M] → [EX] to exempt TAX 2 only
- [TX3/M] → [EX] to exempt TAX 3 only
- [TX1/M] → [TX2/M] → [EX] to exempt TAX 1 and TAX 2
- [TX2/M] → [TX3/M] → [EX] to exempt TAX 2 and TAX 3
- [TX1/M] → [TX3/M] → [EX] to exempt TAX 1 and TAX 3
- [EX] only to exempt all taxes
- [TX1/M] → [TX2/M] → [TX3/M] → [EX] ..

If only one tax modifier key ([TX/M]) is installed, operate the [EX] key alone for the tax exemption.

PB+

PB-

PREVIOUS BALANCE KEYS ... [PB+], [PB-]

These keys are used to enter a previous balance in a charge posting operation. If a pervious balance is entered, then the operation becomes a charge posting operation, and the [Chg] key must be used at the end of the operation. (See the "REGISTERING PROCEDURE FOR SALES" as to detail operations to follow the [Chg] key in charge posting.)

A previous balance may be entered anywhere and any number of times during a sale. The [PB+] key is used to post a debit balance and the [PB-] key is used to post a credit balance. To initiate a charge posting operation where no previous balance exists, then enter "0" (zero) as a past balance, followed by [PB+] or [PB-] key.

If the [%+] or [%-] key is used immediately after a previous balance entry through the [PB+] key, the percent rate is added to or subtracted from the previous balance. But a use of a % key after the [PB-] key will result in an error.

TRF

TRANSFER KEY ... [TRF]

When a charge posting operation is ended with the [Chg] key, this key is used to transfer the entire balance with no payment.

To operate, depress the [TRF] key after the [Chg] key. All the balance is transferred, the transferred amount is printed as the new balance, and a receipt is issued. ([Chg] may be omitted in this case.)

Additional Department Keys

A maximum of 15 department keys including the present department keys may be installed.

Single-item Department Keys

Some or all of the department keys may be programmed to be "Single-item Department Keys". A Single-item Department Key is used to quicken a single cash sale item entry process instead of depressing a department key and [AT/TL] key. On depressing a Single-item Department Key, the sale is immediately finalized and a receipt is issued.

Additional Media Key (MISC) MISCELLANEOUS MEDIA KEY ... [MISC]

The [MISC] key may be added as a non-cash media key. By adding this key, any other non-cash media sales than check and charge may be finalized with this key. The functions and programmabilities for this key are the same as the [CHK] key.

Additional % Key

A maximum of two % keys including the present % keys may be installed on the keyboard. That is, if one [%+] key and one [%-] key are already installed, no other % keys can be added. However, the two % keys can be programmed to be used as both %+ or both %- keys.

REGISTERING PROCEDURE FOR SALES

The following are patterns for actual registering operations. In the following examples, " " indicates an input through the numeric keys, "[]" indicates a depression of the transaction key, and "---" indicates other registering and/or finalizing operations.

One of the Clerk Keys must be set to the ON position to start operations.

NO-SALE (Mode Lock: REG) (Allowed only outside a sale)

[NS] (or [#NS])

DEPARTMENT ENTRY (Mode Lock: REG; or MGR for negative departments if so programmed)

PRICE [OPEN] → ---

[PRESET DEPT] → ---

[PR OPEN] PRICE [PRESET DEPT] → ---

NOTES 1. To enter a price to override the listing capacity, the [LC OPEN] (or [OPEN]) key may be depressed either before or after the price entry but before the department key depression. In this case, a price two digits larger than the preset listing capacity may be entered for that entry only.

2. Tax Modifier Keys may be used to reverse the tax status:

ex.) (PRICE) [TX/M] [DEPT] ... to reverse taxable/non-taxable status of the department in a single-tax area

(PRICE) [TX2/M] [DEPT] ... to reverse Tax2 taxable/non-taxable status of the department in a dual- or triple-tax area.

(PRICE) [TX1/M] [TX2/M] [DEPT] ... to reverse both Tax1 and Tax2 taxable/non-taxable status in a dual- or triple-tax area.
:
:
etc.

PLU ENTRY (Mode Lock: REG)

Preset PLU Code [PLU] → ---

Open PLU Code [PLU] → PRICE [AMT] → ---

NOTES 1. The [PR OPEN] key can not be used for PLU entries.
2. Tax Modifier Keys may also be used for PLU entries. Refer to NOTE 2 for the above DEPARTMENT ENTRY.

REPEAT ENTRY (Mode Lock: REG)

PRICE | [OPEN DEPT] → [OPEN DEPT] → [OPEN DEPT] ... → ---
└──────────────────────────────────┘

(Repeat depressing the same key as many times as the desired count.)

Preset PLU Code | [PLU] → [PLU] → [PLU] ... → ---

Open PLU Code | [PLU] → PRICE | [AMT] → [AMT] → [AMT] ... → ---

- NOTES** 1. Repeat entry is not possible when the [RTN MDSE] has been depressed prior to the [DEPT], [PLU], or [AMT] key.
2. The [LC OPEN] key or Tax Modifier Keys are effective on repeat operation by the above patterns.

QUANTITY EXTENSION (Multiplication) (Mode Lock: REG)

QUANTITY | → [X] → [PRESET DEPT] → ---
└──────────────────────────────────┘
(May be omitted if the QUANTITY is 1-digit.)

[PR OPEN] → QUANTITY | → [X] → PRICE | [PRESET DEPT] → ---

QUANTITY | → [X] → PRICE | → [OPEN DEPT] → ---

QUANTITY | → [X] → Preset PLU Code | [PLU] → ---

Open PLU Code | [PLU] → QUANTITY | [X] → PRICE | [AMT] → ---

- NOTES** 1. The [@/FOR] key functions the same as the [X] key in the above operation patterns.
2. The QUANTITY may be a maximum of 3 integral digits and 3 decimal digits. (Use the [.] key if the quantity contains a decimal portion.) The PRICE may be a maximum of 6 digits. The product must not exceed 8 digits for positive departments or 7 digits for negative departments and PLUs.

SPLIT PACKAGE PRICING (Mode Lock: REG)

PURCHASED Q'TY | [@/FOR] → WHOLE PACKAGE Q'TY | [@/FOR] → [PRESET DEPT] → ---

PURCHASED Q'TY | [@/FOR] → WHOLE PACKAGE Q'TY | [@/FOR] →
└──────────────────────────────────┘
└──────────────────────────────────┘
└──────────────────────────────────┘
→ WHOLE PACKAGE PRICE | [OPEN DEPT] → ---

PURCHASED Q'TY | [@/FOR] → Split-Price Type PLU Code | [PLU] → ---
(Preset PLU)

Split-Price Type PLU Code | [PLU] → PURCHASED Q'TY | [@/FOR] →
(Open PLU)
└──────────────────────────────────┘
└──────────────────────────────────┘
→ WHOLE PACKAGE PRICE | [AMT] → ---

- NOTES**
1. The "PURCHASED Q'TY" and "WHOLE PACKAGE Q'TY" must be of integral value (max. 3 digits); no decimal value is allowed.
 2. Usually, the fraction of the result is rounded up in split-pricing operation. However, it is programmable to round up the fraction of each item price (item price = WHOLE PACKAGE PRICE ÷ WHOLE PACKAGE Q'TY).
 3. Only the "Split-Price Type" PLUs allow split pricing operations, but not the other ordinary type of PLUs.

RETURNED MERCHANDISE (Mode Lock: REG; or MGR if so programmed)

Follow the operation sequences of DEPARTMENT ENTRY, PLU ENTRY (page 18), QUANTITY EXTENSION, and SPLIT PACKAGE PRICING (previous page), and depress [RTN MDSE] anywhere during the sequence (not necessarily at the starting) but it must be depressed before the last key of each sequence.

DOLLAR DISCOUNT (Mode Lock: REG; or MGR if so programmed)

--- → |DISCOUNT AMOUNT| [DOLL DISC] → ---

- NOTES**
1. Unless the "Credit Balance" option has been selected, no discount amount exceeding the sale total will be allowed.
 2. Unless the "Credit Balance" option has been selected, no amount discount operation outside a sale will be allowed.
 3. Tax Modifier Keys are effective to reverse the preset taxable/non-taxable status of the [DOLL DISC] key.

PERCENT DISCOUNT (Mode Lock: REG; or MGR if so programmed)

(1) To discount from the sub-total:

--- → [ST] → [%-] → --- ... to discount by the preset %- rate

--- → [ST] → |RATE| [%-] → --- ... to discount by a manual rate

(2) To discount from an individual department or PLU item:

(|PRICE|) → [DEPT] → [%-] → --- ... to discount by the preset %- rate

(|PRICE|) → [DEPT] → |RATE| [%-] → --- ... to discount by a manual rate

- NOTES**
1. The rate may be entered within the range from 0.001 to 99.999(%). If the rate contains the decimal point, use the [.] key.
 2. The above department entry sequence may be replaced by a PLU entry sequence.
 3. Tax Modifier Keys are effective to reverse the preset taxable/non-taxable status of the [%-] key.
 4. Percent discount/charge can also be operated on a positive previous balance entry.

PERCENT CHARGE (Mode Lock: REG)

This operates the same as the PERCENT DISCOUNT operations above, except that the [%+] key is used instead of the [%-] key.

ITEM CORRECT (Mode Lock: REG)

Depress [ITEM CORR] after each sequence listed below.

DEPARTMENT ENTRY (page 18) →
PLU ENTRY (page 18) →
REPEAT ENTRY (page 19) →
QUANTITY EXTENSION (page 19) →
SPLIT PACKAGE PRICING (page 19) → → [ITEM CORR] → ---
DOLLAR DISCOUNT →
PERCENT DISCOUNT (page 20) →
PERCENT CHARGE (page 20) →
RECEIVED ON ACCOUNT: [AMOUNT] [R/A] →
PAID OUT: [AMOUNT] [PO] →
MANUAL TAX: [AMOUNT] [TAX] →
PREVIOUS BALANCE: [AMOUNT] [PB+](or [PB-]) →

- NOTES**
1. When [ITEM CORR] is depressed after a REAT ENTRY sequence, only the last item of the repeated will be deleted.
 2. When [ITEM CORR] is depressed after a QUANTITY EXTENSION or SPLIT PACKAGE PRICING sequence, the entire product resulted from the calculation will be deleted.

NON-ADD NUMBER PRINT (Mode Lock: REG)

[Reference No. or Code No.] [#](or [# / NS]) → ---
max. 8 digits
└ (Check No., Customer No., Credit Card No., etc.)

CHECK CASHING (Mode Lock: REG) (Allowed only outside a sale)

[Amount of check to be cashed] [CHK]

... The drawer opens and a receipt is issued. Receive the check and pay the amount in cash to the customer.

- NOTES**
1. Check cashing may be programmed to be prohibitive in the system option.
 2. The [Chg] and/or [MISC] key may also be operated for the media cashing if so programmed in the system option.

SUBTOTAL (Mode Lock: REG)

--- → [ST] → --- ... The sale total so far is displayed and printed, but the sale is not finalized.

- NOTES**
1. Non-print of the subtotal amount (but only display) on a [ST] key depression may be programmed.
 2. The subtotal amount will only be displayed but not printed from the second consecutive depression of the [ST] key.
 3. If the [C] key is depressed to clear an error or a numeric entry after once obtaining a subtotal, the subtotal amount will again be displayed.

TAXABLE TOTAL READ (Mode Lock: REG)

--- → [TXBL TL] → --- ... The sale total including taxes is displayed but not printed. The sale is not finalized. In charge posting operation, the amount displayed by a [TXBL TL] key depression does not include the previous balance.

- NOTES**
1. If the [C] key is depressed after the [TXBL TL] key has once been depressed, the sale total including taxes is then displayed.
 2. Mandatory depression of this key is a programmable option.

MANUAL TAX ENTRY (Mode Lock: REG)

--- → | TAX AMOUNT TO BE ADDED | [TAX] → ---

NON-TAXABLE ITEM TOTAL READ (Mode Lock: REG)

--- → [TAX] → --- ... The total of the non-taxable item(s) so far entered within the sale is displayed. It is usually not printed, but programmable to print if required.

TAX EXEMPTION (Mode Lock: REG; or MGR if so programmed)

--- → [TX1/M] → [EX] ... to exempt Tax1 only

--- → [TX2/M] → [EX] ... to exempt Tax2 only

--- → [TX3/M] → [EX] ... to exempt Tax3 only

--- → [TX1/M] [TX2/M] → [EX] ... to exempt Tax1 and Tax2

--- → [TX1/M] [TX3/M] → [EX] ... to exempt Tax1 and Tax3

--- → [TX2/M] [TX3/M] → [EX] ... to exempt Tax2 and Tax3

--- → [EX] ... to exempt all the taxes (All the Tax Modifier Keys may be depressed before [EX].)

Displays the sale total balance due after subtracting the exempted tax amount and prints the sale amount subject to the tax exemption.

CASH TOTAL (Mode Lock: REG)

--- → ([TXBL TL]) → [AT/TL] ... The drawer opens, the sale total is displayed and printed, and a receipt is issued.

CASH TENDERING (Mode Lock: REG)

--- → ([TXBL TL]) → | CASH AMOUNT TENDERED | [AT/TL] ... The drawer opens, the change due is displayed, and a receipt is issued with the amount tendered and the change due printed.

CHECK TENDERING (Mode Lock: REG)

--- →([TXBL TL]) → |CHECK AMOUNT TENDERED| [CHK]

CHARGE TOTAL (Mode Lock: REG)

--- →([TXBL TL]) → [Chg]

MULTI-TENDERING (Mode Lock: REG) -- Short-tendering repeated multiple times by the same media (allowed only when the media key is programmed to allow short-tendering).

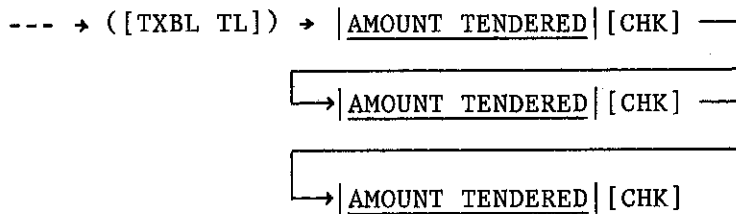

NOTE: The [CHK] key may be replaced by the [AT/TL] or [Chg] key if it is programmed to allow short-tendering.

SPLIT-TENDERING (Mode Lock: REG) -- Short-tendering repeated multiple times by different medias (allowed only when the media keys are programmed to allow short-tendering).

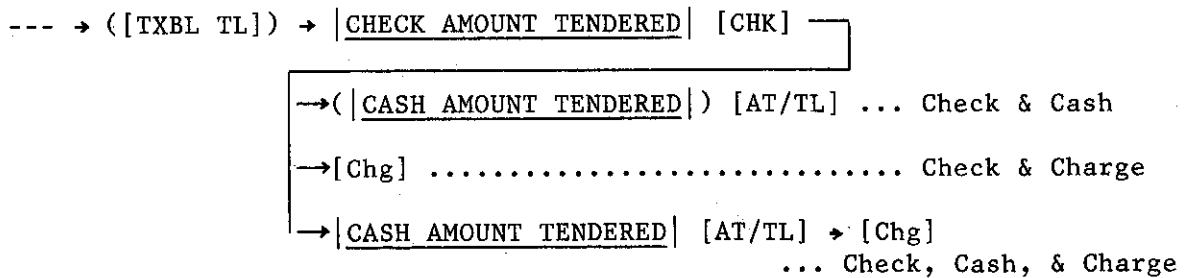

--- → ([TXBL TL]) → |CASH AMOUNT TENDERED| [AT/TL] - [Chg]
... Cash & Charge

- NOTES**
1. In both MULTI-TENDERING and SPLIT-TENDERING operations, the sale is finalized, a receipt is issued, and the drawer opens on reaching the sale total amount.
 2. If a media key is depressed without an amount tender entry (if the key functions as the "TOTAL" key), the sale is then finalized on that stage processing all the balance into that media.

RECEIVED ON ACCOUNT (Mode Lock: REG) (Allowed only outside a sale)

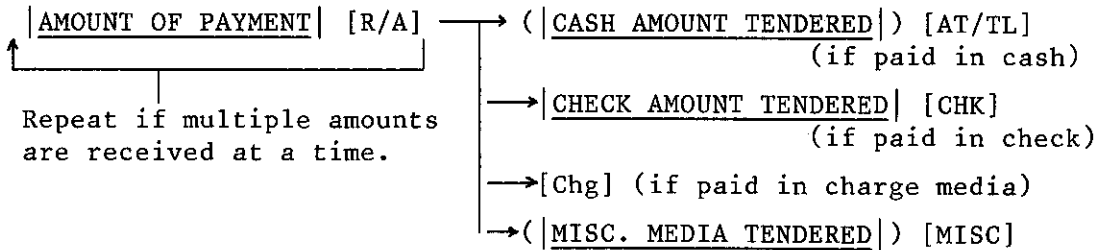

NOTE: Each of the [CHK], [Chg], and [MISC] keys may not be used for finalizing R/A entries if prohibited in the system option. MULT-TENDERING and SPLIT-TENDERING are applicable to the finalization of received-on-account payments.

PAID OUT (Mode Lock: REG; or MGR if so programmed) (Allowed only outside a sale)

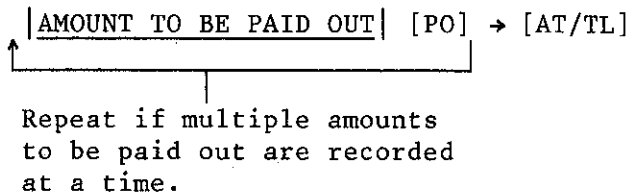

NOTE: The [AT/TL] is the only media key that can finalize paid-out amounts.

VALIDATION PRINT (Mode Lock: REG or MGR)

After entering the required item through a transaction key or a media key.

Insert a validation slip into the validation slot. Make sure that the "SLP" Lamp is steadily lit. → [VALIDATE]

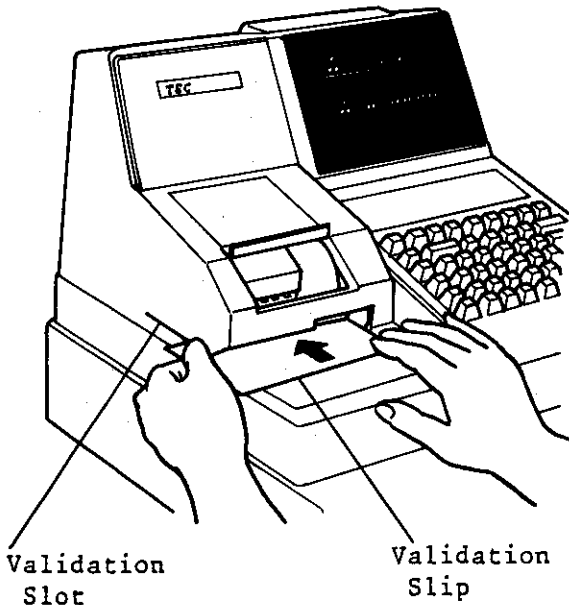

- NOTES**
1. No other operations can follow until the validation slip once printed is withdrawn.
 2. If the "SLP" Lamp flickers during operations, it indicates that the last item registered has been programmed to require validation print. In this case, no other operations can follow until a validation print is executed.
 3. The following are the selections programmable relating to validation:
 - (1) PRINT FORMAT:
 - a) Date Print/Non-print
 - b) Consecutive No. Print/Non-print
 - (2) MULTI-VALIDATION or SINGLE-VALIDATION (Number of times of validation print allowed for the same item)
 - (3) VALIDATION COMPULSORY status on the following keys:
[AT/TL], [CHK], [Chg], [MISC],
[RTN MDSE], [PO], [R/A], [%-],
[ITEM CORR], [TRF], [DOLL DISC],
Negative [DEPT]

PREVIOUS BALANCE, CHARGE POSTING (Mode Lock: REG)

1. TO INITIATE CHARGE POSTING WHERE NO PREVIOUS BALANCE EXISTS:

[0] → [PB+] (or [PB-]) → To be continued to the "*" below.

2. CHARGE POSTING WITH A PREVIOUS BALANCE FIRST ENTERED (PRE-SELECT):

[Previous Balance] → [PB+] (for Debit Balance) → _____
 → [PB-] (for Credit Balance) → _____

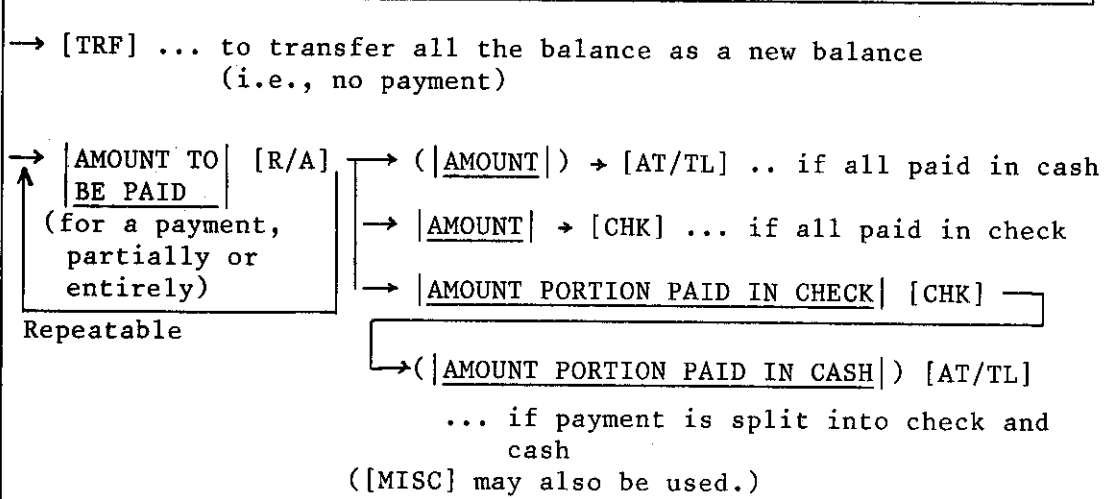
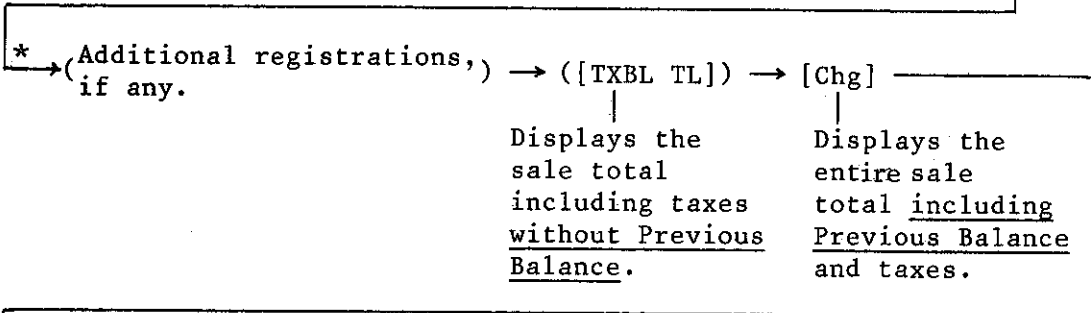

- NOTES**
1. The operation is finalized on a media key when the indexed amount total reaches the amount declared through the [R/A] key. The media keys used for payment must be programmed to allow "R/A Finalization".
 2. If the amount entered prior to a media key (that must function as "Tender" key) is larger than the amount declared through the [R/A] key, then it is finalized with the change computation.
 3. When the [TRF] key is to be operated to transfer all the balance, the prior [Chg] key may be omitted.

→ [PO] ... when the balance is negative and must be paid back to the customer in cash.

3. PERCENT CHARGE/DISCOUNT ON A PREVIOUS BALANCE: (on Positive PB only)

[PREVIOUS BALANCE] [PB+] → ([MANUAL RATE]) [%+](or[%-]) → continued to * above.

4. CHARGE POSTING WITH A PREVIOUS BALANCE ENTRY DURING SALE (POST-SELECT):

A previous balance may be entered not only before other sales items but also after or between them if the [Chg] key has not been depressed. Multiple previous balance entries are possible within a sale. Even PB+ and PB- may be entered within a sale.

ENTRY IN THE "" (NEGATIVE) MODE (Mode Lock:)

When several items are returned at a time, turn the Mode Lock to the position using the MA key which is kept by the store manager. Then enter each item just as in the normal registering operation made in the "REG" mode. The position of the Mode Lock processes the entered items exactly in the reverse way, i.e., positive items into negative, and negative into positive.

The positive total balance resulted in the mode indicates the amount to be refunded to the customer.

RECEIPT POST-ISSUE (Mode Lock: REG) (Allowed only outside a sale)

[RECEIPT ISSUE] ... A receipt with the total amount of the last-finalized sale is issued. The system option provides the selection not to issue the post-receipt if the last sale has been finalized with the [RECEIPT ON/OFF] switch positioned to 'ON'.

REGISTERING RECEIPT SAMPLES

No-sale

Thank you
Call again

12-10-85
123456

1 1/2 * 1/2
00.38 1/2
14-09

Store Name/Message Stamp

Date: Oct.10, 1985

Register No.

No-sale Symbol

Clerk ID

Receipt Consecutive No.

Current Date

Check Cashing

Thank you
Call again

12-10-85
123456

1 1/2 * 15.00 1/2
00.42 1/2
14-17

Check Amount Cashed

Received on Account

Thank you
Call again

12-10-85
123456

-----*50.00-
*5.00
*5.00

1 1/2 * 5.00
00.39 1/2
14-10

Payment Amount \$50.00,
which is item-corrected

Payment Amount \$5.00

Payment Total
received

Paid Out

Thank you
Call again

12-10-85
123456

*5.00
*2.00
*7.00

1 1/2 * 7.00
00.40 1/2
14-15

Paid-out Amount \$5.00

Paid-out Amount \$2.00

Paid-out Total

Single-item Department

Thank you
Call again

12-10-85
123456

09 * *1.20
 *1.20 CA FL
10 1 ***E
00.67
15-06

Dept.9 \$1.20
immediately
finalized as cash

Department, Repeat, Quantity Extension

Thank you
Call again

12-10-85
123456

01 * *1.20 TM
02 * *2.10 TM
02 * *2.10 TM
5 X 1.60 @
03 * *8.00 TM X
 *1.34 TX
 *14.74 CA FL
10 8 ***E
00.41
14-16

Dept.1: \$1.20
Dept.2: \$2.10
Repeated
5 x \$1.60@
= \$8.00 into Dept.3
Tax due
Finalized as Cash Sale
Clerk ID / Purchased
Item Count

PLU, Quantity Extension, Split Package Pricing

Thank you
Call again

12-10-85
123456

201 2 *2.40 TM
3 X 1.00 @
50.1 2 *3.00 TM
6 * 1.00 @
2 X
30.1 2 *0.32 TM
 *0.57 CA TX FL
 *6.29
10 6 ***E
00.43
14-18

PLU 201: \$2.40
3 x \$1.00@ = \$3.00
into PLU 501
Out of 6 items in
a package of PLU 301,
2 item purchased.

Returned Merchandise

Thank you
Call again

12-10-85
123456

01 * *2.50 TM
20.1 2 *2.40 TM
 -0.49 TX
 -5.39 CA FL
10 -2 ***E
00.49
14-27

Dept.1 \$2.50 returned
PLU 201 \$2.40 returned
Tax returned
Cash Total to be
refunded

Dollar Discount

Thank you
Call again

12-10-85
123456

04*	*1.00	TM
20.2	*1.85	TM
	-0.50	
	*0.24	CA TX
	*2.59	FL
1 2	***E	
00.44		
14-20.		

Dollar Disc.: \$0.50

Percent Discount

Thank you
Call again

12-10-85
123456

04*	*1.00	TM
20.	-0.20	% -
20.2	*1.85	TM
	*2.65	ST
20.	-0.53	% -
	*0.29	CA TX
	*2.41	FL
1 2	***E	
00.45		
14-21.		

20% Discount from
Dept.4 item above

20% Discount from
the Subtotal above

Item Correction

Thank you
Call again

12-10-85
123456

01*	*5.00	TM
01*	*5.50	TM
20.1	*2.40	TM
20.2	*1.85	TM
	*0.74	CA TX
	*8.09	FL
1 2	***E	
00.46		
14-21.		

Dept.1 \$5.00,
item-corrected

PLU 201 \$2.40,
item-corrected

Tax Exemption

Thank you
Call again

12-10-85
123456

04*	*1.00	E
07*	*2.50	
1	*1.00	
	*3.50	CA FL
1 2	***E	
00.50		
14-30.		

Tax 1 Exemption,
Amount "1.00" is the
sale amount subject
to this tax exemption.

Manual Tax

Thank you
Call again

12-10-85
123456

05 * *1.20
06 * *2.30
 *0.10
 *3.60
 ***E

1 2 2
0 1 3 2
0 8 - 2 7

Manual Tax \$0.10

Non-add Number, Charge Total

Thank you
Call again

12-10-85
123456

4 X 2.50 @
07 * *10.00
#444
 *10.00
1 2 4
0 0.60
1 4 - 5 3

Non-add No.444
Finalized as Charge
Sale

Split-tendering

Check Tender

Thank you
Call again

12-10-85
123456

04 * *1.00 TM
07 * *2.50
 *0.10 TX
 *3.60 TX
 *5.00 CK
 *1.40 TL
 ***E

1 2 2
0 0.55
1 4 - 3 2

Sale Total
Check Tendered
Change due

Thank you
Call again

12-10-85
123456

04 * *1.00 TM
07 * *2.50
04 * *1.00 TM
07 * *2.50
 *0.20 TX
 *7.20 TL
 *3.00 CK
 *2.00 CA
 *2.20 CH
1 2 4
0 0.59
1 4 - 3 4

Sale Total
Check-paid Portion
Cash-paid Portion
Charge-paid Portion

Previous Balance, Charge Posting

Debit Balance Sample

Thank you
Call again

12-10-85
#123456

PB	*0.00		
08*	*2.10	TM	
09*	*3.20	TM	
	*0.53	CH	TX
	*5.83	TL	
	*5.83	TF	CA

10 2 ***IM
0137 NO
08-33

CHARGE POSTING
INITIATION
(for a new customer)

Credit Balance Sample

Thank you
Call again

12-10-85
#123456

PB	*0.00		
03*	*1.60	TM	
	*0.16	CH	TX
	*1.76	TL	
	*5.00	CA	TL
	*5.00	CA	TL
	-3.24	TF	CA

10 1 ***IM
0140 NO
08-37

CHARGE POSTING
INITIATION
(for a new customer)

Previous Balance "0"
Sale Items
All Balance Transfer

Previous Balance "0"
Sale Item
\$5.00 paid in cash
Negative Balance Transfer

#123470

PB	*5.83		
80.1 PU	*2.00		
02*	*2.00	TM	
	*0.20	CH	TX
	*10.03	TL	
	*5.00	CA	TL
	*5.00	CA	TL
	*0.00	CG	
	*5.03	TF	CA

10 2 ***IM
0138 NO
08-34

Previous Balance
Sale Items
Sale Total
Partial Payment
\$5.00 in check
New Balance

#123470

PB	-3.24		
	-3.24	CH	TL
	*3.24	CG	TL
	*0.00	TF	CA

10 0 ***IM
0141 NO
08-38

Previous Balance
The balance is negative; therefore, paid back to the customer in cash.

#123470

PB	*5.03		
	*5.03	CH	TL
	*5.03	CA	TL
	*5.03	CA	TL
	*0.00	TF	CA

10 0 ***IM
0139 NO
08-35

Previous Balance
Sale Total
All Paid in cash

Normal Receipt

```

Thank you
Call again

12-10-85
  123456

03*      *150  TM
10*      *320  TM
70.1 PU  *150  TM
          *062  CA TX
          *682  TL
10 3     ***  IE
0133  2
08-29
    
```

Post-issue Receipt

Post-issue Receipt (issued with [RECEIPT ISSUE] Key)

```

Thank you
Call again

12-10-85
  123456

10      *682  FL
0133  2
08-29
    
```

Only the sale total amount is printed on a Post-issue Receipt.

Receipt Issued in REG or MGR mode

```

Thank you
Call again

12-10-85
  123456

03*      *130  TM
5        X 210  @ TM
02*      *1050 TM
00.2 PU  *175  TM
          -020
          *136  CA TX
          *1471 TL
10 7     ***  IE
0134  2
08-30
    
```

ex.) A customer who once purchased items listed in the left receipt comes up to return all the items. The clerk asks the store manager to turn the Mode Lock to the [] position, and registers all the items, one by one, following the customer's receipt. The contents of the two receipts are same except that the Negative Mode Header (** RTN) is printed on the right one. The total amount in the right-side receipt must be returned to the customer.

Negative Mode ([] Entry

Receipt Issued in [] mode

```

Thank you
Call again

12-10-85
  123456

03*      **      RTN
5        X 210  @ TM
02*      *1050 TM
00.2 2    *175  TM
          -020
          *136  CA TX
          *1471 TL
10 7     ***  IE
0135  2
08-31
    
```

- Negative Mode Header

VALIDATION PRINT SAMPLES

RECEIPT

VALIDATION TIMING

VALIDATION PRINT

Thank you
Call again

12-10-85
123456

01* *120 TM
10 %+

7012 *012
 *150 TM
 *027 TX
07** *3.09 FL

12 2 ***E
0148
08-47.

Date (Month-Day)	Receipt Consecutive No.	Symbol/ID of Dept, PLU, etc.	Amount	Transaction ID
12-10	0148	01*	*120	TM

12-10	0148		*012	
-------	------	--	------	--

12-10	0148	7012	*150	TM
-------	------	------	------	----

after [TXBL TL] key (allowed only when the "Total Validation" option is selected.)

12-10	0148	12	*3.09	FL
-------	------	----	-------	----

12-10	0148	12	*3.09	FL
-------	------	----	-------	----

READ(X) AND RESET(Z) REPORTS

The following table shows the key operation to take each report. The "X" and "Z" reports have exactly the same content print if both are available, except that:

1. The "X" reports allow to read the sales data but not clear memories, while the "Z" reports allow to read the sales data and at the same time all the resettable memories will be cleared when the reports have been issued.
2. The symbol "X" is printed on the top line of an "X" report, while "Z" is printed on a "Z" report, to indicate the type of report.
3. A reset count is printed on the bottom of a "Z" report only.

TABLE OF OPERATIONS FOR X AND Z REPORTS

REPORT NAME	KEY OPERATION
* <u>MEDIA-IN-DRAWER READ</u> (If a media is programmed not to print its "In-drawer Total" on reports, that media-in-drawer total will not be printed in this report.)	Mode Lock: X → [#] (or [#NS])
<u>PLU READ AND RESET</u>	
ZONE PLU READ ZONE PLU RESET	Mode Lock: X → Start PLU Code → [X] Mode Lock: Z → End PLU Code → [PLU]
ALL PLU READ ALL PLU RESET	Mode Lock: X → [PLU] Mode Lock: Z → [PLU]
<u>INDIVIDUAL DEPARTMENT READ</u> (All Department Read/Reset is contained in the AUTO READ/RESET reports.)	Mode Lock: X, depress the required Dept Keys, one by one. [ST] may be used to obtain subtota, [AT/TL] to end.
<u>DEPARTMENT GROSS PROFIT READ</u>	Mode Lock: X → 12 [AT/TL]
<u>HOURLY READ AND RESET</u>	
HOURLY READ HOURLY RESET	Mode Lock: X → 10 [AT/TL] Mode Lock: Z → 10 [AT/TL]
* <u>CLERK READ AND RESET</u>	
INDIVIDUAL CLERK READ INDIVIDUAL CLERK RESET (All Clerk Read/Reset is contained in the AUTO READ/RESET reports.)	Mode Lock: X → Set the required Clerk Key to ON → 1 [AT/TL] Mode Lock: Z → 1 [AT/TL] NOTE: INDIVIDUAL CLERK READ/RESET reports are available only when the "4-Clerk Key-locks" status is selected in the system option.

-- To be continued --

TABLE OF OPERATIONS FOR X AND Z REPORTS -- Continued --

REPORT NAME	KEY OPERATION
* <u>AUTO READ AND RESET</u> (DEPARTMENT + FINANCIAL + CLERK + DEPT GROSS PROFIT) Print/Non-print Selective AUTO READ AUTO RESET	Mode Lock: X <input type="checkbox"/> → [AT/TL] Mode Lock: Z <input type="checkbox"/> → [AT/TL]
<u>GT READ AND RESET (Accumulated Data)</u>	
* AUTO GT READ * AUTO GT RESET DEPARTMENT GROSS PROFIT GT READ	Mode Lock: X <input type="checkbox"/> → 20 [AT/TL] Mode Lock: Z <input type="checkbox"/> → 20 [AT/TL] Mode Lock: X → 22 [AT/TL]

- NOTES**
1. The drawer will open on the depression of the final key of the KEY OPERATION for the reports marked with "*" in the above table.
 2. No Clerk Key is necessary to issue reports except CLERK READ AND RESET.
 3. Refer to the report samples on the following pages. As for the program data reading, which is available in the "X" mode, see the "VERIFICATION OF PROGRAMMED DATA" in the PROGRAMMING MANUAL.

REPORT PRINT SAMPLES

MEDIA-IN-DRAWER READ

Mode Lock: X, depress [#](or[#/NS])

```

Thank you
Call again

12-10-85
  123456

      X
    *216.16  CA
    *100.00  CHCK
      *3.78  ID
      *0.00  ID ID
0 0
00.19  NO
16-02

```

```

Cash-in-drawer Total
Check-in-drawer Total (Print/Non-print Option)
Charge-in-drawer Total (Print/Non-print Option)
Misc.-in-drawer Total (Print/Non-print Option)

```

ZONE PLU READ or RESET

Mode Lock: X for READ] Enter the starting PLU Code, [X],
 Mode Lock: Z for RESET] enter the ending PLU Code, [PLU].

Read Report Sample

```

Thank you
Call again

12-10-85
  123456

      X
201 7.  E
    *16.80
202 3.  E
    *5.55
    10.  E  F
    *22.35  F
0 0
00.20  g
16-03

```

Sample Operation

Mode Lock: X, 201 [X] 299 [PLU]

"Z" is printed for RESET report

```

PLU 201  Item Count
          Sale Amount
PLU 201  Item Count
          Sale Amount
Total Item Count of all the PLUs read in this report
Total Sale Amount " " " " " " " "

```

ALL PLU READ or RESET

Mode Lock: X for READ] depress [PLU].
Mode Lock: Z for RESET]

Reset Report Sample

Thank you
Call again

12-10-85
123456

	Z	
20.1	7.	¥
	*16.80	
20.2	3.	¥
	*5.55	
30.1	15.	¥
	*2.40	
30.2	6.	¥
	*3.30	
50.2	3.	¥
	*87.40	
	34.	¥
	*115.45	¥

PLU 201 Item Count
Sale Amount

PLU 202

:

Total Item Count] of all the PLUs
Total Amount

Reset Counter (not print on READ report)

0000.1Z
00.21
16-03

INDIVIDUAL DEPARTMENT READ

Mode Lock: X, Depress the required Department Key(s),
 (depress [ST] to obtain subtotal),
 depress [AT/TL] to end.

Thank you
 Call again

12-10-85
 123456

Sample Operation

Mode Lock: X

01*	X	4	SS	Dept.1	Customer Count
		7	TE		Item Count
		*26.40			Sale Amount
02*		3	SS	Dept.2	
		15	TE		
		*53.90			
		22	TE	[]	Subtotal (Dept.1 + Dept.2)
		*80.30	ST		
03*		2	SS	Dept.3	
		22	TE		
		*14.84			
04*		2	SS	Dept.4	
		14	TE		
		*14.00			
05*		1	SS	Dept.5	
		7	TE		
		*100.20			
		43	TE	[]	Subtotal (Dept.3+Dept.4+Dept.5)
		*129.04			
		65	TE	[]	Total Data of all the Depts.
		*209.34	TL		read in this report

[DEPT 1]

[DEPT 2]

[ST]

[DEPT 3]

[DEPT 4]

[DEPT 5]

[ST]

[AT/TL]

0 3
 00.22
 16-03

Thank you
Call again

12-10-85
123456

	X 12	
01*	15. %	
	*3.96	
02*	18. %	
	*9.70	
03*	22. %	
	*3.26	
04*	17. %	
	*2.38	
05*	10. %	
	*10.02	
06*	16. %	
	*1.44	
07*	19. %	
	*2.37	
08*	8. %	
	*1.20	
09*	9. %	
	*2.26	
	*36.59	F

Dept.1 Gross Profit Preset Rate 15%
Gross Profit Amount
Dept.2
:

Gross Profit Amount Total of All Depts.

03
00.23
16.-03

HOURLY READ or RESET

Mode Lock: X for READ] enter 10, depress [AT/TL]
Mode Lock: Z for RESET

Reset Report Sample

Thank you
Call again

12-10-85
123456

Z10

08-00

3. C
75. I

*275.06

16-00

3. C
5. I

*11.48

23-00

0000.2Z

00.24

16-04

8:00 to 16:00 Sales Data:

Customer Count

Item Count

Sale Total

16:00 to 23:00 Sales Data:

Customer Count

Item Count

Sale Total

23:00 to 24:00 (No sales-data recorded in this hourly range)

Reset Report Counter (Not print on READ report)

INDIVIDUAL CLERK READ or RESET

Mode Lock: X for READ] enter 1, depress [AT/TL]
 Mode Lock: Z for RESET]

Clerk 1 Reset Report Sample

Meanwhile, the required Clerk's Key must be set to ON.

Thank you
Call again

12-10-85
123.456

Z

10**

	78.	EM	CS
*	291.40	EM	CS
	80.	EM	NS
*	266.84	EM	NS
	80.	EM	NS
*	286.54	EM	NS
	6.	CS	TL
*	224.44	CKCA	TL
*	216.16	ID	TL
*	10.00	ID	TL
1	-3.54	PO	TL
2	*62.10	PO	TL
	*14.50	TX	
	*19.70	TX	

1000.22
00.25
16-04

Clerk ID
 Gross Sale Item Count
 " Amount
 Net Sale Item Count
 " Amount] Net Sale Without Tax (Print/Non-print Option)
 Net Sale Item Count
 " Amount] Net Sale With Tax (Print/Non-print Option)
 Total Customer Count
 All Media Total
 Cash-in-drawer Total
 Check-in-drawer Total
 Negative Data 1 (NEG 1) = (%- on Items) + (Negative Depts) + VD1*
 Negative Data 2 (NEG 2) = (%- on Subtotals) + (Dollar Discount) + VD2**
 Paid Out Total
 Tax Total
 Reset Report Count (Not print on READ report)

NOTES: * VD1 = Item Correction on Positive Dept Items
 ** VD2 = Item Correction on other items

AUTO READ or RESET

Mode Lock: X for READ] depress [AT/TL]
Mode Lock: Z for RESET

Reset Report Sample

Thank you
Call again

12-10-85
123456

Z
*287.20 GT

80. IM GS
*287.20 GS

01* 4. IM GS

7. IM
*26.40

9.74

02* 3. IM GS

15. IM
*53.90

19.89

03* 2. IM GS

22. IM
*14.84

5.48

04* 2. IM GS

14. IM
*14.00

5.17

05* 2. IM GS

4.61

08* 1. IM GS

2. IM
*15.00

5.53

09* 1. IM GS

3. IM
*25.20

9.30

10* 1. IM GS

-2. IM
-4.20

Grand Total (Non-resettable)

Gross Sale Item Count

" Amount

Dept.1 Customer Count

Item Count

Sale Amount

Sale Portion (%)

Dept.2

Department Report

Department Report

-- To be continued --

		--- (%+ Count and Amount, if [%+] Key is installed)		Financial Report
	80.	ITM	NS	Net Sale Item Count
1	*266.84			" Amount [Net Sale Without Tax; Non-print option]
	*19.70	TX	NS	Tax 1 Total
	80.	ITM	NS	Net Sale Item Count
	*286.54			" Amount [Net Sale With Tax; Non-print option]
	2.			Dollar Discount Count
	*4.00			" Amount [(- [on Subtotal) Count & Amount if [-] Key is installed)
	6.	CUS	TL	Total Customer Count
	*224.44			All Media Sales Total
	4.	CUS	CA	Cash Customer Count
	*212.96			Cash Sales Total
	1.	CUS	CK	Check Customer Count
	*7.70			Check Sales Total
	1.	CUS	CH	Charge Customer Total
	*3.78			Charge Sales Total
	0.	CUS	MS	Misc. Customer Total
	*0.00			Misc. Sales Total
	2.	MS	R/A	Received-on-Account Count
	*25.00			" Amount
	2.	PO	R/A	Paid-Out Count
	*14.50			" Amount
	*216.16	CA	ID	Cash-in-drawer Amount
	1.	CK	ID	Check-in-drawer Count
	*10.00			" Amount (Non-print Option)
	1.	CH	ID	Charge-in-drawer Count
	*3.78			" Amount (Non-print Option)
	3.	VD	ID	VD1 (Item Correct on Positive Dept Items) Count
	*8.16			" " Amount
2	2.	VD	ID	VD2 (Item Correct on other items) Count
2	*7.50			" " Amount
	2.	EM		Negative Depts Item Count Total
	-4.20			" " Amount Total [(- [on Dept. or PLU Items] Count & Amount if [-] Key is installed)
	2.	R/M		Returned Merchandise Item Count
	*8.05			" " Amount
2	0.	R/M		Negative Mode Count
2	*0.00			" " Amount
	*0.00	TL	TF	Accumulated Transfer Balance
	*0.00			" Transfer Positive Non-resettable
	*0.00			" Transfer Negative
2	*0.00	TF		Daily Transfer Positive
2	*0.00	TF		Dialy Transfer Negative
	0.	CUS		Previous Balance Customer Count
	*0.00			Previous Balance Total
	*0.00	R/A		Previous Balance Payment Received
	*0.00	PO		Previous Balance Paid Back to Customers

1	*197.00	TX FL
1	1	CUS
1	*9.00	
2	*0.00	
3	*0.00	
	2	NS
2	6	
1 0 **		
	0	ITM
	*0.00	GS GS
	0	ITM
	*0.00	NS NS
	0	ITM
	*0.00	NS NS
	0	CUS
	*0.00	TL TL
	*0.00	CK CA
	*0.00	ID ID
1	-3.54	
2	*62.10	
	*14.50	
	*19.70	TX
01*	15.	%
	*3.96	
02*	18.	%
	*9.70	
03*	22.	%
	*3.26	
04*	17.	%
	*2.38	
05*	10.	%
	*10.02	
06*	16.	%
	*1.44	
07*	19.	%
	*2.37	
08*	8.	%
	*1.20	
09*	9.	%
	*2.26	
	*36.59	FL
2 0 0 0.1 Z		
0 0.2 6 0		
1 6 - 0 4		

Taxable Total 1
 Tax 1 Exemption Customer Count
 Sale Amount Subject to Tax 1 Exemption
 " 2
 " 3] Prints only when multi-tax
 No-sale Count
 Validation Count

Clerk Report (Refer to CLERK READ or RESET on page 41.)

Department Gross Profit Report
 (Refer to DEPARTMENT GROSS PROFIT READ on page 39.)

Print or Non-print of this portion in the AUTO READ/RESET REPORT is a programmable option.

Reset Report Counter (Not print on READ report)

AUTO GT READ or RESET

DEPARTMENT GROSS PROFIT GT READ

Mode Lock: X for READ] enter 20,
Mode Lock: Z for RESET depress [AT/TL]

Mode Lock: X, enter 22, depress [AT/TL]

The data of these reports are data of corresponding daily reports accumulated since the last AUTO GT-RESET report taking. Except the Report Headers shown below and except that some total item memories are not provided in these GT reports, the print items and forms are same with their corresponding daily read/reset reports.

Thank you
Call again

12-10-85
⊘123456

** Z20

Thank you
Call again

12-10-85
⊘123456

**X 22

PAPER ROLL REPLACEMENT AND OTHER MAINTENANCE OPERATIONS

Journal
Winding
Reel

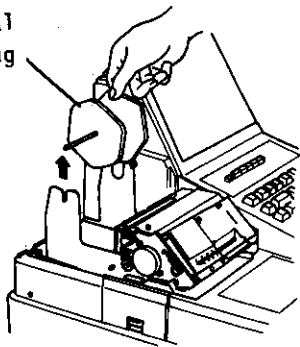

Fig. 1

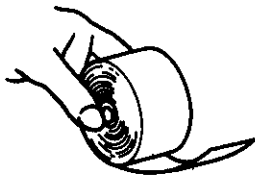

Fig. 2



Fig. 3

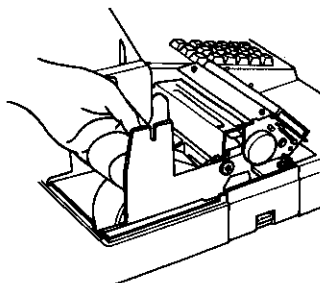

Fig. 4

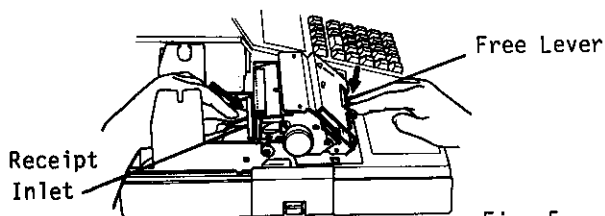

Fig. 5

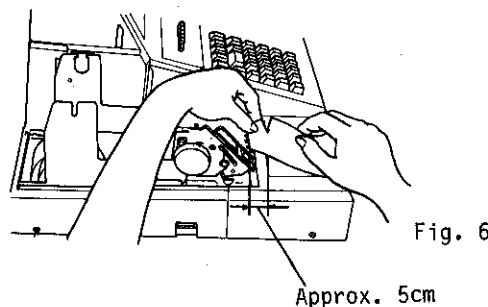

Fig. 6

Approx. 5cm

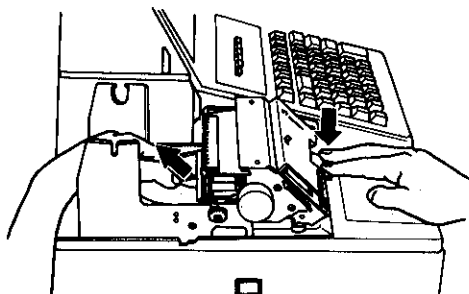

Fig. 7

INSTALLING THE RECEIPT PAPER

1. Turn the Mode Lock to the "REG" position with the power on.
2. Remove the Paper Cover by pulling it upward, and remove the Journal Winding Reel (Fig. 1).
3. Hold a new paper roll in the direction as shown in Fig. 2 so that the paper end will be fed from the bottom.
4. Fold the paper end firmly as shown in Fig. 3 to ease the insertion.
5. Place the paper roll in the outer-side holder of the two roll holders (Fig. 4).
6. Insert the paper end into the Receipt Inlet, feed the paper in while pressing down the Free Lever (or feed the paper in while pressing the [RF] key). (Fig. 5)
7. When all the folded portion comes out, tear off the unnecessary part with an appropriate end length remaining (approx. 5cm or 2 inches). (Fig. 6)
8. Go on to INSTALLING THE JOURNAL PAPER steps if necessary, or go on to Step 9 below if not.
9. Attach the Paper Cover. Meanwhile, the paper end must be seen outside the cover.
10. Press the [C] key to clear the paper-end condition, and depress the [NS] key and cut the issued receipt to check if the paper has properly been set.

REMOVING THE RECEIPT PAPER

1. Remove the Paper Cover by pulling it upward (Fig. 1).
2. Press the Free Lever down and pull the old paper core upward to remove the remaining paper end (Fig. 7).

INSTALLING THE JOURNAL PAPER

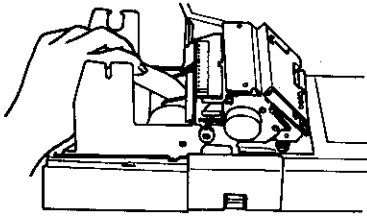

Fig. 8

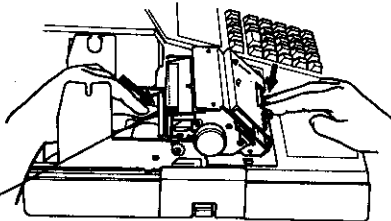

Fig. 9

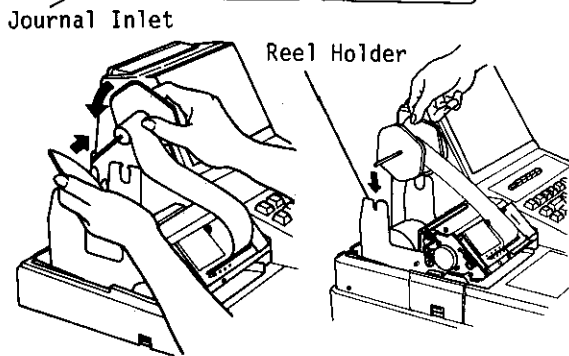

Fig. 10

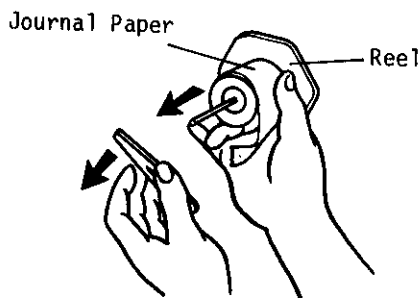

Fig. 11

1. Turn the Mode Lock to the "REG" position with the power on.
2. Remove the Paper Cover by pulling it upward, and remove the Journal Winding Reel. (Fig. 1 on the previous page)
3. Follow Steps 3 and 4 of INSTALLING THE RECEIPT PAPER on the previous page.
4. Place the paper roll in the inner-side roll holder of the two holders. (Fig. 8)
5. Insert the paper end into the Journal Inlet, feed the paper in while pressing down the Free Lever (or feed the paper in while pressing the [JF] key). (Fig. 9)
6. When the paper comes out for an enough length, wind the paper end on the Journal Winding Reel two or three times, and set the Journal Winding Reel to the Reel Holder. (Fig. 10)
7. Attach the Paper Cover.
8. Press the [C] key before starting operation.

REMOVING THE JOURNAL PAPER

1. Remove the Receipt Cover by pulling it upward (Fig.1 on the previous page).
3. Press the [JF] key to wind up enough portion of the journal paper, and then tear off the paper, holding the Journal Winding Reel.
2. The wound-up portion of the paper can easily be removed from the Reel by pulling it side way (Fig. 11).
4. If enough paper remains on the roll, follow Steps 6 through 8 above; if paper is running out, follow Steps 1 through 8 above.

REPLACING THE INK ROLL

When the receipt and journal print is too light, replace the ink roll in the following manner.

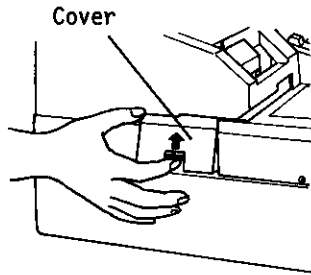

Fig. 1

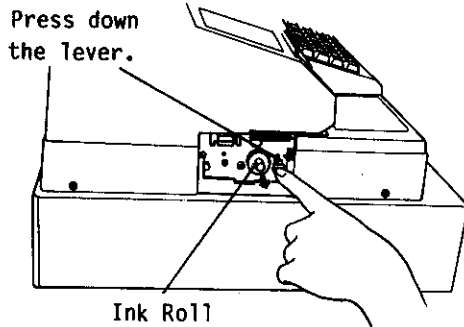

Fig. 2

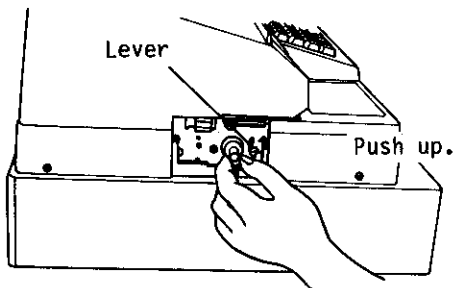

Fig. 3

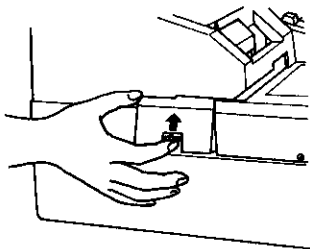

Fig. 4

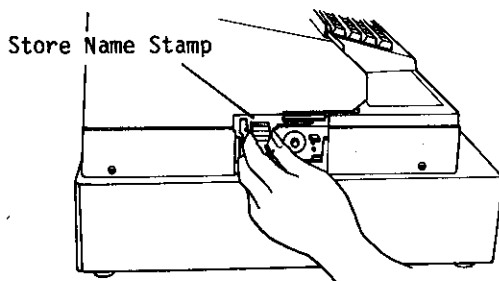
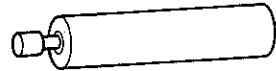

Fig. 5

1. Turn the Power Switch to OFF.
2. Remove the cover located on the lefthand side of the cabinet, by lifting it up, as shown in Fig. 1.
3. Press down the lever, and withdraw the Ink Roll. (Fig. 2)
4. Insert a new Ink Roll into the hole, push it all the way in, and push up the lever. (Fig. 3)
5. Attach the cover, by inserting the top edge first and pressing the bottom part next. (Fig.4)

NOTE: The Ink Roll is a consumable product. Please order it to your TEC representative when necessary.



REPLENISHING THE STORE NAME STAMP WITH INK

When the store name stamp is printed too lightly, replenish the ink in the following manner.

1. Turn the Power Switch to OFF.
2. To remove the cover, follow Step 2 above.
3. Withdraw the store name stamp with the protruding part pinched with your fingers. (Fig.5)
4. Apply ink on the pad on the rear side of the Store Name Stamp. The amount of the refilling should be adjusted according to the density of the printed message, but the limit of 2 cc should not be exceeded. (The ink bottle supplied contains 5 cc of ink.) (Fig. 6)
5. Follow Step 5 above to attach the cover, after setting the stamp to the original position.

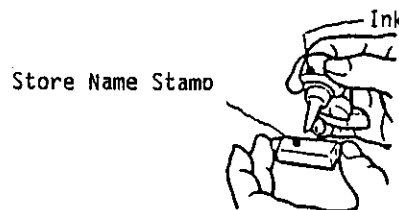
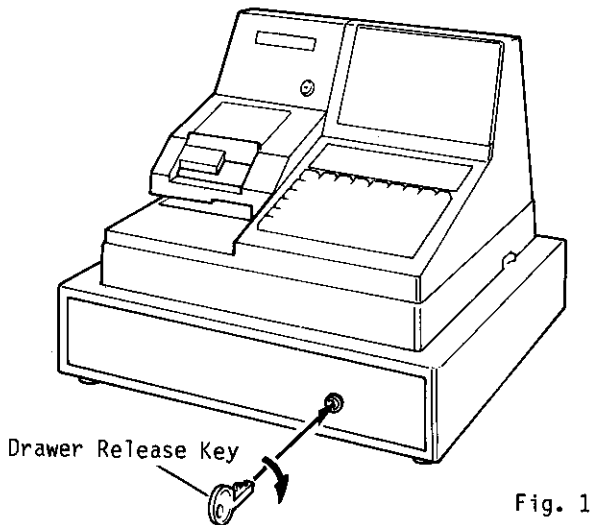

Fig. 6

MANUAL DRAWER RELEASE AND LOCK

Releasing the Drawer

The drawer opens automatically when a registration is made. In the event of a power failure or other troubles, the drawer can be opened in the following manner.



- 1) Insert the Drawer Release Key into the drawer release lock and turn the key 45 degrees clockwise. The drawer will now open. (Fig. 1)
- 2) The Drawer Release Key can be taken out by returning it to the original position.
- 3) When the drawer is closed, it is automatically locked and will not open without the Drawer Release Key.

Removing the Drawer

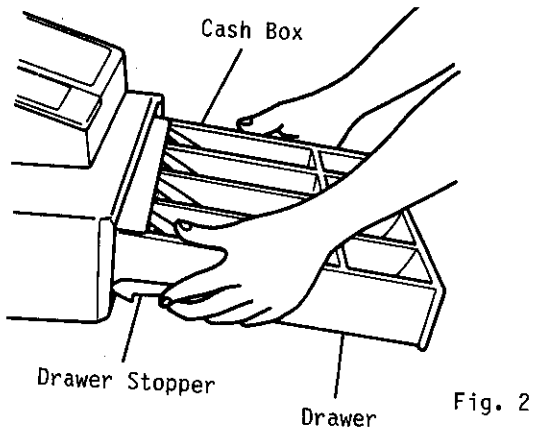

- 1) To remove the drawer, lift it up by the stoppers attached on both sides and pull it out. (Fig. 2)
- 2) When installing the drawer, fit its rollers onto the rails of the register and push it all the way in. (Fig. 2) The coin case can be removed from the drawer, by lifting it up at the front.

CDC (Cash Drawer Cover) LOCK (Fig. 3)

Locking

Push the Cash Drawer Cover to the drawer-end plate so that the arrowed parts of the cover go under and the rest parts go over the plate.

Press the cover lightly, insert the key into the key-hole on the cover, and turn clockwise. Now the cover is locked.

Opening

Release the lock by the key, and lift up the cover tip.

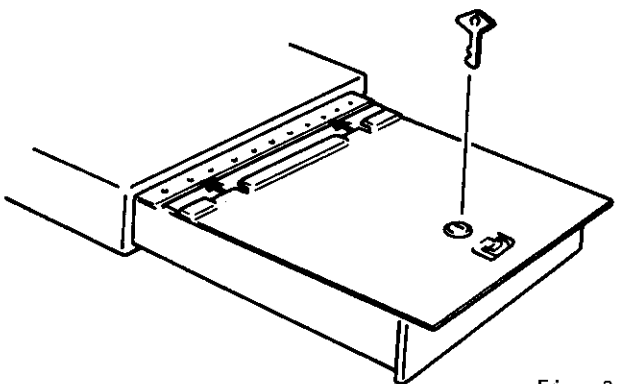

PAPER END DETECTION

When the receipt or journal paper ends, the displayed data will flicker to inform the cashier of the paper-end condition, when no key operations will be accepted. In this condition, immediately replace the paper roll with a new one. After setting the new roll properly, depress the [C] key to release the paper-end condition. The [RF] and [JF] keys are operative even in the paper-end condition.

WHEN A POWER FAILURE OCCURS ...

If a power failure occurs, all sales data stored in the memory are automatically protected by the battery installed in the ECR. The battery is rechargeable and it is recharged when the AC power returns. As the power returns, the register revives to continue the work. However, on the recovery of a power failure, please check the receipt before it is handed to the customer.

HARDWARE OPTIONS AVAILABLE

The following hardware devices are available as options.

PLU KEYBOARD

It has 130 keys, each of which corresponds to a PLU code. By simply depressing a key, the "PLU Code+ [PLU]" entry sequence is made. Thus this simplifies PLU operations and saves time. The PLU Keyboard will be connected to the ECR with a 1m straight cable and may be placed on the cashier counter table near the ECR.

REMOTE SLIP PRINTER

By connecting it, required transactions will be recorded on the remote slip as well as on the receipt and the journal rolls.

SPECIFICATIONS

Size	460mm(width)x400mm(depth)x369mm(height) (with SP drawer) 397mm(width)x423mm(depth)x366mm(height) (with MIDI drawer)
Weight	18.5 kg (with SP drawer) 17 kg (with MIDI drawer)
Power Required	AC 117V \pm 10% (Varies depending on the destination.)
Power Consumed	8W non-operating, 31W operating
Ambinet Temperature	0°C to 40°C, 10% to 90% RH

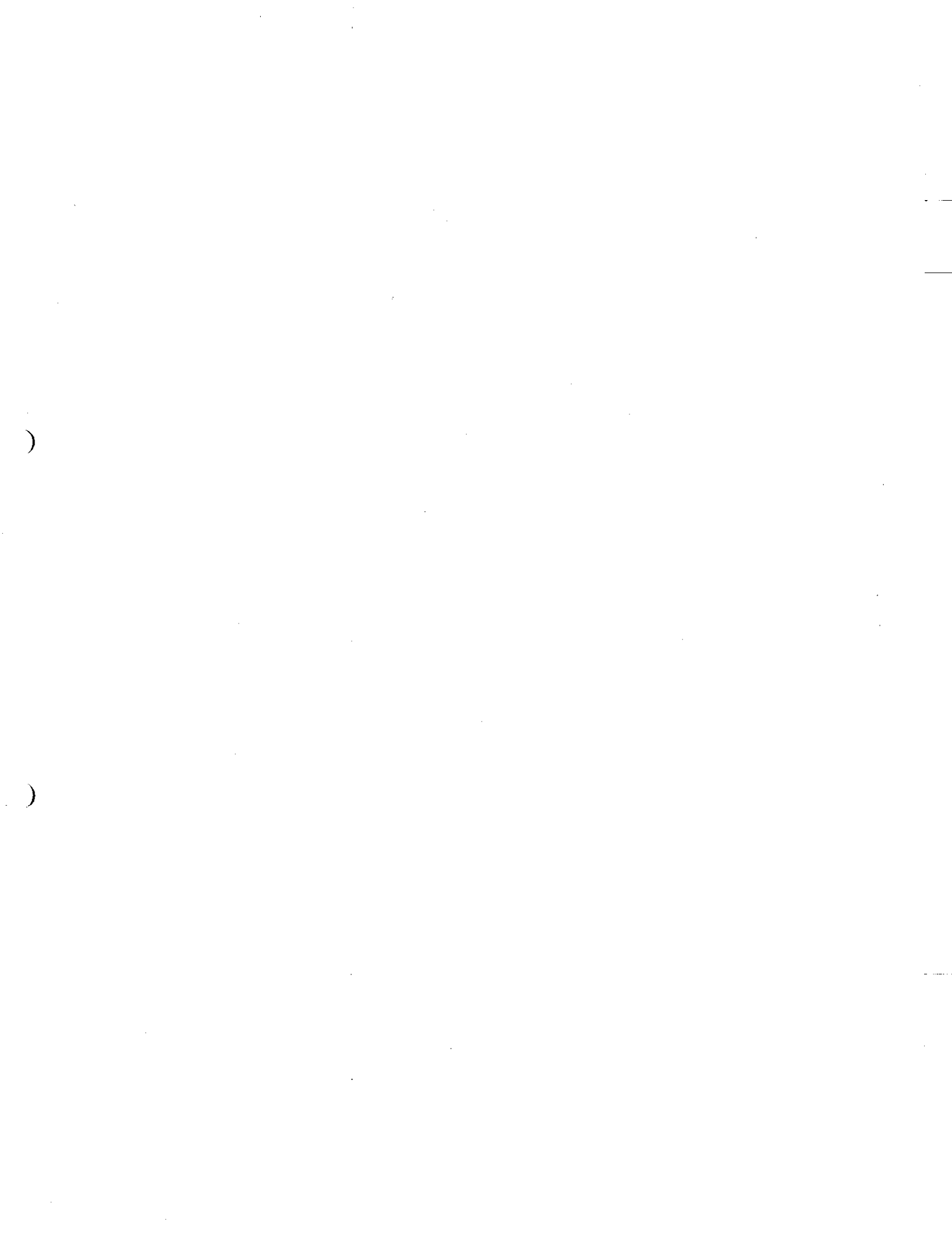

—
—
—

)

,

—