

TEC Electronic Cash Register

MA-156-1 SERIES

Owner's Manual

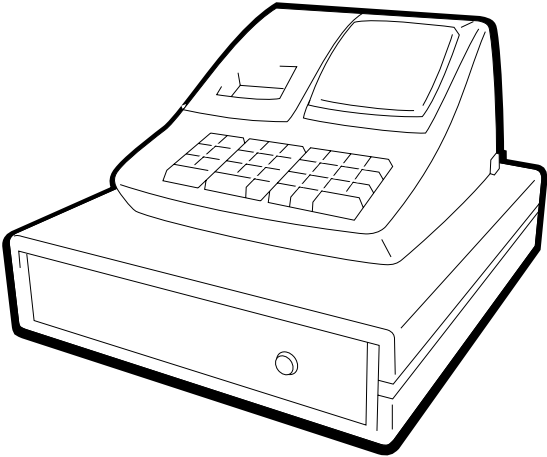

NOTICE

This equipment has been tested and found to comply with the limits for a Class A digital device, pursuant to Part 15 of the FCC Rules. These limits are designed to provide reasonable protection against harmful interference when the equipment is operated in a commercial environment. This equipment generates, uses, and can radiate radio frequency energy and, if not installed and used in accordance with the instruction manual, may cause harmful interference to radio communications. Operation of this equipment in a residential area is likely to cause harmful interference in which case the user will be required to correct the interference at his own expense. Changes or modifications not expressly approved by manufacturer for compliance could void the user's authority to operate the equipment.

WARNING

"This Class A digital apparatus meets all requirements of the Canadian Interference-Causing Equipment Regulations."

"Cet appareil numérique de la classe A respecte toutes les exigences du Règlement sur le matériel brouilleur du Canada."

Safety Summary

Personal safety in handling or maintaining the equipment is extremely important. Warnings and Cautions necessary for safe handling are included in this manual. All warnings and cautions contained in this manual should be read and understood before handling or maintaining the equipment.

Do not attempt to effect repairs or modifications to this equipment. If a fault occurs that cannot be rectified using the procedures described in this manual, turn off the power, unplug the machine, then contact your authorized TOSHIBA TEC representative for assistance.

Meanings of Each Symbol



This symbol indicates warning items (including cautions). Specific warning contents are drawn inside the \triangle symbol. (The symbol on the left indicates a general caution.)



This symbol indicates prohibited actions (prohibited items). Specific prohibited contents are drawn inside or near the \circ symbol. (The symbol on the left indicates "no disassembling".)













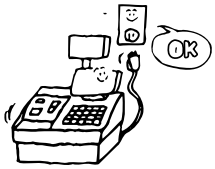

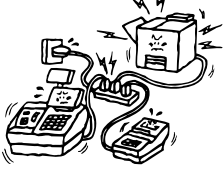





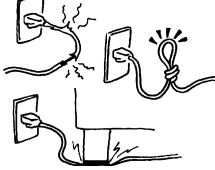

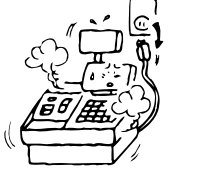

This symbol indicates actions which must be performed. Specific instructions are drawn inside or near the \bullet symbol. (The symbol on the left indicates "disconnect the power cord plug from the outlet".)

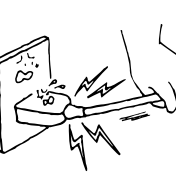

WARNING

This indicates that there is the risk of **death** or **serious injury** if the machines are improperly handled contrary to this indication.

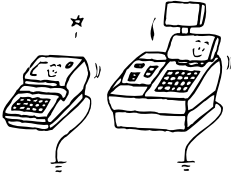
| | |
|--|---|
|  <p>Prohibited</p>  <p>■ Do not plug in or unplug the power cord plug with wet hands as this may cause electric shock.</p> |  <p>Any other than the specified AC voltage is prohibited.</p>  <p>■ Do not use voltages other than the voltage (AC) specified on the rating plate, as this may cause fire or electric shock.</p> |
|  <p>Prohibited</p>  <p>■ If the machines share the same outlet with any other electrical appliances which consume large amounts of power, the voltage will fluctuate widely each time these appliances operate. Be sure to provide an exclusive outlet for the machine as this may cause the machines to malfunction.</p> |  <p>Prohibited</p>  <p>■ Do not place metal objects or water-filled containers such as flower vases, flower pots or mugs, etc. on top of the machines. If metal objects or spilled liquid enter the machines, this may cause fire or electric shock.</p> |
|  <p>Prohibited</p>  <p>■ Do not insert or drop metal, flammable or other foreign objects into the machines through the ventilation slits, as this may cause fire or electric shock.</p> |  <p>Prohibited</p>  <p>■ Do not scratch, damage or modify the power cords. Also, do not place heavy objects on, pull on, or excessively bend the cords, as this may cause fire or electric shock.</p> |
|  <p>Disconnect the plug.</p>  <p>■ If the machines are dropped or their cabinets damaged, first turn off the power switches and disconnect the power cord plugs from the outlet, and then contact your authorized TOSHIBA TEC representative for assistance. Continued use of the machine in that condition may cause fire or electric shock.</p> |  <p>Disconnect the plug.</p>  <p>■ Continued use of the machines in an abnormal condition such as when the machines are producing smoke or strange smells may cause fire or electric shock. In these cases, immediately turn off the power switches and disconnect the power cord plugs from the outlet. Then, contact your authorized TOSHIBA TEC representative for assistance.</p> |

| | |
|--|---|
|  <p>Disconnect the plug.</p>  <p>■ If foreign objects (metal fragments, water, liquids) enter the machines, first turn off the power switches and disconnect the power cord plugs from the outlet, and then contact your authorized TOSHIBA TEC representative for assistance. Continued use of the machine in that condition may cause fire or electric shock.</p> |  <p>Disconnect the plug.</p>  <p>■ When unplugging the power cords, be sure to hold and pull on the plug portion. Pulling on the cord portion may cut or expose the internal wires and cause fire or electric shock.</p> |
|  <p>Connect a grounding wire.</p>  <p>■ Ensure that the equipment is properly grounded. Extension cables should also be grounded. Fire or electric shock can occur on improperly grounded equipment.</p> |  <p>No disassembling.</p>  <p>■ Do not remove covers, repair or modify the machine by yourself. You may be injured by high voltage, very hot parts or sharp edges inside the machine. Unauthorized modification is prohibited.</p> |



CAUTION This indicates that there is the risk of personal **Injury** or **damage** to objects if the machines are improperly handled contrary to this indication.

Precaution

The following precautions will help to ensure that this machine will continue to function correctly.

- Try to avoid locations that have the following adverse conditions:
 - * Temperatures out of the specification
 - * Direct sunlight
 - * High humidity
 - * Shared power socket
 - * Excessive vibration
 - * Dust/Gas
- Do not subject the machine to sudden shocks.
- Do not press the keys too hard. Keys will operate correctly if they are touched lightly.
- Clean the cover and keyboard, etc. by wiping with a dry cloth or a cloth soaked with detergent and wrung out thoroughly. Never use thinner or other volatile solvent for cleaning.
- At the end of the day, turn the power OFF, then clean and inspect the exterior of the machine.
- Try to avoid using this equipment on the same power supply as high voltage equipment or equipment likely to cause mains interference.
- USE ONLY TOSHIBA TEC SPECIFIED consumables.
- DO NOT STORE the consumables where they might be exposed to direct sunlight, high temperatures, high humidity, dust, or gas.
- When moving the machine, take hold of the drawer and lift the machine.
- Do not place heavy objects on top of the machines, as these items may become unbalanced and fall causing **injury**.
- Do not block the ventilation slits of the machines, as this will cause heat to build up inside the machines and may cause **fire**.
- Do not lean against the machine. It may fall on you and could cause **injury**.

Request Regarding Maintenance

- Utilize our maintenance services.

After purchasing the machines, contact your authorized TOSHIBA TEC representative for assistance once per year or so to have the inside of the machines cleaned. Otherwise, dust will build up inside the machines and may cause **fire** or **malfunction**. Cleaning is particularly effective before humid rainy seasons.

- Our maintenance service performs the periodic checks and other work required to maintain the quality and performance of the machines, preventing accidents beforehand.

For details, please consult your authorized TOSHIBA TEC representative for assistance.

- Using insecticides and other chemicals

Do not expose the machines to insecticides or other volatile solvents, as this will deteriorate the cabinet or other parts or cause the paint to peel.

TABLE OF CONTENTS

| | Page |
|--|------|
| 1. Introduction | 1 |
| 2. Unpacking | 2 |
| 3. Outline of Preparation Procedure Before Operating the ECR | 3 |
| 4. Appearance and Nomenclature | 5 |
| 5. Mode Select Switch | 5 |
| 6. Display | 6 |
| 7. Keyboard | 7 |
| Functions of Each Key | 7 |
| 8. Installing the Paper Roll | 9 |
| 9. Programming | 11 |
| System Option Setting | 12 |
| Department Status Setting | 14 |
| Time Setting | 15 |
| Date Setting | 15 |
| Department HALC Setting | 16 |
| Secret Code Setting | 17 |
| % Rate Setting | 17 |
| PLU Setting | 18 |
| PLU Deletion | 19 |
| Amount Format Setting | 19 |
| Tax Table Setting | 20 |
| 10. Verification of Programmed Data | 24 |
| 11. Daily Operation Flow | 25 |
| 12. Transaction Entries | 26 |
| When an error has occurred | 26 |
| Displaying the Time | 26 |
| No-sale | 27 |
| Sale Item Entries (Department Entries) | 27 |
| Sale Item Entries (PLU Entries) | 28 |
| Dollar Discount | 30 |
| Percent Discount or Percent Charge | 30 |
| Void | 31 |
| Returned Merchandise | 31 |
| Non-add Number Print | 32 |
| Subtotal Read and Print | 32 |
| Finalizing a Sale | 32 |
| Tax Exemption | 35 |
| Received-on-Account Payment | 35 |
| Paid Out | 35 |
| 13. Read (X) and Reset (Z) Reports | 39 |
| 14. Maintenance | 39 |
| Replacing the Paper Roll | 39 |
| Replacing the Ink Roller | 40 |
| Manual Drawer Release | 40 |
| Removing the Drawer | 41 |
| Battery Exchange | 41 |
| 15. Specifications | 42 |

CAUTION:

1. *This manual may not be copied in whole or in part without prior written permission of TOSHIBA TEC.*
2. *The contents of this manual may be changed without notification.*
3. *Please refer to your local Authorized Service representative with regard to any queries you may have in this manual.*

1. Introduction

Thank you for choosing the MA-156 series. This instruction manual provides a description of the functions and handling of this register and should be read carefully to ensure optimum performance. Since every consideration has been given to safety and reliability, there is no danger of damaging the machine by incorrect operation.

Please refer to this manual whenever you have any questions concerning the machine. This machine has been manufactured under strict quality control and should give you full satisfaction. However, if the machine is damaged during transit, or there are any unclear points in this manual:

For supplies, service or assistance call:

Please have the following information available when you call:

| | |
|-------------------|--------------------------|
| Product: | Electronic Cash Register |
| Model: | MA-156-1 |
| Serial Number: | _____ |
| Place Purchased: | _____ |
| Date of Purchase: | _____ |

If for any reason this product is to be returned to the store where purchased, it must be packed in the original carton.

- The specifications described in this manual may be modified by the manufacturer, if necessary.
- Be sure to keep this manual for future reference.

2. Unpacking

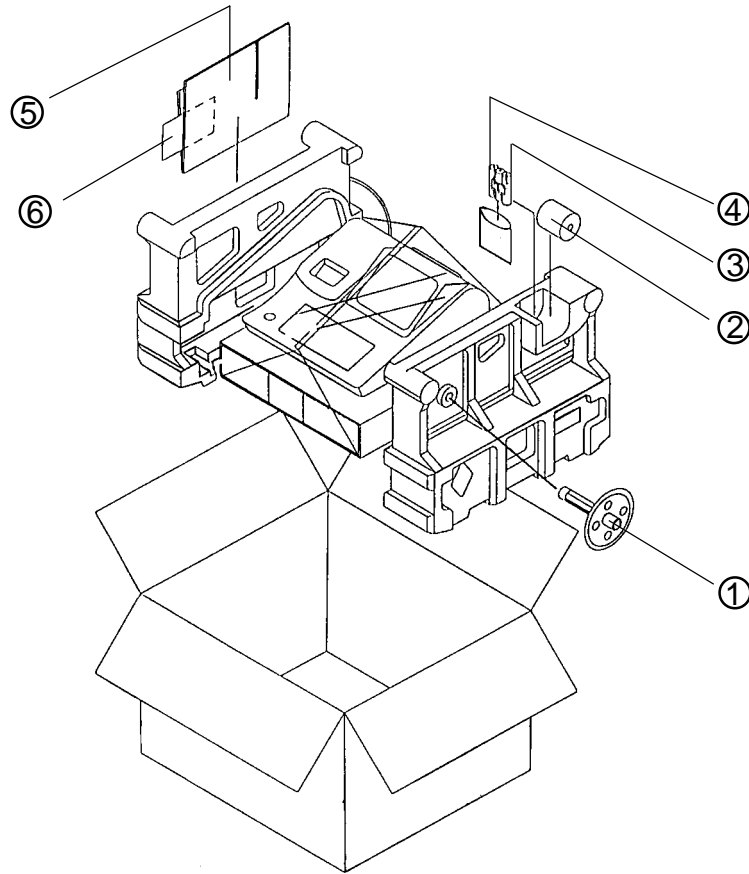

① Journal Take-up Reel (1 pc.)

② Paper Roll 57 mm x \varnothing 50 mm (1 pc.)

③ Dry Batteries (SUM-3 1.5V; 3 pcs.)

④ Printer Cover/Drawer Key (2 pcs.)

⑤ Owner's Manual (1 pc.)

⑥ Warranty Registration Card (1 pc.)

3. Outline of Preparation Procedure Before Operating the ECR

This chapter shows the outline of set-up procedure of the ECR before actually starting the ECR operation.

- 1 Remove the cash register from the carton, referring to Chapter "2. Unpacking" on page 2. And take out all the parts and accessories.

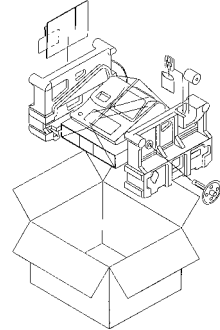

- 2 Remove the tapes and seals that are holding parts or protecting the register surfaces.

- 3 Plug the power cord of the register into a wall outlet. Make sure that the outlet voltage matches that of the power required for the register.

WARNING: *Be sure to plug in the power cord first, then insert the batteries.*

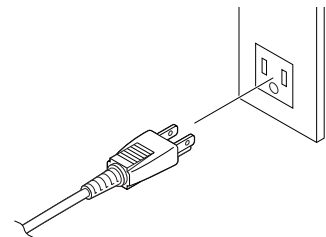

- 4 Detach the Printer Cover and the Battery Cover, then insert the batteries (3 pieces). After inserting the batteries, attach the Battery Cover.

WARNING: *Be certain to insert the batteries enclosed in the package. If they are not insert and the power is turned OFF (including a power failure occurrence), the sales data and the programmed data will be cleared.*

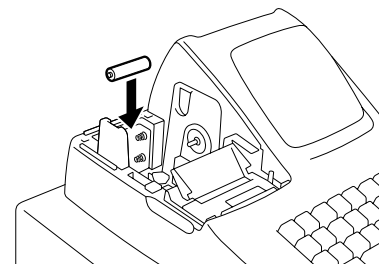

- 5 Set the Mode Select Switch to the **REG** position.

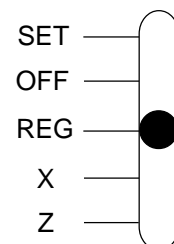

- 6 Install the Receipt or Journal roll (referring to Chapter "8. Installing the Paper Roll").

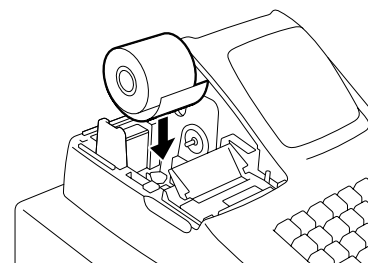

- 7 Set the time and date correctly, referring to "**Setting the Time and Date**" in Chapter 9.

- 8 Set the tax tables, referring to "**Tax Table Setting**" in Chapter 9.

- 9 Perform other programming operations, such as programming of Departments, according to the requirement of the market and your store (refer to Chapter 9 and thereafter).

4. Appearance and Nomenclature

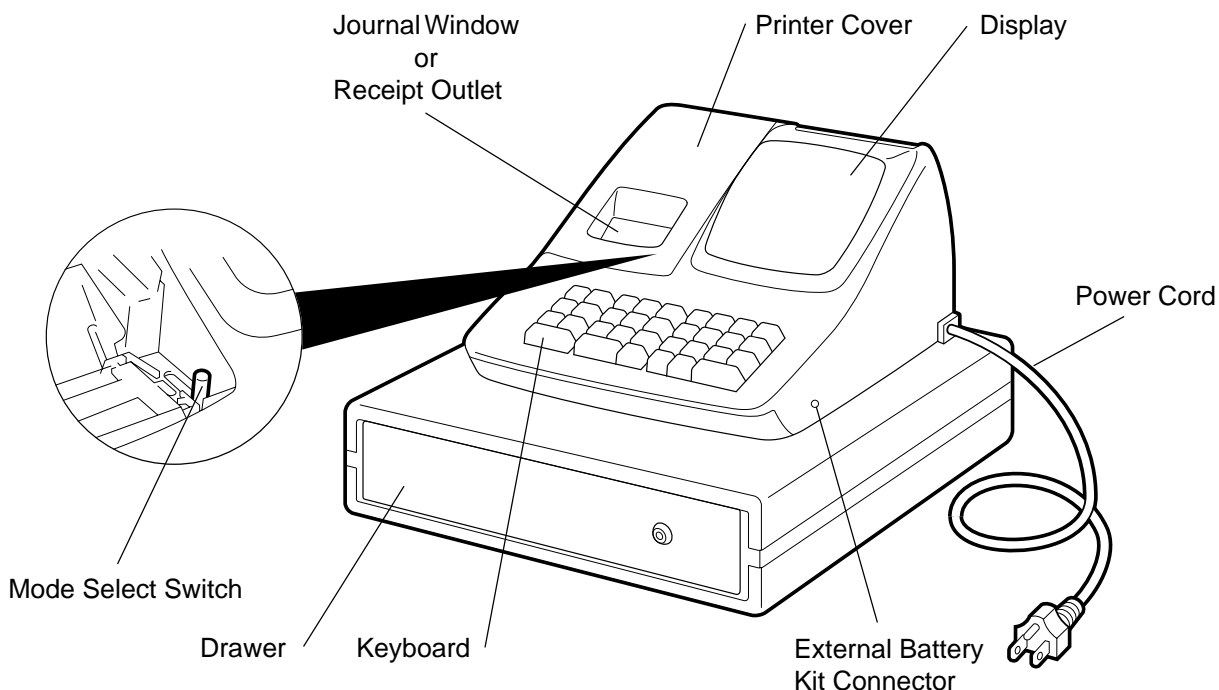

Printer Cover

The cover for the Receipt or Journal paper holder and the printer.

Display (Operator and Customer)

Used to confirm the entry contents and the status of the register. (page 6)

Receipt Outlet or Journal Window

The receipt for the finalized sale is issued. Or, the operator can see which items have already been entered through this window.

Mode Select Switch

The Mode Select Switch is provided inside the Printer Cover. It selects the type of register operations. (page 5)

External Battery Kit Connector

The External Battery Kit (K-BAP-QM) is available as an option. By connecting this kit into the connector, the register is operable without AC power.

Keyboard

Used to enter sale items. (page 7)

Drawer

Cash and other media are kept here. It automatically opens on finalizing a sale.

5. Mode Select Switch

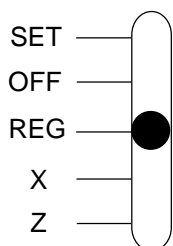

SET Used to program preset data.

OFF Stops register operations and extinguishes the display. However, the power is being supplied to the register.

REG Used to register normal sales .

X Used to read sales totals processed in the register report memory (X report). Received-on-Account and Paid Out operations are also performed in this position. Also used to read preset data.

Z Used to read and reset sales totals in the register report memory (Z report).

6. Display

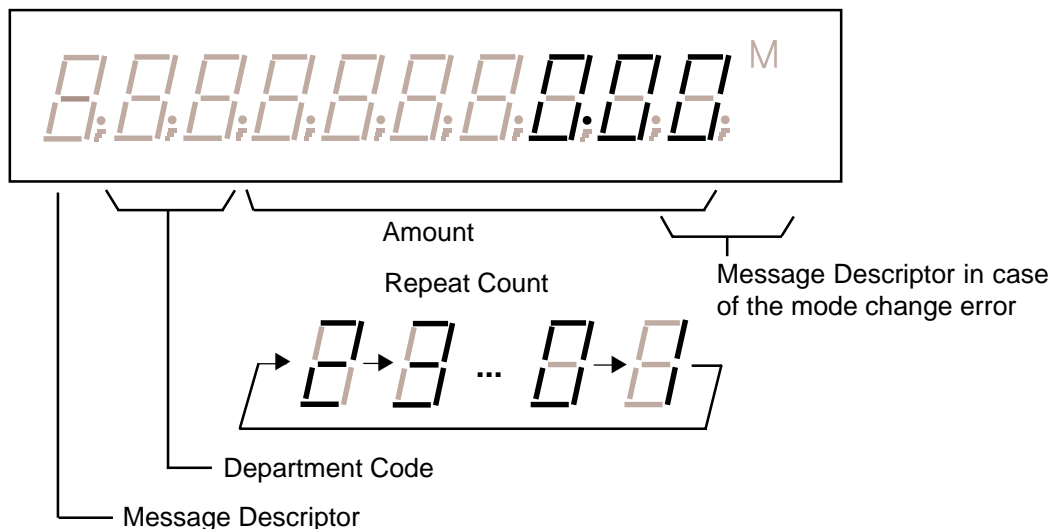



Description

Amount Displays the numeric data, such as amount, quantity, etc.
 Displays the current time or date when the [X/TIME] key is depressed in the REG mode.

Repeat Count Displays the repeat count of the same item being entered.
 The count display shows up from the second entry on, and only the last digit will be displayed even if the count exceeds nine.

Department Code Displays the Department Code (1 to 8) when the corresponding Department Key is depressed for any sale item entry.

Message Descriptor:  (Subtotal)
 Indicates that the displayed amount is the current subtotal of the sale.

 (Total)
 Indicates that the sale is finalized and the displayed amount is the sale total.

 (Change)
 Indicates that the sale is finalized with an amount tendered and the displayed amount is the change due.

 (Negative Mark)
 When a Void, Dollar Discount, Percent Discount, or Returned Merchandise item has been entered, the Negative Mark is displayed.
 The mark is also displayed when the subtotal or sale total is obtained and the amount is negative.



 (Error)
 Indicates that the last operation has caused an error.
 In case of the mode change error, "M" is displayed together with "E".



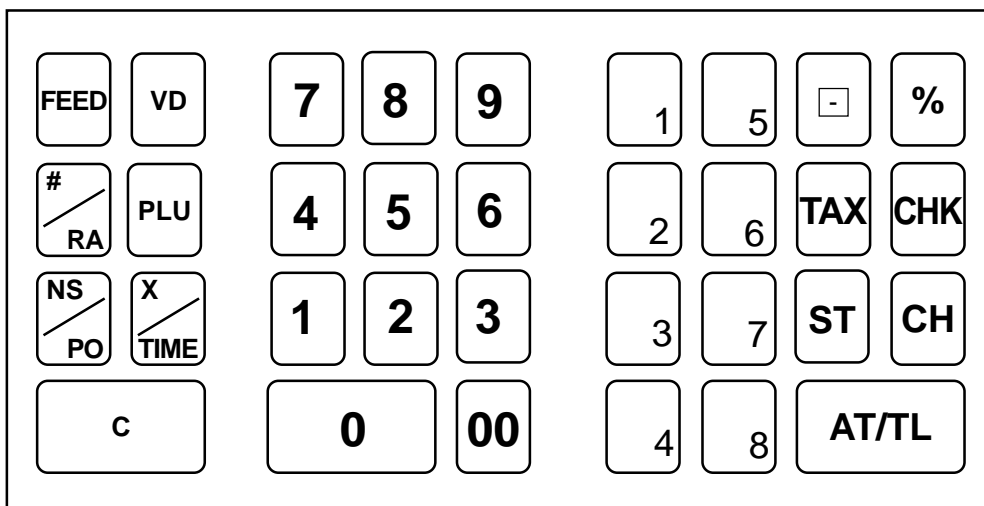





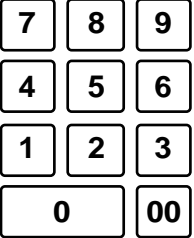
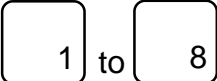

7. Keyboard

The following shows the key layout on the MA-156 keyboard:



Functions of Each Key

| KEY | FUNCTION |
|---|---|
|  | Clear Key: Used to clear a wrong entry or operation error. |
|  | Multiplication / Time Display Key: Used to enter sale items by multiplication inside a sale. Also used to display the time outside a sale. |
|  | Feed Key: Used to feed the receipt or journal paper. |
|  | Numeric Keys: Used to enter numeric data, such as amounts, quantities, and code numbers. The [00] key functions the same as depressing the [0] key twice consecutively. |
|  | Department Keys 1 to 8: Used to enter sale items and process the amount into appropriate departments. |

| KEY | FUNCTION |
|---|---|
|  | Tax Modifier: Used inside a sale to reverse the Tax status of departments, PLUs, Dollar Discount, and Percent Charge/Discount from taxable to non-taxable, or vice versa. |
|  | Percent Charge or Discount Key: Used to add or subtract a percent rate, preset or manually entered, to or from the sale or an individual sale item. Whether the key is used as Percent Charge or Percent Discount can be programmed. |
|  | Subtotal Key: Used to obtain a subtotal (sale total amount up to the moment). |
|  | Charge Key: Used to finalize a sale as charge (non-cash media sales, such as house charge, credit cards, etc. defined by the store) by a simple depression without any numeric entry (Total Function only). |
|  | Cash Amount Tender / Total Key: Used to finalize a sale as cash by depressing with a prior tendered amount entry (Tender Function) or by a simple depression without any numeric entry (Total Function). |
|  | Check Amount Tender/Total Key: Used to finalize a sale as check by depressing with a prior tendered amount entry (Tender Function) or by a simple depression without any numeric entry (Total Function). |
|  | Returned Merchandise/Void Key: Used inside a sale to delete items already entered in the current sale. When outside a sale, it is used to refund money to a customer who has returned items already purchased. |
|  | Non-add Number Print/Received-on-Account Key (X Mode): When depressed with a prior number entry, it function as Non-add Number Print Key. When used in X mode, it functions to record received-on-account payment amounts. |
|  | No-sale/Paid Out Key (X Mode): Used outside a sale to open the drawer without relating to a sale. When used in X mode, it functions to record amounts paid out of the drawer without relating to a sale. |
|  | PLU (Price-Look-Up) Key: Used to enter a PLU which is linked to a department. |
|  | Dollar Discount Key: Used to subtract an amount from the sale such as a discount. |

8. Installing the Paper Roll

WARNING!

Care must be taken not to injure yourself with the paper cutter.

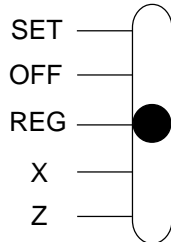

1

Set the Mode Select Switch to **REG** position.

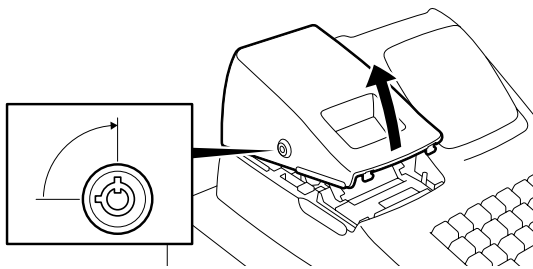

2

To remove the Printer Cover, insert the Printer Cover/Drawer Key to the Printer Cover Lock, and then Turn it 90° clockwise.

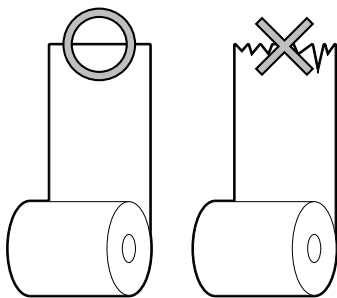

3

Cut the paper end to make it sharp.

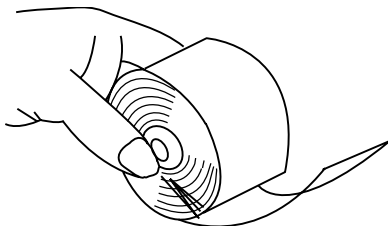

4

Hold the paper roll so that the paper end will be fed from the bottom.

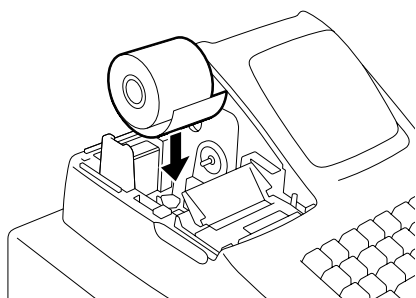

5

Place the paper roll in the paper pocket.

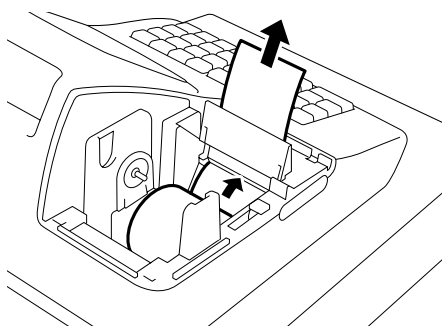

6

Insert the paper end into the Paper Inlet located on the rear side of the printer, and hold down the **[FEED]** key on the keyboard until the paper end comes out of the outlet.

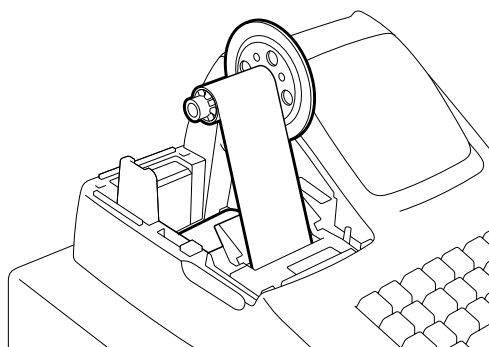

7

If the printer is used for journal, fold the top end of the paper and insert the folded end into the slit of the Take-up Reel. Then wind the paper two or three times, set the reel to the holder, and hold down the **[FEED]** key for a while to tense the paper.

If the printer is used for receipts, do not wind the paper end around the Journal Take-up Reel.

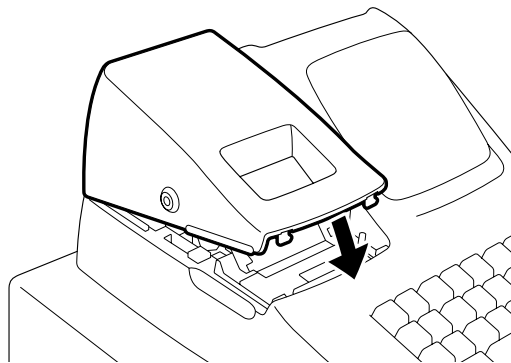

8

If the printer is used for journal, simply attach the Printer Cover. The Receipt Outlet is used as Journal Window.

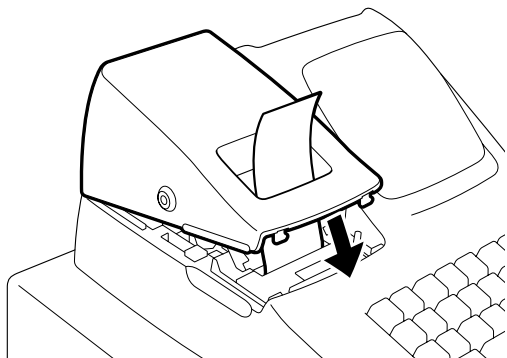

If the printer is used for receipts, attach the Printer Cover with the paper end coming out of the Receipt Outlet located on the Printer Cover.

9. Programming

The time and date should be adjusted and such data as status of each department, percent rate, etc. should be programmed before starting sale entries. Printing occurs as programming is proceeded.

- The programmed data will be retained by dry batteries even if the power of the machine is turned OFF or a power failure occurs.
- Set the Mode Select Switch to the **SET** position before starting any programming operation.
- Key indications in the operation patterns in this manual:

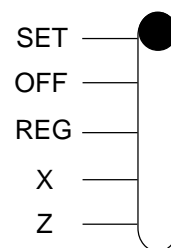

..... Entry through a Numeric Key

..... Function Key depression

System Option Setting

(Available after the Financial Reset (Z) Report is taken.)

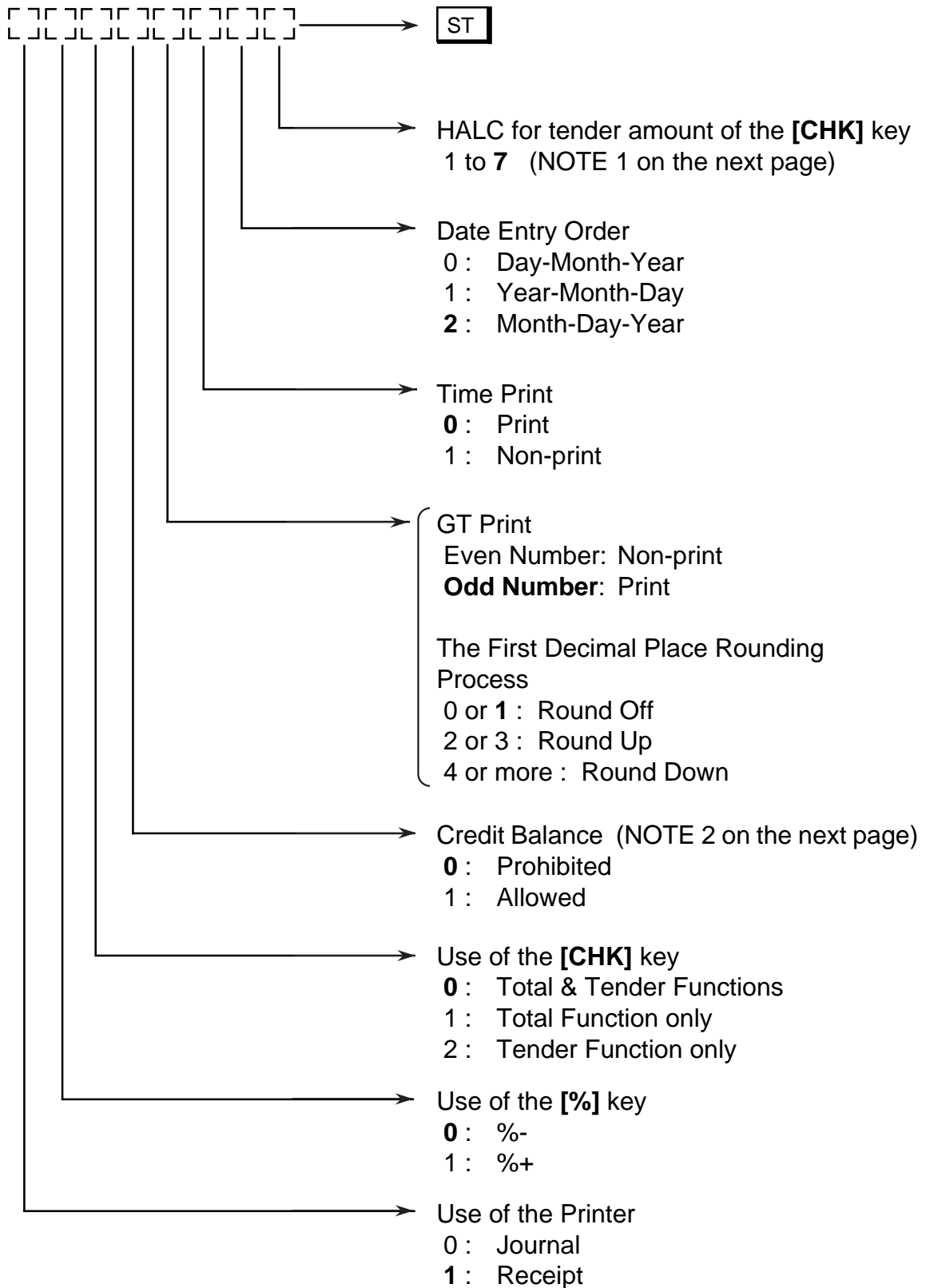

- NOTES:**
1. HALC (High Amount Listing Capacity) is used to check excessively high amounts entered by mistake. For example, if "3" is entered, it means 3 digits and the high amount limit is 999 (\$9.99).
 2. Credit Balance means that amount entries through the [] key will result in over-subtraction of the subtotal amount at the time of the entry through this key. If the status "Allowed" is selected, over-subtraction using the [] key will be allowed. The [VD] key is not subject to this "Credit Balance" status selection.
 3. Numeric values in bold face are those of the initial setting.

Sample Programming Operation

To set the following system options:

- The printer is used for receipts: 1
- The [%] key is used as the [% -] key: 0
- The [CHK] key is used for "Tender" function only: 2
- Credit Balance is allowed: 1
- GT Print (Print) & The First Decimal Place Rounding Process (Round Up): 3
- Time is printed: 0
- Date Entry Order (Month-Day-Year): 2
- Tender amount through the [CHK] key is allowed up to 5 digits (\$999.99): 5

Key Operation)

1 0 2 1 3 0 2 5 **ST**

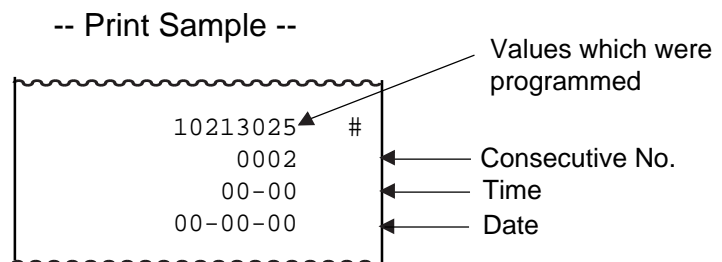

Department Status Setting

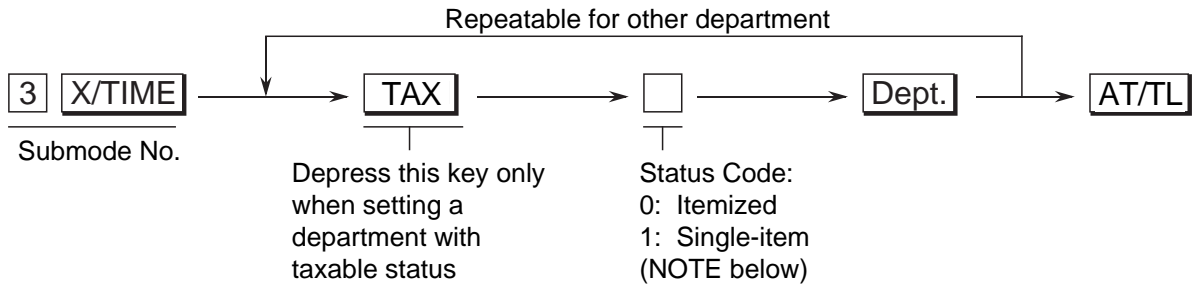

NOTES: 1. When a department is set to be an "Itemized" department, a sale item entry through that Department Key will not immediately finalize the sale and will allow other item entries until a media key ([AT/TL], [CHK] or [CH]) is operated.

When a department is set to be a "Single-item" department, a sale item entry through that Department Key will immediately finalize the sale as cash and issue a receipt if it is operated outside a sale. However, when a Single-item department is operated during a sale, it functions the same as an Itemized department.

2. Initial setting is as follows.

All departments Non-taxable & Itemized status

Sample Programming Operation

To set the following department status:

- Department 1 Taxable & Single-item
- Department 2 Non-taxable & Itemized
- Department 3 Taxable & Itemized
- Department 4 Non-taxable & Single-item

-- Print Sample --

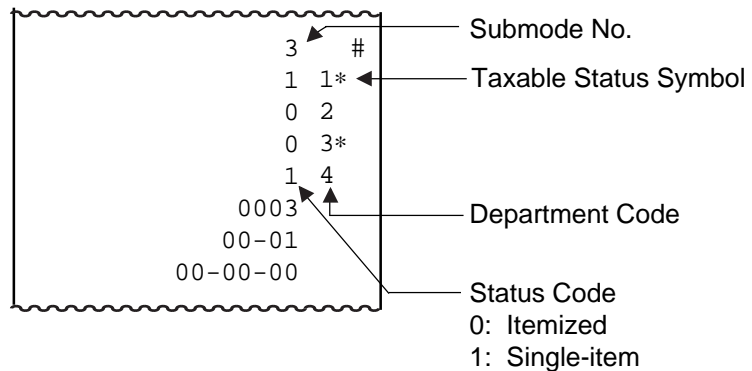

Key Operation)

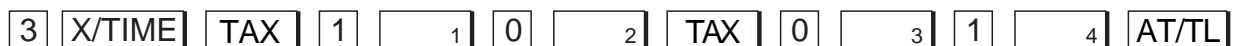

Time Setting

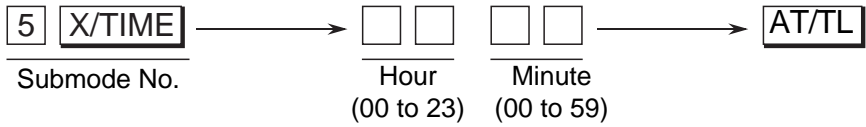

Sample Programming Operation

To set the time to 13:35 (1:35 p.m):

Key Operation)

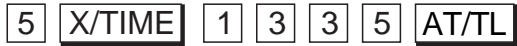

-- Print Sample --

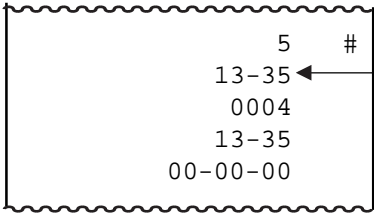

Time which was programmed

Date Setting

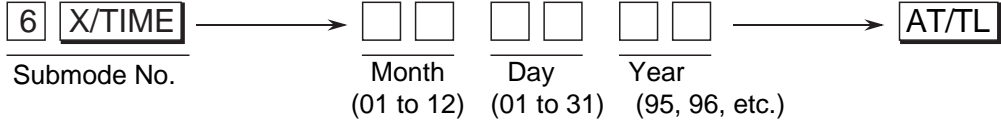

NOTE: The date entry order above shows the initial set order. The entry order of Day-Month-Year or Year-Month-Day can be selected instead of Month-Day-Year by the System Option Setting described in page 12.

Sample Programming Operation

To set the date to October 3, 1995:

Key Operation)



-- Print Sample --

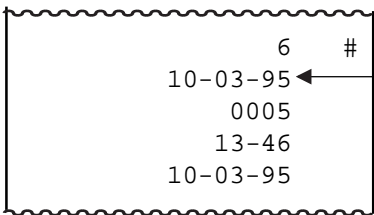

Date which was programmed

Department HALC Setting

The HALC (High Amount Listing Capacity) is used to check excessively high amounts entered by mistake. By setting HALCs, such mistakes will be prevented at the earliest stage.

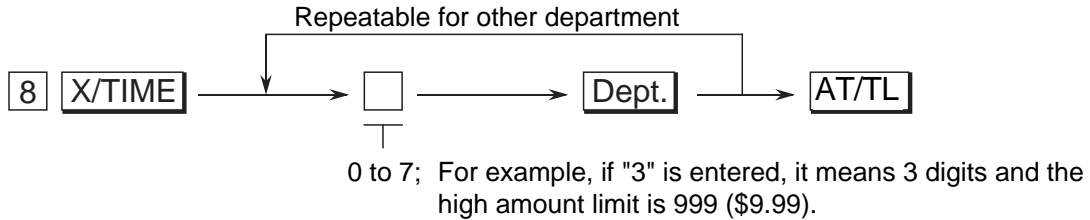

NOTE: Initial setting is as follows.
 All departments Price entry up to 7 digits (\$99999.99) is allowed.

Sample Programming Operation

To set the following department HALCs:

- Department 1 3 digits
- Department 2 4 digits
- Department 3 5 digits
- Department 4 6 digits

Key Operation)

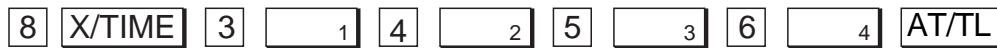

-- Print Sample --

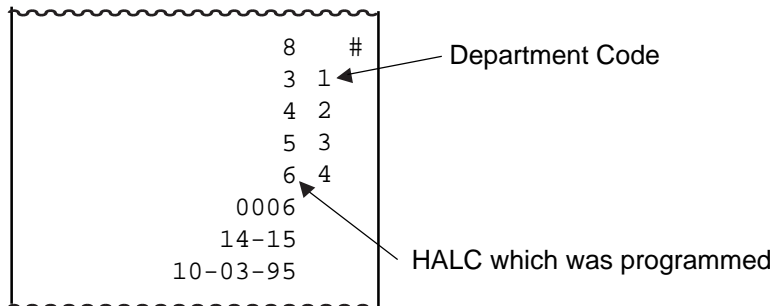

Secret Code Setting

When this code is set, operations in the "Z" mode will be prohibited without this code entry.

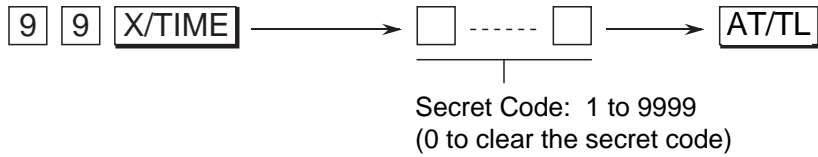

Sample Programming Operation

To set a secret code of 2428:

Key Operation)



-- Print Sample --

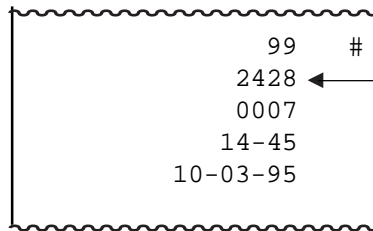

Secret Code which was programmed

% Rate Setting

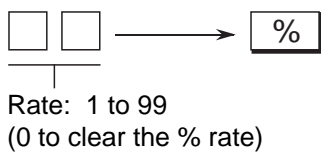

NOTE: Whether the % key is used as the function of %+ or %- is determined by the System Option Setting described in page 12.

Sample Programming Operation

To set 5% on the [%] key:

Key Operation)



-- Print Sample --

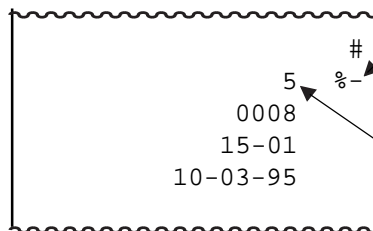

"%+" is printed if the [%] key is used as the [%+] key

% Rate which was programmed

PLU Setting

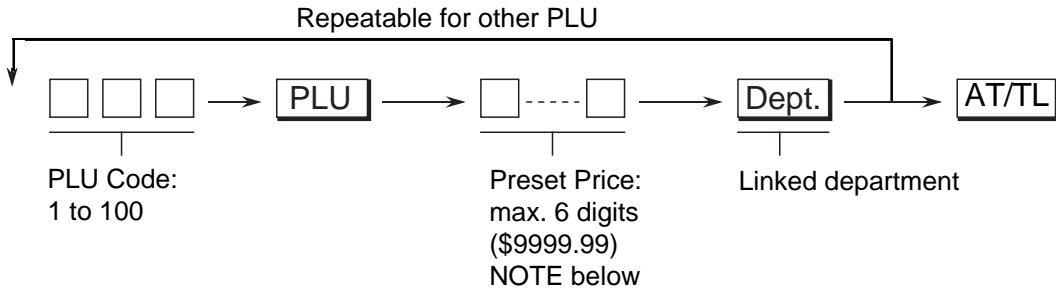

NOTE: When 0 is entered as a preset price in above key sequence, the preset price of \$0.00 will be programmed.

Sample Programming Operation

To set the following PLUs:

- PLU 6 (Preset Price: \$1.50, Linked Department: Department 1)
- PLU 24 (Preset Price: \$2.50, Linked Department: Department 2)
- PLU 28 (Preset Price: \$1.75, Linked Department: Department 3)
- PLU 30 (Preset Price: \$2.00, Linked Department: Department 4)

Key Operation)

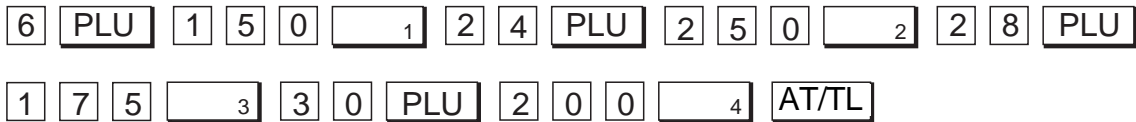

-- Print Sample --

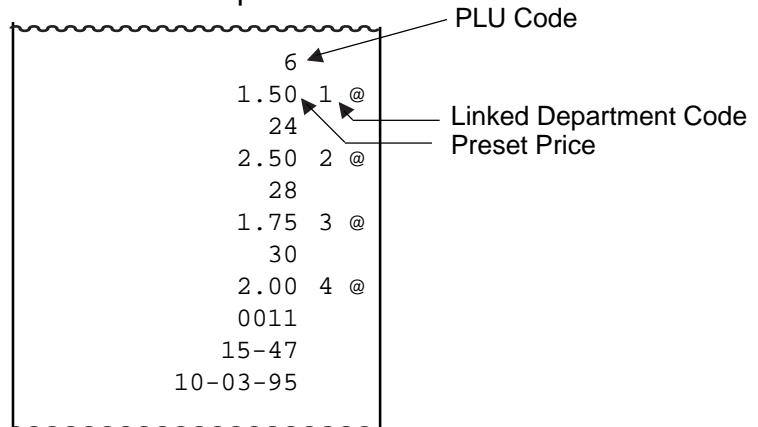

PLU Deletion

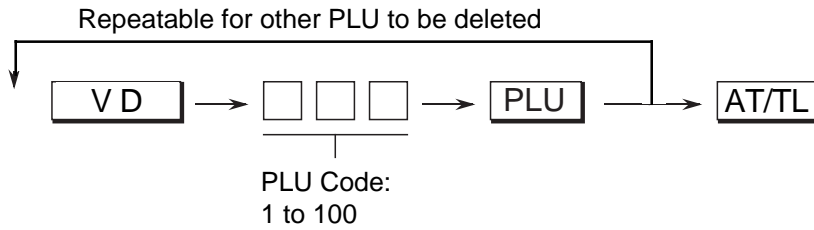

Sample Programming Operation

To delete the PLU Code 30 which was programmed in the preceding page:

Key Operation)



-- Print Sample --

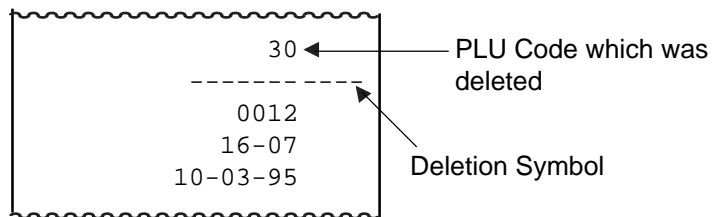

Amount Format Setting

This operation determines the Amount Format for display and print.

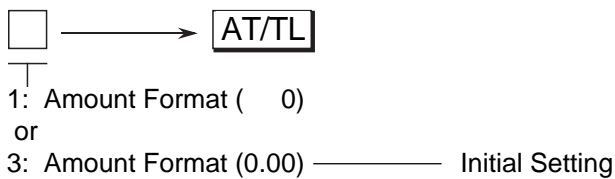

Sample Programming Operation

To set the Amount Format of " 0":

Key Operation)



-- Print Sample --

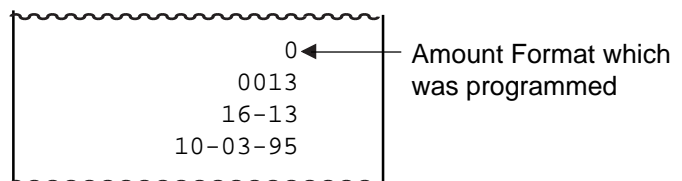

Tax Table Setting

TYPE 1: TAX FULL BREAKS (COMBINATION OF NON-CYCLIC AND CYCLIC BREAKS)

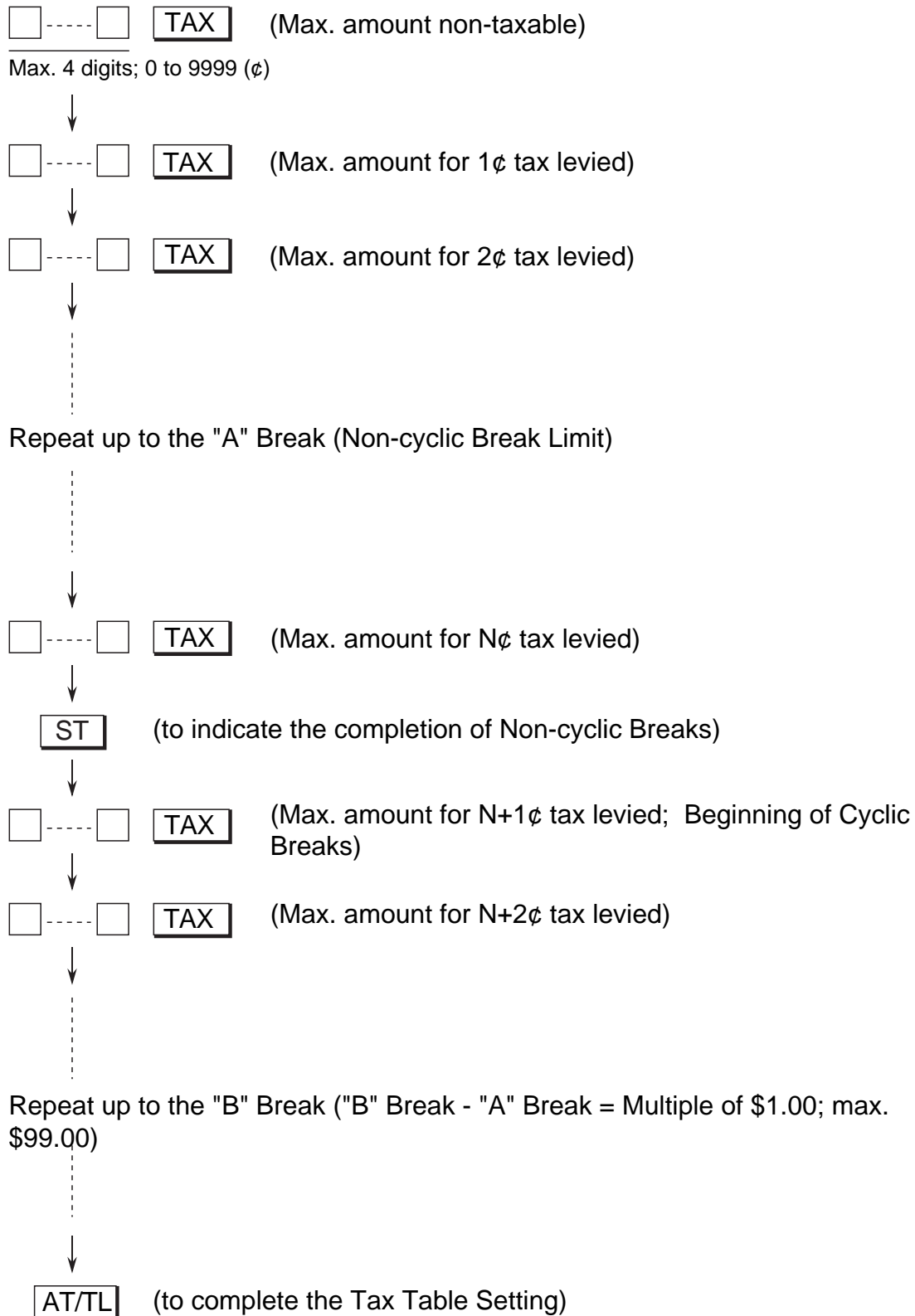

NOTE: A maximum of 32 breaks can be programmed for the tax table.

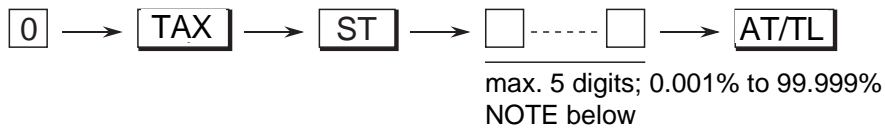
TYPE 2: TAX % ONLY

- NOTES:** 1. *As for a numeric value to be entered, be certain to include down to three decimal places. For example, to set 4%, enter "4000".*
2. *% Calculation Fraction Rounding Process for Tax is fixed to "Round Off".*

TYPE 3: COMBINATION OF NON-CYCLIC BREAKS AND % RATE

First, complete the setting of Non-cyclic Breaks as shown in TYPE 1.

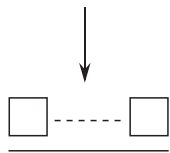

(Tax rate applied when exceeding the Non-cyclic Break amount)

The description for the Tax Rate in TYPE 2 is also applied to this case.

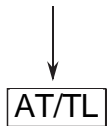

Sample Programming Operation

TYPE 1: TAX FULL BREAKS

To set the following Tax Break Table:

| Breaks | Tax | Amount Difference from Previous Break | |
|------------------|-----|---------------------------------------|----------------------------|
| \$0.01 to \$0.10 | 0¢ | | Non-cyclic Breaks |
| \$0.11 to \$0.21 | 1¢ | \$0.10 | |
| \$0.22 to \$0.35 | 2¢ | \$0.11 | |
| \$0.36 to \$0.50 | 3¢ | \$0.14 | One cycle of Cyclic Breaks |
| \$0.51 to \$0.64 | 4¢ | \$0.15 | |
| \$0.65 to \$0.78 | 5¢ | \$0.14 | |
| \$0.79 to \$0.92 | 6¢ | \$0.14 | |
| \$0.93 to \$1.07 | 7¢ | \$0.14 | |
| \$1.08 to \$1.21 | 8¢ | \$0.15 | |
| \$1.22 to \$1.35 | 9¢ | \$0.14 | |
| \$1.36 to \$1.50 | 10¢ | \$0.14 | |
| . | . | . | |
| . | . | . | |
| . | . | . | |

The same cycle repeats.

Key Operation)

-- Print Sample --

```

#
0.10 TX
0.21 TX
0.35 TX
0.35 ST
0.50 TX
0.64 TX
0.78 TX
0.92 TX
1.07 TX
1.21 TX
1.35 TX
1.35 TA
0014
16-29
10-03-95
    
```

TYPE 2: TAX % ONLY

To apply 15% to any amount:

Key Operation)

0 TAX ST 1 5 0 0 0 AT/TL

-- Print Sample --

```

#
0.00 TX
0.00 ST
15.000 %
0016
16-36
10-03-95
    
```

TYPE 3: COMBINATION OF NON-CYCLIC BREAKS AND % RATE

To set the following Tax Break Table:

| Breaks | Tax | Amount Difference from Previous Break |
|------------------|-----|---------------------------------------|
| \$0.01 to \$0.10 | 0¢ | |
| \$0.11 to \$0.22 | 1¢ | \$0.10 |
| \$0.23 to \$0.39 | 2¢ | \$0.12 |
| \$0.40 to \$0.56 | 3¢ | \$0.17 |
| \$0.57 to \$0.73 | 4¢ | \$0.17 |
| \$0.74 to \$0.90 | 5¢ | \$0.17 |
| \$0.91 to \$1.08 | 6¢ | \$0.17 |

Non-cyclic Breaks

⋮

% Rate of 6%

Key Operation)

1 0 TAX
 2 2 TAX
 3 9 TAX
 5 6 TAX
 7 3 TAX
 9 0 TAX
 1 0 8 TAX
 ST
 6 0 0 0 AT/TL

-- Print Sample --

```

#
0.10 TX
0.22 TX
0.39 TX
0.56 TX
0.73 TX
0.90 TX
1.08 TX
1.08 ST
6.000 %
0017
16-38
10-03-95
    
```

10. Verification of Programmed Data

The set data of the programming operations can be verified by the following operations. A receipt is issued for each operation.

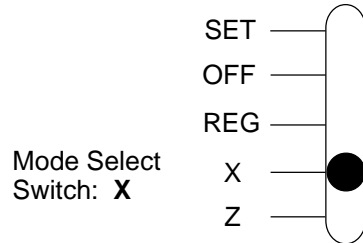

To read Department Status

2 ST

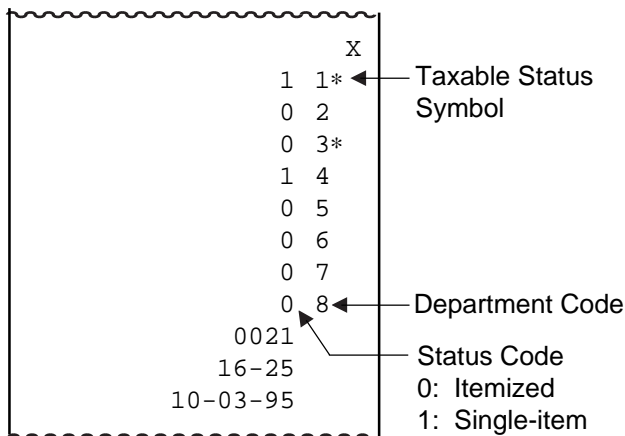

To read PLU Tables

3 ST

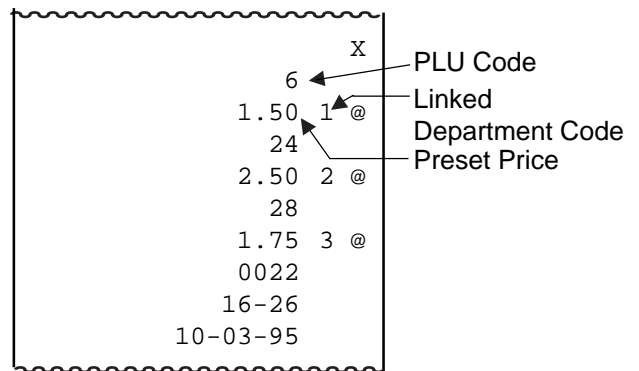

To read % Rate and the contents of the System Option

4 ST

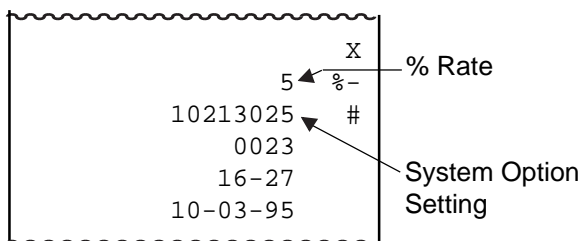



To calculate Tax Amount

..... TAX Displays the tax amount.
Any amount

NOTE: Result of the Tax Calculation Test is not printed.

11. Daily Operation Flow

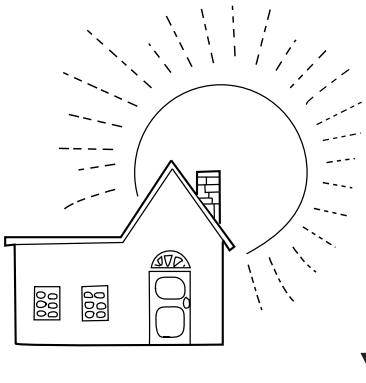
The following shows a typical daily operation flow on the register.

| Before Opening the Store... | | Reference <u>Page</u> |
|---|--|---|
|  | <ul style="list-style-type: none"> ● Ensure that the register is firmly plugged in the wall outlet. ● Check to see if sufficient portion of paper roll remains. ● Check the time, and print condition. | <p>3</p> <p>9</p> <p>26, 27</p> |
| During Business Hours... | | |
|  | <p style="text-align: center;"><i>Opening the store</i></p> <ul style="list-style-type: none"> ● Ordinary transaction entries ● Received-on-Account and Paid Out transactions ● Taking Read (X) Report. <p style="text-align: center;"><i>Closing the store</i></p> | <p>27</p> <p>35</p> <p>36</p> |
| After Closing the Store... | | |
|  | <ul style="list-style-type: none"> ● Taking Reset (Z) Report ● Tear off the print portion of Journal Paper (if the printer is used for journal recording). ● Leave the drawer open, and Set the Mode Select Switch to OFF. ● Take all the cash from the drawer to the office with the journal and Reset (Z) Report. | <p>36</p> <p>39</p> <p>40</p> <p>40</p> |

12. Transaction Entries

If the register is programmed with all requirements, it is ready to accept transaction entries. Before starting to enter transactions, set the Mode Select Switch to the **REG** position.

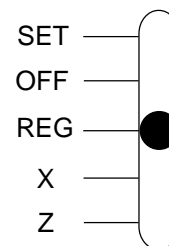

WARNING!

When opening the cash drawer, be careful not to let the drawer hit any person.

When an error has occurred...

When the buzzer sounds continuously and "E" is indicated in the leftmost digit of the display, the last operation has caused an error and the keyboard is locked. In that case:

Press the **[C]** key to cancel the error condition and the keyboard is now operable.

This function of the **[C]** key is also applied to operations in other Mode Select Switch positions.

If errors occur repeatedly on operating the same key sequence, check the cause of the error. The following are possible causes of error:

- The Mode Select Switch position is wrong.
- The numeric value entered exceeds the high amount limit.
- A numeric value has not been entered where required.
- A numeric value has been entered where prohibited.
- The key sequence is wrong, or a wrong key has been pressed.
- The operation is not allowed at the current timing.

Displaying the Time

The time can be displayed on the register any time when the register is outside a sale.

[X/TIME] Displays the current time.

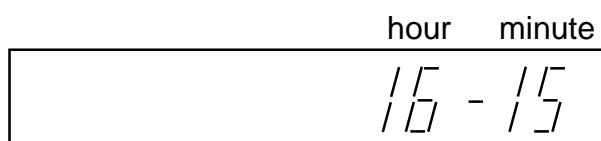

The time display will disappear when any key excluding the **[FEED]** key is pressed on the keyboard or the Mode Select Switch position is changed.

No-sale

The No-sale transaction is used to open the drawer without relating to a sale, for such purposes of money exchanges, checking the print condition on the paper roll, etc.



Sale Item Entries (Department Entries)

1) Entry of One Item

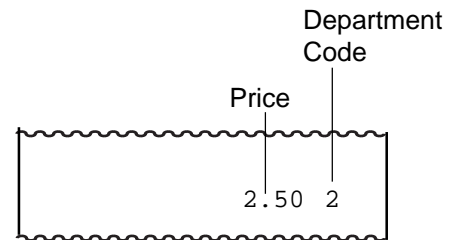
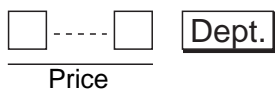

NOTE: The Price entry is possible up to 7 digits. However, it is limited by the Department HALC (High Amount Listing Capacity).

2) Repeat Entry

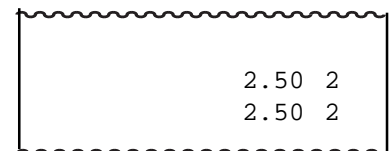

NOTE: Depress again the Department key that has been depressed for one item entry. The item entry will be repeated as many times as the key is depressed.

3) Quantity Extension (Multiplication)

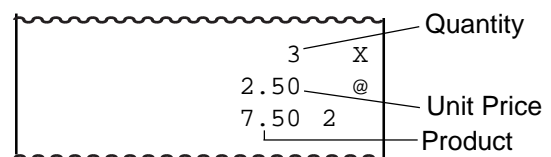
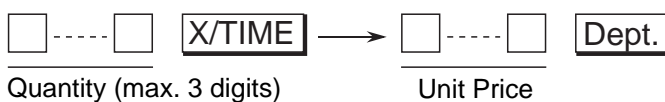

NOTE: The product (obtained by multiplication) must not exceed 7 digits.

4) Single-item Department

If a Department Key is programmed with Single-item status, any entry through the key will immediately finalize the sale as cash without operating any media key.

The operation is the same as ordinary itemized Department keys already described (**Entry of One Item, Quantity Extension**), except that Repeat Entry is not possible using a Single-item Department key.

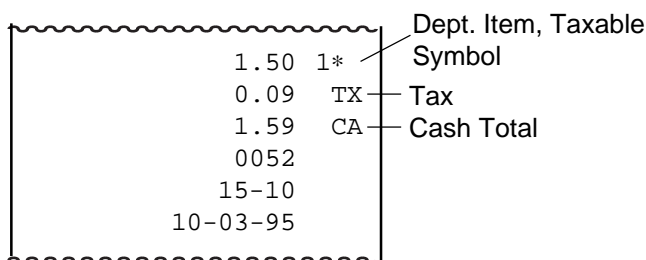

5) Tax Modification (applicable to Add-on Tax Feature)

Each department is programmed with its own Tax status (Non-taxable, or Taxable). To reverse the Tax status (from taxable to non-taxable, or vice versa), depress the following key before or during the required department item entry (before the Department Key, at the latest). (Refer to **Entry of One Item, Repeat Entry, Quantity Extension**.)

TAX ... to reverse Tax status

- NOTES:**
1. The tax-modified status declared by the Tax Modifier key will be held until another item is entered. The modified status is held even when the item is repeated.
 2. When a Department item is tax-modified and repeated and the same item (with the same price and department) must still be entered consecutively within a sale with the original tax status regained, depress the **[C]** key before entering original tax-status item.

Sale Item Entries (PLU Entries)

1) Entry of One Item

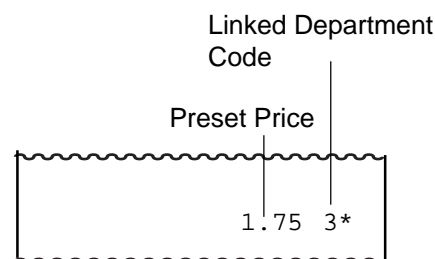
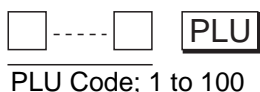

2) Repeat Entry

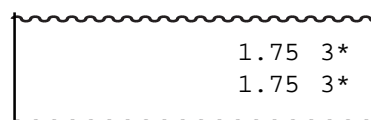

NOTE: Depress again the PLU key that has been depressed for one item entry. The item entry will be repeated as many times as the key is depressed.

3) Quantity Extension (Multiplication)

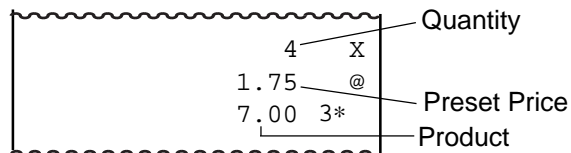
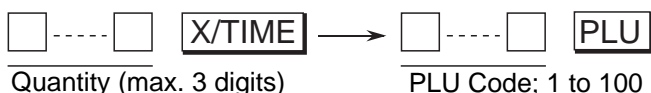

NOTE: The product (obtained by multiplication) must not exceed 7 digits.

4) Single-item PLU

If a PLU is linked to a Department with Single-item status, the entry of this PLU will immediately finalize the sale as cash without operating any media key.

The operation is the same as ordinary itemized PLU already described (**Entry of One Item, Quantity Extension**), except that Repeat Entry is not possible using a Single-item PLU.

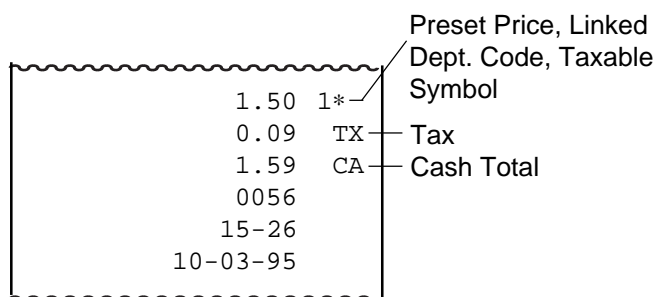

5) Tax Modification (applicable to Add-on Tax Feature)

Tax status (Non-taxable, or Taxable) for each PLU is determined by that of the linked Department. To reverse the Tax status (from taxable to non-taxable, or vice versa), depress the following key before or during the required PLU item entry (before the PLU Entry, at the latest). (Refer to **Entry of One Item, Repeat Entry, Quantity Extension**.)

TAX ... to reverse Tax status

- NOTES:**
1. The tax-modified status declared by the Tax Modifier key will be held until another item is entered. The modified status is held even when the item is repeated.
 2. When a PLU item is tax-modified and repeated and the same item must still be entered consecutively within a sale with the original tax status regained, depress the **[C]** key before entering original tax-status item.

Dollar Discount

1) Dollar Discount on a Department Item or a PLU Item

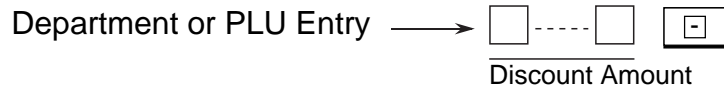

2) Dollar Discount on Subtotal

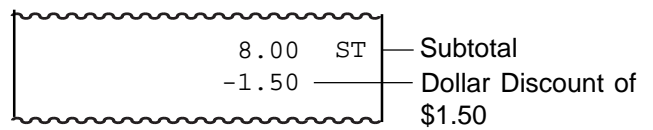

NOTE: The discount amount must not exceed the item amount or the subtotal unless the "Credit Balance" option is selected.

Percent Discount or Percent Charge

The [%] key can be programmed to function Percent Discount or Percent Charge.

1) Percent Discount/Charge on a Department Item or a PLU Item

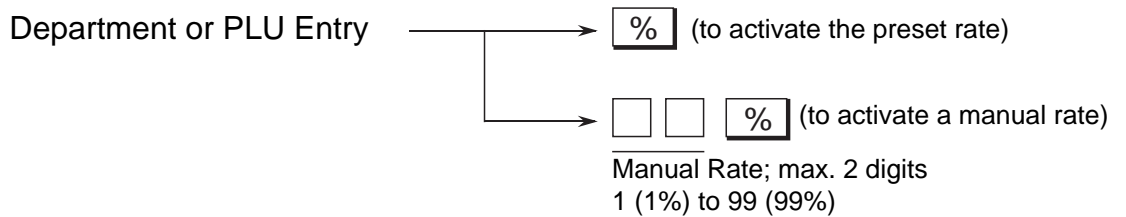

2) Percent Discount/Charge on Subtotal

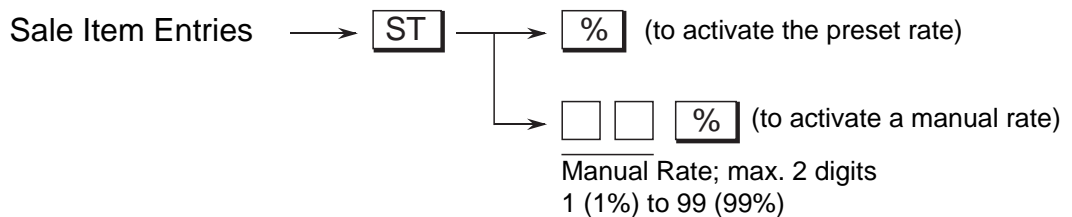

NOTE: When a Manual Rate is entered, the preset rate is disregarded.

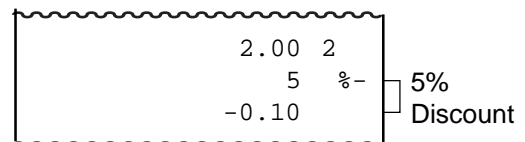

Void

Sale items once entered within the current sale can be voided.

1) Last Line Voiding

When the last line item (that has just been entered within the current transaction) is a Department item, a PLU item, Dollar Discount item, or Percent Discount/Charge item, it can be voided by simply pressing the **[VD]** key.

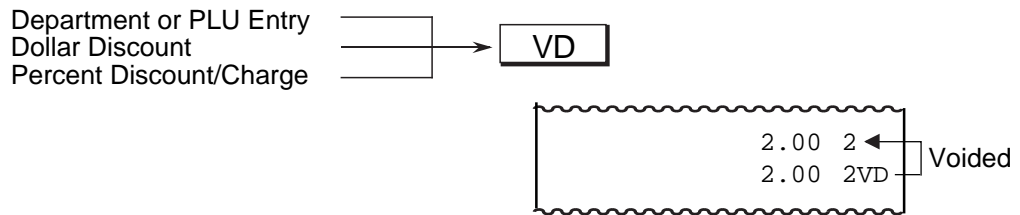

2) Designated Line Voiding

When a Department or a PLU item entered before the last item is canceled before the sale is finalized, it can be voided. To operate it, follow the ordinary Department or PLU entry procedure (**Entry of One Item, Quantity Extension**) except that the **[VD]** key is depressed just before the Department or PLU key depression.

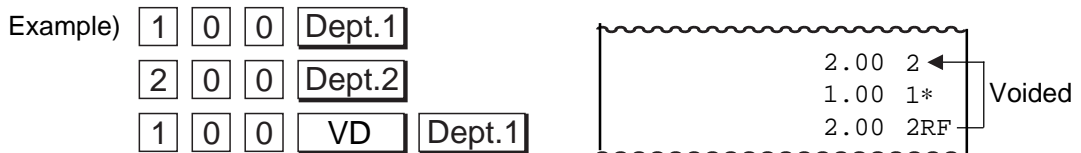

Returned Merchandise

The Returned Merchandise transaction is used to refund money to a customer who has returned items already purchased. This operation must be performed outside a sale only.

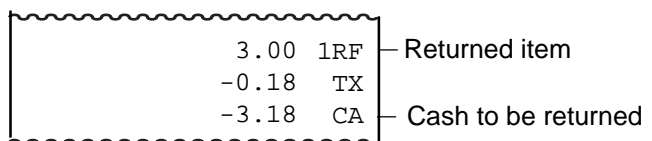
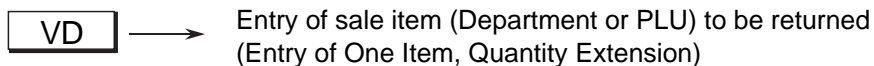

Non-add Number Print

This function is to print any code number for future reference, such as Customer No., Credit Card No., House Charge Account No., etc. Non-add numbers can be entered at the starting of a sale or during a sale if the sale is not finalized. Multiple non-add numbers can be entered in a sale.



Subtotal Read and Print

To read the total of the current sale by the customer's request or the operator's requirement, simply depress the **[ST]** key.

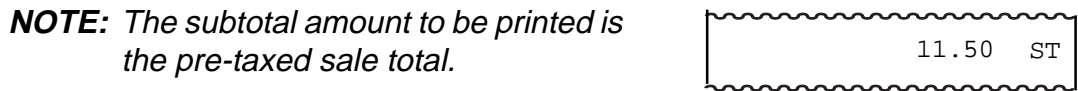
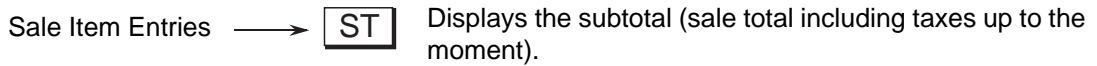

Finalizing a Sale

1) Cash Total

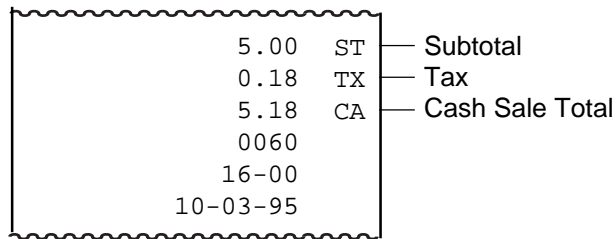

2) Cash Tender

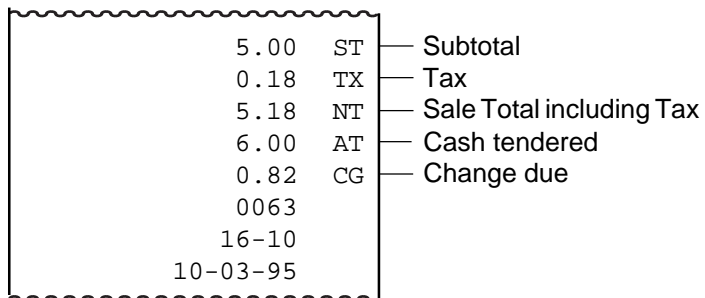

NOTE: The sale is finalized as in the sample receipt above when the tendered amount is equal to or larger than the sale total (including taxes). When the tendered amount is smaller than the sale total (short-tendered), the balance due is displayed and the sale is not finalized. In such cases, refer to "6) Multi-tender" and "7) Split Tender" on the page 34.

3) Charge or Credit Total

Sale Item Entries → (**ST**) → **CH**

| | | |
|----------|----|------------------|
| 5.00 | ST | Subtotal |
| 0.18 | TX | Tax |
| 5.18 | CH | Charge or Credit |
| 0064 | | Sale Total |
| 16-11 | | |
| 10-03-95 | | |

4) Check Total

Sale Item Entries → (**ST**) → **CHK**

| | | |
|----------|----|------------------|
| 5.00 | ST | Subtotal |
| 0.18 | TX | Tax |
| 5.18 | CK | Check Sale Total |
| 0067 | | |
| 16-15 | | |
| 10-03-95 | | |

5) Check Tender

Sale Item Entries → (**ST**) → ----- **CHK**
 Check Tendered Amount

| | | |
|----------|----|--------------------------|
| 5.00 | ST | Subtotal |
| 0.18 | TX | Tax |
| 5.18 | NT | Sale Total including tax |
| 10.00 | CK | Check tendered |
| 4.82 | CG | Change due |
| 0068 | | |
| 16-20 | | |
| 10-03-95 | | |

NOTE: The System Option Setting allows you to select the following functions of the **[CHK]** key.

- Total & Tender functions
- Total function only
- Tender function only

6) Multi-tender

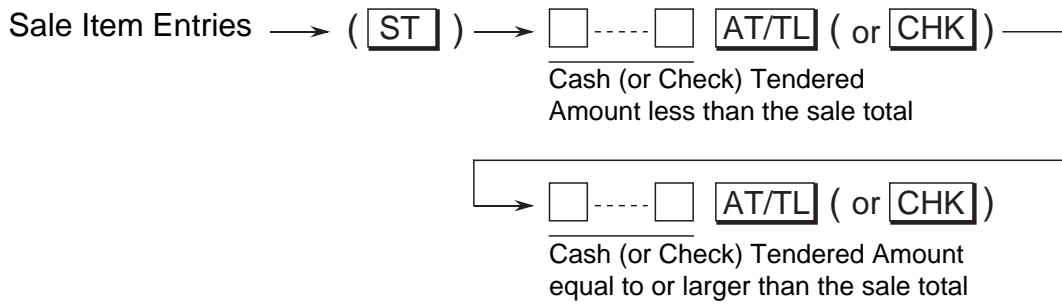

| | | |
|----------|----|--------------------------------|
| 5.00 | ST | Subtotal |
| 0.18 | TX | Tax |
| 5.18 | TA | Sale Total including tax |
| 3.00 | AT | Cash tendered (short-tendered) |
| 5.00 | AT | Cash tendered (over-tendered) |
| 2.82 | CG | Change due |
| 0069 | | |
| 16-23 | | |
| 10-03-95 | | |

7) Split Tender

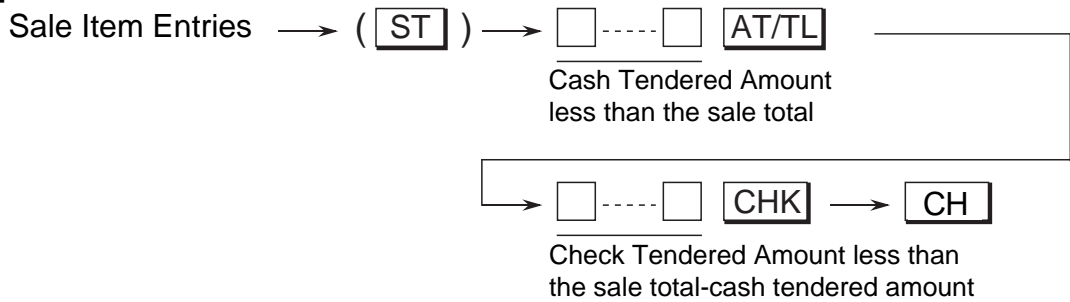

| | | |
|----------|----|---------------------------------|
| 15.00 | ST | Subtotal |
| 0.90 | TX | Tax |
| 15.90 | TA | Sale Total including tax |
| 3.00 | AT | Cash tendered (short-tendered) |
| 5.00 | CK | Check tendered (short-tendered) |
| 7.90 | CH | Charge or Credit Total |
| 0070 | | |
| 16-25 | | |
| 10-03-95 | | |

- NOTES:**
1. A maximum of 7 digits can be entered as Tendered Amount (up to \$99999.99).
 2. When the sale total is zero or negative, the sale can only be finalized by Cash Total function.

Tax Exemption

The Tax Exemption transaction is used to exempt all taxes from the sale total.

Sale Item Entries → (**ST**) → **TAX** → Finalizing a sale

| | | |
|------|----|---------------------------------------|
| 5.00 | 3* | Sale item Entries with Taxable Status |
| 1.75 | 3* | |
| 6.75 | ST | Cash Sale Total without Tax |
| 6.75 | CA | |

The following operations require the **X** position of the Mode Select Switch.

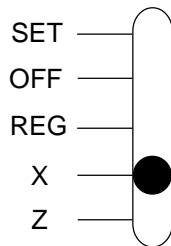

Received-on-Account Payment

(Mode Select Switch: **X**)

The Received-on-Account transaction is used to identify money which is in the drawer but not due to business. For example, a customer pays for a sale finalized as house charge on a past day, or the operator records the change reserve in the drawer loaded from the store office. This operation must be performed outside a sale only.

----- **#/RA** The drawer opens to enable money entry into the drawer.

Payment Amount Received;
max. 7 digits (up to \$99999.99)

| | |
|-------|----|
| 10.00 | RA |
|-------|----|

Paid Out

(Mode Select Switch: **X**)

The Paid Out transaction is used when an amount of money is removed from the drawer without relating to a sale, for the purpose of paying to a wholesaler, etc. This operation must be performed outside a sale only.

----- **NS/PO** The drawer opens to enable paying out.

Amount to be paid out;
max. 7 digits (up to \$99999.99)

| | |
|-------|----|
| 12.00 | PO |
|-------|----|

13. Read (X) and Reset (Z) Reports

This Chapter describes the operation to take Read and Reset reports and their print formats.

Before Taking Reports...

- The Read (X) Report allows to read the totals but not clear the memory, while the Reset (Z) Report allows to read the totals and, at the same time, clear all the resettable totals when the report has been issued.
- The symbol "X" is printed at the top right of a Read Report, while "Z" is printed on a Reset Report to indicate the type of report. The contents of the two types of reports are the same if both are taken at the same time.

WARNING!

When opening the cash drawer, be careful not to let the drawer hit any person.

OPERATION

Read (X) Report

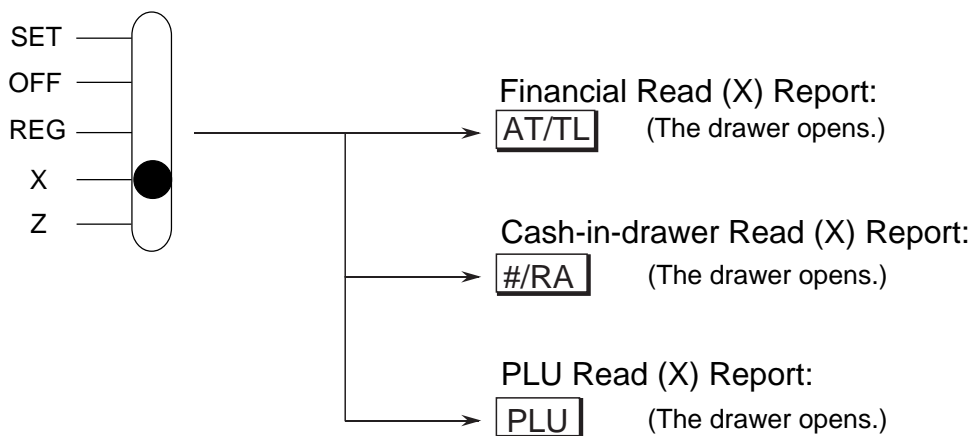

Reset (Z) Report

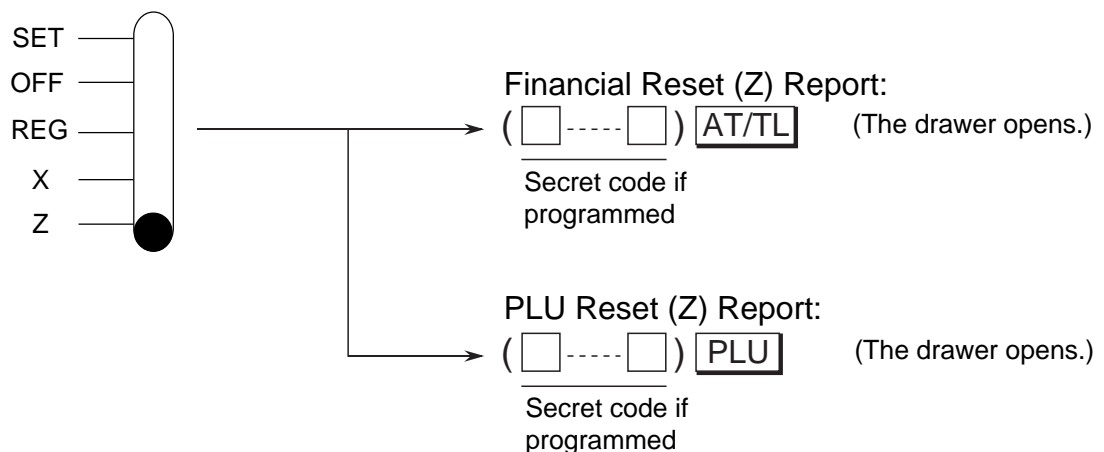

| |
|-----------------------|
| Memory Balance |
|-----------------------|

Grand Total = (Sum of Gross Sale)

Gross Sale = (Depts. Total) + (Tax Amount) + (Returned Merchandise & Designated Line Voiding) + $\frac{\text{Last Line Voiding}}{\text{NOTE 1}}$ + $\frac{(\%+)}{\text{NOTE 2}}$

Net Sale with Tax = (Depts. Total) + (Tax Amount) + $\frac{(\%+)}{\text{NOTE 2}}$

Media Total = (Cash Sales) + (Check Sales) + (Charge Sales)
 = (Net Sale with Tax) - $\frac{(\%-)}{\text{NOTE 3}}$ - (Dollar Discount)

Customer Total = (Cash Sales Customer) + (Check Sales Customer) + (Charge Sales Customer)

Returned Merchandise & Designated Line Voiding
 = (Returned Merchandise & Designated Line Voiding) + $\frac{\text{Negative Tax Amount}}{\text{NOTE 4}}$

- NOTES:**
1. *The void transaction of %- and Dollar Discount is not processed to the Void Memory. However, the void transaction of %+ is processed to its memory.*
 2. *In case that the [%] key is used as the [%+] key.*
 3. *In case that the [%] key is used as the [%-] key.*
 4. *"Negative Tax Amount" means a tax amount to be returned to a customer with an amount of a returned item.*

Report Sample Format

Financial Report

| | | |
|----------|-----|--|
| | Z | Reset Report Symbol ("X" for Read Report) |
| 257.06 | # | Grand Total (non-resettable) |
| 28 | | Gross Sale: Item Count |
| 83.06 | * | Amount |
| 4 | 1 | Dept. 1 Sale: Item Count |
| 8.20 | | Amount |
| 7 | 2 | |
| 29.00 | | |
| 2 | 3 | |
| 3.50 | | |
| 2 | 4 | |
| 3.20 | | |
| 2 | 5 | |
| 5.50 | | |
| 5 | 6 | |
| 16.30 | | |
| 2 | 7 | |
| 4.80 | | |
| 1 | 8 | Dept. 8 Sales: Item Count |
| 1.00 | | Amount |
| 1.96 | TX | Tax Total |
| 25 | | Net Sale with Tax: Item Count |
| 73.46 | NS | Amount |
| 1 | | %- Count |
| 0.90 | %- | Amount |
| 4 | | Dollar Discount |
| 6.50 | - | Amount |
| 16 | | Total Customer Count |
| 66.06 | NT | Media Total |
| 12 | | Cash Sales: Customer Count |
| 34.75 | CA | Amount |
| 1 | | Check Sales: Customer Count |
| 5.41 | CK | Amount |
| 3 | | Charge or Credit Sales: Customer Count |
| 25.90 | CH | Amount |
| 3 | | Received-on-account Count |
| 32.60 | RA | Amount |
| 1 | | Paid Out Count |
| 10.00 | PO | Amount |
| 52.76 | *TA | Cash-in-drawer Amount |
| 10.00 | *CK | Check-in-drawer Amount |
| 1 | | Last Line Voiding Count |
| 3.60 | VD | Amount |
| 2 | | Returned Merchandise & Designated |
| 6.00 | RF | Line Voiding: Item Count, Amount |
| 0003 | Z | Reset Counter |
| 0096 | | Consecutive No. |
| 19-20 | | Time |
| 10-03-95 | | Date |

Cash-in-drawer Report

| | | |
|----------|-----|-----------------------|
| | X | |
| 52.76 | *TA | Cash-in-drawer Amount |
| 0090 | | |
| 19-05 | | |
| 10-03-95 | | |

PLU Report

| | | |
|----------|---|--------------------------|
| | Z | |
| 6 | | PLU Code 6 Sales: Count |
| 3 | | Amount |
| 4.50 | | |
| 24 | | |
| 4 | | |
| 10.00 | | |
| 28 | | |
| 7 | | |
| 12.25 | | |
| 30 | | PLU Code 30 Sales: Count |
| 1 | | Amount |
| 2.00 | | |
| 0002 | Z | Reset Counter |
| 0092 | | |
| 19-10 | | |
| 10-03-95 | | |

14. Maintenance

WARNING!

Care must be taken not to injure yourself with the paper cutter.

Replacing the Paper Roll

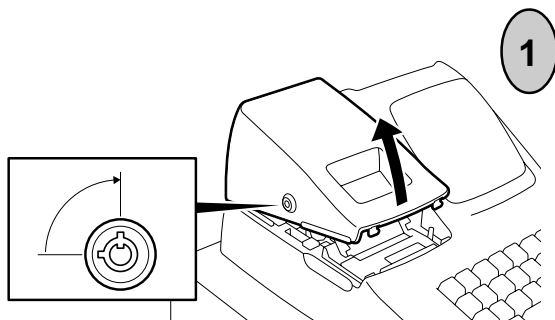

1

To remove the Printer Cover, insert the Printer Cover/Drawer key to the Printer Cover Lock, and then turn it 90° clockwise.

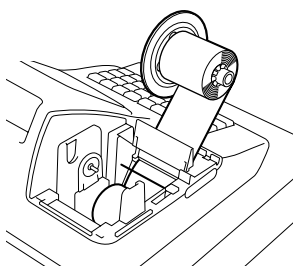

2

If the printer is used for Journal, hold down the **[FEED]** key to wind up the printed portion of paper, then cut the paper as shown in the figure. Hold down the **[FEED]** key again to advance the remaining paper end.

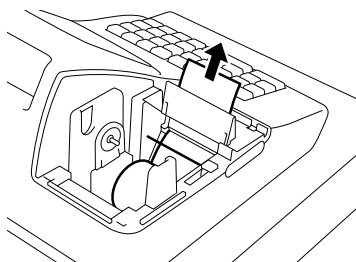

If the printer is used for Receipt, cut the paper roll as shown in the figure. Then hold down the **[FEED]** key to advance the remaining paper end.

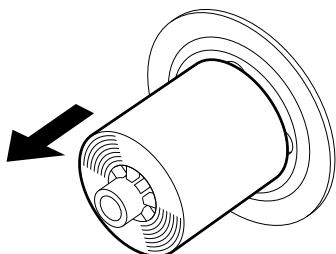

The wound-up portion of the paper (when used for Journal) can easily be removed from the Reel by pulling it sideways.

3

Set the paper roll ready for print. Refer to Chapter "8. Installing the Paper Roll".

Replacing the Ink Roller

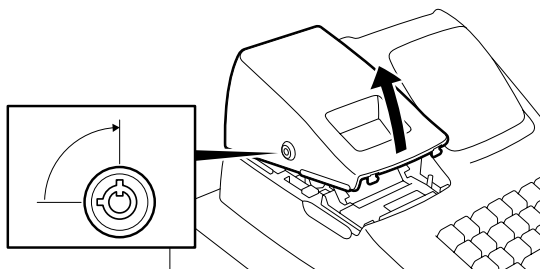

1

To remove the Printer Cover, insert the Printer Cover/Drawer key to the Printer Cover Lock, and then turn it 90° clockwise.

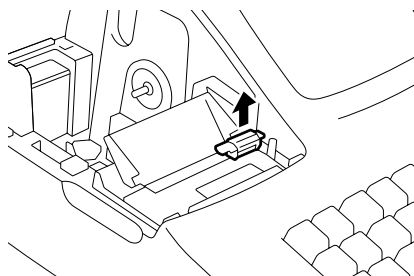

2

Pinch the Ink Roller Knob with your fingers, and pull it upward.

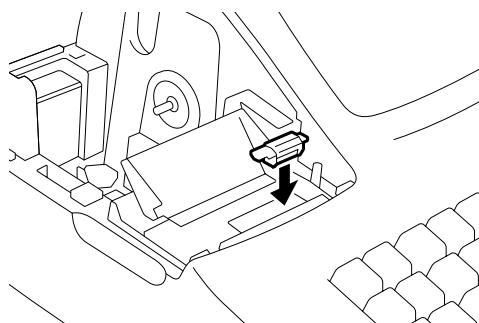

3

Insert the new Ink Roller in the slot of the carriage by pushing it all the way in until it is firmly settled with a "click" sound.

Manual Drawer Release

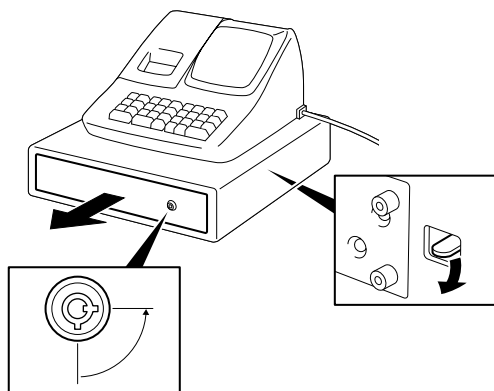

The drawer will automatically open on appropriate operations. However, in the event of a power failure, etc., the drawer can be released manually.

First, insert the Printer Cover/Drawer Key to the Drawer Key Lock, then turn it 90° counter-clockwise.

Next, push the Drawer Release Lever located on the bottom side of the register in the direction of the arrow, and the drawer opens.

Removing the Drawer

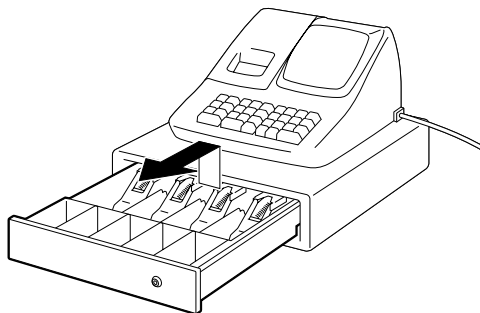

Pull out the drawer all the way until it hits the stopper. Then lift up the drawer and pull it again.

WARNING!

When opening the cash drawer, be careful not to let the drawer hit any person.

Battery Exchange

WARNING: *Be certain to replace batteries with new ones every year. If they run down, the programmed data and sales data will all be cleared.*

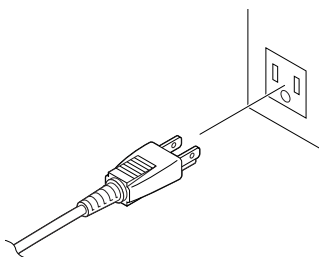

1

To exchange batteries, please keep the power cord of the register connected to the wall outlet. If the batteries are removed with the power cord disconnected, the programmed data and sales data will all be cleared.

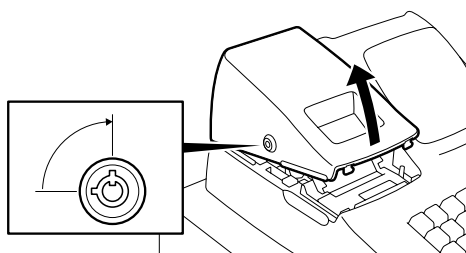

2

To remove the Printer Cover, insert the Printer Cover/Drawer key to the Printer Cover Lock, and then turn it 90° clockwise.

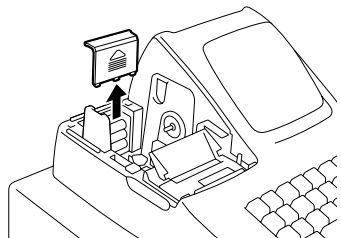

3

Remove the Battery Cover.

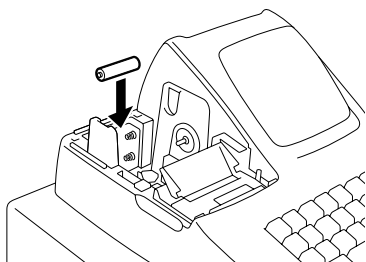

4

Replace the old batteries with new ones, while confirming that the positive (+) and negative (-) ends face the proper directions. (Batteries: SUM-3 1.5V x 3 pieces)

NOTE: Do not mix used and new batteries in the battery compartment.

5

Return the item removed in Step 3, and attach the Printer Cover.

15. Specifications

Size 350 mm (width) x 400 mm (depth) x 250.8 mm
(height including rubber feet)

Weight 4.76 kg

Power Required 117V \pm 10%, 60Hz

Power Consumed 0.08A

Operating Temperature 0°C to 40°C

Operating Humidity 10% to 90% RH

Size of Paper Roll 57.5 \pm 0.5mm (width) x max. 80mm (diameter),
0.06 to 0.085mm (thickness)

Memory Protection Dry Battery SUM-3 1.5 V x 3 pieces;
Life of about 1 year
(Be certain to replace batteries with new ones every year.)

Handling the Batteries

- When inserting batteries, place them so that the positive (+) and negative (-) ends face the proper directions as shown in the battery compartment.
- Do not mix used and new batteries in the battery compartment. Replace all batteries at the same time.
- Do not leave discharged batteries in the battery compartment. Leakage from such batteries may damage the register.
- Do not dispose the batteries in a fire. If put in a fire, they may explode.

Specifications are subject to change without notice.



TEC

Toshiba TEC Corporation