

TEC

TEC Electronic Cash Register

FS-1450-1 SERIES

Owner's Manual

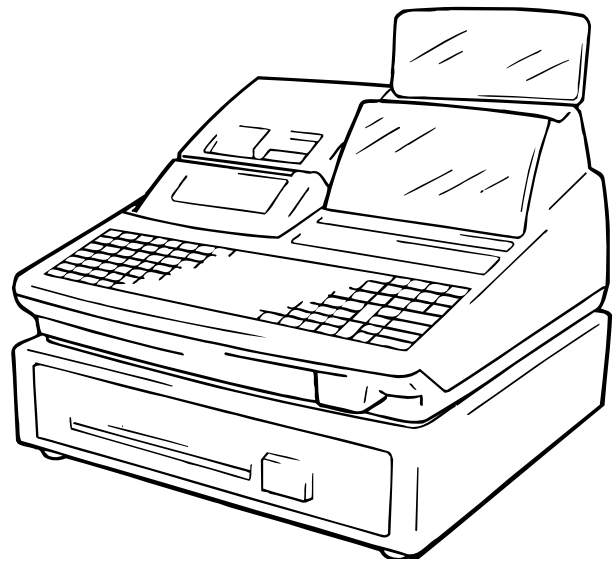

TOSHIBA TEC CORPORATION

NOTICE

This equipment has been tested and found to comply with the limits for a Class A digital device, pursuant to Part 15 of the FCC Rules. These limits are designed to provide reasonable protection against harmful interference when the equipment is operated in a commercial environment. This equipment generates, uses, and can radiate radio frequency energy and, if not installed and used in accordance with the instruction manual, may cause harmful interference to radio communications. Operation of this equipment in a residential area is likely to cause harmful interference in which case the user will be required to correct the interference at his own expense. Changes or modifications not expressly approved by manufacturer for compliance could void the user's authority to operate the equipment.

WARNING

"This Class A digital apparatus meets all requirements of the Canadian Interference-Causing Equipment Regulations."

"Cet appareil numérique de la classe A respecte toutes les exigences du Règlement sur le matériel brouilleur du Canada."

Safety Summary

Personal safety in handling or maintaining the equipment is extremely important. Warnings and Cautions necessary for safe handling are included in this manual. All warnings and cautions contained in this manual should be read and understood before handling or maintaining the equipment.

Do not attempt to effect repairs or modifications to this equipment. If a fault occurs that cannot be rectified using the procedures described in this manual, turn off the power, unplug the machine, then contact your authorized TOSHIBA TEC representative for assistance.

Meanings of Each Symbol



This symbol indicates warning items (including cautions). Specific warning contents are drawn inside the \triangle symbol. (The symbol on the left indicates a general caution.)



This symbol indicates prohibited actions (prohibited items). Specific prohibited contents are drawn inside or near the \circ symbol. (The symbol on the left indicates "no disassembling".)













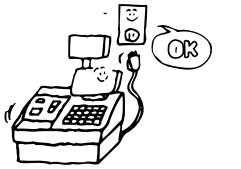

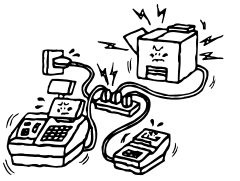







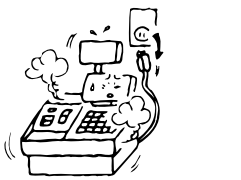

This symbol indicates actions which must be performed. Specific instructions are drawn inside or near the \bullet symbol. (The symbol on the left indicates "disconnect the power cord plug from the outlet".)

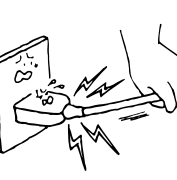

WARNING

This indicates that there is the risk of **death** or **serious injury** if the machines are improperly handled contrary to this indication.

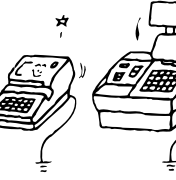
<p> Prohibited</p> <p>■ Do not plug in or unplug the power cord plug with wet hands as this may cause electric shock.</p> 	<p> Any other than the specified AC voltage is prohibited.</p> <p>■ Do not use voltages other than the voltage (AC) specified on the rating plate, as this may cause fire or electric shock.</p> 
<p> Prohibited</p> <p>■ If the machines share the same outlet with any other electrical appliances which consume large amounts of power, the voltage will fluctuate widely each time these appliances operate. Be sure to provide an exclusive outlet for the machine as this may cause the machines to malfunction.</p> 	<p> Prohibited</p> <p>■ Do not place metal objects or water-filled containers such as flower vases, flower pots or mugs, etc. on top of the machines. If metal objects or spilled liquid enter the machines, this may cause fire or electric shock.</p> 
<p> Prohibited</p> <p>■ Do not insert or drop metal, flammable or other foreign objects into the machines through the ventilation slits, as this may cause fire or electric shock.</p> 	<p> Prohibited</p> <p>■ Do not scratch, damage or modify the power cords. Also, do not place heavy objects on, pull on, or excessively bend the cords, as this may cause fire or electric shock.</p> 
<p> Disconnect the plug.</p> <p>■ If the machines are dropped or their cabinets damaged, first turn off the power switches and disconnect the power cord plugs from the outlet, and then contact your authorized TOSHIBA TEC representative for assistance. Continued use of the machine in that condition may cause fire or electric shock.</p> 	<p> Disconnect the plug.</p> <p>■ Continued use of the machines in an abnormal condition such as when the machines are producing smoke or strange smells may cause fire or electric shock. In these cases, immediately turn off the power switches and disconnect the power cord plugs from the outlet. Then, contact your authorized TOSHIBA TEC representative for assistance.</p> 

 <p>Disconnect the plug.</p> 	<p>■ If foreign objects (metal fragments, water, liquids) enter the machines, first turn off the power switches and disconnect the power cord plugs from the outlet, and then contact your authorized TOSHIBA TEC representative for assistance. Continued use of the machine in that condition may cause fire or electric shock.</p>	 <p>Disconnect the plug.</p> 	<p>■ When unplugging the power cords, be sure to hold and pull on the plug portion. Pulling on the cord portion may cut or expose the internal wires and cause fire or electric shock.</p>
 <p>Connect a grounding wire.</p> 	<p>■ Ensure that the equipment is properly grounded. Extension cables should also be grounded. Fire or electric shock can occur on improperly grounded equipment.</p>	 <p>No disassembling.</p> 	<p>■ Do not remove covers, repair or modify the machine by yourself. You may be injured by high voltage, very hot parts or sharp edges inside the machine. Unauthorized modification is prohibited.</p>

 **CAUTION** This indicates that there is the risk of personal **Injury** or **damage** to objects if the machines are improperly handled contrary to this indication.

Precaution

The following precautions will help to ensure that this machine will continue to function correctly.

- Try to avoid locations that have the following adverse conditions:
 - * Temperatures out of the specification
 - * Direct sunlight
 - * High humidity
 - * Shared power socket
 - * Excessive vibration
 - * Dust/Gas
- Do not subject the machine to sudden shocks.
- Do not press the keys too hard. Keys will operate correctly if they are touched lightly.
- Clean the cover and keyboard, etc. by wiping with a dry cloth or a cloth soaked with detergent and wrung out thoroughly. Never use thinner or other volatile solvent for cleaning.
- At the end of the day, turn the power OFF, then clean and inspect the exterior of the machine.
- Try to avoid using this equipment on the same power supply as high voltage equipment or equipment likely to cause mains interference.
- USE ONLY TOSHIBA TEC SPECIFIED consumables.
- DO NOT STORE the consumables where they might be exposed to direct sunlight, high temperatures, high humidity, dust, or gas.
- When moving the machine, take hold of the drawer and lift the machine.
- Do not place heavy objects on top of the machines, as these items may become unbalanced and fall causing **injury**.
- Do not block the ventilation slits of the machines, as this will cause heat to build up inside the machines and may cause **fire**.
- Do not lean against the machine. It may fall on you and could cause **injury**.

Request Regarding Maintenance

- Utilize our maintenance services.
After purchasing the machines, contact your authorized TOSHIBA TEC representative for assistance once per year or so to have the inside of the machines cleaned. Otherwise, dust will build up inside the machines and may cause **fire** or **malfunction**. Cleaning is particularly effective before humid rainy seasons.
- Our maintenance service performs the periodic checks and other work required to maintain the quality and performance of the machines, preventing accidents beforehand.
For details, please consult your authorized TOSHIBA TEC representative for assistance.
- Using insecticides and other chemicals
Do not expose the machines to insecticides or other volatile solvents, as this will deteriorate the cabinet or other parts or cause the paint to peel.

OPERATOR'S GUIDE

TABLE OF CONTENTS

	Page
1. TO OUR CUSTOMERS	1
2. UNPACKING	2
3. APPEARANCE AND NOMENCLATURE	3
4. MODE LOCK AND MODE SELECTOR KEYS	4
5. DISPLAY	5
6. OUTLINE OF PREPARATION PROCEDURE BEFORE OPERATING THE ECR	7
7. CASHIER SIGNING OR CASHIER KEY OPERATIONS	12
8. KEYBOARD LAYOUT	19
9. FUNCTIONS OF EACH KEY	20
10. REGISTERING PROCEDURE AND PRINT FORMAT	26
11. JOURNAL AND RECEIPT PAPER-END DETECTOR	59
12. ECR PRINTER MOTOR LOCK DETECTOR	59
13. GUEST CHECK PRINTER MOTOR LOCK DETECTOR	59
14. PRINTER GUIDE OPEN DETECTOR	59
15. PAPER ROLL REPLACEMENT AND OTHER MAINTENANCE OPERATIONS	60
16. SPECIFICATIONS	66

1. TO OUR CUSTOMERS

Thank you for choosing the TEC electronic cash register FS-1450 series. This instruction manual provides a description of the functions and handling of this register and should be read carefully to ensure optimum performance. Since every consideration has been given to safety and reliability, there is no danger of damaging the machine by incorrect operation.

Please refer to this manual whenever you have any questions concerning the machine. This machine has been manufactured under strict quality control and should give you full satisfaction. However, if the machine is damaged during transit, or there are any unclear points in this manual, please contact your local TOSHIBA TEC representative.

- The specifications described in this manual may be modified by TOSHIBA TEC, if necessary.
- Be sure to keep this manual for future reference.

2. UNPACKING

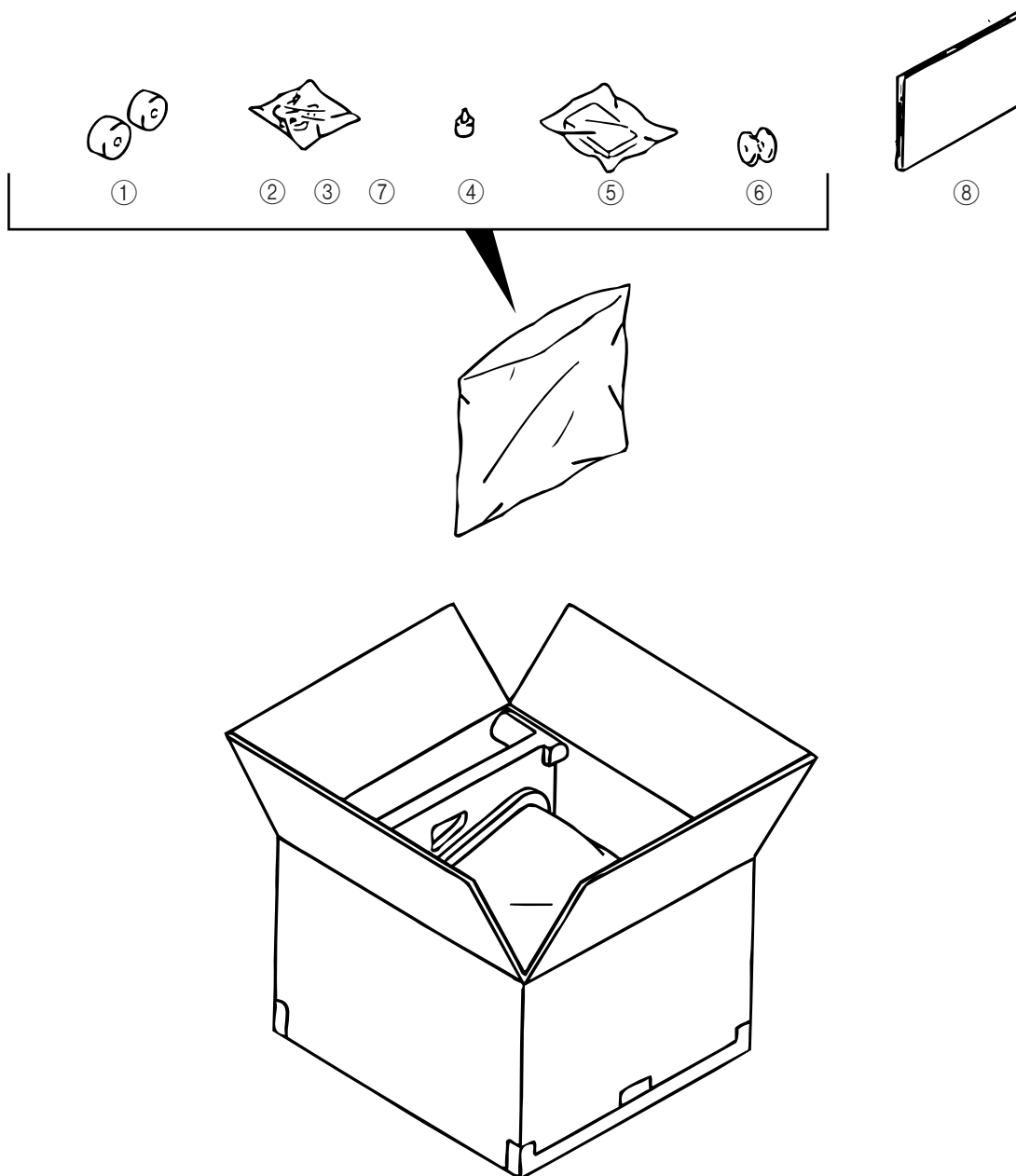

- ① Paper Roll 45 mm x Ø50 mm (2 pcs.)
- ② Mode Key
(**REG** Key, **MGR** Key, **MA** Key,
S Key; 2 pcs. respectively)
- ③ Receipt Cover Key (2 pcs.)
- ④ Stamp Ink (1 pc.)

- ⑤ Ribbon Cassette (1 pc.)
- ⑥ Journal Reel (1 pc.)
- ⑦ Drawer Key (2 pcs.)
- ⑧ Owner's Manual (1 pc.)

3. APPEARANCE AND NOMENCLATURE

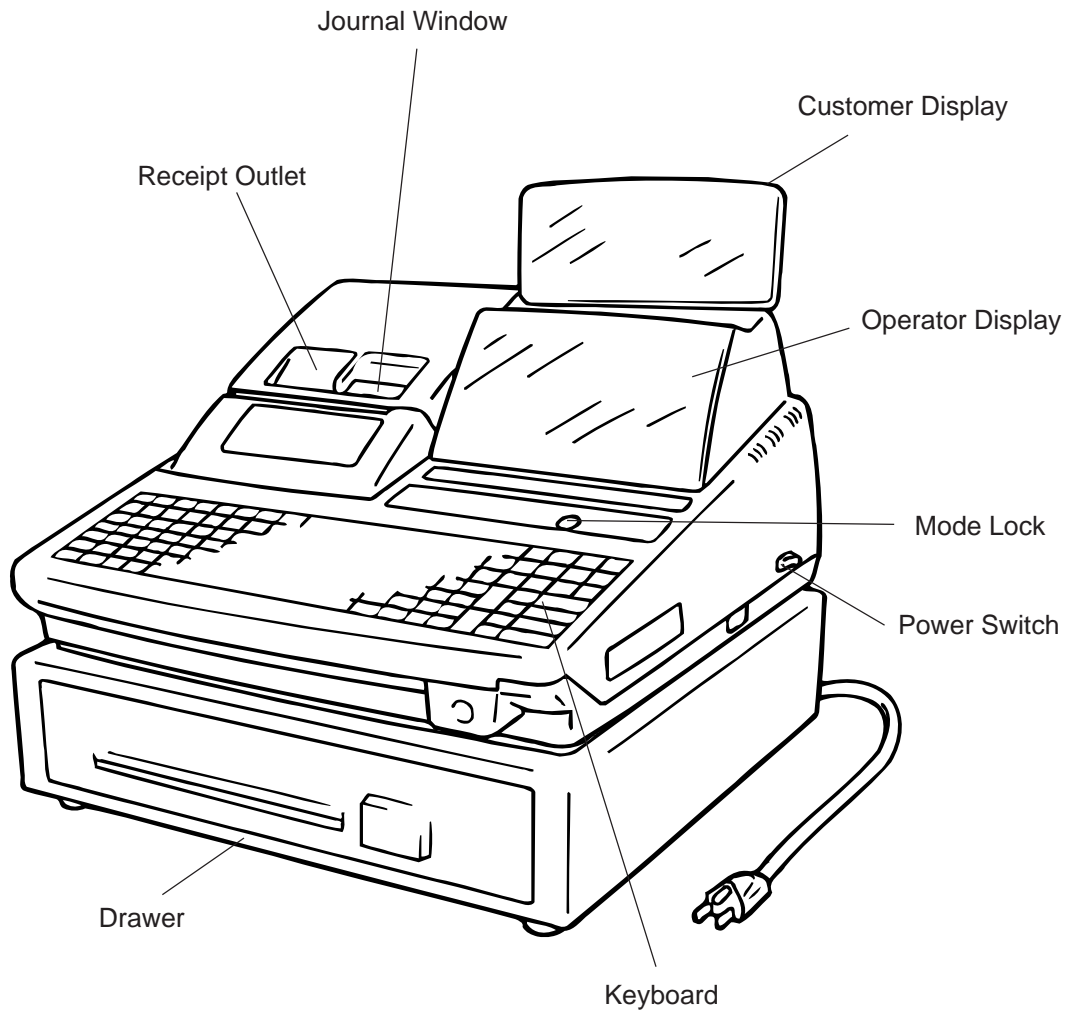

- **Power Switch** The power switch is provided at the right-hand side of the cabinet. The AC power is turned on when the switch is pushed to ON, and turned off when the switch is pushed to OFF.

4. MODE LOCK AND MODE SELECTOR KEYS

4.1. MODE LOCK

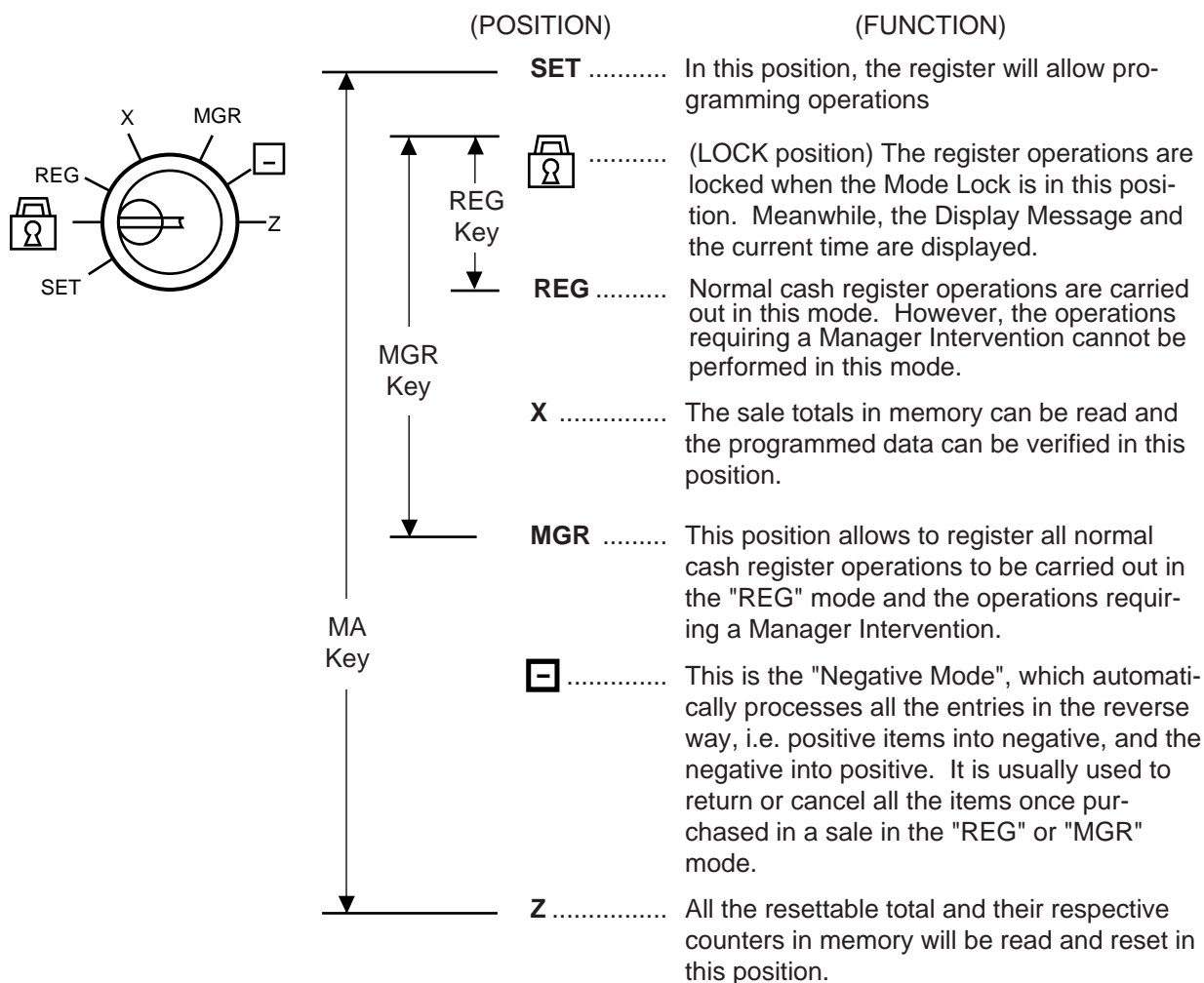

4.2. MODE SELECTOR KEYS



REG Key: The REG Key is used by the cashier or clerk who operates the register.

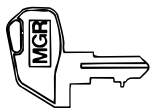

MGR Key: The MGR Key is used by the store manager or a person authorized by the manager.

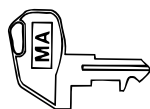

MA Key: The MA Key is used by the store manager who will daily supervise the collection of money and the printout of transactions recorded by the register. This key is also used when programming the register.

The keys may be inserted or pulled out at the "LOCK" or "REG" position.

In the OPERATOR'S GUIDE, functions and operations will be described within the range of the Mode Lock positions of LOCK and REG using the REG key. Since operations requiring other positions and keys are controlled by the store manager, they are described in the MANAGER'S GUIDE.

5. DISPLAY

The operator display is located at the top of the register just above the keyboard.

OPERATOR DISPLAY (Front Display)

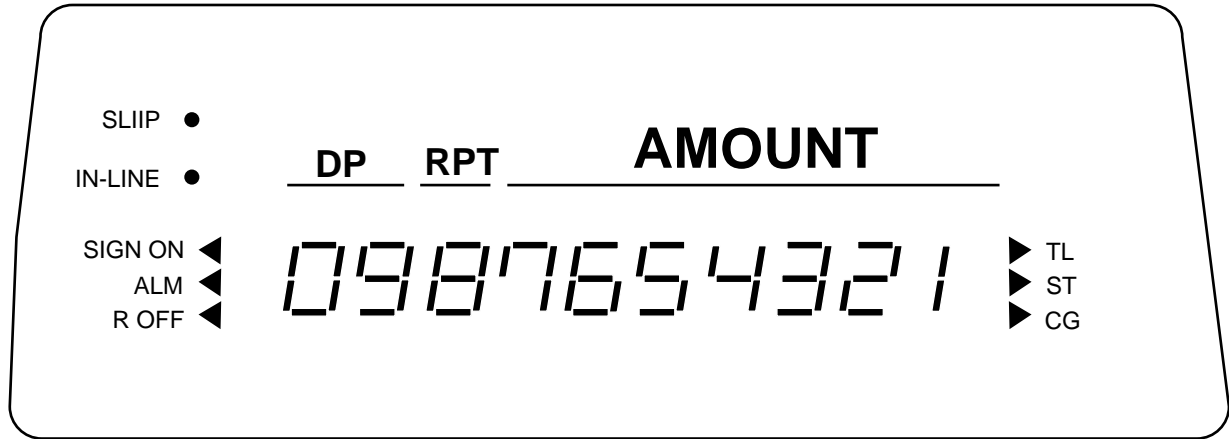

The customer display can be fixed as a rear display or moved to form a remote display. It can be moved up, down, to the right, and to the left, and thus is fully adjustable according to the position of the customer.

CUSTOMER DISPLAY (Rear or Remote Display)

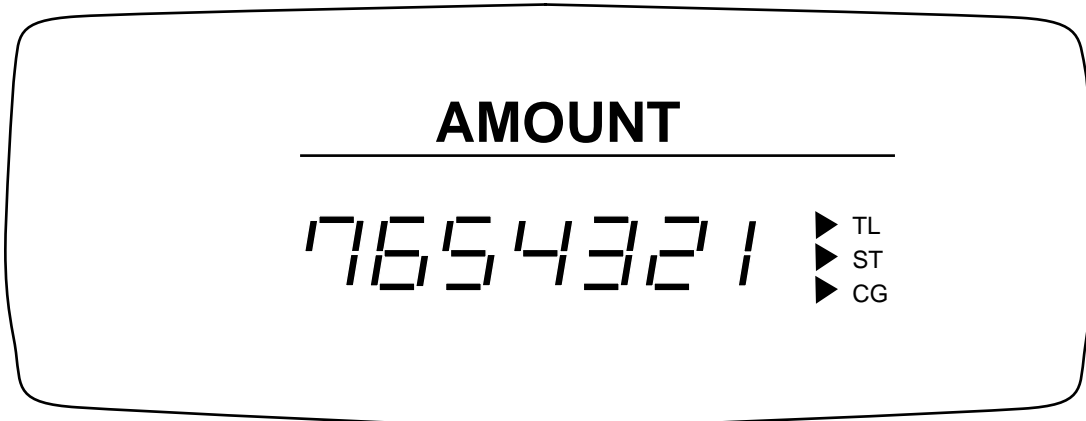

5.1. NUMERIC DISPLAY

- AMOUNT (7 digits): Displays the numeric data, such as amount, quantity, etc. When the amount is negative, the symbol "-" is displayed as well.
- NOTE:** *When the following code is being entered, the digits for "RPT" and "DPT" may be used as well (all 10 digits). On exceeding the 10 digits, the lowest 10 digits are being displayed.
Non-add Number (max. 18 digits)*
- DPT (2 digits): Displays the Department Code of the department item just entered. It stays lit when repeating the same department item entry. Program option allows an ECR to display a cashier No. instead of a department code. In this case, department code is not displayed even when department item is entered.
- RPT (1 digit): Displays the repeat count of the same Department or PLU item. The count is indicated from the second entry on, and only the lowest digit of the repeat count will be displayed even when the count exceeds nine (such as "0" for 10, "1" for 11, etc.)

5.2. TRIANGULAR LAMPS

- SIGN ON ◀ This lamp turns lit only when the Cashier Code Entry method is selected. It lights up when a cashier has signed ON or signed IN. It goes out when the cashier has signed OFF or signed OUT.
- ALM ◀ Lights up with the alarm buzzer generated to indicate that the last operation or numeric entry was an error. To clear the error status, depress the **[C]** key.
- R OFF ◀ Lights up when the Receipt-OFF mode is declared by the **[LOG/RECEIPT]** (or **[RECEIPT]**) key. In this condition, no receipts will be issued for a sale to be entered. It goes out by depressing the **[LOG/RECEIPT]** (or **[RECEIPT]**) key again for Receipt-ON mode.
- ▶ TL Lights up on a finalizing operation with the total amount displayed when the sale is finalized without any amount tendered.
- ▶ ST Lights up when the **[ST]** key is depressed, indicating that the displayed amount is subtotal. The lamp is also illuminated when the **[TXBL TL]** or **[FSTL/TEND]** key is depressed, indicating that the displayed amount is the taxable total or food-stampable total. It also lights up when the amount tendered is less than the sale total with the shortage amount (balance due) is displayed.
- ▶ CG When an amount tendering operation is performed, it lights up with the change due displayed.

5.3. STATUS LAMPS

- SLIP ● Lights up when a validation slip is properly inserted to allow validation print. It flickers to require a validation when the validation compulsory status has been programmed on the last operation. It also flickers to require an endorsement print using the Guest Check Printer or the Receipt/Journal Printer.
- IN-LINE ● Flickers when a PC job is being executed.

6. OUTLINE OF PREPARATION PROCEDURE BEFORE OPERATING THE ECR

This chapter shows the outline of set-up procedure of the ECR before actually starting the ECR operation.

WARNING!

Turn the **POWER SWITCH** to **OFF** before connecting the power cord.

1

Remove the cash register from the carton, referring to Chapter "2. Unpacking". And take out all the parts and accessories.

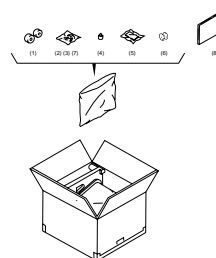

2

Remove the tapes and seals for holding parts or protecting the register surfaces.

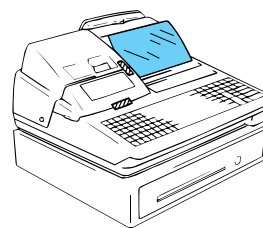

3

Plug the power cord of the register into a wall outlet. Make sure that the outlet voltage matches that of the power required for the register.

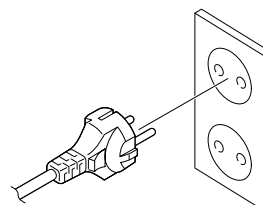

4

Insert the **REG** key into the Mode Lock.

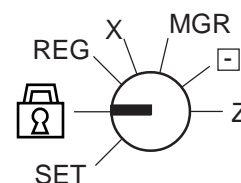

5

Turn the Mode Lock to the **REG** position with the power ON.

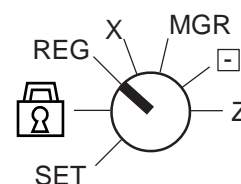

6

Install the Receipt and Journal rolls (referring to the following section "*Installing the Receipt/Journal Roll*").

Installing the Receipt/Journal Roll

WARNING!

Care must be taken not to injure yourself with the paper cutter.

Installing the Receipt Roll

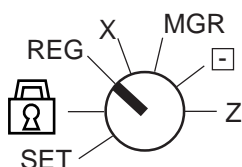

1

Turn the Mode Lock to the **REG** position with power ON.

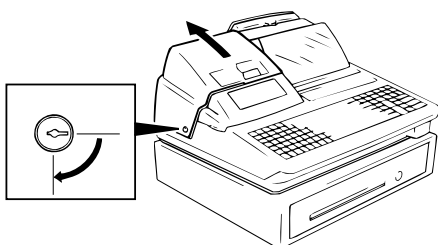

2

To remove the Receipt Cover, insert the Receipt Cover Key to the Receipt Cover Lock, and then turn it 90° clockwise.

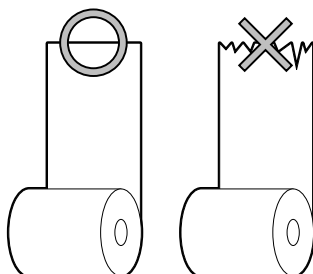

3

Cut the paper end to make it sharp.

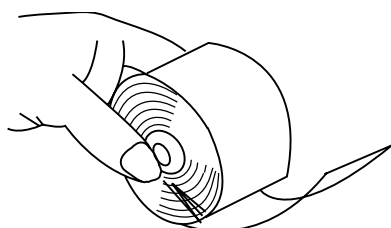

4

Hold the paper roll so that the paper end will be fed from the bottom.

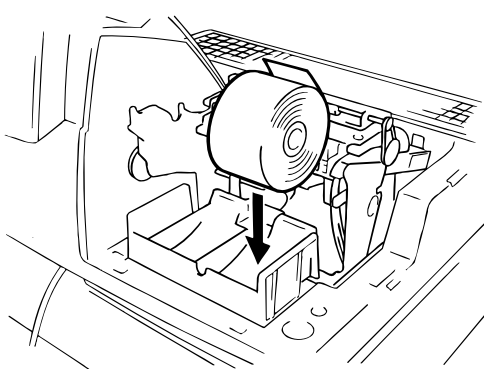

- 5 Place the paper roll in the outer side holder of the two roll holders.

6

There are the following two ways of receipt paper feed procedure.

A: Manual installation

B: Installation using the **[RF]** key

A: Manual installation

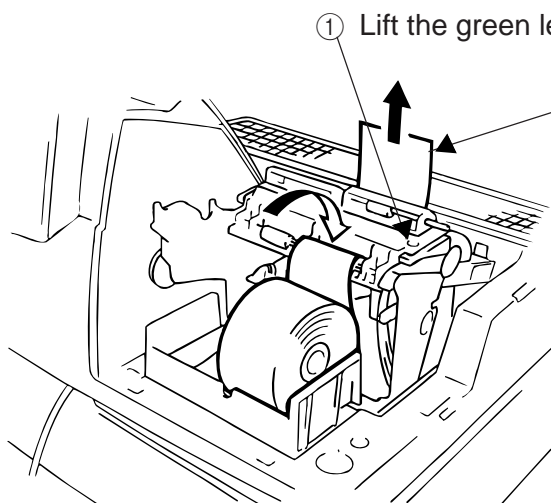

- 1 Lift the green lever on the receipt side.

- 2 Insert paper from the rear of the printer until the leading edge of paper comes out by 10 cm.

- 3 Lower the green lever.

- 4 Attach the receipt cover.

B: Installation using the **[RF]** key

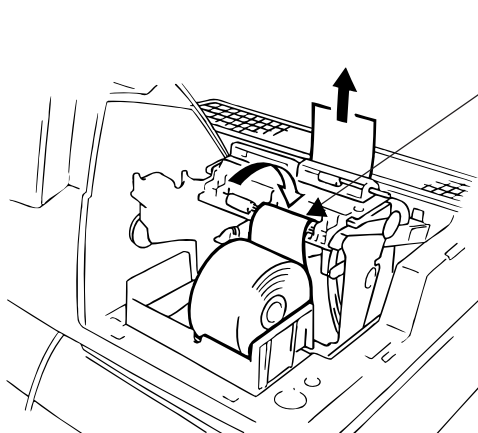

- 1 Insert paper from the rear of the printer until it won't go no further.

- 2 Press the **[RF]** key to feed paper until the leading edge of paper comes out by 10 cm.

- 3 Attach the receipt cover.

Installing the Journal Roll



Follow Steps 1 to 5 for "Installing the Receipt Roll" on the preceding pages, except that the paper roll should be placed inner side holder of the two holders.



There are the following two ways of a journal paper feed procedure.

A: Manual installation

B: Installation using the **[JF]** key

A: Manual installation

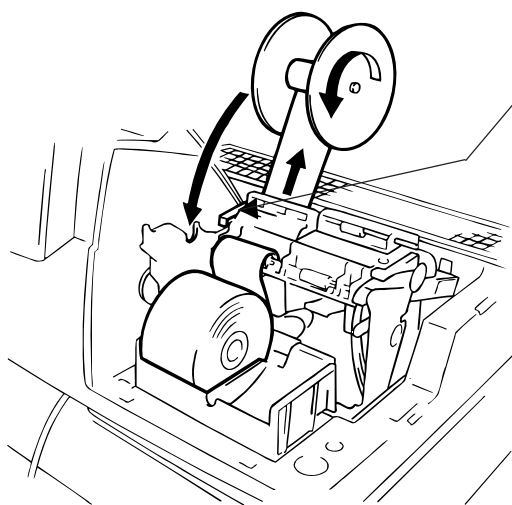

- ① Lift the green lever on the journal side.
- ② Insert paper from the rear of the printer until the leading edge of paper comes out by 30 cm.
- ③ Insert the leading edge of paper into the slit of the take-up reel to take up paper two or three times.
- ④ Place the take-up reel on the take-up holder.
- ⑤ Lower the green lever.
- ⑥ Attach the receipt cover.

B: Installation using the **[JF]** key

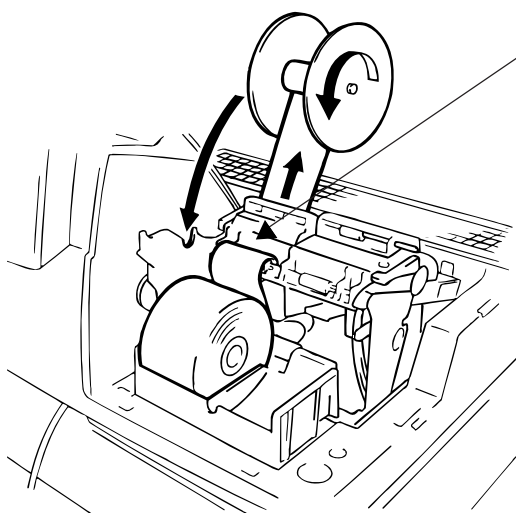

- ① Insert paper from the rear of the printer until it won't go no further.
- ② Press the **[JF]** key to feed paper until the leading edge of paper comes out by 30 cm.
- ③ Insert the leading edge of paper into the slit of the take-up reel to take up paper two or three times.
- ④ Place the take-up reel on the take-up holder.
- ⑤ Attach the receipt cover.

Setting the Ribbon Cassette

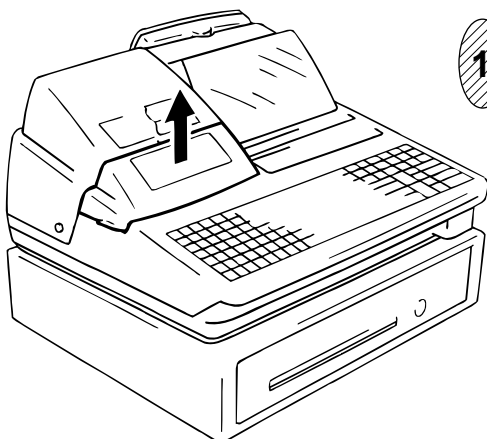

1 Detach the Ribbon Cover.

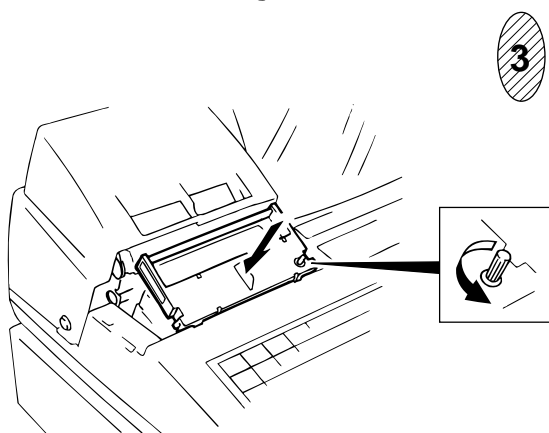

3 Set the Ribbon Cassette.
After setting the Ribbon Cassette, turn the knob of the Ribbon Cassette in the arrow direction several times to remove the slack on the ribbon.

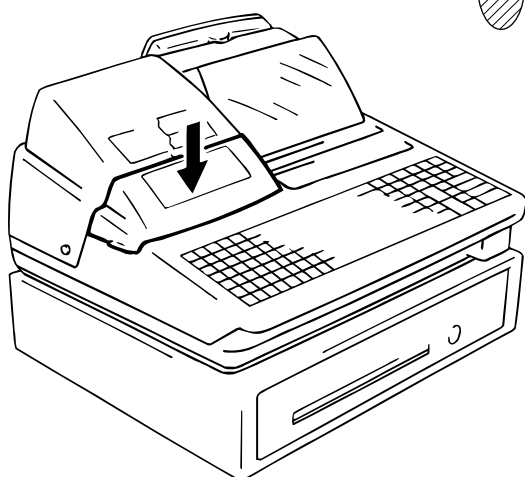

4 Attach the Ribbon Cover.

7. CASHIER SIGNING OR CASHIER KEY OPERATIONS

The FS-1450 adopts one of the following cashier-identifying operations.

- CODE ENTRY METHOD, using the [LOG/RECEIPT] (or [LOG]) key.
- CASHIER KEY METHOD, (hardware option), using Cashier Keys.
- CASHIER KEY METHOD, using [CLK] keys.

7.1. CODE ENTRY METHOD

Each cashier will sign-ON, sign-OFF, sign-IN, and sign-OUT through the [LOG/RECEIPT] (or [LOG]) key.

OPERATION: Mode Lock: REG (or, MGR or with Manager Intervention)
 ([LOG/RECEIPT] = [LOG])

(1) For single-drawer Machines

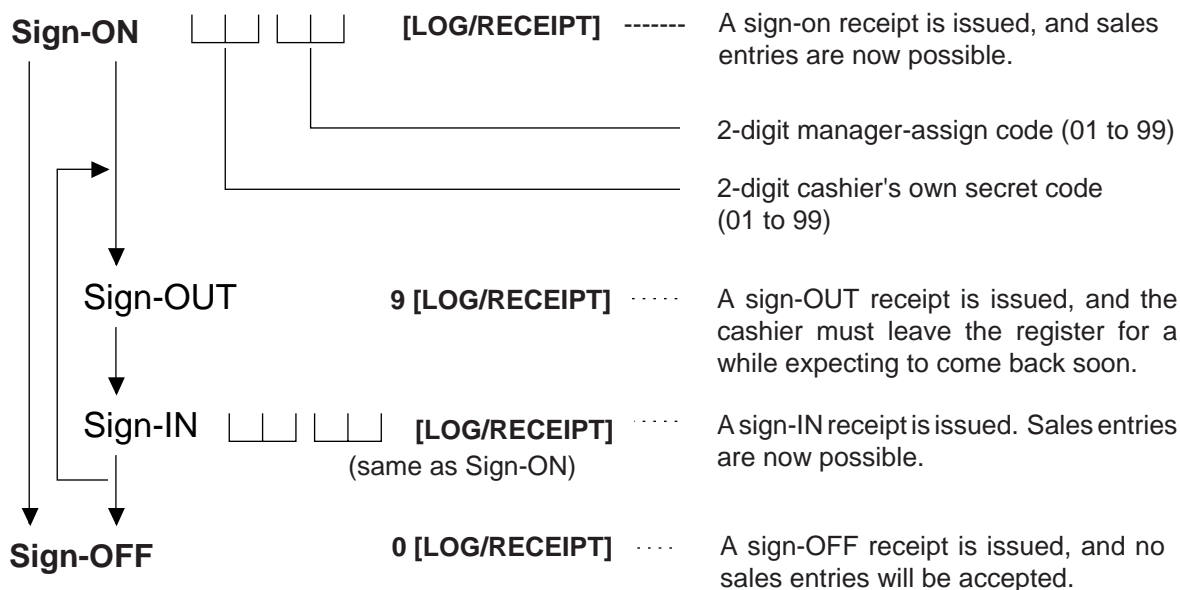

Sign-ON..... to be operated to start the job.

Sign-OUT to be operated to leave the register for a while expecting to come back soon.

Sign-IN to be operated when the cashier comes back from a break declared by Sign-OUT.

Sign-OFF..... to be operated to end the job.

- NOTES:**
1. *Sign-OUT may automatically be performed without operating "9 [LOG]" on finalizing each transaction including Check (or other non-cash media) Cashing, No-sale Exchange from/to Foreign Currencies, No-sale, Received-on-Account, Paid-Out, Loan, and Pick Up if so set by a program option. When this option is selected, Sign-IN is always necessary before starting every transaction.*
 2. *When the finalizing media key is programmed with Validation Compulsory or Endorsement Compulsory status, the automatic Sign-OFF or Sign-OUT will be executed after taking the validation or endorsement print of the media data.*

(2) For Multi-drawer Machines

Operations are basically the same as those for Single-drawer Machines, except that a one-digit drawer No. is entered through the [@/FOR] key prior to the Sign-ON entry:

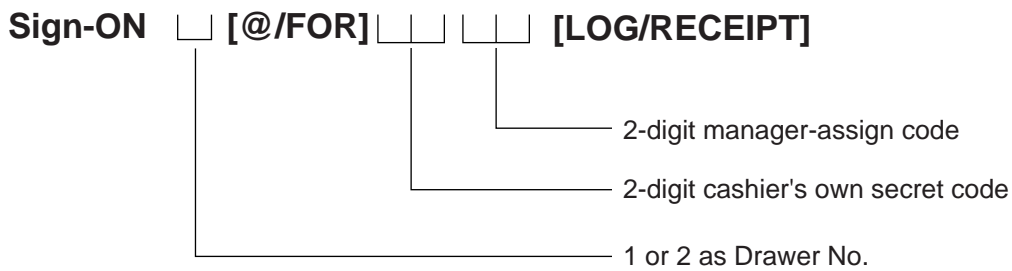

By entering a Drawer No., the designated drawer will open on finalizing each sale by that cashier. It will cause an error if a Drawer No. already used by another cashier is entered.

Sign-OUT
Sign-IN
Sign-OFF

} Same as those for Single-drawer machines.

(3) Mode Changes With Signing Operations

When **Signed-ON** or **Signed-IN**:

The Mode Lock position changes are allowed within "LOCK", "REG", "MGR", and "☐". Changing to any other position will be an error.

When **Signed-OUT**:

The Mode Lock may be turned to any position. However, cashier reports of the cashier being signed OUT cannot be taken in the "X" or "Z" position.

When **Signed-OFF**:

The Mode Lock may be turned to any position. Therefore, it is best for the cashier (or all the cashiers on a Multi-drawer Machine) to sign OFF before the Mode Lock is turned to the "LOCK", "X", "Z" or "SET" position.

-- SIGNING OPERATION RECEIPT PRINT FORMAT SAMPLES --

<p>TEC STORE 1343 PEACH DRIVE PHONE : 87-6437</p> <p>Open 8:00am to 7:00pm Closed : every Wednesday</p> <p>19-12-1994 MON #3001</p> <p>* S I G N O N *</p> <p>JONES 0062 15:30TM</p>	<p>TEC STORE 1343 PEACH DRIVE PHONE : 87-6437</p> <p>Open 8:00am to 7:00pm Closed : every Wednesday</p> <p>19-12-1994 MON #3001</p> <p>* S I G N O U T *</p> <p>JONES 0070 15:36TM</p>
<p>* S I G N O F F *</p> <p>JONES 0063 15:30TM</p>	<p>* S I G N I N *</p> <p>JONES 0071 15:30TM</p>

NOTE: A program option provides a selection not to print nor issue receipts on any signing operation.

7.2. CASHIER KEY METHOD (Hardware Option)

When the [LOG/RECEIPT] (or [LOG]) key is not installed, the Push-stay Cashier Keys may be provided at the side of the Mode Lock:

Push-stay Cashier Locks and Keys

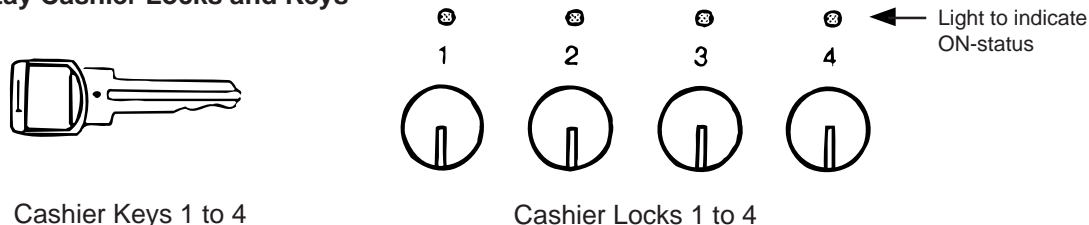

Each key is assigned to each cashier. The register will not operate in the "REG", "MGR", or "☐" mode unless one of these keys is inserted and pushed on or pushed-and-locked at the corresponding Cashier Lock. The light is lit when the key is in the ON-status.

Each of the keys may be inserted and pulled out in the neutral position marked with "1" to "4" in the above figure, and two ways are provided to set the Cashier Key to ON status:

PUSH-ON

When simply pushed on and released, the Cashier Key is set to ON status. This ON condition will be cleared by any of the following conditions:

- 1) when no key-in operations follow in three seconds.
- 2) when the transaction is finalized.
- 3) when another Cashier Key is pushed-on when outside a sale.
- 4) when the Mode Lock is turned to another position.

PUSH-AND-LOCK

When pushed and turned to the right, the ON status is locked until it is turned back to release and another Cashier Key is set to ON.

When another Cashier Key is attempted to push-and-lock, the register will entirely be locked.

If a Cashier Key has already been set to ON and a sale is under way, another Cashier Key will be disregarded if attempted to ON.

Under the CASHIER KEY METHOD, no receipts are issued, nor will the drawer open by setting a cashier key to the ON status.

The multi-drawer feature may be taken with the Push-stay Cashier Keys. In this case, each of the drawers 1 and 2 are assigned to Cashier 1 and Cashier 2, respectively. (No drawers for Cashiers 3 and 4.)

The "SIGN ON" triangular lamp will not be lit in any occasion under the cashier key method. The light attached to each Cashier Lock will be lit instead.

7.3. CASHIER KEY METHOD ([CLK] Keys)

When the [LOG/RECEIPT] (or [LOG] key is not installed, [CLK 1] to [CLK 8]; max. 8 keys may be provided on the ECR keyboard.)

Sale entries will be possible only when one of the [CLK] keys is depressed (in "REG", "MGR", or "☐" mode). When the same [CLK] key is again depressed, the cashier is in Cashier OFF status.

A program option provides a selection to display or not display the ON-status cashier code (1 to 8) at the "DPT" digit on the Operator Display.

The multi-drawer feature may be taken with the [CLK] keys. In this case, each of the drawers is assigned to the cashier of the following keys.

Drawer 1 to [CLK 1]

Drawer 2 to [CLK 2]

No drawers for [CLK 3] to [CLK 8]

-- Cashier ID Print on Sale Receipts --

On every sale receipt (issued in "REG", "MGR", or "☐" mode), the name of the cashier who has operated the entries of the sale is printed. The cashier name is programmable corresponding to each manager-assign cashier code (under the CODE ENTRY METHOD) or Cashier Key No. (under the CASHIER KEY METHOD).

```

TEC STORE
1343 PEACH DRIVE
PHONE : 87-6437

Open 8:00am to 7:00pm
Closed : every Wednesday

19-12-1994 MON #3001

VEGETABLE      $3.00TF
FRUIT           $1.30TF
TAX             $0.26
CASH           $ 4.5 6

ITEM      2
JONES    _____ 0070 15:45TM

```

Cashier's Name _____

7.4. TRAINING MODE START AND END

When you have newly employed cashiers, you may provide some time for them to train their skills of operating the FS-1450. You are to start and end the Training Mode. Once entering the Training Mode, a cashier may operate just as ordinary sale entry operations. The data in the Training Mode are processed into the training cashier memory but not affect any actual sales data in business.

CONDITION

Outside a sale, and in Cashier Signed-OFF condition for CASHIER CODE ENTRY Method

OPERATION FOR TRAINING MODES START

■ Code Entry Method

[LOG/RECEIPT] (or **[LOG]**) A training-ON receipt is issued.
 └───┬───┘
 └───┬───┘ 2-digit manager-assign code of a cashier with Training status (01 to 99)
 └───┘ 2-digit cashier's secret code (01 to 99)

■ Cashier Key Method

Case 1: Set the Cashier Key programmed with Training status

Case 2: 99 → **[LOG/RECEIPT]** (or **[LOG]**) A training-ON receipt is issued.
 └───┘ Fixed to 99 for training purposes.

ENTRIES IN TRAINING MODE

Registering operation are allowed by the trainees:

- All sale or transaction entry operations are possible in the Training Mode, except:
 - 1) The drawer will not open.
 - 2) The Consecutive No. on the receipt will not be incremented.
 - 3) Validation or Endorsement print is not available.
 - 4) Print occurs on receipt but not journal.

OPERATION FOR TRAINING MODE END

■ Code Entry Method, and Cashier Key Method Case 2

0 → **[LOG/RECEIPT]** (or **[LOG]**) A training-OFF receipt is issued in both cases.

■ Cashier Key Method Case 1

Change from the current Cashier Key to another Cashier Key.

Now the register is in a Signed-OFF condition. You may turn the Mode Lock to any position for its corresponding operations. To start sale entries, a cashier's sign-ON status is again necessary.

-- Training Mode Receipt Format --

Training Start (training Sign-ON) Receipt -----> Training End (Training Sign-OFF) Receipt

```
19-12-1994 MON #3001
* TRAINING *
*   ON   *
BROWN      0079 15:51TM
```

Training Mode Header

Receipt issued in Training Mode

```
19-12-1994 MON #3001
* TRAINING *
DAIRY          $2,30TF
Cheese-Half Pck $2,50TF
TAX             $0.29
CASH           $ 5,09
ITEM           2
* TRAINING *
BROWN          0079 15:51TM
```

Entry Contents

```
19-12-1994 MON #3001
* TRAINING *
*   OFF  *
0079 15:51TM
```

8. KEYBOARD LAYOUT

The following is typical keyboard layouts for the FS-1450 series. Since this series is designed to be capable of programming most of the keys to be placed in the desired place on the keyboard, this is merely example. The keyboard of your register should have its own layout according to the store's requirements.

---Flat Keyboard (US Standard) ---

PLU Preset-code Keys												Department Keys (Department Preset-code Keys)									
1	8	15	22	29	36	43	50	57	64	71	78										
2	9	16	23	30	37	44	51	58	65	72	79										
3	10	17	24	31	38	45	52	59	66	73	80										
4	11	18	25	32	39	46	53	60	67	74	81				7	8	9				
5	12	19	26	33	40	47	54	61	68	75	82				4	5	6				
6	13	20	27	34	41	48	55	62	69	76	83				1	2	3				
7	14	21	28	35	42	49	56	63	70	77	84				0	00	.				

		1	8	#	VOID	ITEM CORR	ALL VOID	LOG RECEIPT	RECEIPT ISSUE	RF	JF
		2	9		TX1/M	TX2/M	PR OPEN	LC OPEN	NS	DOLL DISC	R/A
		3	10		C		@/FOR	TAKE OUT	EAT IN	VALI DATE	PO
		4	11		7	8	9	TOTAL	MISC TEND	1.00 CASH (FUNCTION 1)	
		5	12	AMT	4	5	6		CHK TEND	5.00 CASH (FUNCTION 2)	
		6	13	PLU	1	2	3	AT/TL	ST	10.00 CASH (FUNCTION 3)	
		7	14		0	00	.		TXBL TL	20.00 CASH (FUNCTION 4)	

Other keys not placed in the keyboard above:

Additional Department keys (15 to 60)

[000] (Triple-zero Key)
[BTL RTN]
[% +]
[% -]
[OPEN]
[VND CPN]
[STR CPN]
[RTN MDSE]
[TX3/M], [TX4/M]
[TAX], [EX]

[SI1/M], [SI1/TL]
[SI2/M], [SI2/TL]
[RPT]
[PB]
[FS/M]
[FS TL/TEND]
[CARD No.]
[GST/M]
[RECALL]









[CUR 1] to [CUR 5]
[LOG]
[RECEIPT]
[CHECK No.]
[DP#]
[CPN]
[Chg]
[CREDIT 1] to [CREDIT 4]
[FUNCTION 5] to [FUNCTION 10]
[GCP LINE #]

[CHG TIP]
[TIP PAID]
[SALES PERSON]
[TRAY TL]
[CALL NO.]
[GUEST NO.]
[PRICE SHIFT 1] to [PRICE SHIFT 3]
[MENU SHIFT 1] to [MENU SHIFT 3]
[CLK 1] to [CLK 8]

9. FUNCTIONS OF EACH KEY

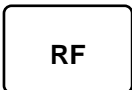
This section briefly describes functions of each key for your quick reference purposes. See the reference pages in Section 10: REGISTERING PROCEDURE AND PRINT FORMAT for detail operation sequences.

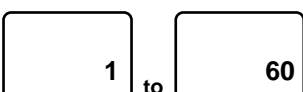
TABLE OF KEY FUNCTIONS

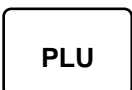
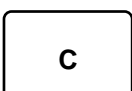
KEY	FUNCTIONS	REFERENCE PAGE
	LOG key. Used in case of Cashier Code Entry method, to declare start or end of normal operation by cashier. For details, refer to Section 7.1.	12
	Receipt key. Used to change the receipt-ON/OFF mode.	28
	Log/Receipt key. This is a dual-function key that has both [LOG] and [RECEIPT] functions.	See pages for [LOG] and [RECEIPT]
	Receipt Post-issue key. Used to issue the receipt of a sale when the sale has already finalized in the Receipt-OFF mode.	52
	Receipt Feed key. Used to advance the receipt roll and operated by holding it down until the paper has advanced to the required position.	—
	Journal Feed key. Used to advance the journal roll in the same fashion as the [RF] key is used to receipt roll.	—
	Numeric keys. Used to enter numeric values. Depressing the [00] key once is the same as depressing the [0] key twice consecutively. Depressing the [000] key once is the same as depressing the [0] key three times consecutively. The [.] key is used to designate the decimal point of a percentage rate or a quantity.	—
	Department keys. Used to enter each item, serving for classifying merchandise by department.	29
	Department No. key. Used to access a department by designating the department code, instead of depressing the specific Department key.	See pages for [DEPT]
	PLU (Price-Look-Up) key. Used to enter a PLU that is linked to a department.	30
	Clear key. Used to clear numeric entries or a declaration key entry.	—

KEY	FUNCTIONS	REFERENCE PAGE
#	Non-add Number Print key. Used to print a non-add number (such as Customer No., Credit Card No., etc.) on the receipt and journal for future reference.	41
NS	No-sale key. Used to open the cash drawer without relating a sale.	28
AMT	Amount key. Used to enter a manual amount of PLU item. And also used to enter an amount or price for an open department when the department is accessed by the [DP#] key.	29
PR OPEN	Preset Open key. Used to release a preset-price department or PLU items for a manual price entry.	29
LC OPEN	Listing Capacity Open key. Used to release the high or low amount limit preprogrammed on each department or PLU.	42
OPEN	Preset and Listing Capacity Open key. This is a dual-function key that has both [PR OPEN] and [LC OPEN] functions.	See pages for [PR OPEN] and [LC OPEN]
@/FOR	AT-FOR (Quantity Extension and Split Package Pricing) key. Used to multiply a department, PLU, or Bottle Return item entry by a quantity. Also used to auto-calculate and enter a split-package price.	31
VND CPN	Vendor Coupon key. Used to enter the amount of vendor coupons received from the customer.	40
STR CPN	Store Coupon key. Used to subtract a store coupon amount redeemed through a department.	40
RTN MDSE	Returned Merchandise key. Used to refund money to a customer who has returned items already purchased.	38
BTL RTN	Bottle Return key. Used to enter a bottle return amount.	38
DOLL DISC	Dollar Discount key. Used to subtract an amount from the sale such as a discount during a sale.	39
% +	Percent Charge key. Used to add a percent rate to a sale.	39

KEY	FUNCTIONS	REFERENCE PAGE
% -	Percent Discount key. Used to subtract a percent rate from a sale.	39
ITEM CORR	Item Correct key. Used to remove the last item from the bill, printing a line through the item on the receipt and journal.	40
VOID	Void key. Used to delete an item entered previously (before the last item) in the current transaction.	41
ALL VOID	All Void key. Used to cancel all the items entered in the current sale.	41
R/A	Received-on-Account key. Used to enter payments received on account, i.e. not relating to a sale. Also used for change reserve amounts loaned from the store.	29,49
PO	Paid-Out key. Used to record amounts paid out of the cash drawer not relating to a sale. Also used for Pick Up operations, such as money collections for banking purposes.	49, 5 (MG)
ST	Subtotal key. Used to obtain subtotal of the current transaction.	43
TXBL TL	Taxable Total key. Used to obtain the taxable total (the sale total including taxes due) of the current transaction.	43
AT/TL	Cash Amount Tendered/Cash Total key. Used to record all cash paid transactions and will be able to finalize a sale operation.	45
CHK TND or CHECK TEND	Check key. This is one of non-cash media keys, and used to cash a check when the register is outside a sale, or to finalize the transaction as a check payment.	45
Chg	Charge key. This is another non-cash media key, and usually programmed as "Charge Sale Total" key. This key can also be used for payments in credit cards, if the [CARD No.] key is installed.	See pages for [CHECK TEND]
MISC or MISC TEND	Miscellaneous Media key. This is one of additional non-cash media keys that may be installed besides [CHK TND] and [Chg] . This key has the same functions and programmabilities as the [CHK TND] key, and usually used as Tender-only key.	See pages for [CHECK TEND]

KEY	FUNCTIONS	REFERENCE PAGE
<div style="text-align: center; border: 1px solid black; padding: 5px; width: fit-content; margin: 0 auto;">CPN</div> <div style="display: flex; justify-content: space-around; margin-top: 10px;"> <div style="border: 1px solid black; padding: 2px 5px; text-align: center;">CREDIT 1</div> to <div style="border: 1px solid black; padding: 2px 5px; text-align: center;">CREDIT 4</div> </div>	<p>Media-coupon, Credit 1 to Credit 4 keys. These are additional non-cash media keys that may be installed besides those already described, according to the requirements of each store.</p>	<p>See pages for [CHECK TEND]</p>
<div style="border: 1px solid black; padding: 5px; text-align: center; width: fit-content; margin: 0 auto;">CARD No.</div>	<p>Card No. key. Used to enter the code number (1 to 12) which classifies the credit card company followed by the sale finalization with the [Chg] key.</p>	<p>45</p>
<div style="border: 1px solid black; padding: 5px; text-align: center; width: fit-content; margin: 0 auto;">VALI DATE</div>	<p>Validation key. Used to print a required item or finalizing a required sale on a validation slip.</p>	<p>55</p>
<div style="border: 1px solid black; padding: 5px; text-align: center; width: fit-content; margin: 0 auto;">CHECK No.</div>	<p>Check No. and Endorsement Print key. Used to print the endorsement data with or without a Check No. print after finalizing a sale with a non-cash media key.</p>	<p>56</p>
<div style="border: 1px solid black; padding: 5px; text-align: center; width: fit-content; margin: 0 auto;">PB</div>	<p>Previous Balance key. Used for a previous balance entry.</p>	<p>36</p>
<div style="text-align: center; margin-bottom: 5px;"> <div style="border: 1px solid black; padding: 2px 5px; display: inline-block;">SI/TL</div> or: </div> <div style="display: flex; justify-content: space-around; margin-top: 5px;"> <div style="border: 1px solid black; padding: 2px 5px; text-align: center;">SI1/TL</div> <div style="border: 1px solid black; padding: 2px 5px; text-align: center;">SI2/TL</div> </div>	<p>SI (Selective Itemizer) Total key. Used to display (and print) the selective itemizer contents.</p>	<p>44</p>
<div style="text-align: center; margin-bottom: 5px;"> <div style="border: 1px solid black; padding: 2px 5px; display: inline-block;">SI/M</div> or: </div> <div style="display: flex; justify-content: space-around; margin-top: 5px;"> <div style="border: 1px solid black; padding: 2px 5px; text-align: center;">SI1/M</div> <div style="border: 1px solid black; padding: 2px 5px; text-align: center;">SI2/M</div> </div>	<p>SI (Selective Itemizer) Modifier key. Used to reverse the SI (Selective Itemizer) status programmed on each Department or PLU.</p>	<p>42</p>
<div style="text-align: center; margin-bottom: 5px;"> <div style="border: 1px solid black; padding: 2px 5px; display: inline-block;">TX/M</div> or: </div> <div style="display: flex; justify-content: space-around; margin-top: 5px;"> <div style="border: 1px solid black; padding: 2px 5px; text-align: center;">TX1/M</div> to <div style="border: 1px solid black; padding: 2px 5px; text-align: center;">TX4/M</div> </div>	<p>Tax Modifier key(s). Used to reverse the taxable/non-taxable status on departments, PLUs, or other tax-status programmable keys. Also used in Tax Exempt operations.</p>	<p>42</p>
<div style="border: 1px solid black; padding: 5px; text-align: center; width: fit-content; margin: 0 auto;">EX</div>	<p>Tax Exempt key. Used to declare the exemption of the taxes from the sale.</p>	<p>44</p>

KEY	FUNCTIONS	REFERENCE PAGE
<div style="border: 1px solid black; padding: 2px; display: inline-block; text-align: center;">SALES PERSON</div>	Salesperson key. Used to record sales contribution data of each salesperson for report purpose.	50
<div style="border: 1px solid black; padding: 2px; display: inline-block; text-align: center;">RPT</div>	Repeat key. Used to repeat a department or PLU item entry.	30
<div style="display: flex; align-items: center; gap: 5px;"> <div style="border: 1px solid black; padding: 2px; display: inline-block; text-align: center;">CUR 1</div> to <div style="border: 1px solid black; padding: 2px; display: inline-block; text-align: center;">CUR 5</div> </div>	Foreign Currency keys. Used in tendering or exchange with foreign currencies.	47
<div style="border: 1px solid black; padding: 2px; display: inline-block; text-align: center;">TAX</div>	Manual Tax key. Used to enter an irregular tax amount that cannot be calculated on the basis of the programmed tax table, and to add it to the sale total.	43
<div style="border: 1px solid black; padding: 2px; display: inline-block; text-align: center;">FSTL TEND</div>	Food Stamp Total Read/Tender key. Used to read the Food Stampable portion amount of the sale and to tender an amount in Food Stamps.	45
<div style="border: 1px solid black; padding: 2px; display: inline-block; text-align: center;">FS/M</div>	Food Stamp Modifier key. Used to reverse the Food Stampable/Non-stampable status of a Department, PLU, and other function keys programmable with food-stampable status.	42
<div style="border: 1px solid black; padding: 2px; display: inline-block; text-align: center;">GST/M</div>	GST Modifier key. Used to reverse the GST taxable/Non-taxable status of Department, PLU, and other function keys programmable with GST tax status.	42
<div style="display: flex; align-items: center; gap: 5px;"> <div style="border: 1px solid black; padding: 2px; display: inline-block; text-align: center;">CLK 1</div> to <div style="border: 1px solid black; padding: 2px; display: inline-block; text-align: center;">CLK 8</div> </div>	Cashier 1 to Cashier 8 keys. Used to declare start or end of normal operation by cashier (instead of using [LOG/RECEIPT] (or [LOG]) key).	16
<div style="display: flex; align-items: center; gap: 5px;"> <div style="border: 1px solid black; padding: 2px; display: inline-block; text-align: center;">FUNCTION 1</div> to <div style="border: 1px solid black; padding: 2px; display: inline-block; text-align: center;">FUNCTION 10</div> </div>	Function 1 to Function 10 keys. Used to execute a command of key string preprogrammed on each of these keys. An operation series of maximum 10 keys can be programmed on each key, thus eliminating time in daily operation routines.	50
PLU Preset-code Keys	Each of these keys is programmed with a PLU Code. That is, depressing one of those keys is equal to entering a PLU Code then depressing the [PLU] key.	See pages for [PLU]

KEY	FUNCTIONS	REFERENCE PAGE
TOTAL	Total key. Used to finalize the sales entries and transfer all the balance.	36
TRAY TOTAL	Tray Total key. Used to obtain the total of an individual guest tray in a guest party.	53
CHARGE TIP	Charge Tip key. Used to enter a tip amount for cashier.	51
TIP PAID	Tip Paid key. Used to enter a cash tip amount for cashier.	51
GCP LINE #	GCP Line No. key. Used to enter the number of printed lines for accessing the appropriate position to print additional data on a guest check.	37
GUEST NO.	Number-of-Guests key. Used to enter the number of guests.	42
CALL No.	Call No. key. Used to enter the call No. of order taking.	54
PRICE SHIFT 1 to PRICE SHIFT 3	PLU Price Shift key. Used to shift the PLU code.	34
MENU SHIFT 1 to MENU SHIFT 3	PLU Menu Shift key. Used to designate the keyboard No. for Preset-code PLU.	34
RECALL	Recall key. Used to recall the order table.	55

10. REGISTERING PROCEDURE AND PRINT FORMAT

Before starting sale entries, read through the following instructions:

WARNING!
<i>When opening the cash drawer, be careful not to let the drawer hit any person.</i>

TRAINING MODE is available:

If you are a beginner in operating this register, ask the store manager for practicing in the TRAINING MODE.

During your operations, the following may occur:

- **Errors ...**

A tone continuously sounds and the keys on the keyboard are locked. In this case, depress the **[C]** key to cancel the error status. Then remove the cause of the error and perform the operation again.

- **Other errors requiring Manager Intervention ...**

When an error occurs and you cannot think of the cause or the same error occurs again, call your manager.

- **Receipt or Journal Paper-End is detected ...**

When an error tone sounds and the "AMOUNT" portion of the display is flickering, the receipt or journal roll is about to end. In this case, the error cannot be canceled by the **[C]** key. Replace the paper roll with a new one, referring to the paper installing/removing operations in Chapter 15 and Chapter 6.

- **Printer Motor-Lock Condition is detected ...**

If "Error" is indicated in the display panel ("AMOUNT" portion), the Printer Motor is locked due to paper jam, etc. Turn the Power Switch to OFF, and remove the cause of the motor-lock. Refer to Chapters 12 and 13.

CONDITION SETTING TO START TRANSACTION ENTRIES

Mode Lock: Insert the "REG" key and set it to the **"REG"** position.

Cashier Sign-ON or Cashier Key to ON status:

If the **[LOG/RECEIPT]** (or **[LOG]**) key is installed, you must sign-ON or sign-IN. (See Section 7.1.)

If Cashier Keys or Cashier Locks are installed, you must set your cashier key to the ON status. (See Section 7.2. and 7.3.)

Now you are ready for sale entries.

On the following pages are patterns of entering operations, and receipt or journal print format samples due to the operations. In the operation sequence patterns, " " indicates an input through the numeric keys, "[]" indicates a depression of the function key, and "---" indicates other registering and/or finalizing operations.

Please note that these are merely sample operations. Especially, the receipt or journal print indications merely show the standard print format. The actual print format and contents may vary on your machine in accordance with the differences in specification, program selections, etc.

TABLE OF CONTENTS

<u>OPERATION</u>	<u>PAGE</u>	<u>OPERATION</u>	<u>PAGE</u>
RECEIPT-ISSUE/NON-ISSUE SELECTION	28	SUBTOTAL READ	43
NO-SALE	28	TAXABLE TOTAL READ	43
LOAN	29	TAXABLE TOTAL READ and SUBTOTAL PRINT	43
DEPARTMENT ENTRY	29	SELECTIVE ITEMIZER TOTAL READ	44
PLU ENTRY	30	TAX CALCULATION AND PRINT	44
SET MENU ENTRY	30	TAX EXEMPTION	44
REPEAT ENTRY	30	FOOD STAMPABLE TOTAL READ	
QUANTITY EXTENSION (MULTIPLICATION)		FOOD STAMP TENDERING	45
for DEPTs/PLUs	31	SALE FINALIZATION BY MEDIA KEYS	45
SPLIT PACKAGE PRICING	32	MULTI-TENDERING	46
PLU PRICE SHIFT ENTRY	34	SPLIT TENDERING	46
PLU MENU SHIFT ENTRY	34	CHECK CASHING	47
SINGLE-ITEM DEPARTMENT/PLU ENTRY	35	SALE PAID IN FOREIGN CURRENCIES	47
OTHER INCOME DEPARTMENT/PLU ENTRY	35	NO-SALE EXCHANGE from Foreign Currency	
ORDER ENTRY, PREVIOUS BALANCE ENTRY	36	to Domestic Currency	48
ADDITIONAL ORDER ENTRY	37	NO-SALE EXCHANGE from Domestic Currency	
RETURNED MERCHANDISE	38	to Foreign Currency	48
BOTTLE RETURN	38	RECEIVED-ON-ACCOUNT	49
DOLLAR DISCOUNT	39	PAID-OUT	49
PERCENT DISCOUNT, PERCENT CHARGE	39	SALESPERSON ENTRY	50
STORE COUPON	40	FUNCTION KEY ENTRY	50
VENDOR COUPON	40	TIP PAID	51
ITEM CORRECT	40	CHARGE TIP	51
VOID	41	RECEIPT POST-ISSUE	52
ALL VOID	41	TRAY TOTAL	53
NON-ADD NUMBER PRINT	41	EAT-IN/TAKEOUT ENTRY	53
NUMBER-OF-GUESTS ENTRY	42	CALL NO. ENTRY	54
LISTING CAPACITY OPEN	42	DRIVE-THROUGH ENTRY	54
SELECTIVE ITEMIZER STATUS MODIFICATION	42	RECALL ENTRY	55
TAX STATUS or FOOD STAMP STATUS		VALIDATION PRINT	55
MODIFICATION	42	ENDORSEMENT PRINT	56
MANUAL TAX ENTRY	43	GUEST CHECK PRINTER OPERATION	57
		WHEN A POWER FAILURE OCCURS	58

RECEIPT-ISSUE/NON-ISSUE SELECTION

Receipts are issued or not issued according to the "R OFF" lamp illuminated/extinguished status on the Operator Display panel.

"R OFF" (Receipt OFF) Lamp Status Change Operations ([LOG/RECEIPT] = [RECEIPT])

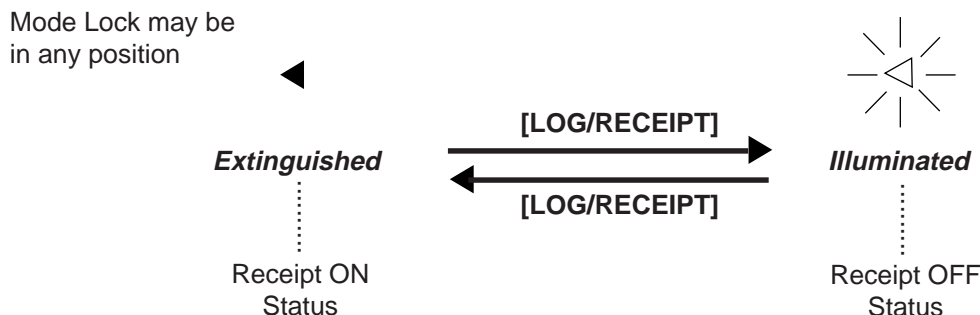

- NOTES:**
1. The "R OFF" lamp status at the starting of a transaction entry decides whether a receipt will be issued for the transaction or not. Switching the Receipt ON/OFF status during a transaction will not be effective.
 2. If a transaction entered with the "R OFF" lamp illuminated and finalized but a receipt is required, the **[RECEIPT ISSUE]** (Post-issue Receipt) key can be operated to issue a receipt.
 3. Simply depress the **[LOG/RECEIPT]** key without a numeric entry. If the key is depressed with a prior numeric entry in REG mode, it may turn out to be a Sign ON or Sign OFF operation (in case of Cashier Code Entry Method).

NO-SALE

The no-sale transaction is used to open the cash drawer without relating to any sales, such as for giving change, testing the receipt/journal print condition, etc.

OPERATION (must be operated outside a sale)

[NS]..... The drawer opens and a No-sale receipt is issued.

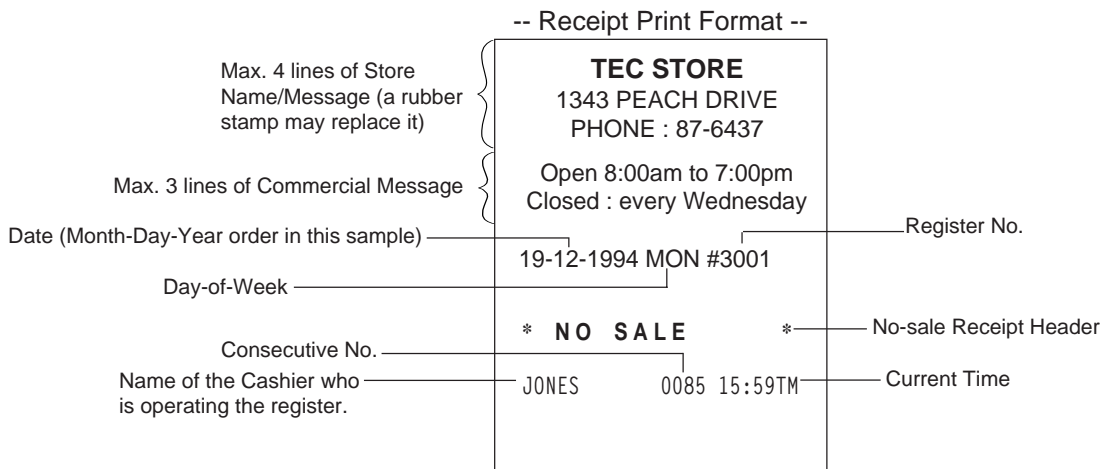

NOTE: The print format samples in this manual are not copies of actual receipts printed on an ECR but are merely indications of print formats. In those format samples, the bold-face characters indicate Double-sized Characters on actual receipts issued by the ECR. Also note that each Double-sized Character on actual receipts will be printed at the position half-character space rightward more than in the print format samples in this manual.

LOAN

This operation is used to record the cash amounts and food stamps loaned from the store as the change reserve in the drawer.

OPERATION (must be operated outside a sale)

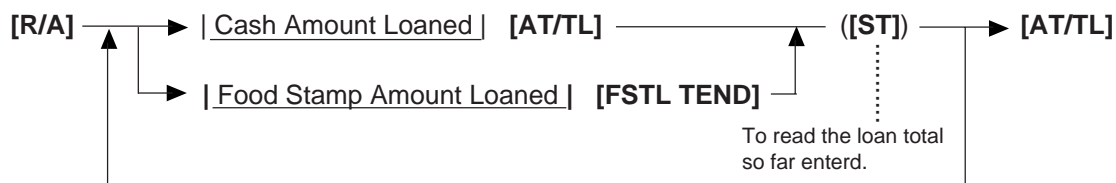

Repeatable to add up amounts.

-- Receipt Print Format --

Loan Receipt Header	* LOAN *	
Amounts loaned	CASH	\$20.00
	CASH	\$10.00
	CASH	\$35.00
	SUBTL	\$65.00
Total amount loaned	TOTAL	\$ 6 5 . 0 0
	JONES	0095 15:59TM

DEPARTMENT ENTRY

Each department is preprogrammed as the "PRESET" type (with a price programmed) or "OPEN" type (with no price programmed). Perform operation depending on the type selected.

OPERATION

Open Department Type

- |Price| [**Open DEPT**]
- |Open-Dept Code| [**DP#**] |Price| [**AMT**]

Preset Department Type

- [**Preset DEPT**]
- |Dept Code| [**DP#**]

Preset-price Open through Preset Department Type

- [**PR OPEN**] (or [**OPEN**]) |Price| [**Preset DEPT**]
- [**PR OPEN**] (or [**OPEN**]) |Dept Code| [**DP#**] |Price| [**AMT**]

-- Receipt Print Format --

VEGETABLE	\$1.00TF
-----------	----------

T: Taxable Item Symbol
 F: Food Stampable or GST Taxable Item Symbol

DP 13	\$1.40
-------	--------

DP 13	\$1.00
-------	--------

PLU ENTRY

Each PLU is preprogrammed as the "PRESET" type (with a price preset) or "OPEN" type (with no price preset). Perform operation depending on the type selected.

OPERATION

Open PLU Type

- | Open-PLU Code | **[PLU]** | Price | **[AMT]**
- | Price | **[PLU Preset-Code Key]** of Preset-PLU

Preset PLU Type

- | Preset-PLU Code | **[PLU]**
- **[PLU Preset-Code Key]** of Preset-PLU

Preset-price Open Entry through Preset PLU Type

- **[PR OPEN]** (or **[OPEN]**) | Preset-PLU code | **[PLU]** | Price | **[AMT]**
- **[PR OPEN]** (or **[OPEN]**) | Price | **[PLU Preset-Code Key]**

-- Receipt Print Format --

Potato Chips	\$1.50T
--------------	---------

Cheese	\$2.50TF
--------	----------

Hard Rolls-4	\$0.80TF
--------------	----------

SET MENU ENTRY

A maximum of 30 Set Menu Tables are programmable. In one table, a maximum of 8 Menu Items can be set. By entering the main menu, the sub menu are automatically entered.

OPERATION

Same operations as PLU Entry.

-- Receipt Print Format --

Beef Stk Set	\$14.50T
Veget. Salad>	
Corn Soup>	
Coffee>	

Sub Menu Mark

REPEAT ENTRY

To repeat the same item of the last entry, simply depress the last key of the department or PLU entry sequence or depress the **[RPT]** key.

OPERATION

(1) Department Repeat

Open Department Type

- | Price | **[Open DEPT]** | **[Same DEPT]** (or **[RPT]**)
- | Open-Dept Code | **[DP#]** | Price | **[AMT]** | **[AMT]** (or **[RPT]**)

Preset Department Type

- **[Preset DEPT]** | **[Same DEPT]** (or **[RPT]**)
- | Preset-Dept Code | **[DP#]** | **[DP#]** (or **[RPT]**)

Preset-price Open Repeat

- **[PR OPEN]** (or **[OPEN]**) | Price | **[Preset DEPT]** | **[RPT]**
- **[PR OPEN]** (or **[OPEN]**) | Preset-Dept Code | **[DP#]** | Price | **[AMT]** | **[RPT]**

-- Receipt Print Format --

VEGETABLE	\$1.20TF
VEGETABLE	\$1.20TF

(2) PLU Repeat

Open PLU Type

- | Open-PLU Code | **[PLU]** | Price | **[AMT]** | **[AMT]** (or **[RPT]**)
- | Price | **[PLU Preset-Code key]** | **[Same key]** (or **[RPT]**)

Preset PLU Type

- | Preset-PLU Code | **[PLU] [PLU]** (or **[RPT]**)
- **[PLU Preset-Code key] [Same key]** (or **[RPT]**)

-- Receipt Print Format --

Hard Rolls-4	£0,70TF
Hard Rolls-4	£0,70TF

Preset-price Open Repeat

- **[PR OPEN]** (or **[OPEN]**) | Preset-PLU Code | **[PLU]** | Price | **[AMT] [RPT]**
- **[PR OPEN]** (or **[OPEN]**) | Price | **[PLU Preset-Code key] [RPT]**

- NOTES:**
1. If the first item of those repeated is modified with **[SI/M]**, **[LC OPEN]**, **[FS/M]**, **[TX/M]**, or **[GST/M]**, the modified status will be effective through the last item of the repeated.
 2. Please note that the Preset-price Open Repeat using a **[Preset DEPT]** key or a **[PLU Preset-Code Key]** can only be repeated by the **[RPT]** key.
 3. A negative Department/PLU cannot be repeated. Neither can any Set Menu PLU be repeated.

QUANTITY EXTENSION (MULTIPLICATION) FOR DEPTs/PLUs**OPERATION****(1) Department Multiplication***Open Department Type*

- | Quantity | **[@/FOR]** | Price | **[Open DEPT]**
- | Quantity | **[@/FOR]** | Open-Dept Code | **[DP#]** | Price | **[AMT]**

Preset Department Type

- | Quantity | **[@/FOR]** | **[Preset DEPT]**
- | Quantity | **[@/FOR]** | Preset-Dept Code | **[DP#]**

Preset-price Open Type

- | Quantity | **[@/FOR]** | **[PR OPEN]** (or **[OPEN]**) | Price | **[Preset DEPT]**
- | Quantity | **[@/FOR]** | **[PR OPEN]** (or **[OPEN]**) | Preset-Dept Code | **[DP#]** | Price | **[AMT]**

(2) PLU Multiplication*Open PLU Type*

- | Open-PLU Code | **[PLU]** | Quantity | **[@/FOR]** | Price | **[AMT]**
- | Quantity | **[@/FOR]** | Price | **[PLU Preset-Code key]** of Open-PLU

Preset PLU Type

- | Quantity | **[@/FOR]** | Preset-PLU Code | **[PLU]**
- | Quantity | **[@/FOR]** | **[PLU Preset-Code key]** of Preset-PLU

Preset-price Open Type

- **[PR OPEN]** (or **[OPEN]**) | Preset-PLU Code | **[PLU]** | Quantity | **[@/FOR]** | Price | **[AMT]**
- | Quantity | **[@/FOR]** | **[PR OPEN]** (or **[OPEN]**) | Price | **[PLU Preset-Code key]** of Preset-PLU

- NOTES:** 1. Quantity Max. 3 integral + 3 decimal digits
 (Use the [.] key for entering decimal digits.)
 Price (Unit Price)... Max. 6 digits
 (5 digits for Preset Point Feature)
 Product Must not exceed 8 digits.

-- Receipt Print Format --

5X	1.30@	
DAIRY		\$6.50TF
6X	0.45@	
BAKERY		\$2.70TF

- When the Quantity is 1-digit integer (1 to 9) followed by a Code-preset Department/PLU key with a price preset, the [@/FOR] key is omissible.
- The product obtained by multiplication cannot be repeated.
- The decimal portion of the Quantity entry itself is processed down to the two digits below the decimal point. The fraction rounding in this case is fixed to ROUND OFF.
- You can select the rounding process of the fractions of the product (result of multiplication) by a program option: ROUND OFF (initial setting), ROUND UP, or ROUND DOWN.

SPLIT PACKAGE PRICING ("Q'ty" = Quantity... in the patterns listed below)

OPERATION

(1) Department

Open Department

- | Purchased Q'ty | [@/FOR] | Whole Package Q'ty | [@/FOR] |
 - | Whole Package Price | [Open Dept]
 - | Open-Dept Code | [DP#] | Whole Package Price | [AMT]

Preset Department

- | Purchased Q'ty | [@/FOR] | Whole Package Q'ty | [@/FOR] |
 - [Preset Dept]
 - | Preset-Dept Code | [DP#]

Preset-price Open

- [PR OPEN] (or [OPEN]) |
 - | Purchased Q'ty | [@/FOR] | Whole Package Q'ty | [@/FOR] |
 - | Whole Package Price | [Preset Dept]
 - | Preset-Dept Code | [DP#] | Whole Package Price | [AMT]

(2) PLU

Open PLU

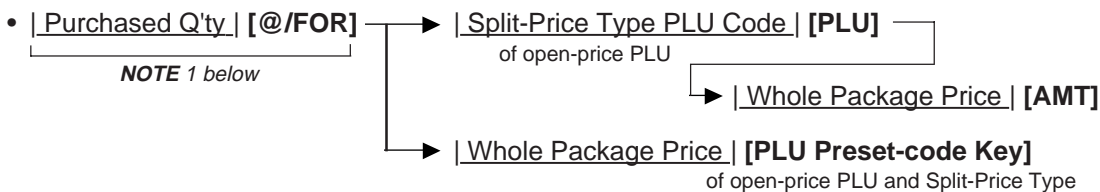

Preset PLU

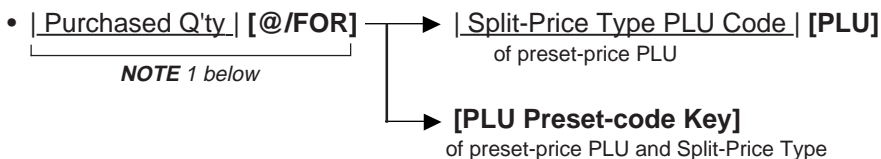

Preset-Price Open

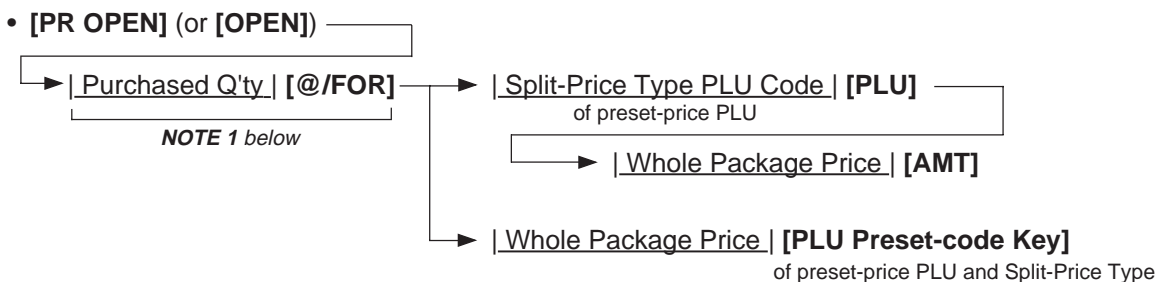

- NOTES:**
1. When this portion is omitted, the "Purchased Q'ty" value is regarded as "1" (i.e. one individual item but not the whole package quantity.)
 2. Purchased Quantity max. 3 digits integral only
 Whole Package Quantity max. 3 digits integral only
 Whole Package Price max. 6 digits
 3. One of two fraction rounding methods can be selected for the Split Package Pricing calculations -- Round Up PRODUCT (initial setting) or Round Up UNIT PRICE.

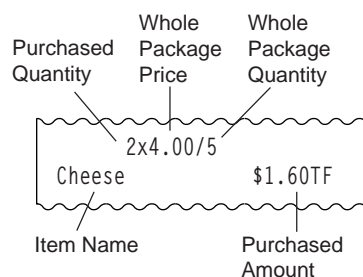

PLU PRICE SHIFT ENTRY

This operation is to register the PLU code which is added 1, 2, or 3 to the code of the entered PLU.

OPERATION

- [PRICE SHIFT 1] —————▶ [PLU] (PLU code plus 1)
- [PRICE SHIFT 2] —————▶ [PLU] (PLU code plus 2)
- [PRICE SHIFT 3] —————▶ [PLU] (PLU code plus 3)
- [PR OPEN] —————▶ [PRICE SHIFT 1 ~ 3] | PLU Code | [PLU] | Price | [AMT]

- NOTES:**
1. Error results when some operation other than PLU Price Shift entry is attempted after depressing the [PRICE SHIFT] key.
 2. Repeat entry after depressing the [PRICE SHIFT] key is unavailable.
 3. Program option allows an ECR to display PLU Price Shift No. together with PLU Menu No. instead of a department code.

PLU MENU SHIFT ENTRY

Max. 3 PLUs can be programmed on the respective PLU Preset-code keys of the flat keyboard. This operation designates the keyboard phase No.

OPERATION

- [MENU SHIFT 1] —————▶ [PLU] (PLU on keyboard phase No. 1)
- [MENU SHIFT 2] —————▶ [PLU] (PLU on keyboard phase No. 2)
- [MENU SHIFT 3] —————▶ [PLU] (PLU on keyboard phase No. 3)

- NOTES:**
1. After one PLU Menu Shift entry, the keyboard phase No. is automatically returned to the phase No. 1. However, the keyboard phase No. "Hold" spec. can be programmed by program option.
In this case, the keyboard phase No. can be shifted by the [MENU SHIFT] key only.
 2. Program option allows an ECR to display PLU Menu No. together with PLU Price Shift No. instead of a department code.

SINGLE-ITEM DEPARTMENT or SINGLE-ITEM PLU ENTRY

If a department (or PLU) is programmed as Single-item, the department (or PLU) entry sequence will immediately finalize the sale as cash sale when operated outside a sale.

OPERATION

Same as

DEPARTMENT ENTRY PLU ENTRY QUANTITY EXTENSION SPLIT PACKAGE PRICING SET MENU ENTRY
--

-- Single-item Receipt Print Format --

TEC STORE	
1343 PEACH DRIVE PHONE : 87-6437	
Open 8:00am to 7:00pm Closed : every Wednesday	
19-12-1994 MON #3001	
D P 14	\$2.10
CASH	\$ 2.10
ITEM 1	
JONES	0108 16:27TM

NOTE: *If operated inside a sale, it functions just as an ordinary itemized department or PLU.*

OTHER INCOME DEPARTMENT ENTRY, OTHER INCOME PLU ENTRY

This operation is used to enter items which do not directly become sales for the store, such as lottery, postage, gift wrapping fee, size adjustment fee, utility (payment of electricity and gas), and donation.

OPERATION

Same as DEPARTMENT ENTRY sequence using the Department Key which is programmed as an OTHER INCOME department. When a PLU is used for this purpose, the PLU must be programmed to link to a department with Other Income status.

ORDER ENTRY, PREVIOUS BALANCE ENTRY

OPERATION

Insert a slip into the Guest Check Printer (NOTE 1 below)

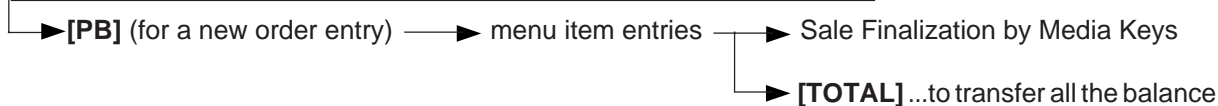

- NOTES:**
1. Previous Balance Entry can be executed even when a slip has not been inserted into the Guest Check Printer by a program option.
 2. Previous Balance Entry can be canceled. To end the entry, follow the procedure described below.

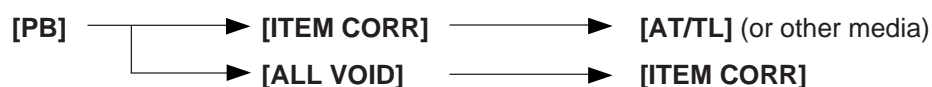

3. Previous Balance Entry is unavailable when the drive-through option is selected.

-- Receipt Print Format --

P B +	\$0.00
Hamb. Steak	\$7.50T
Veget. Salad	\$2.20T
Coffee	\$2.50T
TAX1	\$0.73
TAX2	\$0.13
CASH	\$13.06
ITEM	3
JONES	0021 13:48TM

-- Guest Check --

P B +	\$0.00
Hamb. Steak	\$7.50T
Veget. Salad	\$2.20T
Coffee	\$2.50T
TAX1	\$0.73
TAX2	\$0.13
CASH	\$13.06
ITEM	3
12-12-94 #111101	1CL0021 1130 13:48TM

ADDITIONAL ORDER ENTRY

OPERATION

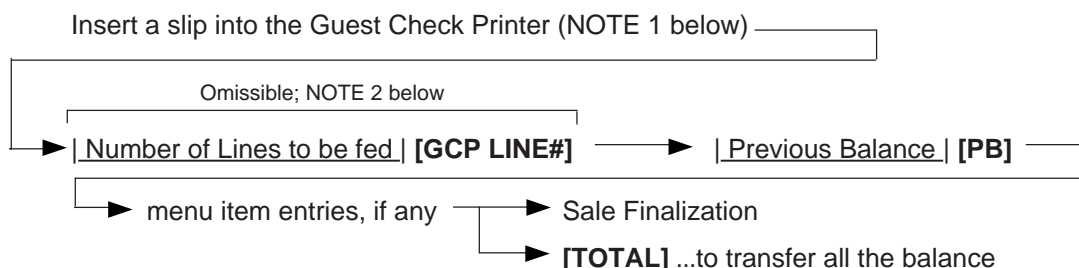

- NOTES:**
1. Previous Balance Entry can be executed even when a slip has not been inserted into the Guest Check Printer by a program option.
 2. When omitting the designation of the number of lines to be fed, lines will be fed with the preprogrammed value. When designating the number of lines to be fed, the specified number of lines to be fed should not exceed the preprogrammed maximum number of lines to be printed. For example, when 10 is input, the program feeds 10 lines and starts printing on the 11th line.

-- Receipt Print Format --

Order Entry

P B +		\$0.00
	2x 14.50@	
Beef Stk Set		\$29.00T
Veget. Salad>		
Corn Soup>		
Coffee>		
TAX1		\$1.74
TOTAL		\$30.74
ITEM	2	
JONES		0022 13:51TM

Additional Order

P B +		\$30.74
	2X 2.00@	
Ice Cream		\$4.00T
CASH		\$34.74
ITEM	2	
JONES		0023 13:56TM

-- Guest Check --

P B +		\$0.00
	2X 14.50@	
Beef Stk Set		\$29.00T
Veget. Salad>		
Corn Soup>		
Coffee>		
TAX1		\$1.74
TOTAL		\$30.74
ITEM		
13 12-19-94 #111101	1CL0021 1130	13:51TM
P B +		\$30.74
	2X 2.00@	
Ice Cream		\$4.00T
CASH		\$34.74
20 12-19-94 #111101	1CL0021 1130	13:51TM

RETURNED MERCHANDISE

OPERATION

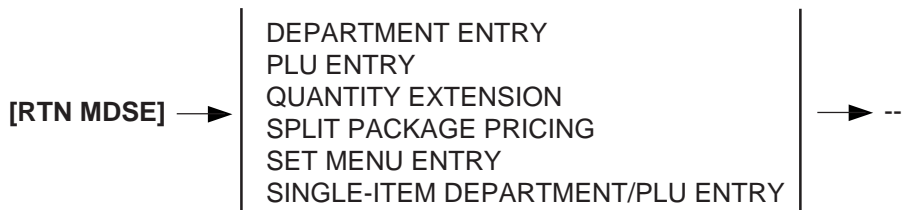

-- Receipt Print Format --

RTN	
BAKERY	-1.45TF
RTN	
CAN FOOD	-0.45TF

BOTTLE RETURN

OPERATION

| Bottle Return Amount | [BTL RTN]

| Quantity | [@/FOR] | Unit Amount | [BTL RTN]

└── max. 3 digit (integral value only)

NOTE: • *Must not exceed the sale total amount.... unless "Credit Balance" option is selected. (See REMARKS below.)*

REMARKS: *In using the [BTL RTN] key when the "Credit Balance" option is not selected:*

Bottle Return entry after a Department or PLU item

The bottle return amount must not exceed the preceding Department or PLU item amount.

Bottle Return entry after a subtotal

The bottle return amount must not exceed the subtotal amount.

(Operating the [BTL RTN] key after any other item ([%+], [%-], etc.) than those above, an error will result.)

-- Receipt Print Format --

BTR	-0.05
-----	-------

6X	0.05@
BTR	-0.30

DOLLAR DISCOUNT

OPERATION

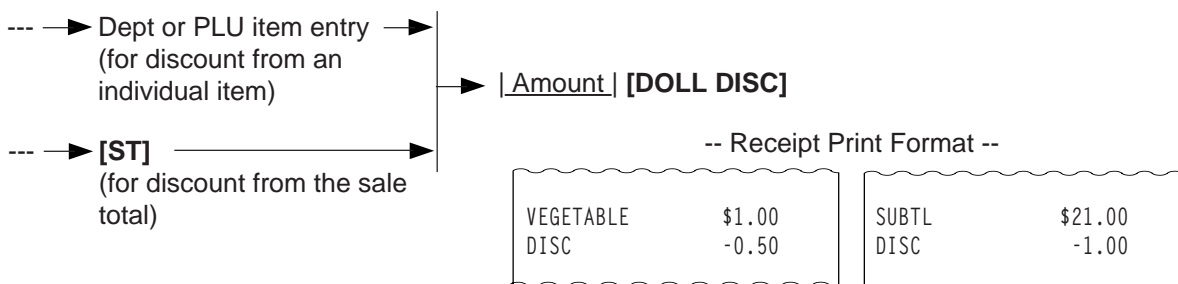

NOTES: The discount amount must not exceed the item amount or the subtotal unless the "Credit Balance" option is selected.

PERCENT DISCOUNT, PERCENT CHARGE (SERVICE CHARGE)

OPERATION

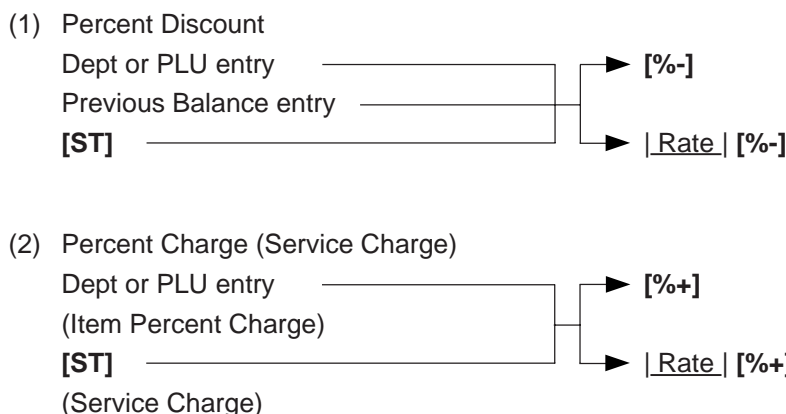

- NOTES:**
1. Rate 0.001 to 99.999 (%)
 2. When the Dept or PLU item entry is modified with [RTN MDSE] or [VOID], the following % entry will also be modified with [RTN MDSE] or [VOID].
 3. No % + entry is allowed immediately after the input of a PB amount.
 4. A % entry will cause an error if operated after an Other Income Department/PLU.

-- Receipt Print Format --

FISH	\$3.40TF	SUBTL	\$6.00
%-		%-	
5%	-0.17T	10%	-0.60

STORE COUPON

OPERATION

[STR CPN] → Follow | DEPARTMENT ENTRY
QUANTITY EXTENSION for DEPTs |

NOTE: The store coupon amount to be entered must not exceed the sale total unless the "Credit Balance" option is selected.

-- Receipt Print Format --

S. CPN	
CAN FOOD	-0.50TF

VENDOR COUPON

OPERATION

--- → ([ST]) → | Coupon Amount | [VND CPN] → ---

NOTE: The coupon amount to be entered must not exceed the sale total unless the "Credit Balance" option is selected.

-- Receipt Print Format --

V. CPN	-4.00TF
--------	---------

ITEM CORRECT

OPERATION

DEPARTMENT ENTRY
PLU ENTRY
REPEAT ENTRY
QUANTITY EXTENSION
SPLIT PACKAGE PRICING
RETURNED MERCHANDISE
BOTTLE RETURN of Inside-Sale Type
DOLLAR DISCOUNT
PERCENT CHARGE/DISCOUNT
STORE COUPON
VENDOR COUPON
RECEIVED-ON-ACCOUNT Item
PAID-OUT Item
MANUAL TAX

→ [ITEM CORR]

-- Receipt Print Format --

- CAN FOOD - - - - -	- \$1.00TF -
----------------------	--------------

NOTES:

1. When [ITEM CORR] is depressed after a Repeat Entry, only the last item of those repeated will be deleted.
2. When [ITEM CORR] is depressed after a Quantity Extension entry, the entire product (result of multiplication) will be deleted.

VOID

The VOID operation is used to delete an item already entered before the last item within the current sale. Such items cannot be deleted by the **[ITEM CORR]** key any longer.

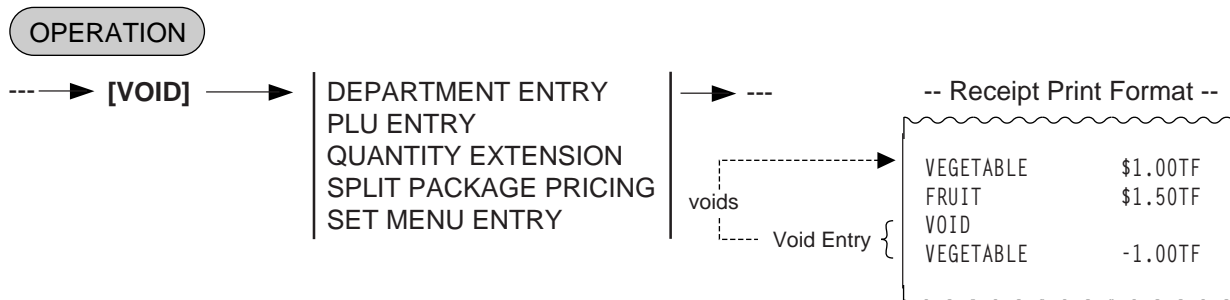

NOTE: An amount exceeding the sale total cannot be entered unless the "Credit Balance" option is selected.

ALL VOID

When the current transaction being entered is found to be canceled before finalizing it, ALL VOID can be operated to delete all the items entered in the transaction.

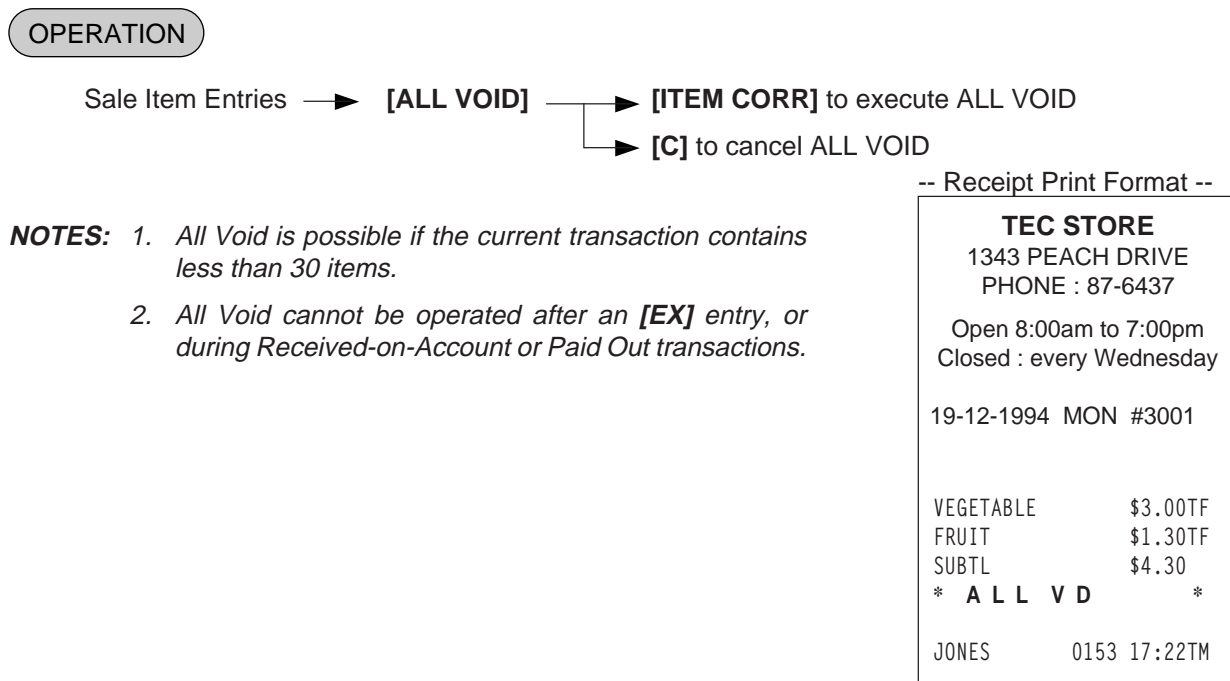

NON-ADD NUMBER PRINT

Non-add numbers can be entered and printed for future references, to indicate codes or numbers of customers, media checks, credit cards, etc. The entered numbers do not affect any sale total data.

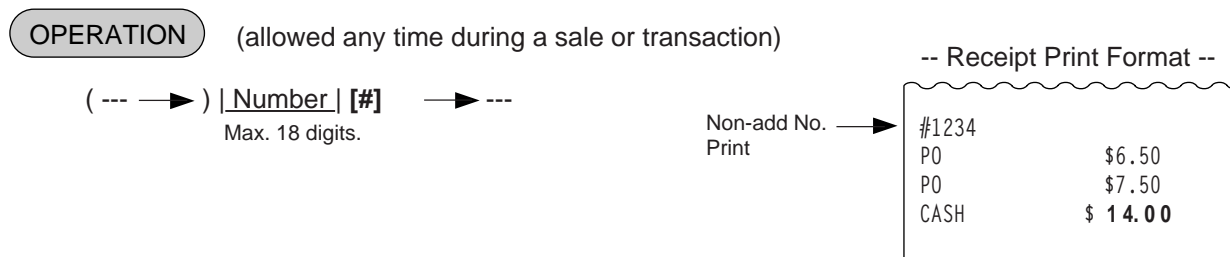

NUMBER-OF-GUESTS ENTRY

This operation is used to enter the number of guests of the sale.

OPERATION

(--- →) | Number of guests | **[GUEST No.]** → ---
Max. 3 digits

- NOTES:**
1. The Number-of-Guests entry is allowed at the start of or any time during a sale if before the sale finalization by media keys.
 2. When the operation is made more than once in a sale, the last entry is valid.
 3. The number entered is processed into the Tray Counter in the report memory.
 4. When the “No.-of-Guests Compulsory” option is selected, a sale cannot be finalized for payment until a number-of-guests entry is operated. However, the **[TOTAL]** key is operable even in this case.
 5. When a number-of-guests entry has not been made with the “No-of-Guests Not Compulsory” option, the count “1” is added to the Tray Counter in the report memory.

LISTING CAPACITY OPEN

For Department and PLUs

Depress **[LC OPEN]** (or **[OPEN]**) prior to or any time during an entry of an open-department, open-PLU, or preset-open department or PLU sequence (including REPEAT and QUANTITY EXTENSION entries). Please note that the **[LC OPEN]** or **[OPEN]** key must be pressed, at latest, before the final key of the entry sequence. The High Amount Limit for the department or PLU will be extended with two higher digits, and the Low Amount Limit will be extended with one lower digit. For entering an amount still exceeding these limits, you must call for a Manager Intervention.

For Media Tender Amounts

Depress **[LC OPEN]** (or **[OPEN]**) before or after the amount but Media Key. The High Amount Limit for the media tendering will be extended with one higher digit. In need of still exceeding this limit, you must call for a Manager Intervention.

For Amounts through **[DOLL DISC]**, **[VND CPN]**, **[STR CPN]**, **[BTL RTN]**

To exceed their limits, you must always call for a Manager Intervention. The **[LC OPEN]** or **[OPEN]** key will not be effective. As for the **[STR CPN]** key only, the amount is limited by both High Amount Limit of the department through which the store coupon amount is entered and the amount limit for **[STR CPN]**. That is, when an amount cannot be entered using **[LC OPEN]** or **[OPEN]**, you must call for a Manager Intervention.

SELECTIVE ITEMIZER (SI) STATUS MODIFICATION

Depress **[SI/M]** (or **[SI1/M]** and/or **[SI2/M]**) for entering the required Department or PLU item, the same way as **[LC OPEN]** is operated for Departments and PLUs. The SI-net status is reversed to non-net status, and vice versa.

TAX STATUS or FOOD STAMP STATUS MODIFICATION

Depress **[TX/M]** (or **[TX1/M]**, **[TX2/M]**, **[TX3/M]**, **[TX4/M]**, **[GST/M]**), in the same way as **[LC OPEN]** is operated, prior to or any time during the entry sequence of the required Department, PLU, or any other tax-status-programmable item (**[DOLL DISC]**, **[%-]**, **[%+]**, **[STR CPN]**, **[VND CPN]**, **[BTL RTN]**, **[EAT IN]**, **[TAKE OUT]**). The taxable status is reversed to non-taxable, and vice versa. The **[FS/M]** key operates the same to reverse from the Food Stampable status to non-stampable, and vice versa, of the required item.

MANUAL TAX ENTRY (where irregular tax amount addition is applied)

OPERATION

---→ | Irregular Tax Amount to be Added | [TAX] →---

-- Receipt Print Format --

TAX5	\$0.50
------	--------

SUBTOTAL (Sale Total Pre-taxed) READ

OPERATION

---→ [ST] →---

-- Receipt Print Format --

SUBTL	\$6.00
-------	--------

The sale total (pre-taxed) of the items so far entered is displayed (and printed if so programmed), but the sale is not finalized. Additional item entries are allowed, if any.

TAXABLE TOTAL (Sale Total With Taxes) READ

OPERATION

---→ [TXBL TL] →---

-- Receipt Print Format --

TXBL TL	\$9.20
---------	--------

The sale total including taxes due of the items so far entered is displayed (and printed if so programmed), but the sale is not finalized. Additional item entries are allowed, if any.

NOTE: Taxable total including a PB amount is displayed during Previous Balance entry.

TAXABLE TOTAL READ and SUBTOTAL PRINT

(when only one of [ST] and [TXBL TL] keys, not both, is installed on the keyboard)

In this case, the key is usually programmed as [ST] key with [TXBL TL] functions. Since this key has both [ST] and [TXBL TL] functions, it may be labeled as "[ST]" in some stores or as "[TXBL TL]" in others.

OPERATION

---→ [ST] →---
(or [TXBL TL])

The sale total including taxes of the items so far entered is displayed (and the sale total pre-taxed is printed if so programmed), but the sale is not finalized. Additional item entries are allowed, if any.

SELECTIVE ITEMIZER (SI) TOTAL READ

OPERATION

---> **[SI/TL]** → --- (for Single-SI Machine)
 ([SI1/TL] and/or [SI2/TL] for Dual-SI machine)

⋮
 The SI total is displayed and printed on the journal
 (and printed on receipt if so programmed.)

-- Journal Print Format --

SNACK	\$10.00TS
SI1 TL	-0.70
TAX	\$0.60
CASH	\$ 9.90

SI Total Calculated

NOTE: The fraction process method is fixed to Round OFF.

TAX CALCULATION AND PRINT

Your register has been programmed with proper tax tables (tax breaks and/or tax rates). Each department or PLU has been programmed with proper tax status, i.e. taxable or non-taxable status of each Tax (of maximum 4 taxes of Tax 1 to Tax 4, and GST).

On finalizing a sale, the taxes due are automatically calculated and printed on the receipt, and thus added to the sale.

Whether all taxes (Tax 1 to Tax 4, and GST) are consolidated into one line print or individually printed in separate lines is a program option.

-- Receipt Print Format --

Example of Consolidated Print Line

TAX	\$3.14
CASH	\$ 16.34

Example of Separate Print Lines

TAX1	\$2.48
TAX2	\$0.66
CASH	\$ 16.34

TAX EXEMPTION

OPERATION

Exemption from Selective Taxes

Examples)

- [TX1/M] [EX]** → Sale Finalization ... to exempt from Tax 1 only
- [GST/M]** → Sale Finalization ... to exempt from GST only
- [TX1/M] [TX2/M] [EX]** → Sale Finalization ... to exempt from Tax 1 & Tax 2
- [TX1/M] [TX2/M] [TX3/M] [EX]** → Sale Finalization ... to exempt from Tax 1, Tax 2, & Tax 3

Exemption from All Taxes

- [EX]** → Sale Finalization
 - [TX1/M] [TX2/M] [TX3/M] [TX4/M] [EX]** → Sale Finalization
- to exempt from all taxes.

NOTE: On depressing **[EX]**, the sale total including the exempted tax(es) is displayed and pre-taxed amount of the sale portion subject to the tax exemption is printed.

-- Receipt Print Format --

Pre-taxed amount of the sale portion subject to Tax1 Exemption	→	TAX1EX	\$9.90
Pre-taxed amount of the sale portion subject to Tax2 Exemption	→	TAX2EX	\$3.30

FOOD STAMPABLE TOTAL READ, FOOD STAMP TENDERING

OPERATION

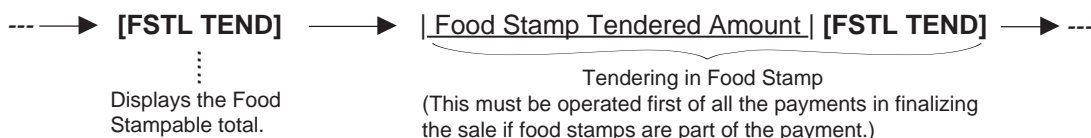

... When the Food Stamp tendered amount is less than the sale total, the sale is not finalized with the balance still due displayed. Then it can be finalized with cash or other media total or tendering operations.

-- Receipt Print Format --

Entire Sale Total	→	TOTAL	\$ 1 2 . 7 2
Food Stampable Total	→	FS/TL	\$12.72
Food Stamp Tendered Amount	→	F-STMP	\$15.00
Change in Cash	→	CHANGE	\$0.28
Change is Food Stamp	→	FS CHG	\$2.00

SALE FINALIZATION BY MEDIA KEYS

OPERATION

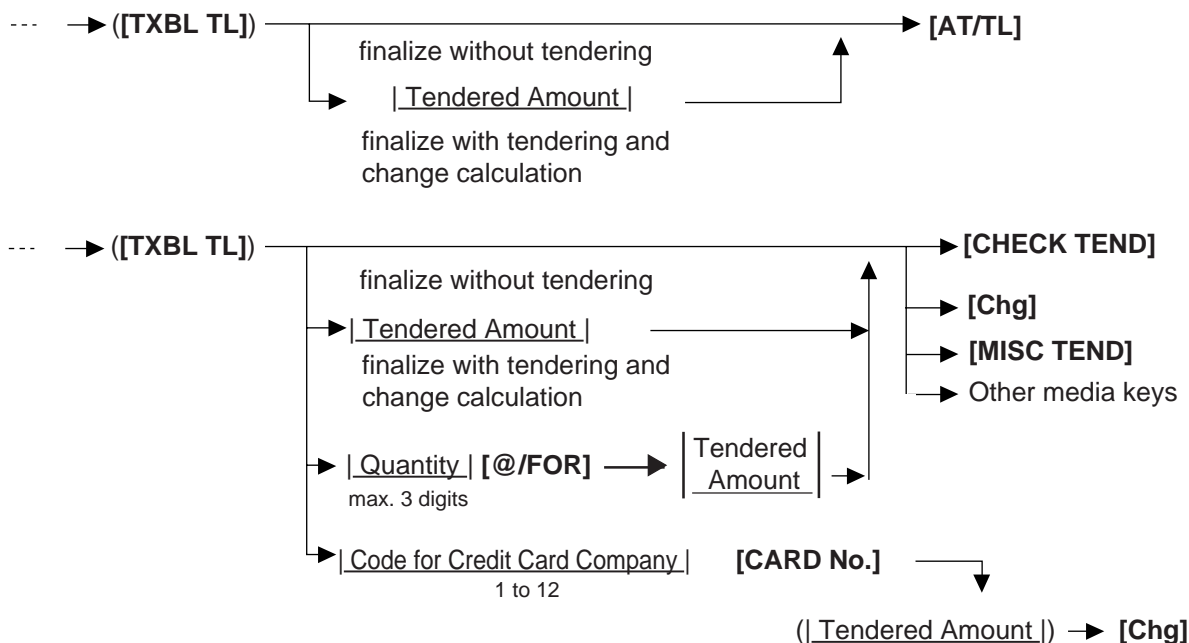

- NOTES:**
1. Whether each Media Key is depressed with a prior tendered amount entry or not is determined by the key status selections programmed for each media key.
 2. If the sale total is zero, any Media Key must be depressed without a tendered amount entry even if the key is programmed as "Tender" key.
 3. When a non-cash media key is programmed as "Tender-only" key, it cannot finalize a negative balance sale. Whether a "Total-only" or "Tender/Total" key can finalize a negative balance sale or not is a program option. Each of non-cash media key with Tender function may be programmed to prohibit Over-tendering and/or Short-tendering.

4. When a media is programmed to allow "Total" function, it can also be programmed with the "Drawer Open" or "Not Open" status on operating the key.

-- Receipt Print Format --

(Cash Total)		(Cash Tender)																									
<table style="width: 100%; border: none;"> <tr> <td>TAX</td> <td style="text-align: right;">\$0.48</td> <td></td> <td></td> </tr> <tr> <td>CASH</td> <td style="text-align: right;">\$ 8.4 8</td> <td></td> <td></td> </tr> </table>	TAX	\$0.48			CASH	\$ 8.4 8				<table style="width: 100%; border: none;"> <tr> <td>TAX</td> <td style="text-align: right;">\$0.48</td> <td></td> <td></td> </tr> <tr> <td>TOTAL</td> <td style="text-align: right;">\$ 8.4 8</td> <td></td> <td></td> </tr> <tr> <td>CATEND</td> <td style="text-align: right;">\$10.00</td> <td></td> <td></td> </tr> <tr> <td>CHANGE</td> <td style="text-align: right;">\$1.52</td> <td></td> <td></td> </tr> </table>	TAX	\$0.48			TOTAL	\$ 8.4 8			CATEND	\$10.00			CHANGE	\$1.52			
TAX	\$0.48																										
CASH	\$ 8.4 8																										
TAX	\$0.48																										
TOTAL	\$ 8.4 8																										
CATEND	\$10.00																										
CHANGE	\$1.52																										

MULTI-TENDERING

Short-tendering repeated multiple times by the same media (allowed only when the media key is programmed to allow short-tendering).

OPERATION

```

--- → ([TXBL TL]) → (|Quantity| [ @/FOR ]) → |1st Amount Tendered| [MEDIA]
                                |
                                |
                                → (|Quantity| [ @/FOR ]) → |2nd Amount Tendered| [MEDIA]
                                |
                                |
                                → Repeat if not yet finalized.
    
```

Multi-tendering by [AT/TL] key }
 Change due, as the result of the 2nd amount tendered —

-- Receipt Print Format --

<table style="width: 100%; border: none;"> <tr> <td>TAX</td> <td style="text-align: right;">\$0.48</td> <td></td> <td></td> </tr> <tr> <td>TOTAL</td> <td style="text-align: right;">\$ 8.4 8</td> <td></td> <td></td> </tr> <tr> <td>CATEND</td> <td style="text-align: right;">\$5.00</td> <td></td> <td></td> </tr> <tr> <td>CATEND</td> <td style="text-align: right;">\$5.00</td> <td></td> <td></td> </tr> <tr> <td>CHANGE</td> <td style="text-align: right;">\$1.52</td> <td></td> <td></td> </tr> </table>	TAX	\$0.48			TOTAL	\$ 8.4 8			CATEND	\$5.00			CATEND	\$5.00			CHANGE	\$1.52		
TAX	\$0.48																			
TOTAL	\$ 8.4 8																			
CATEND	\$5.00																			
CATEND	\$5.00																			
CHANGE	\$1.52																			

SPLIT TENDERING

Short-tendering repeated multiple times by the different media keys (allowed only when the media keys are programmed to allow short-tendering).

OPERATION

Example 1)

```

--- → ([TXBL TL]) → (|Quantity| [ @/FOR ]) → |Check Amount Tendered| [CHECK TEND]
                                |
                                |
                                → |Cash Amount Tendered| [AT/TL] ... Check & Cash
                                |
                                → |Company Code| [CARD No.] [Chg] ... Check and Credit Card
                                |
                                → |Cash Amount Tendered| [AT/TL] [Chg] ... Check, Cash, & Charge
    
```

Example 2)

```

--- → ([TXBL TL]) → |Cash Amount Tendered| [AT/TL]
                                |
                                |
                                → [Chg] ... Cash and Charge
    
```

- NOTES:**
1. In both **MULTI-TENDERING** and **SPLIT TENDERING** operations, the sale is finalized and a receipt is issued on reaching the sale total amount.
 2. If a media key is depressed without an amount tender entry and the key is programmed to function as "Total" key, the sale is then finalized on that stage processing the balance at that moment into that media.

-- Receipt Print Format --

TAX	\$0.48
TOTAL	\$ 8 . 4 8
CHECK	\$5.00
CASH	\$3.48

CHECK CASHING (No-sale cashing of a non-cash media)

OPERATION (must be operated outside a sale)

| Check Amount to be Cashed | **[CHECK TEND]**

... The drawer opens to enable the exchange.

NOTE: Other non-cash media keys may be used for this purpose if programmed to allow no-purchase cashing.

-- Receipt Print Format --

TEC STORE	
1343 PEACH DRIVE	
PHONE : 87-6437	
Open 8:00am to 7:00pm	
Closed : every Wednesday	
19-12-1994 MON #3001	
CHECK	\$ 1 0 . 0 0
JONES	0189 17:44TM

Check Amount Cashed →

SALE PAID IN FOREIGN CURRENCIES

OPERATION

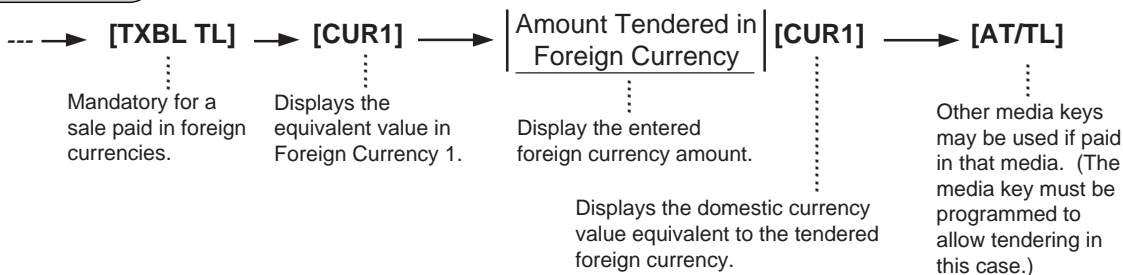

- NOTES:**
1. The **[CUR 2]** to **[CUR 5]** keys operate the same as **[CUR 1]**, except that each of these keys has its own exchange rate programmed corresponding to each foreign currency.
 2. The amount tendered in the foreign currency and its exchange rate may be programmed to print by program options.
 3. Multi-tendering with the same foreign currency or Split-tendering with other medias or foreign currencies are possible.
 4. The foreign currency keys cannot be used to finalize Received-on-Account payments, Paid-out items, or Previous Balance Entry.

5. When a tendering by a foreign currency occurs during a short-tendered condition, the **[TXBL TL]** key will not be mandatory.
6. A sale of negative balance cannot be finalized using any of the foreign currency keys.

-- Receipt Print Format --

	TAX	\$0.48
	TOTAL	\$ 8 . 4 8
	CUR1	50.00
Optional Print {	Amount Tendered in CUR1	
	CUR1 Exchange Rate	5.3729*
Domestic Currency Value equivalent to the tendered foreign currency amount	CATEND	\$9.31
Change due (to be refunded in Domestic Currency)	CHANGE	\$0.83

NO-SALE EXCHANGE from Foreign Currency to Domestic Currency

OPERATION (must be operated outside a sale)

[CUR 1] → | Amount of Foreign Currency 1 to be exchanged | **[NS]**

... The drawer opens to enable exchange. Displays the domestic currency amount equivalent to the entered foreign currency amount.

- NOTES:**
1. The **[CUR 2]** to **[CUR 5]** keys operate the same.
 2. The fraction process method is fixed to Round OFF.

-- Receipt Print Format --

	CUR2	10.00
		1.7619*
Amount of CUR2 to be exchanged	CHANGE	\$5.68
Exchange Rate (optional print)		
Domestic Currency amount equivalent to the CUR2	JONES	0197 18:02TM

NO-SALE EXCHANGE from Domestic Currency to Foreign Currency

OPERATION (must be operated outside a sale)

| Amount of Domestic Currency to be exchanged | **[CUR 1]** → **[NS]**

... The drawer opens to enable exchange. The display content of the CUR 1 value obtained on the **[CUR 1]** key depression is held.

- NOTES:**
1. The **[CUR 2]** to **[CUR 5]** keys operate the same.
 2. This operation (exchange from domestic to foreign currencies) may be prohibited by a program option.
 3. The fraction process method is ruled by "Foreign Currency Rounding Process Setting".

-- Receipt Print Format --

	CATEND	\$1.00
		1.445*
Domestic Currency amount to be exchanged	CUR3	1.45
Exchange Rate of CUR3 (optional print)		
CUR3 amount equivalent to the domestic currency amount	JONES	0198 18:03TM

RECEIVED-ON-ACCOUNT

A received-on-account transaction is used to identify money which is in the drawer but not from the daily business.

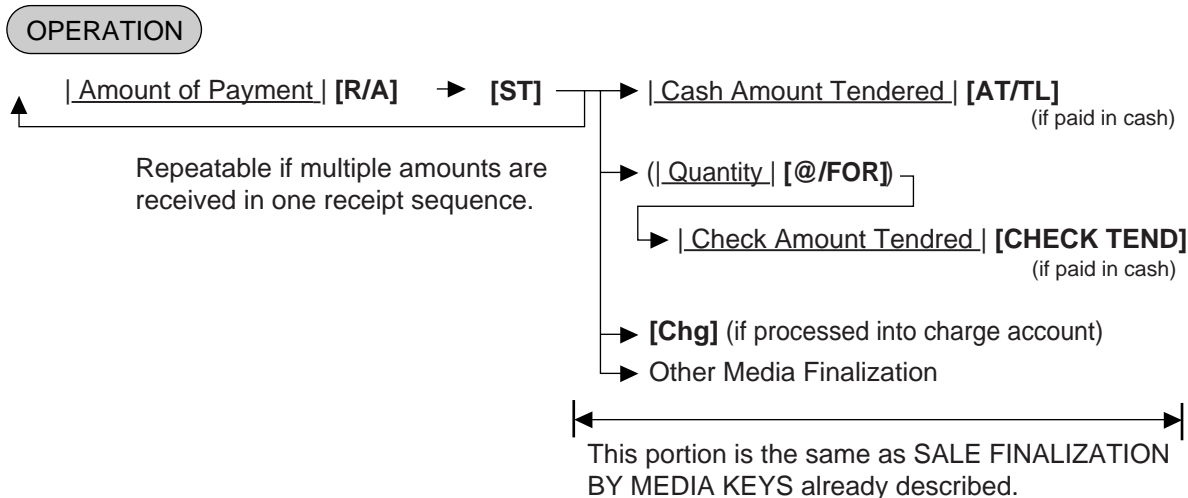

- NOTES:**
1. The media keys used for this operation must be programmed to allow received-on-account entries.
 2. MULTI-TENDERING and SPLIT-TENDERING (already described) are also applied to the finalization of received-on-account payments.

-- Receipt Print Format --

R/A	\$5.00
R/A	\$3.00
SUBTL	\$8.00
CASH	\$ 8.00
JONES	0199 18:04TM

PAID-OUT

A paid-out transaction is used when money is removed from the drawer without totaling to a sale.

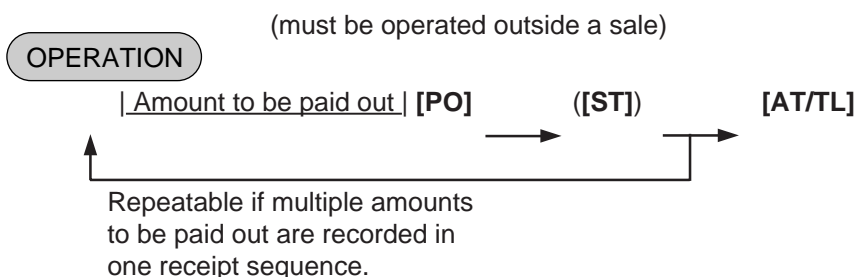

NOTE: Only [AT/TL] can finalize paid-out amount (i.e. must always be paid out in cash).

-- Receipt Print Format --

PO	\$4.50
PO	\$3.20
SUBTL	\$7.70
CASH	\$ 7.70
JONES	0202 18:05TM

SALESPERSON ENTRY (Salesperson Sign-ON)

OPERATION

| Salesperson Code | [SALES PERSON] → --- ... The name of the person is displayed and printed on both journal and receipt.
1 to 99

Programmable options relating to Salesperson Entries:

- Salesperson's name non-print on receipt (print on journal only)
- Salesperson Entry compulsory before sale item entries
- Salesperson Entry Prohibited during a sale (i.e. allowed only one person entry at the starting of a sale but prohibits any other salesperson entry once the sale is started.) When this program is not selected, up to five salespersons can sign ON during one sale.

The salesperson entry status (salesperson Signed-ON condition) will be held until:

- Another salesperson entry is operated, or
- The sale is finalized.

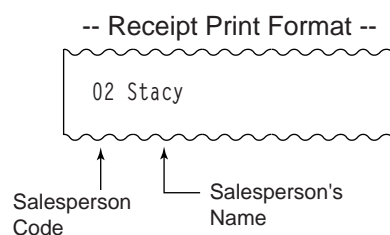

FUNCTION KEY ENTRY

This operation will execute a string of key operations preprogrammed on each [FUNCTION] key.

OPERATION

--- → [FUNCTION] (→ ---)

⋮

[FUNCTION 1] to [FUNCTION 10]

- The following key operations are pre-programmed on the [FUNCTION 5] key in this example.

[1] [00] [DP1] [ST] [AT/TL]

NOTE: The following key operations are preprogrammed to the [FUNCTION 1] to [FUNCTION 4] keys as initial setting.

- [FUNCTION 1] — [1] [00] [AT/TL]
- [FUNCTION 2] — [5] [00] [AT/TL]
- [FUNCTION 3] — [1] [0] [00] [AT/TL]
- [FUNCTION 4] — [2] [0] [00] [AT/TL]

-- Receipt Print Format --

TEC STORE
1343 PEACH DRIVE
PHONE : 87-6437

Open 8:00am to 7:00pm
Closed : every Wednesday

19-12-1994 MON #3001

VEGETABLE	\$1.00TF
SUBTL	\$1.00
TAX	\$0.21
CASH	\$ 1.06

ITEM 1
JONES 0207 18:07TM

TIP PAID

OPERATION

| Cashier Code | **[TIP PAID]** → | Tip Amount | → **[AT/TL]**
 Max. 7 digits

-- Receipt Print Format --

TIP PAID JONES	
CASH	\$1.00
SMITH 0028 14:09TM	

CHARGE TIP

OPERATION

Order Entry (or Additional Order Entry)
 → | Tip Amount | **[CHARGE TIP]** → Payment Entry using the media as the tip.
 Max. 7 digits

NOTE: The **[AT/TL]** key cannot be used as the first tendering after a Charge Tip Entry.

-- Receipt Print Format --

P B +	\$0.00
Frd Chicken	\$4.50T
Veget. Salad	\$2.20T
Corn Soup	\$2.50T
Beer	\$1.40T
CHG TIP	\$1.00
TAX1	\$0.64
TAX2	\$0.07
TOTAL	\$1 2.3 1
CHECK	\$20.00
CHANGE	\$7.69
TEM 4	
SMITH	0030 14:17TM

RECEIPT POST-ISSUE

OPERATION (must be operated outside a sale)

(A sale is finalized) —→ **[RECEIPT ISSUE]**

Programmable options:

- Post-issue receipt is available only when the sale has been finalized with the sale has been finalized in Receipt-OFF mode.
 - Available regardless of Receipt-ON/OFF mode (in this case two receipts may be obtained for one sale.)
-
- Post-issue receipt is itemized receipt for a sale of maximum 50 lines. Exceeding 50 lines, the post-issue receipt is total-only receipt.
 - Post-issue receipt is always total-only receipt regardless of the number of lines of a sale.
-
- Post-issue receipt is issued only once.
 - Post-issue receipt can be issued any number of times.

- NOTES:**
1. *The post-issue receipt content will not be printed on the Guest Check Printer.*
 2. *The post-issue receipt is not available for Received-on-Account or Paid-Out transactions.*

-- Post-issue Receipt --

-- Ordinary Receipt --

19-12-1994 MON #3001	
VEGETABLE	\$1.00TF
Cheese	\$2.50TF
%-	
5%	-0.13T
TAX	\$0.06
TOTAL	\$ 3.5 8
CATEND	\$5.00
CHANGE	\$1.42
ITEM	2
JONES	0213 18:14TM

Itemized Type

19-12-1994 MON #3001	
* COPY *	
VEGETABLE	\$1.00TF
Cheese	\$2.50TF
%-	
5%	-0.13T
TAX	\$0.06
TOTAL	\$ 3.5 8
CATEND	\$5.00
CHANGE	\$1.42
ITEM	2
JONES	0213 18:14TM

Total-only Type

19-12-1994 MON #3001	
* COPY *	
TOTAL	\$ 3.5 8
JONES	0213 18:20TM

This line is printed only when a post-issue receipt is issued after the Ordinary Receipt is issued, or the second and subsequent post-issue receipts are issued.

TRAY TOTAL

OPERATION

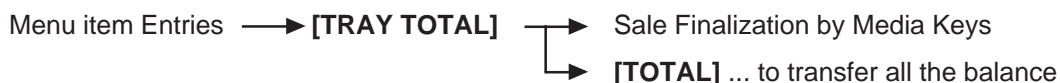

-- Receipt Print Format --

P B +	\$0.00
Pork Saute	\$4.50T
ITEM 1	
TRAY TL	\$4.50

Fried Shrimp	\$6.50T
Coke Small-B	\$0.70T
TAX1	\$0.43
TAX2	\$0.03
ITEM 2	
TRAY TL	\$7.66

TAX1	\$0.70
TAX2	\$0.03
CASH	\$1 2.4 3
ITEM 3	
SMITH	0031 14:24TM

← 1st Tray Total Separator Line

← 2nd Tray Total Separator Line

Entire Sale Data

EAT-IN/TAKEOUT ENTRY

OPERATION

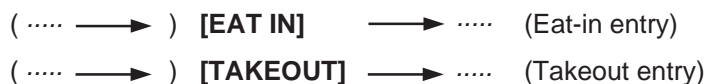

- NOTES:**
1. Depressing the [EAT IN] or [TAKEOUT] key is allowed any number of times during one sale. The last key entered is effective.
 2. Program option allows you to select either Eat-in entry or Takeout entry as standard. In this case, Eat-in or Takeout entry is available without depressing the respective keys.
 3. Eat-in or Takeout entry is unavailable after tax exemption.

Eat-in Symbol



Takeout Symbol



CALL NO. ENTRY

This operation is used to enter the call No. of order, and to print its No. on the receipt and the journal.

OPERATION

(..... →) | CALL NO. | [CALL No.] →

Max. 3 digits

- NOTES:**
1. Call No. entry is allowed any time during a sale.
 2. Call No. entry is allowed any number of times during one sale.
 - On receipt and journal, all the Call Nos. entered during one sale are printed.
 3. Compulsion of Call No. entry can be programmed by the program option. In this case, the sale finalization is not allowed unless entering the Call No.
 4. Automatic creation of Call No. can be programmed by the program option. In this case, the Call No. is automatically created when a department/PLU item is entered.
 5. Call No. entry is unavailable when the drive-through option is selected.

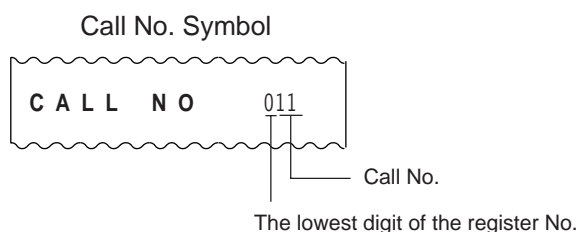

DRIVE-THROUGH ENTRY

This operation is available only when the drive-through spec. is selected in the program option.

OPERATION

Same as

DEPARTMENT ENTRY
PLU ENTRY
SET MENU ENTRY

- NOTES:**
1. Order No. is automatically created when a department/PLU item is entered.
 - Number of order tables ——— Max.20
 - Order No. ————— 01 to 20
 2. Entry of a department/PLU item causes an error while all the order tables have been used.

RECALL ENTRY

This operation recalls a order table.

OPERATION

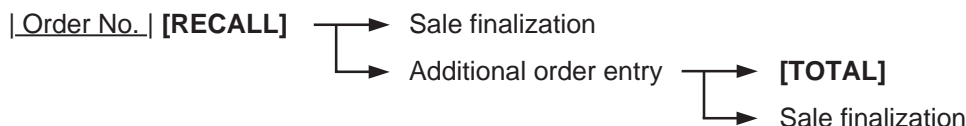

NOTE: Recall Entry can be canceled.
To end the entry, follow the procedure described below.

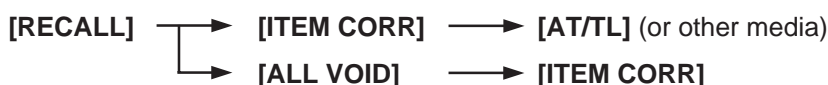

VALIDATION PRINT

OPERATION

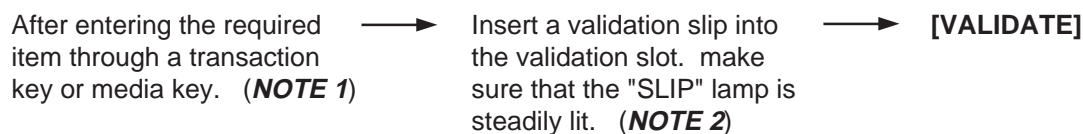

NOTES: 1. If the "SLIP" lamp flickers during registrations, it indicates that the last item just entered is programmed to require validation print. In this case, no other operations can follow until the validation print of the item is first executed.

2. Because printing occurs on the front side of the slip, please be certain to insert the slip into the validation with the printing side forward.

3. No other operations can follow until the validation slip once printed is withdrawn.

4. The following are programmable selections relating to validation:

(1) PRINT FORMAT

- a) Date Print/Non-print
- b) Consecutive No. Print/Non-print
- c) Cashier No. Print/Non-print

(2) MULTI- or SINGLE-VALIDATION (Number of times of validation print allowed for the same item)

(3) VALIDATION COMPULSORY status on Media Keys and other transaction keys.

5. When the sale-finalizing media key is programmed with Validation Compulsory status and the key is used with over-tendering, the drawer will open on the compulsory validation print.

6. When the sale-finalizing media key is programmed with Validation Compulsory status and the key is used with equal-tendering or used as Total key, the drawer will open even if the status "Not Open" is programmed on the key.

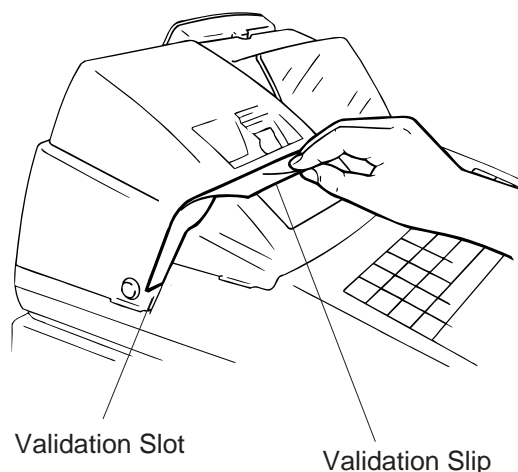

-- Receipt Print Format --

TEC STORE
 1343 PEACH DRIVE
 PHONE : 87-6437
 Open 8:00am to 7:00pm
 Closed : every Wednesday
 19-12-1994 MON #3001
 Cheese \$2.50TF
 RTN -1.20TF
 VEGETABLE -1.20TF
 TXBL TL \$1.38
 #123456
 TAX \$0.08
 ABC \$1.38
 ITEM 0
 JONES 0221 13:35TM

fi	12-19-94	01CL0146	Cheese	\$2.50TF
fi	12-19-94	01CL0146	RTN VEGETABLE	-1.20TF
fi	12-19-94	01CL0146	TXBLTL	\$1.38
fi	12-19-94	01CL0146	#123456	
fi	12-19-94	01CL0146	ABC	\$1.38

Date Cashier ID (Manager-assign portion code) Receipt Consecutive No. Item Name Amount

When the option "Total Validation" (Prints SALE TOTAL after [TXBL TL]) is selected, the sale total will be printed (instead of Taxable Total) on the validation slip on a [VALIDATE] key depression after the [TXBL TL] key is operated. In this case, only the finalization of the sale can follow.

ENDORSEMENT PRINT

OPERATION

After operating the required non-cash media key (usually the [CHECK TEND] key)

Insert the check or the required slip into the Guest Check Printer (or into the Validation Slot of the Receipt/Journal Printer with multi-validation function.)

Enter the Check No. (if so programmed), and then depress [CHECK NO.] key.

- NOTES:**
1. Endorsement Message can be printed on the Receipt/Journal Printer with Multi-validation Function.
 2. The Check No. entry prior to the [CHECK NO.] key may be programmed to be compulsory.

-- Endorsement Print Sample --

19-12-1994 MON #3001
 VEGETABLE -1.20TF
 FRUIT \$6.50TF
 MEAT \$6.00TF
 TAX \$0.68
 TOTAL \$11.98
 CHECK \$15.00
 CHANGE \$3.02
 ITEM 1
 JONES 0222 14:35TM

Printed on Guest Check Printer:

CHECK 324628
TEC STORE
 1343 PEACH DRIVE, TORRANCE,
 CALIFORNIA
 TOTAL \$11.98
 #3001 CHECK \$15.00
 1CL 0222 19-12-1994 14:35TM

Check No. Line
 Endorsement Message Lines
 Total Line (may not be printed)
 Check Amount Line
 Cashier ID, Consecutive. No.,
 Date, Time

Printed on Receipt/Journal Printer:

TEC STORE
 1343 PEACH DRIVE, TORRANCE,
 CALIFORNIA
 TOTAL \$11.98
 #3001 CHECK \$15.00
 1CL 0222 19-12-1994 14:35TM

GUEST CHECK PRINTER (hardware option) OPERATION

The TEC Guest Check Printer DRS-207 may be connected to the FS-1450 series ECR as an optional device. The Guest Check Printer will operate printing if a slip is properly inserted, regardless of the Mode Lock position (except that no print will occur in the "SET" mode or during program verification in the "X" mode).

1. The guest check printer will automatically activate printing when the slip has properly been set to the printer table.
2. The following are selective status programmable relating to the guest check printer. Ask the store manager and mark the status selected for your store.

SYSTEM OPTIONS RELATING TO GUEST CHECK CONTROL

- Guest Check Print compulsory for Previous Balance entry:
Standard: COMPULSORY
Option: FREE (Not compulsory)
 - Code No. (Check No.) Entry Before [**CHECK NO.**] key at Endorsement Print (Refer to ENDORSEMENT PRINT operation already stated.)
Standard: FREE (Not compulsory)
Option: COMPULSORY
 - Date on the guest check
Standard: PRINT
Option: NON-PRINT
3. The gap of the slip inlet is usually opened, and the slip may be inserted or withdrawn freely outside a receipt/journal print sequence.
When a slip is properly set to the guest check printer and the ECR is operated, the gap will be closed and printing will be performed. When the sale is finalized and the receipt is issued, the gap of the DRS-207 will be opened to allow the slip withdrawal. (The gap keeps closed during sale item entries.)
 4. The EJECT key on the DRS-207 may be used to open the closed gap in order to withdraw the slip and skip unnecessary item print. The EJECT key will be disregarded if the slip is set and the ECR receipt/journal printer is in a printing action.
 5. Printing on the guest check will be performed alternately with printing on the receipt/journal of the ECR.
 6. When printing of a check requires more than one page, operate as in the following for multi-page process:
 - 1) When printing reaches the last line (limit line) of the first page, printing stops, and the AMOUNT portion of the display flickers.
 - 2) Withdraw the first page, and insert the second page.
Then depress the [**C**] key on the ECR Keyboard. Printing resumes.
 7. To make an additional order(s) when an entry(ies) has already been made on the check slip, use the [**GCP LINE #**] key. For its entry procedure and receipt sample, refer to ADDITIONAL ORDER ENTRY already stated.

WHEN A POWER FAILURE OCCURS ...

If a power failure occurs, all sales data stored in the memory are automatically protected by the battery installed in the ECR. The battery is rechargeable and it is recharged when the AC power returns. As the power returns, the register revives to continue the work and displays the last item entered before the power failure. However, please note the following phenomena to occur on the register when the power is regained:

1. The printer will work to print the entered data without failure after the power recovery, if any data was being printed. However, one extra line may be fed on the power recovery depending on the power-recovery timing.

Example:

RTN	
VEGETABLE	-1.45TF
RTN	
Soup Can	-0.45TF

One extra line is fed here, i.e., a power failure occurred during printing the returned item of "VEGETABLE \$1.45".

2. The following are the display indications on the power recovery:

ECR CONDITION at the time of Power Failure		DISPLAY INDICATION on the Power Recovery
OUTSIDE A SALE	No key-in has been operated.	Displays zero. Operations may go on.
	Numeric or Declaration keys have been entered but not motorized keys.	Regains the display content that was obtained just before the power failure. The operations may be continued.
DURING A SALE	No Numeric or Declaration keys have been entered.	Regains the display content that was obtained just before the power failure. The operations may be continued.
	Numeric or Declaration keys have been entered.	

In the event of a power failure, it is suggested to check the receipt print content before the receipt is handed to the customer.

11. JOURNAL AND RECEIPT PAPER-END DETECTOR

- (1) This detects when either the journal or receipt paper is coming near the end. It is provided in order to prompt the operator to replace the old paper roll with a new one.
- (2) When the paper roll comes near the end (or the paper has not been set properly), no key operation will be accepted and the AMOUNT portion of the display will keep flickering.
- (3) When a new paper roll is set, only the **[RF]** and **[JF]** keys are allowed to operate. Next, when the **[C]** key is depressed, the display flickering will be cleared and normal key-in operations will be accepted. If any printing was suspended, it will continue printing.
- (4) If this detector senses a paper-end condition during printing, the printing will stop after the current line printing is completed.
- (5) If the **[C]** key is depressed in the paper-end condition, it will be ignored. The **[C]** key depression will be effective to clear the display flickering only after the new paper roll is set.

(For further details, refer to Chapter 15.)

12. ECR PRINTER MOTOR LOCK DETECTOR

- (1) This detects the printer motor lock condition caused by some trouble.
- (2) When such a condition is detected, the front display indicates "Error" and none of the keys (including **[RF]** and **[JF]**) will be accepted.
- (3) To regain the normal condition, turn the power of the ECR to OFF, remove the cause of the motor lock, and then turn the power to ON again.

13. GUEST CHECK PRINTER MOTOR LOCK DETECTOR

- (1) This detects the guest check printer motor lock condition caused by some trouble.
- (2) When such a condition is detected, the front display indicates "Error" and none of the keys (including **[RF]** and **[JF]**) will be accepted.
- (3) To regain the normal condition, turn the powers of the ECR and the guest check printer to OFF, remove the cause of the motor lock, and then turn the powers to ON again.

* If the cause cannot be found in the guest check printer and only the ECR may be required to work temporarily without the guest check printer, remove the guest check printer cable from the ECR, and turn the power of the ECR to ON.

14. PRINTER GUIDE OPEN DETECTOR

- (1) This detects the printer guide open condition.
- (2) When such a condition is detected, the front display indicates "Error" and none of the keys (including **[RF]** and **[JF]**) will be accepted.
- (3) To regain the normal condition, turn the power of the ECR to OFF, close the printer guide, and then turn the power to ON again.

15. PAPER ROLL REPLACEMENT AND OTHER MAINTENANCE OPERATIONS

WARNING!

Care must be taken not to injure yourself with the paper cutter.

Replacing the Receipt Roll

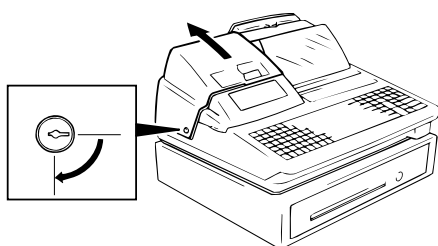

1

To remove the Receipt Cover, insert the Receipt Cover Key to the Receipt Cover Lock, and turn it 90° clockwise.

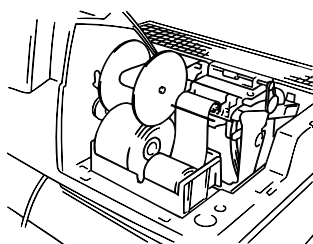

2

Cut the Receipt Paper as shown in the figure.

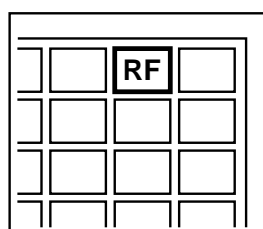

3

Depress the **[RF]** key to feed the remaining paper end.

CAUTION: *Never try to pull out the remaining paper end by hand. It may cause paper jamming.*

4

Load new paper roll as described in Chapter 6.

Replacing the Journal Roll

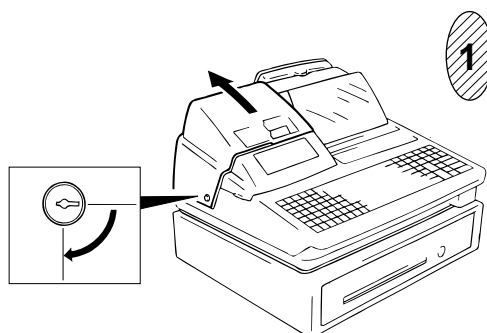

- 1** To remove the Receipt Cover, insert the Receipt Cover Key to the Receipt Cover Lock, and turn it 90° clockwise.

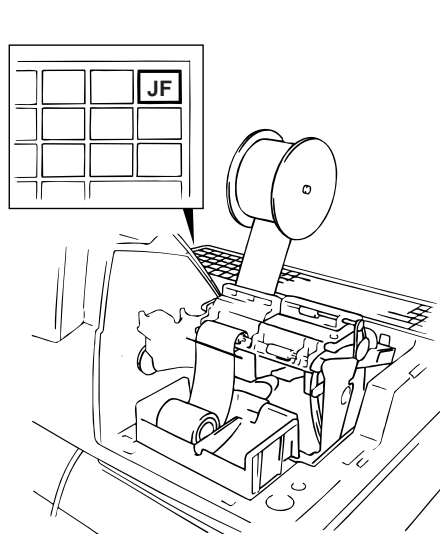

- 2** Depress the **[JF]** key to wind up enough of the Journal Paper, then cut the paper as shown in the figure. Depress the **[JF]** key to feed the remaining paper end.

CAUTION: *Never try to pull out the remaining paper end by hand.
It may cause paper jamming.*

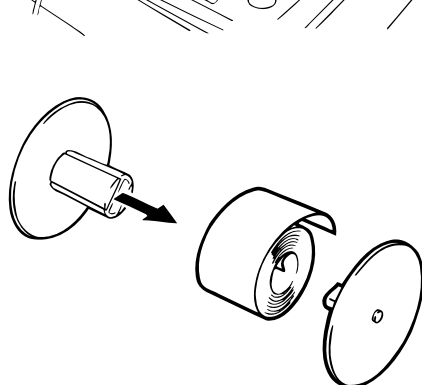

- 3** The wound-up portion of the paper can be easily removed from the Reel by pulling it sideways.

- 4** Load new paper roll as described in Chapter 6.

Replacing the Ribbon Cassette

When the print data on the receipt and journal becomes too dim, replace the Ribbon Cassette in the following order.

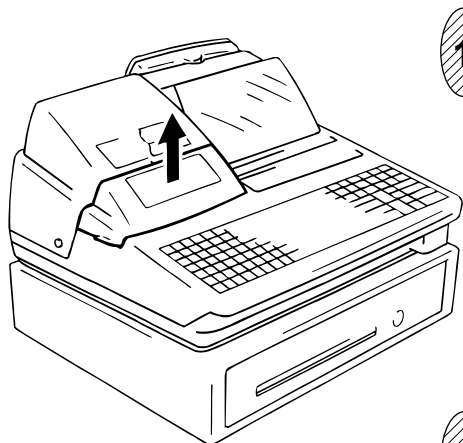

1

Remove the Ribbon Cover.

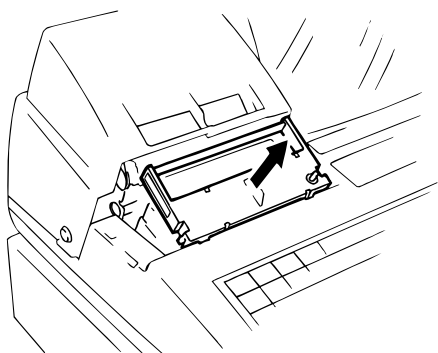

2

Remove the old ribbon cassette by pulling it in the direction of the arrow mark.

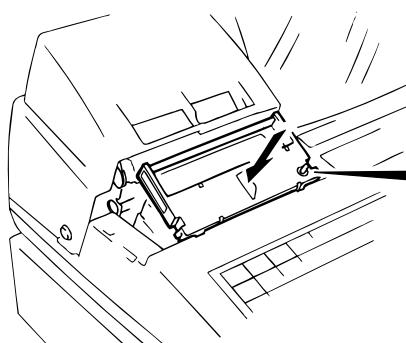

3

Install a new ribbon cassette by inserting it in the direction of the arrow mark.
Then, turn the knob of ribbon cassette several times in the arrow direction to take up the slack in the ribbon.



4

Attach the Ribbon Cover.

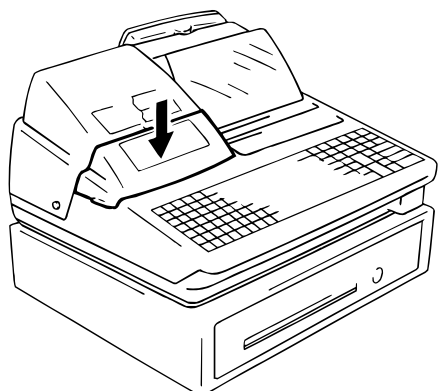

Replenishing Ink to the Store Name Stamp

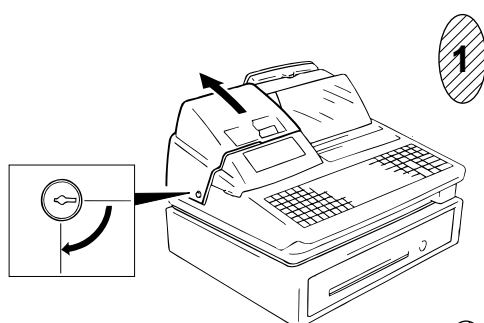

1

To remove the Receipt Cover, insert the Receipt Cover Key to the Receipt Cover Lock, and turn it 90° clockwise.

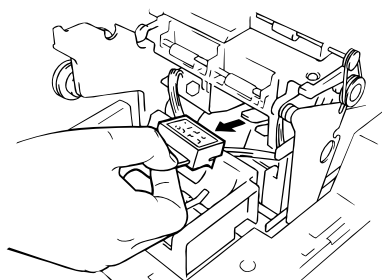

2

Remove the Store Name Stamp by pulling it in the direction of the arrow mark.



3

Apply only two or three drops. Stamp may not print dark immediately. Allow time for ink to saturate the stamp.

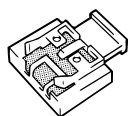

4

Install the stamp by inserting it in the direction of the arrow mark.

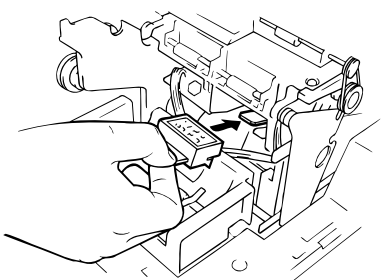

5

Attach the Receipt Cover.

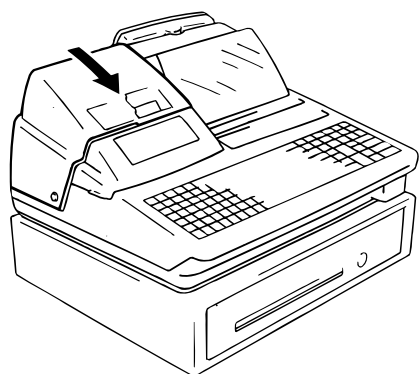

Manual Drawer Releasing

The drawer opens automatically when a transaction has been entered. In the event of a power failure or other trouble, the drawer can be opened manually in the following manner:

WARNING!

When opening the cash drawer, be careful not to let the drawer hit any person.

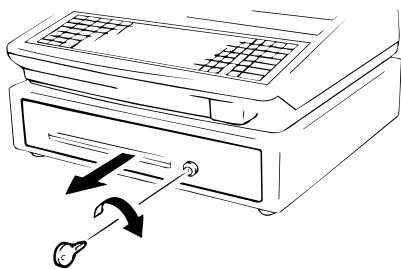

Fig. 1

1

Insert the Drawer Release Key into the drawer release lock and turn the key clockwise. The drawer will then open. (Fig. 1)

2

The Drawer Release Key can be taken out by returning it to the original position.

3

When the drawer is closed, it is automatically locked and will not open without the Drawer Release Key or a normal registering operation.

Removing the Drawer

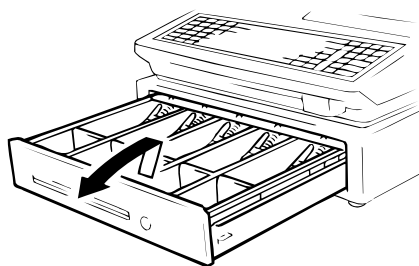

Fig. 2

1

Pull the drawer out, and when it stops at the stopper, lift the drawer up and pull it further out (Fig. 2). When it stops again at the roller fixed in the drawer housing, lift it and pull it out (Fig. 3)

2

To return the drawer, follow the reverse procedure for removing.

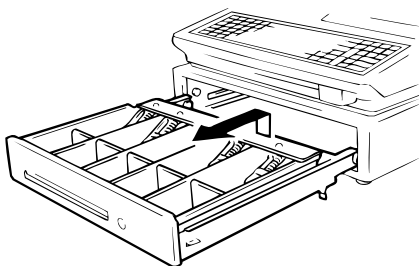

Fig. 3

CDC (Cash Drawer Cover; Option) Lock

Locking (Fig.4)

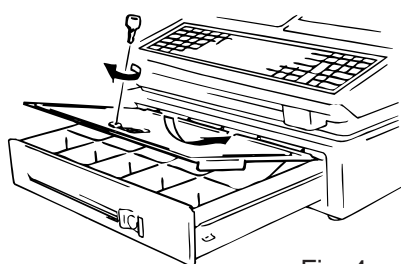

Fig. 4

1

Push the Cash Drawer Cover to the back of the drawer.

2

Press the cover lightly, insert the key into the key hole on the cover, and turn it to lock.

Unlocking

Unlock the cover using the key, and lift the front end.

16. SPECIFICATIONS

Size	460 mm (width) x 450 mm (depth) x 318 mm (height) (height including rubber feet) (or 391 mm-height when Customer Display is popped up.)
Weight	15.5 kg
Power Required	AC 117 V – 10%; 60 Hz – 10% (varies depending on the destination)
Power Consumed	0.6 A at 117 V
Ambient Temperature	0 C to 35 C
Relative Humidity	10% to 90% RH
Size of Receipt and Journal Tape	45 mm (width) x Max. 80 mm (diameter)

MANAGER'S GUIDE

TABLE OF CONTENTS

	Page
1. DAILY OPERATION FLOW	1
2. MANAGER INTERVENTION	2
3. MANAGER'S OWN OPERATIONS IN "MGR" MODE	5
4. OPERATIONS IN "☐" MODE	7
5. READ (X) AND RESET (Z) REPORT	9
6. PROGRAMMING OPERATIONS	26
7. VERIFICATION OF PROGRAMMED DATA	67

1. DAILY OPERATION FLOW

The following shows the typical flow of daily operations on the ECR.

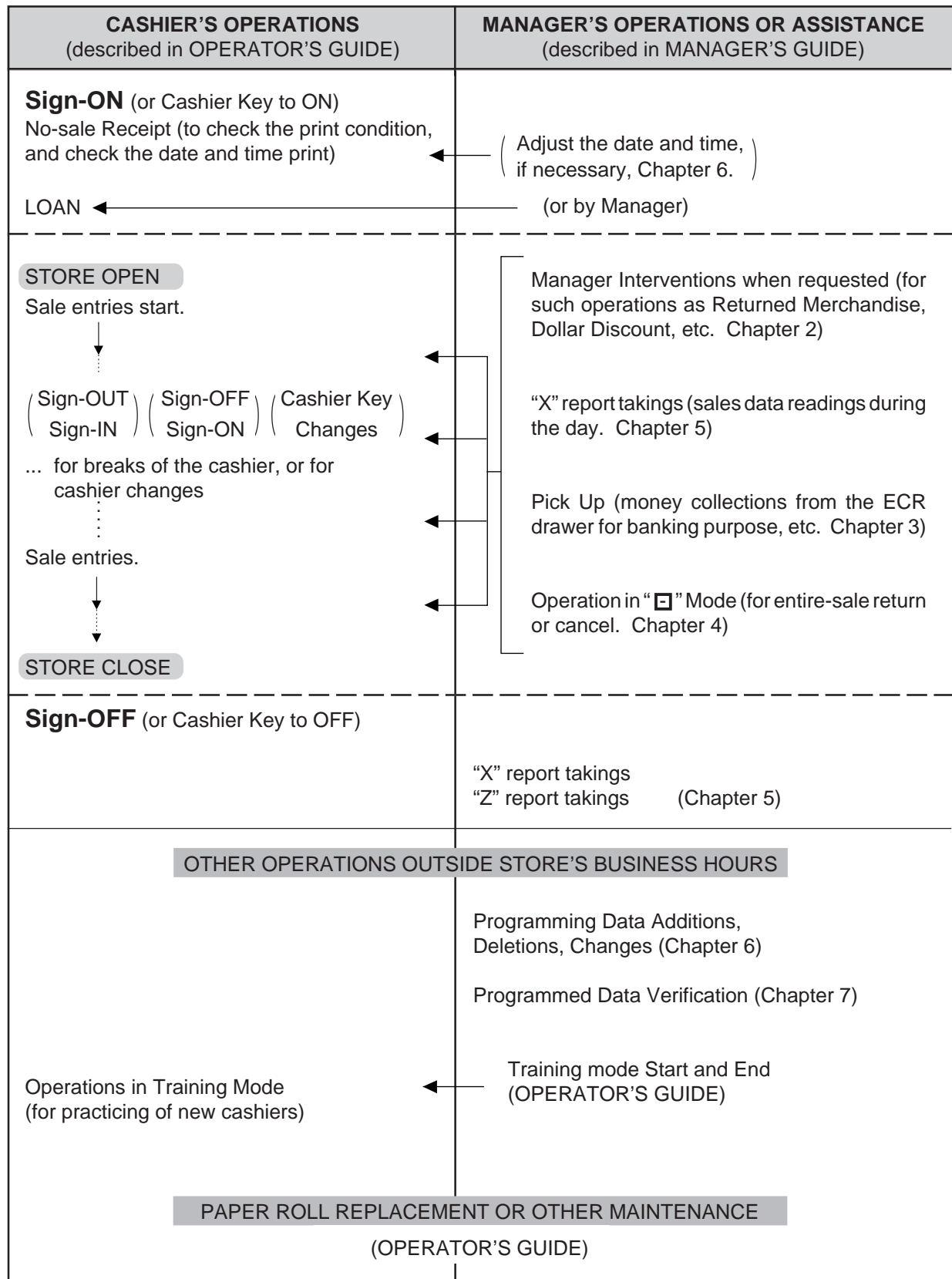

2. MANAGER INTERVENTION

2.1 ITEMS PROGRAMMED TO REQUIRE MANAGER INTERVENTIONS

During daily sale entry operations, the cashier may call for Manager Interventions. The following is the operation flow of a Manager Intervention.

- 1) During operations, the cashier comes across an item that requires a Manager Intervention. The cashier, already informed of it, may immediately call for a Manager Intervention. Or the cashier, without knowing of it, attempts the operation, and error results, clears the error by the **[C]** key, and then calls for a Manager Intervention.
↓
- 2) The manager goes to the cashier counter with the **MGR** or **MA** key.
↓
- 3) The cashier explains what kind of operation is attempted, and removes the **REG** key from the Mode Lock at the "**REG**" position.
↓
- 4) The manager inserts the **MGR** or **MA** key and turns it to the "**MGR**" position.
↓
- 5) The cashier operates the required item.
↓
- 6) The manager returns the **MGR** or key to the "**REG**" position and pulls it out.
↓
- 7) The cashier sets the **REG** key to the "**REG**" position again and continues registering operations.

The following are the tables of the keys and operations that are programmable with Manager Intervention. Fill in the table by marking in the "Not Required" or "Required" column of each item, referring to the documents, etc. listed in the table.

KEYS/OPERATIONS AND MANAGER INTERVENTION STATUS TABLE

KEY	Manager Intervention		Reference
	Not required	Required	
[DOLL DISC]			Chapter 7: VERIFICATION OF PROGRAMMED DATA • KEY STATUS READ As for changing the key status, ask your TOSHIBA TEC representative.
[VND CPN]			
[STR CPN]			
[BTL RTN]			
[%] (or [% II])			
[RTN MDSE]			
[VOID]			
[PO]			
[TIP PAID]			
[CHG TIP]			
[MENU SHIFT] (1 to 3)			
[EX]			
[NS]			
[ALL VOID]			
Credit Balance (NOTE 1 below)			These are program options for each store. Ask your TOSHIBA TEC representative for information and these status changes.
Negative-balance Sale Finalization by Media Keys except [AT/TL] and [FSTL TEND] (NOTE 2)			
Negative Department or negative PLU Entries (NOTE 3)			

- NOTES:**
- The "Credit Balance" means that amount entries through [DOLL DISC], [VOID], [VND CPN], [STR CPN], [BTL RTN] will result in over-subtraction of the subtotal amount at the time of the entry through any of those keys. If the status "Not required" is selected, over-subtraction using these keys will be allowed in the "REG" mode. The [RTN MDSE] key, negative departments, and negative PLUs are not subject to this "Credit Balance" status selection.
 - The "Negative-balance Sale" may be caused by:
 - Credit Balance if "Not required" is selected as the above Credit Balance status.
 - Amounts entered through the [RTN MDSE] key.
 - Other negative amounts.
 - The "Negative DEPT s or PLUs" are the DEPTs/PLUs programmed as negative status, but not normal DEPTs/PLUs through which Store Coupon or Returned Merchandise amounts are entered.

2.2 OTHER OPERATIONS REQUIRING MANAGER INTERVENTIONS

Amount Limit Release

Amount Limits may be programmed on Departments/PLUs, Tender Medias, **[DOLL DISC]**, **[VND CPN]**, **[STR CPN]**, **[BTL RTN]**. These limits are programmed to check an excessively high or low amount entry by cashier's mistake at the earliest stage. Guide your cashiers as in the following procedure:

(1) During sale entries by the cashier, an error occurs.



(2) The cashier clears the error by the **[C]** key. The cashier confirms the amount and operate the item again.



(3) If the same error occurs again, the cashier attempts to enter the amount using the **[LC OPEN]** or **[OPEN]** key.



(4) If the operation results in an error again, the Amount Limit cannot be solved by the **[LC OPEN]** or **[OPEN]** key.



(5) The cashier calls for Manager Intervention.



The procedure thereafter is the same as Steps 2) to 7) for the ITEMS PROGRAMMED TO REQUIRE MANAGER INTERVENTIONS. (Section 2.1)

■ In need of information of Amount Limits, see the following:

- 1) Individual Department High and Low Amount Limits (each PLU is restricted by the Amount Limits of its linked department): Ask your TOSHIBA TEC representative.
- 2) Departments Common High and Low Amount Limits, and High Amount Limits of Tender Media keys:
 - Chapter 7: VERIFICATION OF PROGRAMMED DATA
 - FUNCTION KEYS AMOUNT LIMIT READ
- 3) High Amount Limits for **[DOLL DISC]**, **[VND CPN]**, **[STR CPN]**, and **[BTL RTN]** keys:
 - Chapter 7: VERIFICATION OF PROGRAMMED DATA
 - NEGATIVE AMOUNT KEY AMOUNT LIMIT READ
- 4) For setting or changing the current Amount Limits, see the following:
 - Chapter 6: PROGRAMMING OPERATIONS
 - AMOUNT LIMIT SETTING FOR FUNCTION KEYS (Submode 8)
 - NEGATIVE AMOUNT KEY AMOUNT LIMIT SETTING OR CHANGING (Submode 35)

3. MANAGER’S OWN OPERATIONS IN “MGR” MODE

The following are operations possible only in the “MGR” position of the Mode Lock, which are performed by the manager or by a person under the manager’s control.

3.1. PICK UP OPERATION

This operation is used when you collect money from the ECR drawer, during the day, for the banking purpose, etc. In order to record the money amounts collected and to subtract the amounts from the In-drawer Totals memory , this operation is necessary.

OPERATION Any time outside a sale, in a Signed-ON condition.

OPERATION Mode Lock: **MGR**

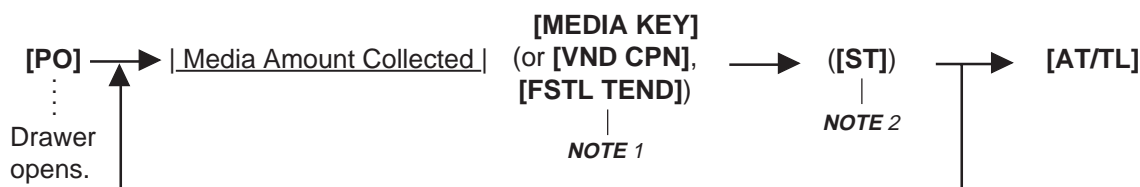

Repeat until all the collected media amounts are recorded.

- NOTES:**
1. As for each media and Food Stamp, its in-drawer limit amount can be programmed. On reaching this in-drawer limit when a sale is finalized, an alarm buzzer is generated to indicate that a Pick Up operation is necessary.
 2. Depress the media keys, **[VND CPN]** or **[FSTL TEND]** key corresponding to the collected media (**[AT/TL]** for cash). The media keys that can be operated here are those programmed to printed their media-in-drawer amounts in reports.
 3. Depress **[ST]**, if necessary, to obtain the subtotal amount of the medias so far collected.

Pick Up Operation Sample: The manager comes to the register and collects the cash amount of \$300.00 from the drawer:

Mode Lock: **MGR**

(must be in a signed-ON condition)

Depress **[PO]**.
 Enter 30000, depress **[AT/TL]**.
 Depress **[AT/TL]**.

-- Receipt Print Format --

```

    TEC STORE
    1343 PEACH DRIVE
    PHONE : 87-6437

    Open 8:00am to 7:00pm
    Closed : every Wednesday

    12-19-1994 MON #3001

    * PICK UP *
    CASH          $300.00
    TOTAL         $ 300.00

    JONES        0243 18:47TM
  
```

3.2. ENFORCED SIGN-OFF A CASHIER (CODE ENTRY METHOD)

Each cashier signs-ON to start operations, signs-OUT for leaving the register for a while, signs-IN when comes back, and signs-OFF to end operations (refer to the OPERATOR'S GUIDE).

However, when a cashier once signed-ON and then signed-OUT for taking a break does not come back (or the cashier may have operated a sign-OUT by mistake instead of a sign-OFF), the register cannot be operated. No one else can operate sign-OFF, either, because the same cashier must sign-IN first before sign-OFF. In this case, the manager may operate an Enforced Sign-OFF.

CONDITION

In a Signed-OUT condition

OPERATION

Mode Lock: **MGR**

The 2 digit Cashier Code
(manager-assign potion)

[LOG/RECEIPT] ... The same will result as the normal sign-OFF.
(or **[LOG]**)

01 to 99

The 2-digit code assigned to each cashier. As for the code opening and assigned cashier names, refer to the following:

For verifying the code and the assigned cashier's name:

Chapter 7: VERIFICATION OF PROGRAMMED DATA

- CASHIER CODE AND NAME READ

For programming or changing the cashier's names or assigned codes:

Chapter 6: PROGRAMMING OPERATIONS

- CASHIER CODE AND NAME PROGRAMMING AND DELETION (Submode 2)

-- Receipt Print Format --

TEC STORE	
1343 PEACH DRIVE	
PHONE : 87-6437	
Open 8:00am to 7:00pm	
Closed : every Wednesday	
12-19-1994 MON #3001	
* S I G N O F F *	
JONES	0250 18:51TM

4. OPERATIONS IN "☐" MODE

Instead of using the [RTN MDSE] or [VOID] keys in the "REG" or "MGR" mode for deleting individual items, the "☐" mode automatically processes positive items into negative and negative into positive. To operate, turn the Mode Lock to the "☐" position using the MA key, and enter the items, one by one, just as in the "REG" mode, as reading the sale receipt (issued at the time of the purchase) or tracing the returned items as if in the "REG" mode. A positive balance resulted in the "☐" mode indicates the amount to be paid back to the customer.

The "☐" mode operation may occur from time to time during day, on the cashier's request, just as in the case of ordinary Manager Interventions, when a customer to the cashier counter to return or cancel all the items that he once purchased. In using this mode, please be certain to read the following three cases of operation patterns. If you only turn the Mode Lock to the "☐" position and let the cashier operate the actual item entries in this mode, you should also inform the cashier of these three cases.

4.1. ORDINARY OPERATIONS IN "☐" MODE

All the sale items that were entered in "REG" or "MGR" at the time of purchase may be entered in the "☐" mode in the same way as operated at the time of purchase.

OPERATION AND RECEIPT SAMPLE

RECEIPT ISSUED IN "REG" or "MGR" MODE

TEC STORE	
1343 PEACH DRIVE	
PHONE : 87-6437	
Open 8:00am to 7:00pm	
Closed : every Wednesday	
12-19-1994 MON #3001	
VEGETABLE	\$2.50TF
Cheese-HalfPck	\$2.50TF
%+	
5%	-0.13T
TAX	\$0.30
CASH	\$ 5 . 1
7	
ITEM 2	
JONES	0252 18:51TM

These two receipts contain the same sale items and media finalization. The operations are also the same except the Mode Lock position.

The cashier merely follows the purchase receipt (on the left) and enters the same items in the ☐ position, finalizing with the same media in case a customer has returned or canceled the entire sale after the cashier had finalized that sale.

The ☐ mode header (*REG-* in this example) is printed at the top and the bottom of the sale contents in the ☐ mode receipt.

RECEIPT ISSUED IN "☐" MODE

TEC STORE	
1343 PEACH DRIVE	
PHONE : 87-6437	
Open 8:00am to 7:00pm	
Closed : every Wednesday	
12-19-1994 MON #3001	
* R E G - *	
VEGETABLE	\$2.50TF
Cheese-HalfPck	\$2.50TF
%+	
5%	-0.13T
TAX	\$0.30
CASH	5.17
ITEM 2	
JONES	0253 18:53TM
* R E G - *	

4.2. PROHIBITIVE OPERATIONS IN “☐” MODE

- NO-SALE ([NS])
- NO-SALE CASHING OF CHECK OR OTHER NON-CASH MEDIAS
- NO-SALE EXCHANGE from Foreign Currency to Domestic Currency, or vice versa
- LOAN
- PICK UP
- TRAINING MODE START/END
- VALIDATION PRINT
- ENDORSEMENT PRINT
- RECEIPT POST-ISSUE ([RECEIPT ISSUE])
- GCP FEED LINE NO. ENTRY ([GCP LINE#])
- Call NO. ENTRY

4.3. MANAGER INTERVENTION REQUIRED STATUS, AMOUNT LIMIT IN “☐” MODE

Since operations in the “☐” mode are performed under the manager’s control, the status requiring a Manager Intervention and Amount Limits (described in Chapter 2) will all be released, i.e., the same handling as in the “MGR” mode.

5. READ (X) AND RESET (Z) REPORTS

The following table shows the key operation to take each report. The “X” and “Z” reports have exactly the same print content if both are available, except that:

1. The “X” reports allow to read the sales data but not clear memories, while the “Z” reports allow to read the sales data and at the same time all the resettable memories will be cleared when the reports have been issue.
2. The symbol “X...” is printed on the top line of a Daily Read Report, “Z...” on a Daily Reset Report, “GTX...” on a GT Read Report, and “GTZ...” on a GT Reset Report, as initial settings.
3. A reset count is printed on the bottom of a “Z” report only.

WARNING!
<i>When opening the cash drawer, be careful not to let the drawer hit any person.</i>

TABLE OF OPERATIONS FOR X AND Z REPORTS

Daily Reports

REPORT NAME	MODE LOCK	KEY OPERATION	SAMPLE PAGE
FINANCIAL READ AND RESET <ul style="list-style-type: none"> • Financial Read • Financial Reset 	X Z	3 [AT/TL] (Drawer opens.)	14
CASHIER READ AND RESET <ul style="list-style-type: none"> • All Cashier Read • All Cashier Reset • Individual Cashier Read • Individual Cashier Reset 	X Z X Z	4 [ST] (Drawer opens.) <i>Code Entry Method:</i> 4 [#] Cashier ID Code [AT/TL] (2-digit manager-assign code) <i>Cashier Key Method:</i> Set the required Cashier Key (or depress the required Cashier Key), then 4 [#] [AT/TL]	16
SALESPERSON READ AND RESET <ul style="list-style-type: none"> • All Salesperson Read • All Salesperson Reset 	X Z	5 [AT/TL]	17
CREDIT CARD COMPANY SALES READ AND RESET <ul style="list-style-type: none"> • Credit Card Company Sales Read • Credit Card Company Sales Reset 	X Z	6 [AT/TL]	17
DEPARTMENT GROUP READ	X	8 [AT/TL]	18
MEDIA SALES AND IN-DRAWER TOTAL READ	X	9 [AT/TL] (Drawer opens.)	19

Daily Reports (Continued)

REPORT NAME	MODE LOCK	KEY OPERATION	SAMPLE PAGE
HOURLY RANGE READ AND RESET <ul style="list-style-type: none"> Hourly Read Hourly Reset 	X Z	10 [AT/TL]	19
DEPARTMENT READ AND RESET <ul style="list-style-type: none"> Individual Department Read All Department Read All Department Reset 	X X Z	11 [#], then depress the required Dept. Keys (or use [DP #] key), one by one, [ST] may be used to obtain subtotal, [AT/TL] to end. 11 [AT/TL]	20
ALL MEDIA SALES TOTAL AND CASH-IN-DRAWER READ	X	12 [AT/TL] (Drawer opens.)	17
PLU READ AND RESET <ul style="list-style-type: none"> Individual PLU Read Zone PLU Read Zone PLU Reset All PLU Read All PLU Reset Inactive PLU Read 	X X Z X Z X	<div style="text-align: center;"> </div> <p>* (May be replaced by [PLU Preset-code Key])</p> <div style="text-align: center;"> </div> <p>13 [AT/TL]</p> <p>13 [#] 0 [AT/TL]</p>	22
ORDER TABLE READ AND RESET (for Drive-through spec. only) <ul style="list-style-type: none"> All Order Table Read All Order Table Reset 	X Z	15 [AT/TL]	24
PLU GROUP SALES READ AND RESET <ul style="list-style-type: none"> PLU Group Sales Read PLU Group Sales Reset 	X Z	24 [AT/TL]	25

GT Reports -- to be taken on weekly or monthly basis --

REPORT NAME	MODE LOCK	KEY OPERATION	SAMPLE PAGE
(The Mode Lock position is the same as the corresponding Daily report. However, always add 200 to the numeric value for the report taking.)			
FINANCIAL GT READ AND RESET <ul style="list-style-type: none"> Financial GT Read Financial GT Reset 	X Z	203 [AT/TL] (Drawer opens.)	25
CASHIER GT READ AND RESET <ul style="list-style-type: none"> All Cashier GT Read All Cashier GT Reset Individual Cashier GT Read Individual Cashier GT Reset 	X Z X Z	204 [AT/TL] (Drawer opens.) <i>Code Entry Method:</i> 204 [#] Cashier ID Code [AT/TL] (2-digit manager-assign code) <i>Cashier Key Method:</i> Set the required Cashier Key (or depress the required Cashier Key), then 204 [#] [AT/TL]	25
CREDIT CARD COMPANY SALES GT READ AND RESET <ul style="list-style-type: none"> Credit Card Company Sales GT Read Credit Card Company Sales GT Reset 	X Z	206 [AT/TL]	25
DEPARTMENT GROUP READ	X	208 [AT/TL]	25
DEPARTMENT GT READ AND RESET <ul style="list-style-type: none"> Individual Department GT Read All Department GT Read All Department GT Reset 	X X Z	211 [#], then depress the required Dept. Keys (or use [DP#] key), one by one, [ST] may be used to obtain subtotal, [AT/TL] to end. 211 [AT/TL]	25
PLU READ AND RESET <ul style="list-style-type: none"> Individual PLU GT Read Zone PLU GT Read Zone PLU GT Reset All PLU GT Read All PLU GT Reset Inactive PLU GT Read 	X X Z X Z X	213 [#] PLU Code [PLU] ([ST]) Repeatable [AT/TL] *(May be replaced by [PLU Preset-Key]) 213 [#] Zone-start PLU Code [@/FOR] Zone-end PLU Code [AT/TL] 213 [AT/TL] 213 [#] 0 [AT/TL]	25
PLU GROUP SALES GT READ AND RESET <ul style="list-style-type: none"> PLU Group Sales GT Read PLU Group Sales GT Reset 	X Z	224 [AT/TL]	25

Combination Reports

Multiple reports can be programmed to be issued in one operation sequence. The following are reports programmable for combinations (max. 5 reports in one table, max. 3 tables). Ask your TOSHIBA TEC representative for information of the contents of your Combination Report Tables or for changes.

REPORT NAME	AVAILABLE REPORTS			
Financial Report	X	Z	GTX	GTZ
All Cashier Report	X	Z	GTX	GTZ
All Salesperson Report	X	Z		
Credit Company Sales Report	X	Z	GTX	GTZ
Department Group Report	X		GTX	
Media Sales and In-drawer Report	X			
Hourly Range Report	X	Z		
All Department Report	X	Z	GTX	GTZ
All Media Sales & Cash-in-drawer Report	X			
All PLU Report	X	Z	GTX	GTZ
All Order Tables Report	X	Z		
PLU Group Sales Report	X	Z	GTX	GTZ

KEY OPERATION: Mode Lock: X for Read
Z for Reset

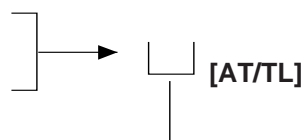

Enter the Report Combination-ID No.:

None (Simply depress **[AT/TL]**): Daily Combination Report Table No.1
 200: GT Combination Report Table No.1
 1: Daily Combination Report Table No.2
 201: GT Combination Report Table No.2
 2: Daily Combination Report Table No.3
 202: GT Combination Report Table No.3

- NOTES:**
1. When the mode set for taking combination reports does not match the mode of a report contained in the table, that report will be skipped.
 2. If no combination reports data have been programmed, Combination Report Table No.1 (which is issued by depressing the **[AT/TL]** key alone for Daily Reports and depressing 200 **[AT/TL]** for GT Reports) is auto-preset with All Department Report and Financial Report. It will be active as table No.1 content unless no data are programmed for Table No.1.
 3. The report output order is determined by the order programmed in each table.
 4. The drawer will open when a contained report is ruled to open the drawer.

GENERAL NOTES ON REPORT TAKINGS

1. The cashier signed-OFF or signed-OUT condition is required for taking any X or Z reports in the Code Entry Method. (Otherwise, an error will result when the Mode Lock is turned to the "X" or "Z" position.)
2. Reset reports will be printed on the receipt roll as well as on journal, and issued, regardless of the current Receipt ON/OFF status.
3. The **[ITEM CORR]** (or **[VOID]**) key may be depressed halfway during printing a report, for the purpose to abort the receipt issuance (except for some short reports). When a report-abort has been operated for a reset report, the memory of the report data will not be cleared.
4. The drawer will open at the starting of printing the reports which are stated with "(Drawer opens)" in the Daily and GT report table. However, the drawer may remain closed if so selected by a program option. This selection is applied only to the financial report.
5. The sales data of the following read reports will be cleared when the relevant reset reports are cleared. If those read reports are necessary, please be certain to take them before the relevant reset reports are taken:

READ REPORT (with no reset reports provided)	RELEVANT RESET REPORT that clears the read report data
Department Group Read	All Department Reset
Media Sales and In-drawer Total Read	Financial Reset
All Media Sales Total and Cash-in-drawer Read	Financial Reset
Inactive PLU Read	PLU Reset
Department Group GT Read	All Department GT Reset
Inactive PLU GT Read	PLU GT Reset

As you notice, "Financial Reset", "All Department Reset", and "PLU Reset" reports should be taken after all other reports (particularly read reports) on the respective levels of daily and GT, so that the required read reports data may not be cleared by those reset report takings.

FINAL READ or RESET (Daily or GT)

Mode Lock: **X** for read Enter 3, depress **[AT/TL]** (for Daily)
 Z for reset Enter 203, depress **[AT/TL]** (for GT)

Reset Report Format Sample

- NOTES:**
1. The numeric values placed in reports in this manual are merely examples to show the print format and may not balance correctly.
 2. The items attached with "*" outside the receipt frame are printed only on Daily Reports but not on GT Reports.
 3. The print or non-print status of each item on Financial Reports can be programmed.
 4. Non-printing of items with zero sales (i.e., zero skip) can be programmed by a program option.

TEC STORE		
1343 PEACH DRIVE		
PHONE : 87-6437		
Open 8:00am to 7:00pm		
Closed : every Wednesday		
19-12-1994 MON #3001		Date, Day-of-Week, Store/Register No.
Z F I N A N C I A L		Report Name
GT		Grand Total (non-resettable)
NET GT	\$346.77	Net GT (non-resettable)
GS	\$309.09	Gross Sale Item Count
	125	& Amount
NS	\$346.77	Net Sale Without Tax Item Count
	112	& Amount
TAX1	\$300.48	Percent Charge I, II Count & Amount
TAX5	\$17.20	GST Amount
NS	\$0.50	Tax 1 Amount
	112	Manual Tax Amount
HASH DP	\$318.18	Net Sale With Tax Item Count
	1	& Amount
%-	\$1.40	Total of Positive Departments programmed as OTHER INCOME, Item Count
V.CPN	4	Charge Tip Count & Amount
	\$2.34	Percent Discount (on Subtotal) Count
DISC	1	Total of Negative Departments programmed as OTHER INCOME, Item Count & Amount
	\$4.00	Percent Discount II (on Subtotal) Count & Amount
BTR	1	Vendor Coupon Count
	\$1.00	if two Percent Discount keys are installed.
TOTAL	6	& Amount
CASH	\$0.35	Dollar Discount (on Subtotal) Count
CHECK	71CU	& Amount
FS TL	\$310.49	Bottle Return Item Count
R/A	71CU	& Amount
PO	\$292.77	All-media Sales (including CASH, FS TL, and PB TL)
CASH ID	0CU	Customer Count & Amount
CHECK ID	\$5.00	Cash Sales
FSID	1CU	Customer Count & Amount
FS CG	\$12.72	Check Sales
	2	Customer Count & Amount
	\$8.00	Food Stamp Sales
	8	Customer Count & Amount
	\$37.10	Received-on Account Count
	\$95.02	& Amount
	2	Paid-Out Count
	\$15.00	& Amount
	1	Cash-in drawer Amount
	\$13.00	Check in-drawer Count
	\$0.28	& Amount
		Food Stamp-in-drawer Count
		& Amount
		Food Stamp Change Amount
		Tip Paid Count & Amount

-- to be continued --

(Financial Read or Reset)

-- Continued --

			←		<i>Eat-in Customer Count & Amount</i>
			←		<i>Takeout Customer Count & Amount</i>
CORR	1		←	Item Correct (on positive Depts/PLUs) Count & Amount	
	\$1.00				
VOID	1		←	Void Count & Amount	
	\$1.00				
ALL VD	2		←	All Void Count & Amount	<i>Miscellaneous Void Count & Amount</i>
	\$8.60				
%-	11		←	Percent Discount (on Line Items) Count & Amount	
	\$2.02				
DISC	4		←	Dollar Discount (on Line Items) Count & Amount	<i>Percent Discount II (on Line Items) Count & Amount if two Percent Discount keys are installed.</i>
	\$2.00				
S. CPN	2		←	Store Coupon Item Count & Amount	
	\$1.00				
RTN	4		←	Returned Merchandise Item Count & Amount	<i>Negative Departments Item Count & Amount</i>
	\$3.80				
-TAX	\$0.22			Negative Tax Amount	
-SALE	4CU			Negative-balance Sales Customer Count & Amount	
	\$5.37				
REG-	2		←	Negative Mode (☐ Mode) Count & Amount	<i>Transfer + Daily</i>
	\$7.95				
TRF-	\$0.03		←	Transfer - Daily	
PB TL	1CU			Previous Balance Sales Customer Count & Amount	<i>GST Taxable Total</i>
	\$0.00				
TXBL1	\$284.98		←	Taxable Total 1 (Sale Amount Portion subject to Tax 1 taxation)	
TXBL2	\$58.20		←	Taxable Total 2 (Sale Amount Portion subject to Tax 2 taxation)	<i>Taxable Total 3,4</i>
SI1 TL	2		←	Selective Itemizer 1 Count & Amount calculated out or processed	
	\$1.40				
TAX EX	1CU		←	Tax Exempted Customer Count	<i>Selective Itemizer 2 Count & Amount</i>
GST EX	\$5.00		←	Sale Portion Exempted from GST	<i>FS EX1 to FS EX4 for Taxes exempted by tendering food stamps if ILLINOIS or NEW JERSEY type of food stamp system</i>
TAX1 EX	\$10.00		←	Sale Portion Exempted from Tax 1	
* CUR 1	3		←	The amounts are expressed in the respective currencies' units	<i>Sales Portion Exempted from Tax 2 to 4</i>
	150.00				
* CUR 2	1				
	5.68				
* CUR 3	1		←		
	1.45				
* CUR RND	18.00		←	Foreign Currency Rounding Amount	<i>* Foreign Currencies 4 & 5-in-drawer data if opened.</i>
ITEM/CUS	1.58			Sales Item Count per Customer	
NS/CUS	\$4.23			Net Sale Amount per Customer	
* NO SALE	3			No-sale Count	
* VALI CTR	2			Validation Print Count	
* TRAY CTR	1			Tray Total Operation Count	
0001Z				Financial Reset Report Count (on Reset Reports only)	
	0260 18:58TM				

CASHIER READ or RESET (Daily or GT)

Mode Lock: **X** for read
Z for reset

**Reset Report
 Format Sample**

TEC STORE	
1343 PEACH DRIVE	
PHONE : 87-6437	
Open 8:00am to 7:00pm	
Closed : every Wednesday	
12-19-1994 MON #3001	
Z C L E R K	
01 JONES	
G S	125
	\$346.77
N S	112
	\$300.48

ITEM/CUS	1.56
NS/CUS	\$4.17
NO SALE	2
TRAY CTR	1
0001Z	
02 SMITH	
* T R A I N I N G *	
03 MEHL	

* T R A I N I N G *	
04 BROWN	
G S	9
	\$22.80
N S	9
	\$21.50
TAX1	\$1.30
N S	9
	\$22.80
TOTAL	5CU
CASH	\$22.80
	\$22.80
CASH ID	\$22.80
TXBL1	\$21.50
ITEM/CUS	1.80
NS/CUS	\$4.30
0001Z	
0261 18:58TM	

(1) All Cashiers:

Enter 4, depress **[AT/TL]** (for Daily).
 Enter 204, depress **[AT/TL]** (for GT).

(2) Individual Cashier:

Enter 4, depress **[#]**, enter the Cashier ID Code (2 digits),
 and depress **[AT/TL]** (CODE ENTRY Method) (for Daily)

Set the required Cashier Key to ON, enter 4, depress **[#]**
 and **[AT/TL]** (CASHIER KEY Method) (for Daily)

Enter 204, depress **[#]**, enter the Cashier ID Code (2 digits),
 and depress **[AT/TL]** (CODE ENTRY Method) (for GT)

Set the required Cashier Key to ON, enter 204, depress **[#]**
 and **[AT/TL]** (CASHIER KEY Method) (for GT)

Cashier ID Code & Cashier's Name

In CASHIER SIGNING Method, the ID code here is the 2-digit
 manager-assign portion of the Cashier Code

Same contents as Financial Reports except for GT and NET GT

Individual Cashier Reset Report Count (on Reset Reports only)

DAILY SALESPERSON READ OR RESET

(all Salespersons)

Mode Lock: **X** for read] Enter 5,
Z for reset] depress **[AT/TL]**

TEC STORE
 1343 PEACH DRIVE
 PHONE : 87-6437
 Open 8:00am to 7:00pm
 Closed : every Wednesday
 12-19-1994 MON #3001
Z S L S P E R S O N
 02 Stacy
G S 2
 \$2.65
N S 2
 \$2.50
N S 2
 \$2.65
 RTN 0
 \$0.00
 0001Z
 0267 19:00TM

Reset Report Sample

Person Code, Name
 Gross Sale Item Count
 & Amount
 Net Sale Without Tax, Item Count
 & Amount
 Net Sale With Tax, Item Count
 & Amount
 Returned Merchandise Item Count
 & Amount

All Salesperson Reset Report
 Count (on Reset Reports only)

**CREDIT CARD COMPANY SALES READ or
 RESET (Daily or GT)**

(read only)

Mode Lock: **X** for read] Enter 6, depress
Z for reset] **[AT/TL]** (for Daily)
 Enter 206, depress
 [AT/TL] (for GT)

TEC STORE
 1343 PEACH DRIVE
 PHONE : 87-6437
 Open 8:00am to 7:00pm
 Closed : every Wednesday
 12-19-1994 MON #3001
X C R E D I T
 01 ABC 1
 \$5.30
 TOTAL 1
 \$5.30
 0001Z
 0268 19:00TM

Company Code, Name, Count
 & Sales Amount
 Total of all card companies'
 sales (Item Count & Amount)

Credit Card Co. Sales Reset
 Report Count (on Reset
 Reports only)

**DAILY ALL MEDIA SALES TOTAL AND CASH-
 IN-DRAWER READ (read only)**

Mode Lock: **X**, enter 12, depress **[AT/TL]**

TEC STORE
 1343 PEACH DRIVE
 PHONE : 87-6437
 Open 8:00am to 7:00pm
 Closed : every Wednesday
 12-19-1994 MON #3001
X M E D I A
 TOTAL 72CU
 \$315.79
 CASH ID \$95.02
 0269 19:01TM

All-media Sales Total Customer
 Count, Amount
 Cash-in-drawer Amount

DEPARTMENT GROUP READ (Daily or GT)

(read only)

Mode Lock: **X**,

Enter 8, depress **[AT/TL]** (for Daily).

Enter 208, depress **[AT/TL]** (for GT).

TEC STORE			
1343 PEACH DRIVE			
PHONE : 87-6437			
Open 8:00am to 7:00pm			
Closed : every Wednesday			
12-19-1994 MON #3001			
X G R O U P			
V E & F R	41	Minor Groups:	Group Name, Item Count
46.51%	\$153.20		Sales Percentage & Amount
M E & F I	11	:	
9.17%	\$30.19	:	
D A I R Y	20	:	
12.41%	\$40.89	:	
B A K E R Y	11	:	
15.28%	\$49.24		
D A & B T	15		
14.06%	\$46.30		
D A & B L	14		
6.59%	\$21.70		
S N & S P	2		
6.07%	\$20.00		
O T H E R S	2		
1.06%	\$3.50		
TOTAL	125	Item Count }	Total of
	\$329.38	Amount }	all Minor Groups
F R E S H			
72.22%	\$237.88	Major Groups:	:
M A N U F	40	:	
26.72%	\$88.00	:	
O T H E R	2	:	
1.06%	\$3.50		
TOTAL	125	Item Count }	Total of
	\$329.38	Amount }	all Major Groups
0270 19:01TM			

**DAILY MEDIA SALES AND IN-DRAWER
TOTAL READ (read only)**

DAILY HOURLY RANGE READ or RESET

Mode Lock: **X**, enter 9, depress **[AT/TL]**

Mode Lock: **X** for read **Z** for reset] Enter 10, depress **[AT/TL]**

```

TEC STORE
1343 PEACH DRIVE
PHONE : 87-6437

Open 8:00am to 7:00pm
Closed : every Wednesday

12-19-1994 MON #3001

X MEDIA ALL
TOTAL          72CU
                $315.79
CASH           71CU
                $292.77
CHECK          0CU
                $5.00
Chg            1CU
                $5.30
FS TL         1CU
                $12.72
CASH ID       $95.02
CHECK ID      2
                $15.00
Chg ID        1
                $5.30
FS ID         1
                $13.00
FS CG         $0.28
PB TL        1CU
                $0.00
CUR1          3
                150.00
CUR2          1
                5.68
CUR3          1
                1.45

                0271 19:01TM
    
```

All-media Sales Customer
Count & Amount

Each Media Sales
Customer Count &
Amount

Each Media-in -drawer
Count & Amount

Food Stamp Change
Previous Balance Sales
Customer Count & Amount
Each Foreign Currency-in-drawer
Count & Amount

```

TEC STORE
1343 PEACH DRIVE
PHONE : 87-6437

Open 8:00am to 7:00pm
Closed : every Wednesday

12-19-1994 MON #3001

Z HOURLY
08:00TM
12:00TM
15:00TM      114
              72CU      $323.48
19:00TM

0001Z

                0272 19:01TM
    
```

Reset Report Sample

8:01 to 12:00
12:01 to 15:00
15:01 to 19:00 Item Count
Cus. Count & Amount
19:01 and thereafter

Hourly Range Reset Report Count
(on Reset Reports only)

DEPARTMENT READ or RESET

Individual Department Read (Daily or GT)

Operation for this sample report:

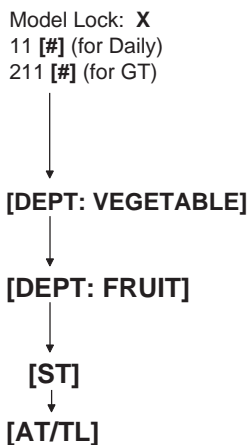

TEC STORE	
1343 PEACH DRIVE	
PHONE : 87-6437	
Open 8:00am to 7:00pm	
Closed : every Wednesday	
12-19-1994 MON #3001	
X D P I N D I V	
VEGETABLE	32
29.03%	\$95.20
FRUIT	10
17.68%	\$58.00
SUBTL	42
	\$153.20
TOTAL	42
	\$153\$20
0273 19:02TM	

Mode Lock: **X**

Enter 11 and depress **[#]** for Daily Report, or
 Enter 211 and depress **[#]** for GT Report

Depress the required Dept Keys (or enter the required Dept Code and depress **[DP#]**), repeat this for other required DEPTs, depress **[ST]** if subtotal is necessary, depress **[AT/TL]** to end reading.

Department Name
 Item Count
 Customer Count (or Sales Percentage NOTE), Amount

⋮
 ⋮
 ⋮

Item Count } Subtotal of VEGETABLE + FRUIT
 Amount }
 Item Count } Total of all departments read in this report
 Amount }

NOTE: A program option allows to select which of Customer Count and Sales Percentage is printed here.

All Department Read or Reset (Daily or GT)

Mode Lock: **X** for read] Enter 11, depress **[AT/TL]** (for Daily).
 Z for reset] Enter 211, depress **[AT/TL]** (for GT).

TEC STORE
 1343 PEACH DRIVE
 PHONE : 87-6437

 Open 8:00am to 7:00pm
 Closed : every Wednesday

 19-12-1994 MON #3001

Z D P A L L
 VEGETABLE 33
 30.30% \$101.20

Reset Report Sample

Department Data fl
 Dept. 1 Name,
 Item Count
 Customer Count (or Sales %), Amount

⋮
 ⋮
 ⋮
 ⋮

D P 15 1
 \$1.00

 TOTAL 126
 \$333.98

V E & F R 42
 47.47% \$159.20
M E & F I 11
 9.00% \$30.19
D AIRY 20
 12.19% \$40.89
B AKERY 11
 4.06% \$13.60
C A & B T 24
 12.19% \$40.89
D R & B L 14
 6.47% \$21.70

Dept. 15 Data:

Item Count
 Amount

Minor Group and Major Group Data fl

Refer to Department Group Read Report for details.

PLU (PLU SALES DATA) READ or RESET**Individual PLU Read (Daily or GT)**

TEC STORE
 1343 PEACH DRIVE
 PHONE : 87-6437

Open 8:00am to 7:00pm
 Closed : every Wednesday

12-19-1994 MON #3001

X	PLU	INDIV	
	020102		
	Lemon		
	1		\$1.00
	020105		
	Apple		
	0		\$0.00
	SUBTL	1	\$1.00
	TOTAL	1	\$1.00

0297 19:13TM

Mode Lock: **X**Enter 13 **[#]** for Daily Report, orEnter 213 **[#]** for GT Report .Enter the PLU code, depress **[PLU]**. (Repeat this step if necessary.)Depress **[ST]** for subtotal.Depress **[AT/TL]** to end.OPERATION FOR THISSAMPLE REPORT:Mode Lock: **X**13 **[#]**20102 **[PLU]**20105 **[PLU]****[ST]** to obtain subtotal
of the above two PLUs.**[AT/TL]** to end**Zone PLU Read or Reset (Daily or GT)****Read Report Sample**

TEC STORE
 1343 PEACH DRIVE
 PHONE : 87-6437

Open 8:00am to 7:00pm
 Closed : every Wednesday

12-19-1994 MON #3001

X	PLU	ZONE	
		100000~199999	
	101301		
	Small-Btl Depo		
	4		\$0.20
	TOTAL	4	\$0.20

0276 19:05TM

Mode Lock: **X**Enter 13 **[#]** for Daily Report, orEnter 213 **[#]** for GT Report.Enter the zone-start PLU code, depress **[@/FOR]**.Then enter the zone-end PLU code, depress **[AT/TL]**.For this sample13 **[#]** (for Daily)100000 **[@/FOR]**199999 **[AT/TL]**

Zone-start PLU Code ~ Zone-end PLU Code

PLU Code

PLU Name

Item Count, Amount

Item Count, Amount of Total of all PLUs read in this report

NOTE: In Zone PLU Read Reports:

- PLUs of zero sale will be skipped.
- PLUs not existing in the PLU Program File memory will not be printed in reports (in any reports).

All PLU Read or Reset (Daily or GT)

INACTIVE PLU READ (Daily or GT) (read only)

TEC STORE
 1343 PEACH DRIVE
 PHONE : 87-6437

Open 8:00am to 7:00pm
 Closed : every Wednesday

12-19-1994 MON #3001

Z P L U A L L

010101		
Tomato		
3		\$0.50
020102		
Lemon		
1		\$1.00
050301		
Milk-Large Pack		
1		\$1.30
050321		
Cheese-Half Pck		
13		\$32.50
050322		
Egg-6 Pack		
1		\$1.50
060404		
Half Rolls-4		
1		\$0.80
070501		
Tuna Can		
12		\$4.20
070502		
Soup Can		
4		\$1.20
080502		
Kiwi Jam		
1		\$2.20
090601		
Coke-Small-B		
2		\$1.20
101301		
Small-Btl Depo		
4		\$0.20
TOTAL	43	\$46.60
0001Z		

0277 19:06TM

Mode Lock: **X** or **Z**
 13 **[AT/TL]** (for Daily),
 or 213 **[AT/TL]** (for GT)

Reset Report Sample
*Prints data in order from
 lower to larger numbered
 PLU Code.*

PLU Code 10101
 Name "Tomato"
 Item Count, Amount

PLU Code 101301

Total Item Count and
 Amount of all the PLUs
PLU Reset Report Count
 (on Reset Reports only)

TEC STORE
 1343 PEACH DRIVE
 PHONE : 87-6437

Open 8:00am to 7:00pm
 Closed : every Wednesday

19-12-1994 MON #3001

Z P L U Z E R O

010102	
Potato	
020101	
Orange	
020105	
Apple	
030301	
Beef	
030302	
Pork	
030303	
Mutton	
040201	
Salmon	
040202	
Cod	
040203	
Shrimp	
050302	
Milk-Small Pack	

0278 19:06TM

Mode Lock: **X**
 13 **[#]** (Daily), or
 213 **[#]** (GT).

Enter 0 (zero), depress
[AT/TL].

PLU Code
 Name
 :
 :
 :
 :

DAILY ORDER TABLE READ OR RESET (All Order Tables) (for Drive-through spec. only)

Mode Lock: **X** for read] Enter 15, depress **[AT/TL]**
Z for reset]

TEC STORE
 1343 PEACH DRIVE
 PHONE : 87-6437

Open 8:00am to 7:00pm
 Closed : every Wednesday

12-19-1994 MON #3001

Z O R D E R A L L

Order Table No.	#01	3	\$3.24
	#02	4	\$9.11
	#03	6	\$7.28
	0001Z		

0280 19:10TM

Reset Report Sample

Net Sale with Tax, Item Count
& Amount

All Order
 Tables Reset
 Report Count
 (On Reset Reports only)

PLU GROUP SALES READ or RESET (Daily or GT)

TEC STORE
 1343 PEACH DRIVE
 PHONE : 87-6437

Open 8:00am to 7:00pm
 Closed : every Wednesday

19-12-1994 MON #3001

Z P L U G R O U P

VEGETABLE	4	
3.22%	\$1.50	
MEAT & DAIRY	15	
75.75%	\$35.30	
BAKERY	1	
1.72%	\$0.80	
CAN & BTL FOOD	17	
16.31%	\$7.60	
DRINK	1	
2.58%	\$1.20	
BTL DEPO	4	
0.43%	\$0.20	
TOTAL	43	
	\$46.60	
0001Z		
	0279 19:07TM	

Mode Lock: **X** for read Enter 24, depress **[AT/TL]** (for Daily).
Z for reset Enter 224, depress **[AT/TL]** (for GT).

Reset Report Format Sample

PLU Group Name
Item Count
Sales Percentage, Amount
:
:
:
:
:

PLU Group Sales Reset Report Count (on Reset Reports only)

GT REPORTS

The print form and item of a GT report are same as those of its corresponding daily report, except the report header portion. Please also note that some items provided in the daily report are not provided in its GT reports. The counters and totals in a GT report are records accumulated for a certain period (week, month, etc.) While those counters and totals in the daily report are usually records for a day. The accumulated record data in each GT report will be renewed when its GTZ report has been taken.

Header Example

X DP ALL

All Department Read Report
(Daily)



GTX DP ALL

All Department GT Read Report

6. PROGRAMMING OPERATIONS

This chapter is provided for the store programmer or the store manager who may have to change the programmed data of the FS-1450 series ECR on the daily, weekly, or monthly basis. Usually, all the basic program data required for your store should be set before delivering the product by your local TOSHIBA TEC representative. However, in need of changing or adding program data, please refer to this chapter. It is also recommended to read the OPERATOR'S GUIDE as well as other chapters of the MANAGER'S GUIDE in order to thoroughly understand the descriptions in this chapter. If there are any unclear points or program data other than listed here must be changed or added, please contact your TOSHIBA TEC representative.

TABLE OF PROGRAMMING OPERATIONS

	(page)
-- BASIC KEY FUNCTIONS AND KEYBOARD VARIATIONS IN PROGRAMMING OPERATIONS -- ...	27
-- CHARACTER ENTRIES --	28
-- CONDITION REQUIRED FOR PROGRAMMING OPERATIONS --	33
Submode No. 1: STORE NAME/MESSAGE AND COMMERCIAL MESSAGE PROGRAMMING ..	34
Submode No. 2: CASHIER CODE AND NAME PROGRAMMING	36
Submode No. 4: PLU TABLE PROGRAMMING	39
Submode No. 5: TIME SETTING OR ADJUSTMENT	46
Submode No. 6: DATE SETTING OR ADJUSTMENT	46
Submode No. 8: AMOUNT LIMIT SETTING FOR FUNCTION KEYS	47
Submode No. 20: SALESPERSON CODE AND NAME PROGRAMMING	48
Submode No. 27: PLU PRESET- CODE KEY SETTING	50
Submode No. 35: NEGATIVE AMOUNT KEY LIMIT AMOUNT SETTING	52
Submode No. 42: SET MENU TABLE PROGRAMMING	53
No Submode No.: DEPARTMENT PRESET PRICE SETTING OR CHANGING	54
PLU PRESET PRICE SETTING OR CHANGING, WHOLE PACKAGE QUANTITY CHANGING	55
%+ AND %- PRESET RATE SETTING	57
PRESET RATE SETTING FOR SELECTIVE ITEMIZERS	58
FOREIGN CURRENCY EXCHANGE RATE SETTING	60
TAX TABLE PROGRAMMING	62
GST RATE SETTING	65
STORE/REGISTER NO. SETTING	66

BASIC KEY FUNCTIONS AND KEYBOARD VARIATIONS IN PROGRAMMING OPERATIONS

Basic Key Functions

1. The following are main keys and their functions to be used in programming operations:

[X] or **[@/FOR]** Used to enter the program Submode No. The **[X]** key is usually labeled as **[@/FOR]** on the ECR keyboard.

[ST] Used to enter the Address No. or Item Code. Also used to end the item data entries.

[#] Used to enter data for the address or item. Each character code is also entered through this key.

[AT/TL] Used to end the entire program Submode sequence.

2. Functions of the **[C]** key:

- When an entered program data is already printed, the **[C]** key cannot clear it any longer. To correct the data, re-enter it.
- Before the entered data is printed, the data may be cleared by the **[C]** key.

Keyboard Variations in Programming operations

The FS-1450 adopts a Flat keyboard.

The Flat keyboard will be set with the "Setting Mode Key Layout" in the programming operations including the character entries.

The following operations may be executed with the "Setting Mode Key Layout."

- STORE NAME/MESSAGE AND COMMERCIAL MESSAGE PROGRAMMING (Submode 1)
- CASHIER CODE AND NAME PROGRAMMING (Submode 2)
- PLU TABLE PROGRAMMING (Submode 4)
- SALESPERSON CODE AND NAME PROGRAMMING (Submode 20)

However, other operations (Which do not contain the character entries) should be operated with the ordinary "REG" mode key layout.

- NOTES:**
1. *If an option keyboard (PK-2) is connected, the DIRECT CHARACTER ENTRY method is allowed through both the ECR keyboard and the option keyboard.*
 2. *Any character not found in "Setting Mode Key Layout" should be programmed by following the CHARACTER CODE ENTRY procedure. (Characters on the key sheet can also be programmed by following this procedure.)*

CHARACTER ENTRIES

As already stated, there are two method of operations for character settings for names or messages: CHARACTER CODE ENTRY Method and DIRECT CHARACTER ENTRY Method.

CHARACTER CODE ENTRY Method

This method is to set a character by entering a Character Code and depressing the [#] key. This method is allowed only on the ECR keyboard.

DIRECT CHARACTER ENTRY Method

This method is to set a character by directly depressing the Character Key on any of the following keyboard:

- Flat Keyboard with “Setting Mode Key Layout” sheet.
- PK-2 Keyboard (PLU Keyboard; hardware option)

By using those character keys, the characters are directly entered. In this manual sample operations are attached to most of the programming operations. And at name or message programming portions, characters are entered by the DIRECT CHARACTER ENTRY method.

On the following pages, Character Code Tables under the CHARACTER CODE ENTRY Method and two different keyboards under the DIRECT CHARACTER ENTRY Method are shown. These pages are to be referred to, every time the “Character Entries” sequence is contained in various programming operations in this manual.

Read through these pages at least once first, so that you may know the appropriate method of character entries using the ECR keyboard and/or option keyboards.

Character Code Entry Method

Character Code Table 1: Standard Characters

		Column Code →													
		2	3	4	5	6	7	8	9	10	11	12	13	14	15
Row Code ↓	00		0	@	P	`	p			////	á	Å	\		fi
	01	!	1	A	Q	a	q				é	å	ll		<
	02	"	2	B	R	b	r			ø	í	Ø	lll		fl
	03	#	3	C	S	c	s			ß	ó	ø	ll		>
	04	\$	4	D	T	d	t			,	ú	Æ	—		$\frac{1}{2}$
	05	%	5	E	U	e	u			•	â	æ	—D		$\frac{1}{4}$
	06	&	6	F	V	f	v			Ä	ê	Œ	ƒ		★
	07	ç	7	G	W	g	w			Ë	î	œ			◊
	08	(8	H	X	h	x			Ö	ô	ß			kg
	09)	9	I	Y	i	y			Ü	û	ç			lb
	10	*	:	J	Z	j	z			É	à	£			No
	11	+	;	K	[k	{			ä	è	F			.
	12	,	<	L	¥	l				ë	ì				▽
	13	-	=	M]	m	}			ï	ç	,			△
	14	.	>	N	^	n	~			ö	Ñ	—			□
15	/	?	O	_	o	□			ü	ñ	⊖				

Character Setting Operations:

- To set a regular-sized character, enter the COL (column) code and then the ROW code, followed by the [#] key.

ex.) To set “%”, enter 205 and depress [#].
To set “kg”, enter 1508, and depress [#].

To set a blank instead of a character, simply depress [#] without a prior code entry, or enter 200 and depress [#].

Depress the [X] (or [@/FOR]) key once prior to a regular-sized character entry and it will be a double-sized character (a blank will also be double-sized).

ex.) To set “GROUP”, “G” in double-sized, and “ROUP” in regular-sized:

<u>[X] 407 [#]</u>	<u>502 [#]</u>	<u>415 [#]</u>	<u>505 [#]</u>	<u>500 [#]</u>
G	R	O	U	P

- Depress the [X] key twice prior to the first character code entry to set the entire message line or entry name with all double-sized characters.

ex.) To set “GROUP” all in double-sized:

<u>[X] [X]</u>	<u>407 [#]</u>	<u>502 [#]</u>	<u>415 [#]</u>	<u>505 [#]</u>	<u>500 [#]</u>
G	R	O	U	P	

|
All Double-sized Declaration

Direct Character Entry Method

Using Flat Keyboard (installed as the ECR Main Keyboard):

-- Setting Mode Key Layout --

(Use the special template for this purpose and insert it between the film layers covering the Flat Keyboard. This key layout is applicable to only certain submodes.)

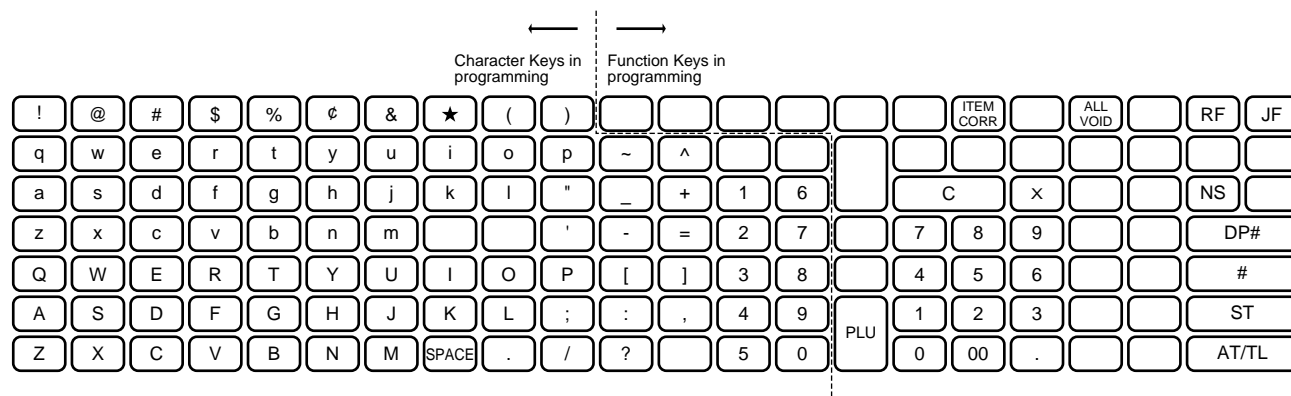

Character Keys: Simply depress the key to enter the character. (The [#] key should not follow.) The numerics 1 to 0 are entered as characters 1 to 0 but not as codes for PLU Item Codes, etc.

The One Double-size Declaration (by depressing [X] key once prior to the required character and the All Double-size Declaration (by depressing [X] twice before the characters) are the same as in the CHARACTER CODE ENTRY method.

Function Keys: These are function keys to be used in programming operations with the Setting Mode Key Layout. The Numeric Keys here are used to enter PLU Codes, etc. or numeric values as program data, but not to enter the numerics as characters.

Using PK-2 (PLU Keyboard; hardware option)

The PK-2 is used to enter a required PLU code by simply depressing the code-preset key on the PK-2 keyboard in the REG or MGR mode. In addition, the PK-2 can be used to enter characters directly during the programming operations that require character settings, such as STORE NAME/MESSAGE AND COMMERCIAL MESSAGE PROGRAMMING, PLU TABLE PROGRAMMING, etc.

The figure below shows the key indications of the PK-2 keyboard for the character setting purpose. Insert the template for this purpose between the film layers that cover the PK-2 keyboard.

Instead of entering a 3- or 4-digit character code and depressing the [#] key on the ECR keyboard, a simple depression of the appropriate key on the PK-2 keyboard will be the character entry.

All the function keys, such as [X], [ST], [AT/TL], etc. must be operated on the ECR side. Any characters not listed on the template may be entered by the CHARACTER CODE ENTRY method on the ECR keyboard (the characters even listed on the template may be entered as well by that method).

Please note also that keys "0" to "9" in the figure below function as character keys but do not function for code entries. Any code entries, for Menu Item Codes, Address Nos, etc. must be entered through the Numeric Keys on the ECR keyboard.

The One Double-size Declaration (by depressing the [X] key once prior to the required character) and the All Double-sized Declaration (by depressing [X] twice before all the characters) are the same as in the CHARACTER CODE ENTRY method.

										7	8	9
										4	5	6
										1	2	3
!	@	#	\$	%	¢	&	*	()		0	
q	w	e	r	t	y	u	i	o	p	~	^	
a	s	d	f	g	h	j	k	l	"	_	+	
z	x	c	v	b	n	m			'	-	=	
Q	W	E	R	T	Y	U	I	O	P	[]	
A	S	D	F	G	H	J	K	L	;	:	,	
Z	X	C	V	B	N	M	space	.	/	?		

CONDITION REQUIRED FOR PROGRAMMING OPERATIONS

At the top of each programming operation a “CONDITION” is given. Unless the register satisfies condition, the programming operations will not be allowed.

There are two types of conditions:

“Any time outside a sale”

It means that the programming operation is allowed when a sale is finalized before going into any other sale entry.

“After ... Reset”

It means that the designated reset report must be taken before entering the programming operation. And an error will result if the operation is attempted without taking the report. However, the words “After ... Reset” do not necessarily mean “immediately after ...”.

When the designed reset report has already been taken and then some operations are performed in the SET, X or Z mode, the condition “After ... Reset” is still satisfied and the programming operation is still allowed.

On the contrary, when the designated reset report has been taken but then some sales data relating to that report’s output data are entered in the REG, MGR, or mode, the programming operation will no longer be allowed and the same reset report must be taken.

Thus the condition “After ... Reset” indicates that all the sales data relating to the report data must be zero (except non-resettable memory data). Because of this “CONDITION” requirement, the report data will be protected from any inconsistencies of sales data entered in the period from a resetting of the report to another resetting of the same report next time.

STORE NAME/MESSAGE AND COMMERCIAL MESSAGE PROGRAMMING (Submode 1)

CONDITION Any time outside a sale

OPERATION Mode Lock: SET

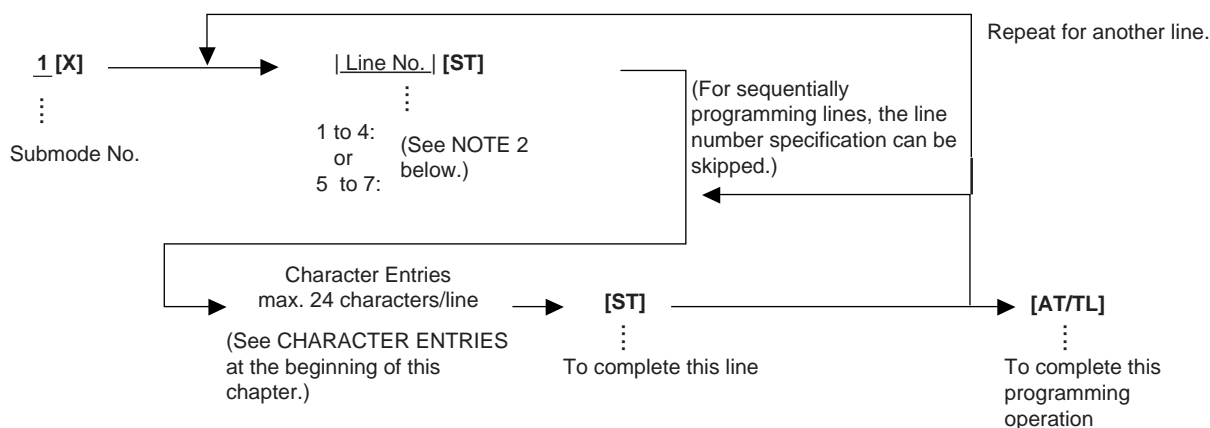

NOTES:

1. For each line, a maximum of 24 regular-size characters or 12 double-sized characters may be entered. A combination of both types is also available.
2. Even if the option "Store Name Print by RUBBER STAMP" is selected, data can be programmed for the store name/message. However, the Rubber Stamp, instead of the programmed name/message will actually be printed for operations to issue receipts.
If the option "Store Name Print by DOT PRINTER" is selected, use 1 through 4 for the store name/message and 5 through 7 for the commercial message data, as Line No.
The range Line Nos. 5 to 7 is unavailable to a manual-cut printer.
3. If no commercial message is required on the receipt, program blanks for all three lines. As a result no extra lines will be fed. If any one of the three lines is programmed, the two other lines will cause line feeds.
4. The 4-line range assigned for the store name/message will be either printed or fed, regardless of any system option selection.
5. If any incorrect characters have been programmed, depress the [C] key to clear all the characters on a line and then re-enter characters from the beginning, or end the line with an [ST] and re-program the entire line. The new data will be active.
6. When all the lines have been programmed, do a check by issuing receipt. Only the lines with errors need to be re-programmed; other lines will not be affected.

ex.) To program the following draft as the Store Name/Message and Commercial Message (under the option "Store Name by DOT PRINTER"):

T E C	S T O R E	Line No. 1	Store Name/ Message portion, which can be replaced by a RUBBER STAMP print under the option "Store Name by RUBBER STAMP". Commercial Message portion.
1 3 4 3	P E A C H D R I V E	Line No. 2	
P H O N E :	8 7 - 6 4 3 7	Line No. 3	
		Line No. 4	
O p e n	8 : 0 0 a m t o 7 : 0 0 p m	Line No. 5	
C l o s e d :	e v e r y W e d n e s d a y	Line No. 6	
		Line No. 7	

OPERATION: Presumed that nothing has been programmed on each line.
 Mode Lock: **SET**; enter 1, depress **[X]**.

1 **[ST]** (Line No.1)
[SPACE]
[SPACE]
[SPACE]
[X] T
[X] E
[X] C
[SPACE]
[SPACE]
[X] S
[X] T
[X] O
[X] R
[X] E
[ST] (to complete Line 1)

(2 **[ST]**) (Line No.2)
[SPACE]
[SPACE]
[SPACE]
[SPACE]
 1
 3
 4
 3
[SPACE]
 P
 E
 A
 C
 H
[SPACE]
 D
 R
 I
 V
 E
[ST] (to complete Line 2)

(3 **[ST]**) (Line No. 3)
[SPACE]
[SPACE]
[SPACE]
[SPACE]
[SPACE]
 P
 H
 O
 N
 E
 :
 :
[SPACE]
 8
 7
 -
 6
 4
 3
 7
[ST] (to complete Line 3)

5 **[ST]** (Line No.5)
 O
 p
 e
 n
[SPACE]
 :
[ST] (to complete Line 5)

(6 **[ST]**) (Line No.6)
 C
 l
 o
 s
 e
 d
 :
[ST] (to complete Line 6)

[AT/TL] to complete this
 submode.

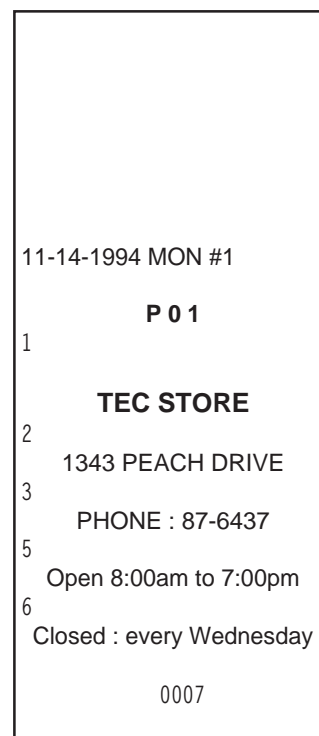

CASHIER CODE AND NAME PROGRAMMING (Submode 2)

Programming

CONDITION Any time outside a sale

OPERATION Mode Lock: SET

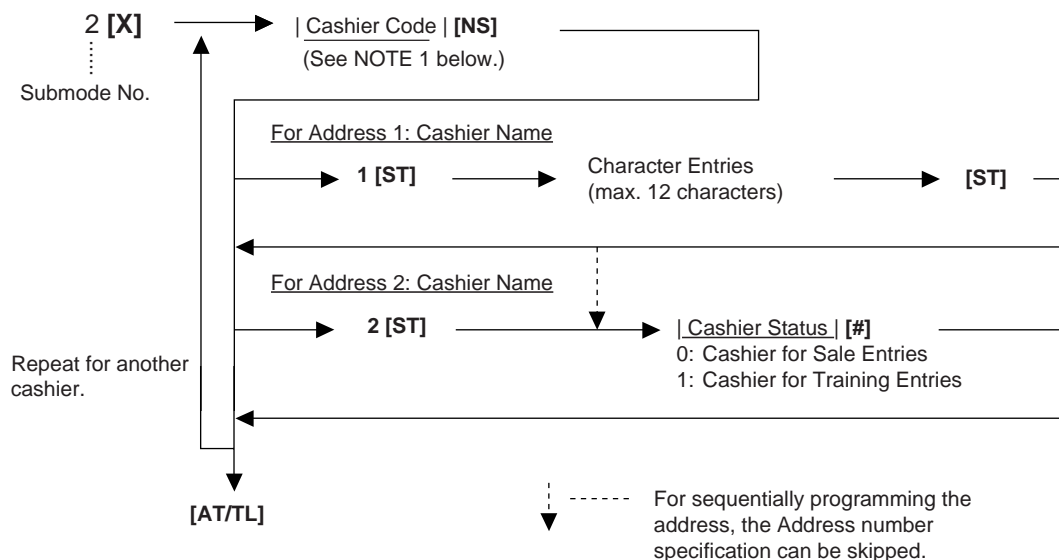

NOTES:

1. The following table shows the Cashier Codes that can be entered. (The capacity is determined by the RAM Allocation Setting.)

Code Entry Type		1 to 10
Cashier Key Type	Push-stay	1 to 4, 99*
	[CLK] key	1 to 8, 99*

* The Cashier Code 99 for the Cashier Key Type is fixed as a code of a cashier for Training Entries.

2. For the name of each cashier, a maximum of 12 regular-sized or 6 double-sized characters can be entered. A combination of both types is also available.
3. When adopting the Push-stay Cashier Key, the cashier key "OFF" status is required for this programming.

ex.) To program the following cashier data:

Cashier Code 1: Name JONES, Status 0 (for Sale Entries)

Cashier Code 2: Name SMITH, Status 0 (for Sale Entries)

Cashier Code 3: Name MEAL, Status 1 (for Training Entries)

Cashier Code 4: Name BROWN, Status 1 (for Training Entries)

Mode Lock: SET

Enter 2, depress [X].

Enter 1, depress [NS] (Cashier Code)

Enter 1, depress [ST] (Address 1: Name)

J

O

N

E

S

Depress [ST] (to end Name setting)

(Enter 2, depress [ST]) (Address 2: Status)

Enter 0, depress [#] (for Sales Entries)

Enter 2, depress [NS] (Cashier Code)

Enter 1, depress [ST] (Address 1: Name)

S

⋮

H

Depress [ST] (to end Name setting)

(Enter 2, depress [ST]) (Address 2: Status)

Enter 0, depress [#] (for Sales Entries)

Enter 3, depress [NS] (Cashier Code)

Enter 1, depress [ST] (Address 1: Name)

M

⋮

L

Depress [ST] (Address 2: Status)

(Enter 2, depress [ST]) (Address 2: Status)

Enter 1, depress [#] (for Training Entries)

Enter 4, depress [NS] (Cashier Code)

Enter 1, depress [ST] (Address 1: Name)

B

⋮

N

Depress [ST] (to end Name setting)

(Enter 2, depress [ST]) (Address 2: Status)

Enter 1, depress [#] (for Training Entries)

Depress [AT/TL] to end this submode.

TEC STORE			
1343 PEACH DRIVE			
PHONE : 87-6437			
Open 8:00am to 7:00pm			
Closed : every Wednesday			
11-14-1994 MON #1			
P 0 2			
01			
#01	JONES		0
#02			
02			
#01	SMITH		0
#02			
03			
#01	MEHL		1
#02			
04			
#01	BROWN		1
#02			
00004			
		0016	

Deletion

CONDITION After the Daily and GT Cashier's Resets, (and his/her Sign OFF for Code Entry Type)

OPERATION Mode Lock: **SET**

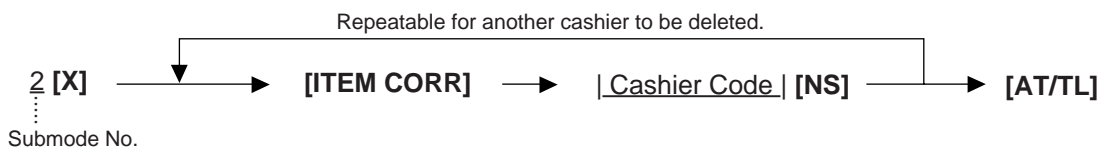

- NOTES:**
1. The Cashier Reset Report Count of the deleted cashier will be cleared.
 2. The cashier key or cashier code of the deleted cashier cannot be used or signed-ON for sale entries.

ex.) To delete Cashier Code 1 with name "JONES" that has been programmed in the preceding page:

Mode Lock: SET

Enter 2, depress [X].

Depress [ITEM CORR] (for declaration of deletion)

Enter 1, depress [NS] (Cashier Code)

Depress [AT/TL] to end this program.

<p>TEC STORE 1343 PEACH DRIVE PHONE : 87-6437 Open 8:00am to 7:00pm Closed : every Wednesday</p> <p>11-14-1994 MON #1</p> <p style="text-align: center;">P 0 2</p> <p>01 JONES</p> <p>-----</p> <p style="text-align: center;">0017</p>

PLU TABLE PROGRAMMING (Submode 4)

This submode can be operated when new PLU items are to be added, PLU program data is to be changed, or PLUs are to be deleted.

Programming or Changing

- CONDITION** To program new PLUs or to change any programmed contents of PLUs except the following case:
 Any time outside a sale
 To change the linked Department of a PLU with sales data not zero: After PLU Reset
- OPERATION** Mode Lock: SET

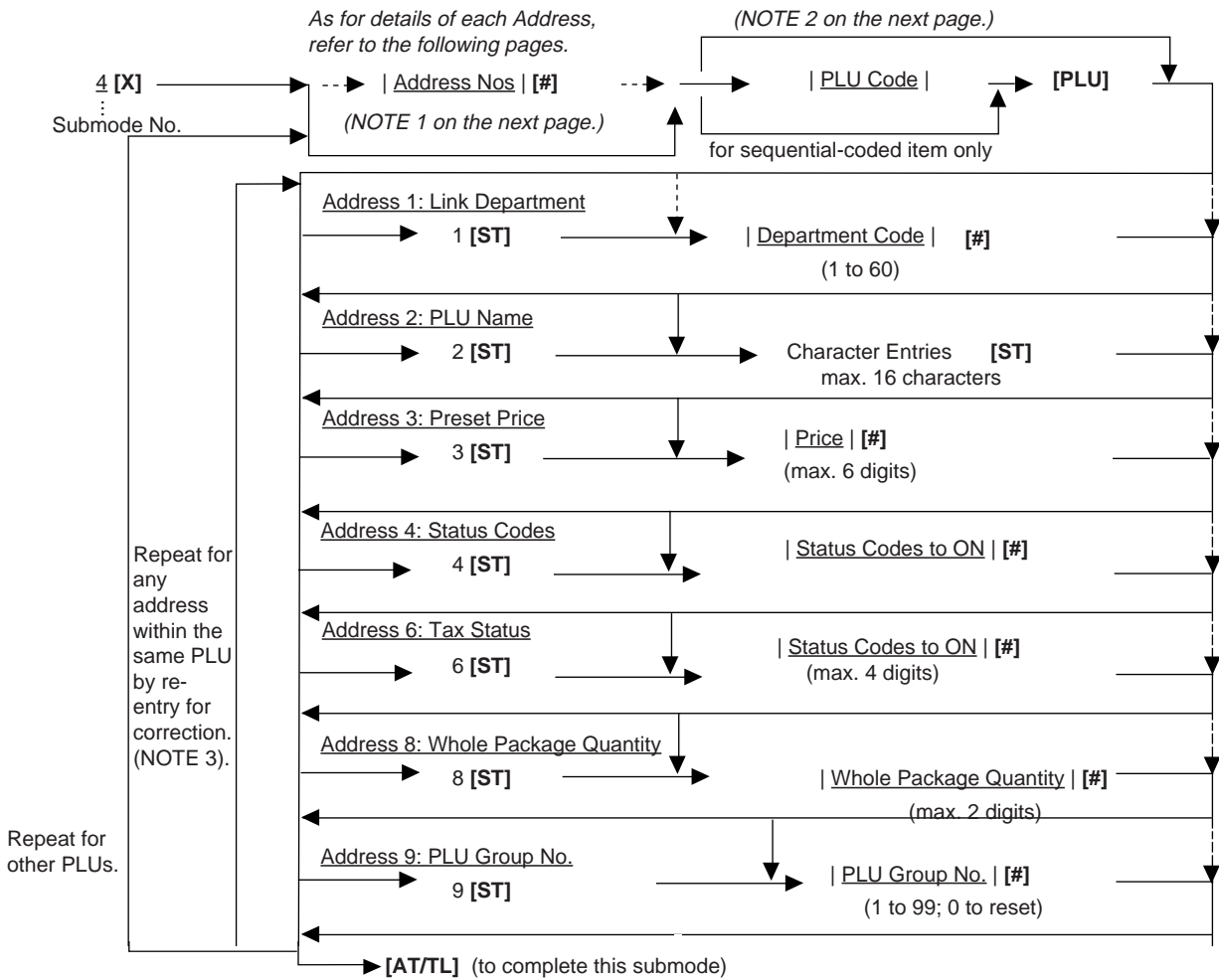

- NOTES:**
- 1) The "Address Nos" designation at the top after "4 [X]" can be skipped if not necessary. If entered, the designated Address (es) will automatically be accessed after the PLU Code designation.
 - 2) A maximum of 1100 PLUs are programmable (varies depending on the allocation of the RAM). The "[PLU]" key here indicates the key labeled simply as "PLU" but not any PLU Preset-code Keys.
 - 3) When the Address No. is sequential from the preceding address (if the Address Designation feature has not been used), the Address No. and the following [ST] can be omitted.
 - 4) The programming contents of each address are further described in the PLU TABLE PROGRAMMING CONTENTS below.

PLU TABLE PROGRAMMING CONTENTS

Address No.	Description of Programming Contents
1	<p><u>Linked Department Code</u> Enter the 2-digit code of the department to which the PLU is linked. When the PLU is newly programmed, this entry is compulsory (an error will result if this entry is skipped.)</p> <p style="text-align: center;"> <input type="text"/> <input type="text"/> [#] 1 to 60 </p>
2	<p><u>Linked Department Code</u> Enter a maximum of 16 regular-sized or 8 double-sized characters. See the CHARACTER ENTRIES at the beginning of this chapter. End with [ST]. When no name is programmed for a PLU, the following will be the auto-program name for printing: PLUxxxxxx (PLU Code Max. 6 digits)</p>
3	<p><u>Preset Price</u></p> <ul style="list-style-type: none"> • For a preset PLU (preset-price PLU, enter a maximum of 6-digit price, and depress [#]. 1 to 999999 (result: \$0.01 to \$9999.99) When the option "Preset Point for one decimal digit allowed" is selected, the decimal digit can be entered after entering a maximum of 5 interger digits and the [•] key 1 to 99999 (result: \$0.01 to \$999.99) or 0.1 to 99999.9 (result: \$0.001 to \$999.999) • A zero-price (\$0.00) may be preset by entering 0 in the above operation. • When no numerics are entered and the [#] key is simply depressed, the PLU will be an open PLU (open-price PLU).

-- Continued on next page --

Address No.	Description of Programming Contents																																						
-- Continued --																																							
4	<p><u>Status 1 Selection</u></p> <ul style="list-style-type: none"> Enter the Status Codes 2 to 8 whose status must be set to ON side. More than one code may be entered. Enter 0 When none of the statuses should be set to ON. <table border="1" data-bbox="517 461 1369 866"> <thead> <tr> <th rowspan="2">Status Code</th> <th rowspan="2">Item</th> <th colspan="2">Selective Status</th> </tr> <tr> <th>OFF</th> <th>ON</th> </tr> </thead> <tbody> <tr> <td>1</td> <td>-- vacant --</td> <td></td> <td></td> </tr> <tr> <td>2</td> <td>Net to S.I. 1?</td> <td>No</td> <td>Yes</td> </tr> <tr> <td>3</td> <td>Net to S.I. 2?</td> <td>No</td> <td>Yes</td> </tr> <tr> <td>4</td> <td>Food Stamp (or GST) Status?</td> <td>No</td> <td>Yes</td> </tr> <tr> <td>5</td> <td>-- vacant --</td> <td></td> <td></td> </tr> <tr> <td>6</td> <td>-- vacant --</td> <td></td> <td></td> </tr> <tr> <td>7</td> <td>Lock or Unlock</td> <td>Unlock (in use)</td> <td>Lock (not in use)</td> </tr> <tr> <td>8</td> <td>Set Menu</td> <td>No</td> <td>Yes</td> </tr> </tbody> </table> <p>NOTES:</p> <ul style="list-style-type: none"> Net to S.I. 1,2 ... Refer to the section of PRESET RATE SETTING FOR SELECTIVE ITEMIZERS near the end of this chapter. <p>Setting Examples: To set only Status 2 to ON ... Enter 2 [#] To set Statuses 2,3,8 to ON ... Enter 238 [#] To set none of statuses to ON ... Enter 0 [#]</p>	Status Code	Item	Selective Status		OFF	ON	1	-- vacant --			2	Net to S.I. 1?	No	Yes	3	Net to S.I. 2?	No	Yes	4	Food Stamp (or GST) Status?	No	Yes	5	-- vacant --			6	-- vacant --			7	Lock or Unlock	Unlock (in use)	Lock (not in use)	8	Set Menu	No	Yes
Status Code	Item			Selective Status																																			
		OFF	ON																																				
1	-- vacant --																																						
2	Net to S.I. 1?	No	Yes																																				
3	Net to S.I. 2?	No	Yes																																				
4	Food Stamp (or GST) Status?	No	Yes																																				
5	-- vacant --																																						
6	-- vacant --																																						
7	Lock or Unlock	Unlock (in use)	Lock (not in use)																																				
8	Set Menu	No	Yes																																				
6	<p><u>Tax Status</u></p> <ul style="list-style-type: none"> Enter one-to four-digit Status Codes for applicable Add-on Tax. <div style="display: flex; align-items: center; margin-left: 40px;"> <div style="border: 1px solid black; width: 20px; height: 20px; display: inline-block; margin-right: 5px;"></div> <div style="border: 1px solid black; width: 20px; height: 20px; display: inline-block; margin-right: 5px;"></div> <div style="border: 1px solid black; width: 20px; height: 20px; display: inline-block; margin-right: 5px;"></div> <div style="border: 1px solid black; width: 20px; height: 20px; display: inline-block; margin-right: 5px;"></div> <div style="margin-left: 5px;">[#]</div> </div> <table border="0" data-bbox="517 1317 1232 1480" style="width: 100%;"> <tr> <td style="width: 50%; vertical-align: top;"> 0: Non-taxable 1: Tax 1 (Tax 1 taxable) 2: Tax 2 (Tax 2 taxable) 3: Tax 3 (Tax 3 taxable) 4: Tax 4 (Tax 4 taxable) </td> <td style="width: 50%; vertical-align: top;"> (More than one code can be entered for combining Tax1 to Tax4 taxable status. For example, enter 12 to select Tax1 and Tax2 taxable status.) </td> </tr> </table>	0: Non-taxable 1: Tax 1 (Tax 1 taxable) 2: Tax 2 (Tax 2 taxable) 3: Tax 3 (Tax 3 taxable) 4: Tax 4 (Tax 4 taxable)	(More than one code can be entered for combining Tax1 to Tax4 taxable status. For example, enter 12 to select Tax1 and Tax2 taxable status.)																																				
0: Non-taxable 1: Tax 1 (Tax 1 taxable) 2: Tax 2 (Tax 2 taxable) 3: Tax 3 (Tax 3 taxable) 4: Tax 4 (Tax 4 taxable)	(More than one code can be entered for combining Tax1 to Tax4 taxable status. For example, enter 12 to select Tax1 and Tax2 taxable status.)																																						
8	<p><u>Whole Package Quantity</u> (for Split Package Pricing PLUs)</p> <div style="display: flex; align-items: center; margin-left: 40px;"> <div style="border: 1px solid black; width: 20px; height: 20px; display: inline-block; margin-right: 5px;"></div> <div style="border: 1px solid black; width: 20px; height: 20px; display: inline-block; margin-right: 5px;"></div> <div style="margin-left: 5px;">[#]</div> </div> <p>Enter the whole package quantity in max. 2 digits (1 to 99), or enter 0 to cancel the Split Package Pricing status.</p> <p>NOTE: • When the option "Preset Point for one decimal digit" is selected, this setting is not allowed to any PLUs.</p>																																						
9	<p><u>PLU Group No.</u> (for purposes of reports)</p> <ul style="list-style-type: none"> Enter a 2-digit code (1 to 99) as a PLU Group No. to which the PLU belongs, and depress [#]. To cancel the Group No. once set, enter 0 and depress [#]. 																																						

ADDITIONAL NOTES

If a PLU is linked to an Other Income Department, the PLU is automatically set as Other Income PLU.

Amount Limits (High Amount, Low Amount) of each open-price PLU will be determined by those of its link department.

ex.) To program the following PLUs:

PLU CODE	Address 1	Address 2	Address 3	Address 4	Address 6	Address 8	Address 9
	Linked Dept. Code	PLU Name	Preset Price	Status ON codes	Tax Status	Whole Package Q'ty	PLU Group No.
10101	1	Tomato	1.00	4	1	6	1
10102	1	Potato	0.80	4	1	6	1
20101	2	Orange	0.75	4	1	4	1
20102	2	Lemon	1.00	4	1	4	1
20105	2	Apple	0.90	4	1	4	1
30301	3	Beef	2.50	45	1		3
30302	3	Pork	2.00	45	1		3
30303	3	Mutton	1.80	45	1		3
40201	4	Salmon	0.75	45	1		2
40202	4	Cod	0.40	45	1		2
40203	4	Shrimp	0.60	45	1		2
50301	5	Milk-Large Pack	1.30	24	1		3
50302	5	Milk-Small Pack	0.40	24	1		3
50303	5	Nonfat-Milk Pack	1.10	24	1		3
50321	5	Cheese-Half Pack	2.50	24	1		3
50322	5	Eggs-6 pack	open	24	1		3
60401	6	White Bread Loaf	1.20	24	1		4
60402	6	Rye Bread Loaf	1.20	24	1		4
60403	6	Soft Rolls-6	0.90	24	1		4
60404	6	Hard Rolls-4	0.80	24	1		4
70501	7	Tuna Can	0.50	24	1		5
70502	7	Soup Can	0.45	24	1		5
80501	8	Strawberry Jam	4.40	24	1	4	5
80502	8	Kiwi Jam	2.20	24	1	2	5
80503	8	Pickles	1.20	24	1		5
90601	9	Coke Small-B	0.60	2	1		6
90701	9	7-up Small-B	0.60	2	1		7
101301	10	Small-Btl Depo	0.50	0	1		13
110501	11	Potato Chips	1.50	2	1		05
120501	12	Nutmeg	0.60	2	1		05

- 1 to 99
- 0: Non-taxable
 - 1: Add-on Tax 1
 - 2: Add-on Tax 2
 - 3: Add-on Tax 3
 - 4: Add-on Tax 4
 - 0: No ON-statuses
 - 1: -- vacant --
 - 2: Net to S.I. 1
 - 3: Net to S.I. 2
 - 4: Food Stamp (or GST) Status
 - 5: -- vacant --
 - 6: -- vacant --
 - 7: Lock (not in use) status
 - 8: Set Menu status

-- KEY OPERATION is on the next page --

KEY OPERATION: for programming some of the PLUs listed on the preceding page.

(Presumed that the following PLUs are newly programmed.)

Mode Lock: **SET**, enter 4, depress **[X]**.

10101 **[PLU]** 1 **[ST]** 1 **[#]** (PLU Code; Linked Dept)
 2 **[ST]** Tomato **[ST]** (Name)
 3 **[ST]** 100 **[#]** (Preset Price / Whole Package)
 4 **[ST]** 4 **[#]** (ON-status Codes: Food Stampable)
 6 **[ST]** 1 **[#]** (Tax 1 taxable)
 8 **[ST]** 6 **[#]** (Whole Package Quantity is 6)
 9 **[ST]** 1 **[#]** (PLU Group No.)

⋮

90601 **[PLU]** 1 **[ST]** 9 **[#]** (PLU Code; Linked Dept)
 2 **[ST]** Coke Small-B **[ST]** (Name)
 3 **[ST]** 60 **[#]** (Preset Price / one-bottle net)
 4 **[ST]** 2 **[#]** (ON-status Codes; Net to S.I. 1)
 6 **[ST]** 1 **[#]** (Tax 1 taxable)
 9 **[ST]** 6 **[#]** (PLU Group No.)

⋮

101301 **[PLU]** 1 **[ST]** 10 **[#]** (PLU Code; Linked Dept)
 2 **[ST]** Small-Btl Depo **[ST]** (Name)
 3 **[ST]** 5 **[#]** (Preset Price / bottle)
 4 **[ST]** 0 **[#]** (ON-status Codes; no ON-statuses)
 6 **[ST]** 1 **[#]** (Tax 1 taxable)
 9 **[ST]** 13 **[#]** (PLU Group No.)

⋮

[AT/TL] to end

TEC STORE
 1343 PEACH DRIVE
 PHONE : 87-6437
 Open 8:00am to 7:00pm
 Closed : every Wednesday

07-14-1994 MON #1

P 0 4

010101
 PLU010101
 #01 01
 #02 Tomato
 #03 1.00@
 #04 4
 #06 1
 #08 6
 #09 01

090601
 PLU090601
 #01 09
 #02 Coke Small-B
 #03 0.60@
 #04 2
 #06 1
 #09 06

101301
 PLU101301
 #01 10
 #02 Small-Btl Depo
 #03 0.05@
 #04 0
 #06 1
 #09 13

00030
 0026

Deletion

CONDITION To delete a PLU with sales data of zero: Any time outside a sale
 To delete a PLU with sales data of not zero: After PLU Reset

OPERATION Mode Lock: **SET**

Individual PLU Deletion

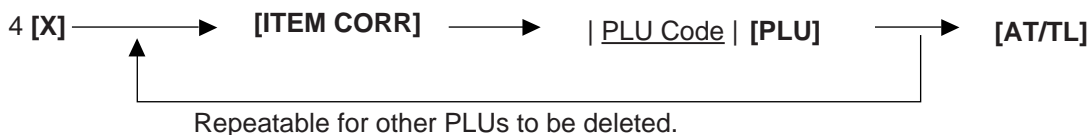

ex.) To delete PLU No. 90701 (7-up Small-B) that was once programmed:

Mode Lock: SET, enter 4, depress **[X]**

[ITEM CORR] 90701 **[PLU]**
[AT/TL]

<p>TEC STORE 1343 PEACH DRIVE PHONE : 87-6437 Open 8:00am to 7:00pm Closed : every Wednesday</p> <p>11-14-1994 MON #1</p> <p>P 0 4</p> <p>090701 7-up Small-B ----- 00029</p> <p>0028</p>
--

All PLU Deletion



PLU Programmed Data Copying

This operation is used to copy the programmed data of a PLU item and to use it in programming another PLU item, thus eliminating time in PLU programming operation.

CONDITION To program new PLUs or to change any programmed contents of PLUs:
 Any time outside a sale (except the following case)
 To change the PLU of the copy-destination with sales data not zero:
 After PLU Reset

OPERATION Mode Lock: SET

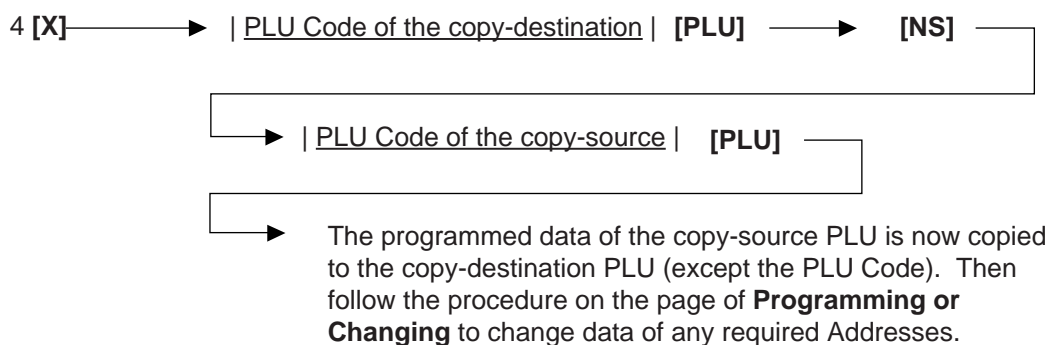

ex.) To program PLU 90701 (7-up Small-B) again that was once programmed and then deleted, by copying the programmed data of PLU 90601 (Coke Small-B):

Mode Lock: SET, enter 4, depress **[X]**

90701 **[PLU]** (PLU Code of the copy-destination)
[NS]
 90601 **[PLU]** (PLU Code of the copy-source)
 2 **[ST]** 7-up Small-B **[ST]**
 (Address 2, Name changed into: 7-up Small-B)
 9 **[ST]** 7 **[#]** (Address 9, PLU Group No. changed into : 7)
[AT/TL] (to end this submode)

<p>TEC STORE 1343 PEACH DRIVE PHONE : 87-6437 Open 8:00am to 7:00pm Closed : every Wednesday</p> <p>11-14-1994 MON #1</p> <p>P 0 4</p> <p>090701 2 #00 090601 #02 7-up Small-B #09 07</p> <p>00030</p> <p>0030</p>
--

TIME SETTING OR ADJUSTMENT (Submode 5)

CONDITION Any time outside a sale

OPERATION Mode Lock: SET

5 [**@/FOR**] → | Hour | | Minute | → [**AT/TL**]
 (0 to 23) (00 to 59)

NOTE: *If an hour value of more than 23 or a minute value of more than 59 is entered, it will result in an error. The current date will not be changed by setting or adjusting the time.*

ex.) To set the time to "1:35 p.m. (13:35)":

Mode Lock to SET, enter 5, depress [**@/FOR**]
 Enter 1335, depress [**AT/TL**].

TEC STORE
 1343 PEACH DRIVE
 PHONE : 87-6437
 Open 8:00am to 7:00pm
 Closed : every Wednesday

11-14-1994 MON #1

P 0 5
 13:35TM

0032

DATE SETTING OR ADJUSTMENT (Submode 6)

CONDITION Any time outside a sale

OPERATION Mode Lock: SET

6 [**@/FOR**] → | Day-of-Week Code | | Month | | Day | | Year | → [**AT/TL**]
 (01 to 12) (01 to 31) (1994, 1995, etc.)

0: SUN (Sunday)
 1: MON (Monday)
 2: TUE (Tuesday)
 3: WED (Wednesday)
 4: THU (Thursday)
 5: FRI (Friday)
 6: SAT (Saturday)

ex.) To set the date to Monday,
 December 19, 1994:

Mode Lock: SET, enter 6, depress [**@/FOR**]

Enter 112191994, depress [**AT/TL**]

TEC STORE
 1343 PEACH DRIVE
 PHONE : 87-6437
 Open 8:00am to 7:00pm
 Closed : every Wednesday

11-14-1994 MON #1

P 0 6
 1 12-19-1994

0032

- NOTES:**
1. The date entry order may be Day-Month-Year or Year-Month-Day instead of Month-Day-Year if so selected in the program option.
 2. The Day-of-week is programmable not to be printed on receipts.

AMOUNT LIMIT SETTING FOR FUNCTION KEYS (Submode 8)

This submode sets the high amount limit in finalizing transactions by tendering through each media key and also sets the high and low amount limits in entering amount through departments.

CONDITION Any time outside a sale

OPERATION Mode Lock: SET

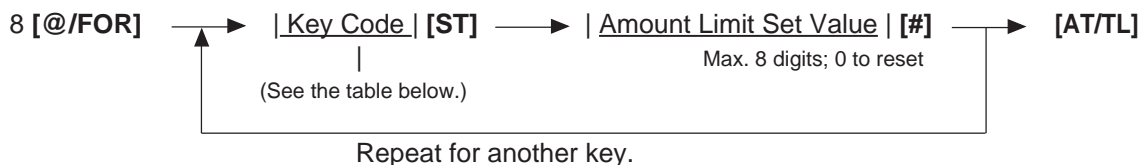

Key code	Item or Key to be applied	Key Code	Item or Key to be applied
1	[AT/TL] (Cash Tender)	7	[CREDIT 2] (Credit 2 Tender)
2	[CHK TEND] (Check Tender)	8	[CREDIT 3] (Credit 3 Tender)
3	[Chg] (Charge Tender)	9	[CREDIT 4] (Credit 4 Tender)
4	[MISC] (Misc. Tender)	10	[FSTL TEND] (Food Stamp Tender)
5	[CPN] (Media-Coupon Tender)	11	Common High Limit for all depts.
6	[CREDIT 1] (Credit 1 Tender)	12	Common Low limit for all depts.

- NOTES:**
1. If the individual High or Low Amount Limit of a department has been set, it prevails over the Common High or Low Limit for all departments here.
 2. The Amount Limit Set Value of each tender media is the high amount limit and is effective only when the media key is used for tendering but not when used as total key.

ex.) To set the Amount Limits of the following items:

Key Code	Amount Limit	Set Value
2 ([CHK TND])	\$99.99	9999
11 (Common High)	\$999.99	100000
12 (Common Low)	\$0.01	1

Mode Lock : SET, 8 [@/FOR]

- 2 **[ST]** (Item Code for Check Media Key)
9999 **[#]**
- 11 **[ST]** 100000 **[#]** (Common High Limit for all depts.)
- 12 **[ST]** 1 **[#]** (Common Low Limit for all depts.)
- [AT/TL]**

TEC STORE
 1343 PEACH DRI-VE
 PHONE : 87-6437
 Open 8:00am to 7:00pm
 Closed : every Wednesday

12-19-1994 MON #1

P 0 8

#02 CHECK	99.99
#11	1000.00
#12	0.01

0037

SALESPERSON CODE AND NAME PROGRAMMING (Submode 20)

By programming Salesperson Codes here, those codes may be used in sales entries. In addition, the name of each salesperson can be programmed in maximum 12 characters.

Programming

CONDITION Any time outside a sale

OPERATION Mode Lock: SET

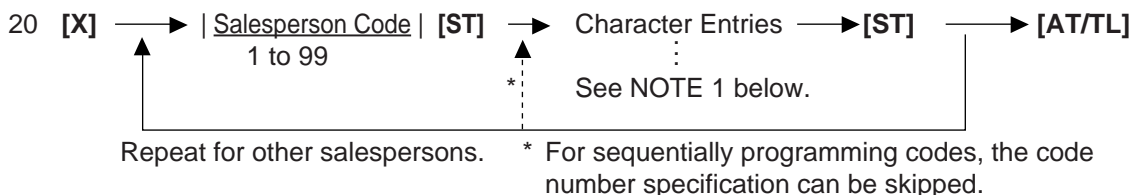

- NOTES:**
1. A maximum of 12 regular-sized or 6 double-sized characters may be programmed for a name. A combination of both types is also available.
 2. Even if no name is programmed (i.e. skipping the Character Entries before the second [ST] key) for a Salesperson Code, that code can be used in sale entries. Then, auto-preset ID symbol "S P xx" (xx = Salesperson Code) will be printed instead of a name on a receipt, etc.

ex.) To program the following Salesperson Codes and names:

Code	Name	Mode Lock: SET
1	White	20 [X]. 1 [ST] (Salesperson Code 1) W h i t e [ST]
2	Stacy	2 [ST] (Salesperson Code 2) S t a c y [ST]
3	Jansen	3 [ST] (Salesperson Code 3) J a n s e n [ST]
		[AT/TL]

TEC STORE
 1343 PEACH DRIVE
 PHONE : 87-6437
 Open 8:00am to 7:00pm
 Closed : every Wednesday

12-19-1994 MON #1

P 2 0

01 White
 02 Stacy
 03 Jansen

0047

Deletion

CONDITION After Daily Salesperson Reset

OPERATION Mode Lock: SET

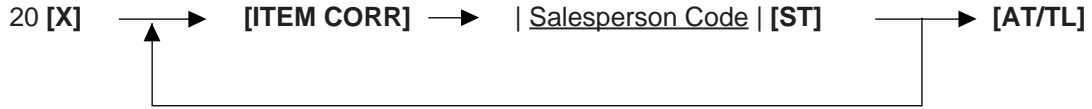

Repeat for other salespersons to be deleted.

NOTE: When a Salesperson Code is deleted in the above operation, no entries using that code will be accepted until the code is again opened in the "Programming" operation already described.

ex.) To delete Salesperson Code 3 (name: Jansen) that was once programmed:

Mode Lock: SET, 20 [X]

[ITEM CORR] 3 [ST]

[AT/TL]

<p>TEC STORE 1343 PEACH DRIVE PHONE : 87-6437 Open 8:00am to 7:00pm Closed : every Wednesday</p> <p>12-19-1994 MON #1</p> <p>P 2 0 03 Jansen ----- 0048</p>
--

PLU PRESET-CODE KEY SETTING (Submode 27)

When there are any keys programmed as PLU Preset-code Keys on the ECR Keyboard, and/or when the PLU Keyboard PK-2 (hardware option) is connected to the ECR, a PLU code may be preset to each of those keys in this operation.

- CONDITION** Any time outside a sale
- OPERATION** Mode Lock: SET

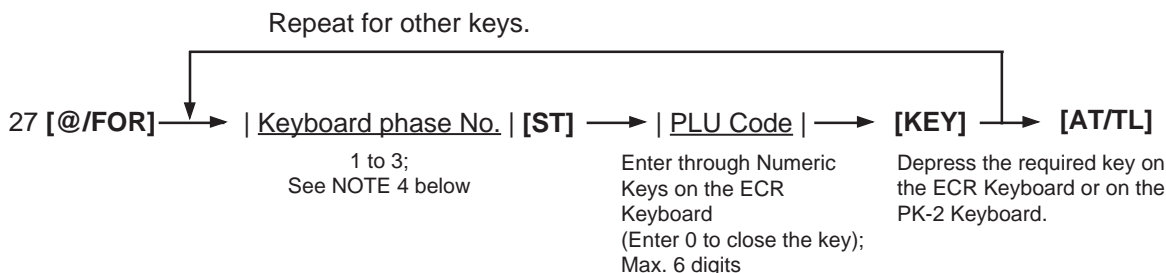

- NOTES:**
1. If the PLU Code entry is skipped and a **[KEY]** is simply depressed in the above sequence, the preprogrammed PLU Code of the KEY will be displayed.
 2. A non-opened PLU Code (i.e. PLU non-existent in the PLU table file can be set on a KEY, however, pressing the KEY in sale entries will result in an error unless the code is opened in the PLU TABLE PROGRAMMING operation. Submode 4.
 3. If "0" is entered as PLU Code in the above sequence, the KEY will be closed. Pressing the closed KEY in sale entry will cause an error.
 4. The designation of the keyboard phase No. is omissible. In this case, the PLU code is automatically programmed on the keyboard phase No. 1. This designation is unavailable to the PK-2.

ex.) To set the following PLU Codes to KEYS on the ECR keyboard:

PLU Code

50321
50322

Mode Lock to SET.

27 [@/FOR]

50321 [required key]
50322 [required key]

[AT/TL]

Location Code (left side): refer to REMARKS 1 and 2 on the next page. →
PLU Code assigned to the key (right side)

TEC STORE
1343 PEACH DRIVE
PHONE : 87-6437
Open 8:00am to 7:00pm
Closed : every Wednesday

12-19-1994 MON #1

P 27

#073	050321
#074	050322
0017	

PK-2 KEYBOARD

1	11	21	31	41	51	61	71	81	91	101	111	121
2	12	22	32	42	52	62	72	82	92	102	112	122
3	13	23	33	43	53	63	73	83	93	103	113	123
4	14	24	34	44	54	64	74	84	94	104	114	124
5	15	25	35	45	55	65	75	85	95	105	115	125
6	16	26	36	46	56	66	76	86	96	106	116	126
7	17	27	37	47	57	67	77	87	97	107	117	127
8	18	28	38	48	58	68	78	88	98	108	118	128
9	19	29	39	49	59	69	79	89	99	109	119	129
10	20	30	40	50	60	70	80	90	100	110	120	130

NOTES:

1. The Nos 1 through 130 marked on the PK-2 Keyboard are the KEY Nos to be printed on the left side of the program receipt issued in the operation on the preceding page. If each KEY is not set with a PLU Code, the auto-preset PLU Code identical to the initial KEY No. in the above figure will be active as its preset PLU Code.
 ex.) KEY No. 1 PLU Code 1
 KEY No. 130 PLU Code 130
2. When a PLU code is assigned to a PLU Preset-code Key on the ECR Keyboard in the operation on the preceding page, the Hardware Key Code which indicates the absolute location of the key will be printed to the left of the assigned PLU Code. The Hardware Key Codes of the ECR keyboard are shown below.

ECR Flat Type Keyboard

1	8	15	22	29	36	43	50	57	64	71	78	85	92	99	104	110	117	124	129	136	139	
2	9	16	23	30	37	44	51	58	65	72	79	86	93	100	105	111	118	125	130	137	140	
3	10	17	24	31	38	45	52	59	66	73	80	87	94		112	119	126	131	138	141		
4	11	18	25	32	39	46	53	60	67	74	81	88	95	101	106	113	120	127	132	142		
5	12	19	26	33	40	47	54	61	68	75	82	89	96	102	107	114	121		133	143		
6	13	20	27	34	41	48	55	62	69	76	83	90	97	103	108	115	122	128	134	144		
7	14	21	28	35	42	49	56	63	70	77	84	91	98		109	116	123		135	145		

NEGATIVE AMOUNT KEY LIMIT AMOUNT SETTING (Submode 35)

This submode sets the limit amount to be entered through each of the negative-amount keys [VND CPN], [STR CPN], [BTL RTN], and [DOLL DISC].

CONDITION Any time outside a sale

OPERATION Mode Lock: SET

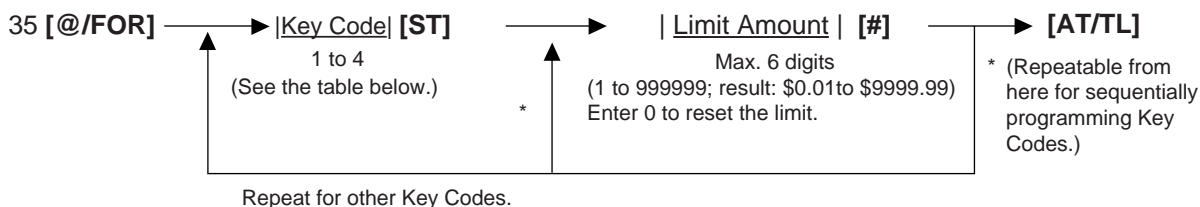

KEY CODE AND KEY TABLE

Key Code	Key
1	[VND CPN]
2	[STR CPN]
3	[BTL RTN]
4	[DOLL DISC]

- NOTES:**
- The respective keys will not be restricted by the limit amount set here but the amount up to 7 digits will be entered in MGR or mode.
 - The limit set here cannot be released by the [LC OPEN] (or [OPEN]) key in transaction entries.

ex.) To set High Limit Amounts for the respective keys below:

Key	Key Code	High Limit
[VND CPN]	1	\$10.00
[STR CPN]	2	\$20.00
[BTL RTN]	3	\$1.20
[DOLL DISC]	4	\$1.00

Mode Lock: SET
35 [@/FOR]

1 [ST] 1000 [#]
2 [ST] 2000 [#]
3 [ST] 120 [#]
4 [ST] 100 [#]

[AT/TL]

TEC STORE
1343 PEACH DRIVE
PHONE : 87-6437
Open 8:00am to 7:00pm
Closed : every Wednesday

12-19-1994 MON #1

P 3 5

V. CPN	\$10.00
S. CPN	\$20.00
BTR	\$1.20
DISC	\$1.00

0066

SET MENU TABLE PROGRAMMING (Submode 42)

This submode creates the set menu tables for PLUs with set menu status programmed in PLU TABLE PROGRAMMING (Submode No. 4). By entering the PLU programmed as a set menu PLU (main menu) in this programming, the sub-menu items are entered automatically.

CONDITION Any time outside a sale

OPERATION Mode Lock: SET

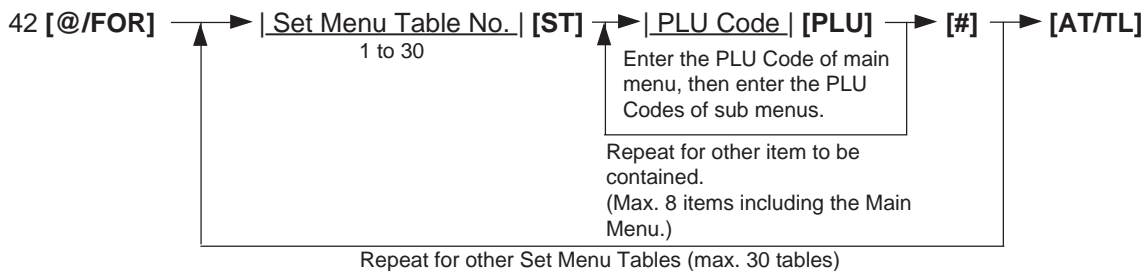

NOTE: The main menu is also available with an open PLU.

ex.) To set the following Set Menu:

Table No.1

- Main Menu PLU No. 5 (BEEF STK SET)
- Sub Menu PLU No.30 (VEGET. SALAD)
- Sub Menu PLU No.40 (CORN SOUP)
- Sub Menu PLU No.50 (COFFEE)

Mode Lock to SET, 42 [*/FOR] 1 [ST] 5 [PLU] 30 [PLU] 40 [PLU] 50 [PLU] [#] [AT/TL]

TEC STORE
 1343 PEACH DRIVE
 PHONE : 87-6437
 Open 8:00am to 7:00pm
 Closed : every Wednesday

12-19-1994 MON #1

P 4 2

#01	000005				
				000030	
				000040	
				000050	
					0103

DEPARTMENT PRESET PRICE SETTING OR CHANGING

A price of each department may be set or changed by this operation.

CONDITION Any time outside a sale

OPERATION Mode Lock: SET

Repeatable for other departments.

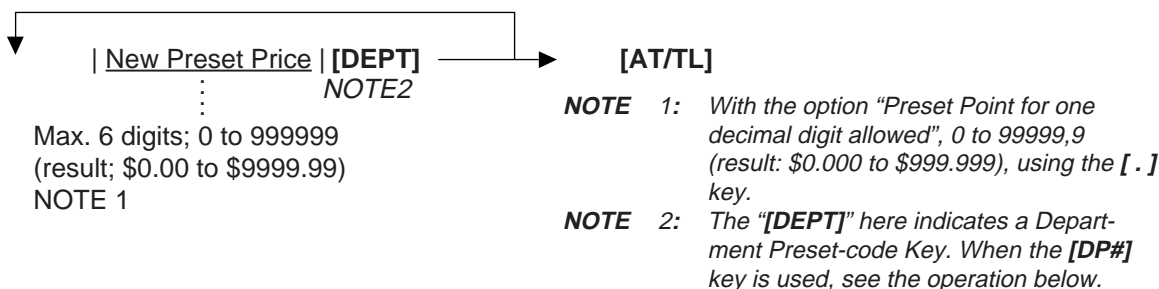

Using the [DP#] Key:

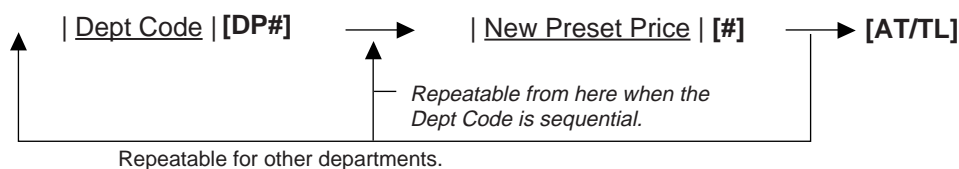

To change a preset-price department into an open department, skip the "New Preset Price" entry and simply depress the [DEPT] key (in the first operation pattern) or simply depress the [#] key (in the second operation pattern). Presetting a zero-price is also possible.

ex.) To set the following preset prices of departments:

Dept. 13 \$1.40
Dept. 14 \$2.10

OPERATION

Mode Lock: SET

By the first operation pattern:

140 **[DEPT 13]**
210 **[DEPT 14]**

By the second operation pattern:

13 **[DP#]** 140 **[#]**
(14 **[DP#]**) 210 **[#]**

[AT/TL]

TEC STORE	
1343 PEACH DRIVE	
PHONE : 87-6437	
Open 8:00am to 7:00pm	
Closed : every Wednesday	
12-19-1994 MON #1	
P 0 0	
13	D P 13 1.40@
14	D P 14 2.10@
0083	

PLU PRESET PRICE SETTING OR CHANGING, WHOLE PACKAGE QUANTITY CHANGING

The preset price of each PLU may be set in the PLU TABLE PROGRAMMING (Submode 4) already described. However, in setting or changing the price only but not other programmed data, the following operation will be more convenient.

CONDITION Any time outside a sale

OPERATION Mode Lock: SET

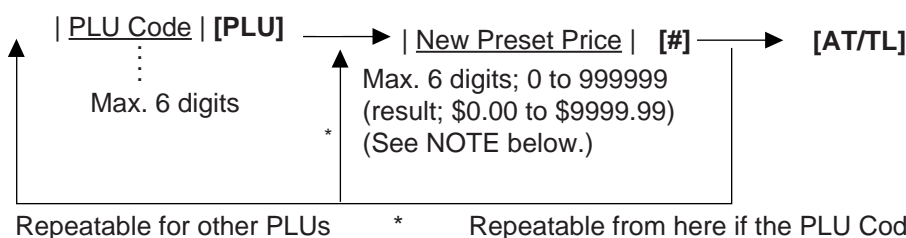

NOTE: With the option "Preset Point for one decimal digit allowed", 0 to 99999.9 (result: \$0.000 to \$999.999) using the [.] key.

To change a preset-price PLU into an open-price PLU, skip the "New Preset Price" entry and simply depress the [#] key. Presetting a zero-price is also possible.

ex.) To set the following preset price of PLUs:

	<u>Old Price</u>	<u>New Price</u>
PLU 110501 (Potato Chips)	\$1.50	\$1.55
PLU 120501 (Nutmeg)	\$0.60	\$0.65

OPERATION

Mode Lock: SET

110501 [PLU] 155 [#]
120501 [PLU] 65 [#]

[AT/TL]

TEC STORE
1343 PEACH DRIVE
PHONE : 87-6437
Open 8:00am to 7:00pm
Closed : every Wednesday

12-19-1994 MON #1

P 0 0

110501	
Potato Chips	1.55@
120501	
Nutmeg	0.65@

0086

Setting or Changing Preset Price of Split Package Pricing PLU

CONDITION Any time outside a sale

OPERATION Mode Lock: SET

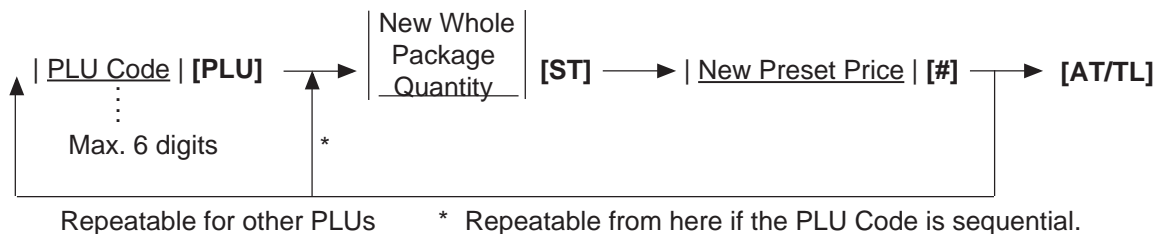

ex.) To set the following preset price of PLUs:

	<u>New Whole Package Q'ty</u>	<u>New Preset Price</u>
PLU 20105 (Apple)	6	\$1.25

OPERATION

Mode Lock: SET

20105 [PLU] 6 [ST] 125 [#]

[AT/TL]

TEC STORE
 1343 PEACH DRIVE
 PHONE : 87-6437
 Open 8:00am to 7:00pm
 Closed : every Wednesday

12-19-1994 MON #1

P 0 0

020105	/	6
Apple		1.25@

0088

%+ AND %- PRESET RATE SETTING

A preset rate may be set on each of the [%+] and [%-] keys, one independent rate for each key. Once a rate is preset, the % key will simply be depressed without a prior rate entry to activate the preset rate. If a rate is entered prior to the depression of the key, the entered rate (manual rate) will be activated instead.

CONDITION Any time outside a sale

OPERATION Mode Lock: SET

| Preset Rate | [% +] (For Percent Charge Preset Rate)

(0.001 to 99.999 (%); use the [.] key if a decimal portion is contained.)

| Preset Rate | [% -] (For Percent Discount Preset Rate)

ex.) To set 10% on [%+] key:

Mode Lock: SET, enter 10, depress [%+]

ex.) To set 5% on [%-] Key;

Mode Lock: SET, enter 5, depress [%-].

To reset the rate once set:

Enter 0, depress the required % key.

(Then the % key will always require a manual rate entry in sale entries.)

NOTE: When two [%+] keys or two [%-] keys are installed on the keyboard, two different % rates (one for each) may be preset, in the same manner as described above. The two rates may be the same or different from the other. Or only one key may be preset with a rate and other may remain non-preset.

TEC STORE		
1343 PEACH DRIVE		
PHONE : 87-6437		
Open 8:00am to 7:00pm		
Closed : every Wednesday		
12-19-1994 MON #1		
13	P 0 0	10%
%		
0037		
Op		
Closed : every wednesday		
12-19-1994 MON #1		
%	P 0 0	5%
0038		

PRESET RATE SETTING FOR SELECTIVE ITEMIZERS (SI1 and SI2)

If any of **[ST1/TL]** (or **[SI/TL]**) and **[SI2/TL]** keys are installed on the keyboard, a preset rate may be programmed on each key.

As for the functions and applications of the Selective Itemizers, refer to the description on the next page.

- CONDITION** Any time outside a sale
- OPERATION** Mode Lock: SET

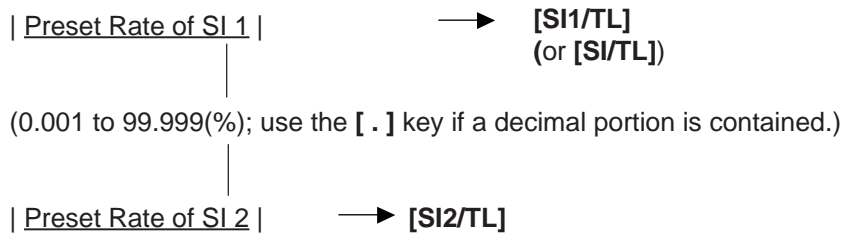

- NOTES:**
1. *Whether the calculated amount by the preset SI %-rate affects (i.e. add to or subtract from) the sale total is determined by a system option status selection.*
 2. *To reset the rate once set, enter 0 as the rate. Then the rate is regarded as 100% if the option "Non-affect" is selected. With the option "SI Affects Sale Total", some rate other than "0" should be programmed.)*

ex.) To set 7% as SI1 preset % rate:
 Mode Lock: SET
 7 **[ST1/TL]**.

TEC STORE
 1343 PEACH DRIVE
 PHONE : 87-6437
 Open 8:00am to 7:00pm
 Closed : every Wednesday

12-19-1994 MON #1

P 0 0

SI 1TL 7%

0043

Selective Itemizer Functions and Applications

The "Selective Itemizer" is a temporary total memory for each sale and is activated separately from the Main Itemizer (i.e. sale total memory). If certain Department or PLU items are programmed with the SI (selective itemizer) "net" status, the Selective Itemizer will function to add up amounts of the SI-net status items in registering the items, while the Main Itemizer will function to add up all the items in the sale. Thus, near the sale finalization, the operator may read the SI content by depressing the **[SI/TL]** key.

A preset % rate may be programmed for each of SI1 and SI2 (on the preceding page), and whether the calculated amount will add to, subtract from, or non-affect the sale total is a selective option. Whether the amount resulted by depressing the **[SI/TL]** key will print or non-print is another selective option.

The applications of this function may vary from store to store. Some stores may use it for counting the service stamps to be issued to the customers according to the sale amount of service-stampable items. In this case, the option "SI Total Non-affects Sale Total" should be selected, and a preset % rate, 1% for example, may be set to issue one service stamp for every \$1.00. Thus the number of stamps to be issued to the customer is displayed (and printed if so programmed) as a result of calculation with the preset % rate, but the resulted value (the number of stamps in this case) will not affect the sale total.

Example 1) With option "SI Total Non-affects Sale Total":

Key Operation in REG Mode

100 **[DEPT 1]** (SI-net)
 150 **[DEPT 2]** (non-SI)
 200 **[DEPT 3]** (SI-net)
[SI/TL] (1% is preset)
[AT/TL]

Receipt/Journal Print

DP 01	1.00 S
DP 02	1.50
DP 03	2.00 S
SI TL	0.03
CASH	4.50

"S": SI-net Symbol

Number of stamps to be issued.

Dept.1 and Dept. 3 are programmed with SI-net-status. On depressing **[SI/TL]**, "0.03" (which is 1 % of total amount of Dept. 1 "1.00" + Dept. 3 "2.00") is displayed and printed, and 3 stamps are to be issued to the customer in this case.

The sale total "4.50" is not affected by the SI calculation.

Other stores may use it for calculating the discount amount for certain sales items during a special discount sales period by presetting the discount % rate on the SI and programming SI-net status to certain Departments and PLUs which are subject to the special discount.

Example 2) With option "SI Special Discount":

Key Operation in REG Mode

100 **[DEPT 1]** (SI-net)
 150 **[DEPT 2]** (non-SI)
 200 **[DEPT 3]** (SI-net)
[SI/TL] (10% is preset)
[AT/TL]

Receipt/Journal Print

DP 01	1.00 S
DP 02	1.50
DP 03	2.00 S
SI TL	-0.30
CASH	4.20

Discount Amount resulted by SI %

On depressing **[SI/TL]**, "-0.30" (which is 10% discount from the total amount of Dept.1 + Dept. 3 items) is displayed and printed, and that amount is subtracted from the sale total. ($4.50 - 0.30 = 4.20$)

FOREIGN CURRENCY EXCHANGE RATE SETTING

In this program, the rate of each foreign currencies (corresponding to the [CUR1] to [CUR5] keys) will be set. By setting a rate on each Foreign Currency Key, reading the sale total and tendering in the foreign currency value will be possible for sale finalization.

CONDITION Any time outside a sale

OPERATION Mode Lock: SET

| Exchange Rate for Foreign Currency 1 | —▶ [CUR1]
 0.000001 to 9999.99999
 (Use the [.] key if decimal portion is contained in the rate.)

⋮

| Exchange Rate for Foreign Currency 5 | —▶ [CUR5]

As for how to calculate the Exchange Rate, see the description below.

Foreign Currency Exchange Rate Calculation

1. The rate must be calculated in the subsidiary currency unit values for both the domestic and the foreign currencies. (In calculating the rate from the domestic to a foreign currency with the same zero-suppress form, such as from U.S. \$ to French Franc. it will be no problem even if it is calculated in the main currency of \$ and Franc. However, in case of exchanging from a domestic currency such as \$ or Franc to Japanese yen or Italian Lira, or vice versa, this rule must be obeyed; otherwise a wrong rate will result.)
2. Calculate the required foreign currency value equivalent to the domestic currency value "1". Then the obtained value is the Exchange Rate value to be entered in the setting operation stated above.

For example, if the domestic currency is U.S. \$:

1¢ = xxxx.xxxxxx centimes (French Franc)
 = xxxx.xxxxxx pfennings (Deutsche Mark)
 = xxxx.xxxxxx yen (Japaneses yen)

etc.



Enter this value as each foreign currency rate.

ex.) To set three foreign currency rates:

Domestic Currency U.S. \$
 Assigning: **[CUR 1]** French Franc
[CUR 2] Deutsche Mark
[CUR 3] Japanese yen

Conditions given for Domestic Currency and Foreign Currencies
 (The rates here are merely examples.)

(DOMESTIC)		(CUR1)		(CUR2)		(CUR3)	
U.S. Dollar		French Franc		Deutsche Mark		Japanese Yen	
↓		↓		↓		↓	
\$1.00	=	F5.3729	=	DM1.7619	=	(145.50) ...	In Main Currency Values
↓		↓		↓		↓	
1 cent	=	5.3729 centimes	=	1.7619 pfennigs	=	1.4550 yen	In Subsidiary Currency Values (Enter these values for setting.)

KEY OPERATION for setting the rates above:

Mode Lock: SET

5 [.] 3729 **[CUR1]** (for French Franc)
 1 [.] 7619 **[CUR2]** (for Deutsche Mark)
 1 [.] 4550 **[CUR3]** (for Japanese yen)

Resetting a Foreign Currency Rate Once Set:

Enter "0" in place of the Exchange Rate for the Foreign Currency in the setting operation. Then the rate for that foreign currency will be reset. The Foreign Currency Key of the rate thus reset cannot be used in sales entries.

TEC STORE
 1343 PEACH DRIVE
 PHONE : 87-6437
 Open 8:00am to 7:00pm
 Closed : every Wednesday

12-19-1994 MON #1

P 0 0

CUR1 5.3729 *

0046

Closed : every Wednesday

12-19-1994 MON #1

P 0 0

CUR2 1.7619 *

0047

Closed : every Wednesday

12-19-1994 MON #1

P 0 0

CUR3 1.455 *

0048

TAX TABLE PROGRAMMING

A maximum of four tables can be programmed (Tax 1, Tax 2, Tax 3, Tax 4) in accordance with installation of [TX1/M], [TX2/M], [TX3/M], [TX4/M] keys.

CONDITION After Financial Daily Reset

OPERATION Mode Lock: SET

TYPE 1: TAX 1 FULL BREAKS (COMBINATION OF NON-CYCLIC AND CYCLIC BREAKS)

| Max. amount non-taxable | [TX1/M]

| Max. amount for 1¢ tax levied | [TX1/M]

| Max. amount for 2¢ tax levied | [TX1/M]

⋮

Repeat up to the "A" Break

⋮

| Max. amount for N¢ tax levied | ... "A" Break (Non-cyclic Break Limit)

[ST] (to indicate the completion of Non-cyclic Breaks)

⋮

| Max. amount for N + 1¢ tax levied | [TX1/M] (beginning of Cyclic Breaks)

| Max. amount for N + 2¢ tax levied | [TX1/M]

⋮

Repeat up to the "B" Break ("B" Break - "A" Break = Multiple of \$1.00; max. \$9.00)

[AT/TL] (to complete this tax table programming)

NOTE: The break amount entry must be a maximum of 4 digits (1 to 9999 resulting in \$0.01 to \$99.99)

TYPE2: TAX 1 COMBINATION OF NON-CYCLIC BREAKS AND % RATE

First set the breaks up to the "A" Break entry and the [ST] key depression as shown in TYPE 1.

↓

| TAX RATE applied when exceeding the "A" Break amount |

(0.0001 to 99.9999 (%); use the [.] key if a decimal portion is contained. Examples: To set 5% , enter 5. To set 5.26%, enter 5.26. The fraction of the amount resulting from this % rate calculation will be rounded off.)

↓

[AT/TL] (to complete this tax table programming)

TYPE3: TAX 1% RATE ONLY

0 [TM1/M] → [ST] → | TAX RATE | → [AT/TL]

⋮

(The description for the TAX RATE in TYPE 2 is also applied to this case.)

- NOTES:**
1. For Tax 2, Tax 3, Tax 4 table programming, follow the same procedure in TYPE1,2, or 3 on the preceding page, using [TX2/M] or [TX3/M] or [TX4/M] instead of [TX1/M].
 2. If multiple tax tables are programmed, the Tax 1 table must be set first, then Tax 2, Tax 3 and Tax 4. The Tax 1 table setting will automatically reset all of the old Tax 1,2,3 and 4 tables if they have been programmed.
 3. No second depression of the [ST] key is allowed within one tax table programming.
 4. A maximum of 99 breaks can be entered for Tax 1 to Tax 4 tables altogether.

ex. 1) TAX 1 FULL BREAKS

<u>Tax Table</u>	
<u>Amount Renge</u>	<u>Tax Levied</u>
\$0.00 to \$ 0.10	0¢
\$0.11 to \$ 0.22	1¢
\$0.23 to \$0.39	2¢
\$0.40 to \$0.56	3¢
\$0.57 to \$0.73	4¢
\$0.74 to \$0.90	5¢
\$0.91 to \$1.08	6¢
..... "A" Break	
\$1.09 to \$1.24	7¢
\$1.25 to \$1.41	8¢
\$1.42 to \$1.58	9¢
\$1.59 to \$1.74	10¢
\$1.75 to \$1.92	11¢
\$1.92 to \$2.08	12¢
..... "B" Break	

<u>Key Operation</u>	
Mode Lock: SET	
10	[TX1/M]
22	[TX1/M]
39	[TX1/M]
56	[TX1/M]
73	[TX1/M]
90	[TX1/M]
108	[TX1/M]
	[ST]
124	[TX1/M]
141	[TX1/M]
158	[TX1/M]
174	[TX1/M]
192	[TX1/M]
208	[TX1/M]
	[AT/TL]

TEC STORE
 1343 PEACH DRIVE
 PHONE : 87-6437
 Open 8:00am to 7:00pm
 Closed : every Wednesday

12-19-1994 MON #1

P 0 0

TAX1	
00	\$0.10
01	\$0.22
02	\$0.39
03	\$0.56
04	\$0.73
05	\$0.90
06	\$1.08
*	
07	\$1.24
08	\$1.41
09	\$1.58
10	\$1.74
11	\$1.92
02	\$2.08
**	

0058

ex. 2) TAX 2 COMBINATION OF NON-CYCLIC BREAKS AND % RATE

Tax Table

<u>Amount Renge</u>	<u>Tax Levied</u>
\$0.00 to \$ 0.09	0¢
\$0.10 to \$ 0.29	1¢
\$0.30 to \$0.59	2¢
\$0.60 to \$0.84	3¢
\$0.85 to \$1.12	4¢
.... "A" Break	

5% is applied to any amount exceeding the "A" Break.

Key Operation

Mode Lock: SET

9	[TX2/M]
29	[TX2/M]
59	[TX2/M]
84	[TX2/M]
112	[TX2/M]
	[ST]
5	[AT/TL]

TEC STORE
 1343 PEACH DRIVE
 PHONE : 87-6437
 Open 8:00am to 7:00pm
 Closed : every Wednesday

12-19-1994 MON #1

P 0 0

TAX2	
00	\$0.09
01	\$0.29
02	\$0.59
03	\$0.84
04	\$1.12
*	5%

0064

ex. 3) TAX 3% RATE ONLY

Tax Table

10% is applied to any sale amount.

Key Operation

Mode Lock: SET

0	[TX3/M]
	[ST]
10	[AT/TL]

TEC STORE
 1343 PEACH DRIVE
 PHONE : 87-6437
 Open 8:00am to 7:00pm
 Closed : every Wednesday

12-19-1994 MON #1

P 0 0

TAX3	
00	\$0.00
*	10%

0065

GST RATE SETTING

This operation sets the rate of GST (Goods and Service Tax) in CANADA.

CONDITION Any time outside a sale

OPERATION Mode Lock: SET

| GST Rate | → **[GST/M]**
 ⋮
 0.01 to 99.99 (%)
 (Use the [.] key if the decimal portion is contained.)

To reset the rate once set:

Mode Lock: SET

Enter 0, depress the **[GST/M]**

ex.)To set the GST rate to 12%:

OPERATION

Mode Lock: SET

12 **[GST/M]**

TEC STORE		
1343 PEACH DRIVE		
PHONE : 87-6437		
Open 8:00am to 7:00pm		
Closed : every Wednesday		
12-19-1994 MON #1		
P 0 0		
GST		12%
0069		

STORE/REGISTER NO. SETTING

A maximum of 6 digits may be set as ID No. for the store and/or register. And once set, it will be printed on every receipt and every transaction on journal.

CONDITION Any time outside a sale

OPERATION Mode Lock: SET

| Store/Register No. | → [#]
 ⋮
 Max. 6 digits; 0 to 999999

NOTE *The preceding zeros, if entered, will not be printed. For example, if "001234" is entered in the above operation. "#1234" will always be printed as the Register No.*

ex.) To set the following:

Register No. of this terminal: 3001

OPERATION

Mode Lock: SET

3001 [#]

<p style="text-align: center;">TEC STORE 1343 PEACH DRIVE PHONE : 87-6437 Open 8:00am to 7:00pm Closed : every Wednesday</p> <p>12-19-1994 MON #1</p> <p style="text-align: center;">P 0 0</p> <p style="text-align: right;">#3001</p> <p style="text-align: center;">0071</p>
--

