

SHARP®

ELECTRONIC CASH REGISTER
CAJA REGISTRADORA ELECTRONICA

MODEL
MODELO **XE-A20S**

INSTRUCTION MANUAL

MANUAL DE INSTRUCCIONES



WARNING

FCC Regulations state that any unauthorized changes or modifications to this equipment not expressly approved by the manufacturer could void the user's authority to operate this equipment.

Note: This equipment has been tested and found to comply with the limits for a Class A digital device, pursuant to Part 15 of the FCC Rules. These limits are designed to provide reasonable protection against harmful interference when this equipment is operated in a commercial environment.

This equipment generates, uses, and can radiate radio frequency energy and, if not installed and used in accordance with the instruction manual, may cause harmful interference to radio communications. Operation of this equipment in a residential area is likely to cause harmful interference in which case the user will be required to correct the interference at his own expense.

CAUTION

The AC power socket-outlet should be installed near the equipment and should be easily accessible.

FOR YOUR RECORDS

Please record below the model number and serial number for easy reference in case of loss or theft. These numbers are located on the right side of the unit. Space is provided for further pertinent data.

Model Number _____

Serial Number _____

Date of Purchase _____

Place of Purchase _____

INTRODUCTION

Thank you very much for your purchase of the SHARP Electronic Cash Register, Model XE-A20S. Please read this manual carefully before operating your machine in order to gain full understanding of functions and features. Please keep this manual for future reference. It will help you if you encounter any operational problems.

CAUTION!

Never install the batteries into the cash register before initializing it. Before you start operating the cash register, you must first initialize it, then install the batteries. Otherwise, distorted memory contents and malfunction of the cash register will occur. For this procedure, please refer to [page 7](#).

IMPORTANT

- **On the printer, a cutter to cut the paper roll is mounted. Always be careful not to cut yourself by the cutter.**
- **Install your register in a location that is not subject to direct radiation, unusual temperature changes, high humidity or exposed to water sources.**
Installation in such locations could cause damage to the cabinet and the electronic components.
- **Never operate the register with wet hands.**
The water could seep into the interior of the register and cause component failure.
- **When cleaning your register, use a dry, soft cloth. Never use solvents, such as benzine and/or thinner.**
The use of such chemicals will lead to discoloration or deterioration of the cabinet.
- **The register plugs into any standard wall outlet (120V AC $\pm 10\%$).**
Other electrical devices on the same electrical circuit could cause the register to malfunction.
- **For protection against data loss, please install three “AA” batteries after initializing the cash register. When handling the batteries, never fail to observe the followings:**
Incorrectly using batteries can cause them to burst or leak, possibly damaging the interior of the cash register.
 - **Be sure that the the positive (+) and negative (-) poles of each battery are facing in the proper direction for installation.**
 - **Never mix batteries of different types.**
 - **Never mix old batteries and new ones.**
 - **Never leave dead batteries in the battery compartment.**
 - **Remove the batteries if you do not plan to use the cash register for long periods.**
 - **Should a battery leak, clean out the battery compartment immediately, taking care to avoid letting the battery fluid come into direct contact with your skin.**
 - **For battery disposal, follow the corresponding law in your country.**
- **If the register malfunctions, call 1-800-BE-SHARP for service - do not try to repair the register yourself.**
- **For a complete electrical disconnection, disconnect the main plug.**

**Customer Service Hotline
1-800-BE-SHARP**

**For Easy Set-up, see
“GETTING STARTED” ([page 7](#)).**

**The Spanish version (summary of English version) is after the English version.
La versión española (el resumen de la versión inglesa) sigue a la versión inglesa.**

CONTENTS

INTRODUCTION	1
IMPORTANT	1
CONTENTS	2
PARTS AND THEIR FUNCTIONS	4
1 External View	4
2 Printer	4
3 Mode Switch and Mode Keys	5
4 Keyboard	5
5 Displays	6
6 Drawer Lock Key	6
GETTING STARTED	7

FOR THE OPERATOR

OVERVIEW OF FLOW OF DAILY SALES ENTRIES	11
BASIC SALES ENTRY	12
1 Basic Sales Entry Example	12
2 Error Warning	13
3 Item Entries	14
Single item entries	14
Repeat entries	15
Multiplication entries	15
Split pricing entries	16
Single item cash sale (SICS) entry	17
4 Displaying Subtotal	17
5 Finalization of Transaction	17
Cash or check tendering	17
Cash or check sale that does not require tender entry	18
Charge (credit) sale	18
Mixed-tender sale	18
6 Tax Calculation	19
Automatic tax	19
Manual tax	19
Tax delete	19
Tax status shift	20
OPTIONAL FEATURES	21
1 Auxiliary Entries	21
Discount and premium entries using the percent key	21
Discount and premium entries using the discount key	21
Refund entries	22
Non-add code number entries and printing	22
2 Auxiliary Payment Treatment	23
Currency conversion	23
Received-on Account and Paid-out Entries	24
No sale (exchange)	24
3 Automatic Sequence Key (AUTO key) Entries	24
CORRECTION	25
1 Correction of the Last Entry (direct void)	25
2 Correction of the Next-to-last or Earlier Entry (indirect void)	25
3 Subtotal Void	26
4 Correction of Incorrect Entries not Handled by the Direct or Indirect Void Function	26

FOR THE MANAGER

PRIOR TO PROGRAMMING	27
-----------------------------------	-----------

BASIC FUNCTION PROGRAMMING (For Quick Start)	27
1 Date and Time Programming	27
2 Tax Programming for Automatic Tax Calculation Function	28
Tax programming using a tax rate	28
The tax table (applicable to the add-on tax)	29
Quantity for doughnut tax exempt (for Canadian tax system)	31
AUXILIARY FUNCTION PROGRAMMING	32
1 Department Programming	32
2 PLU (Price Look-Up) and Subdepartment Programming	33
3 Miscellaneous Key Programming	35
Rate for [%1], [%2] and [CONV]	35
Amount for [⊖]	36
Percent rate limitation for [%1] and [%2]	36
Function parameters for [%1], [%2] and [⊖]	36
Function parameters for [CONV]	37
Entry digit limit for [RA], [RCPT/PO] and [TAX]	38
Function parameters for [CHK], [CH] and [CA/T/INS] (when using as CA key)	38
4 Text programming	39
ADVANCED PROGRAMMING	44
1 Register Number and Consecutive Number Programming	44
2 Electronic Journal (EJ) Programming	45
3 Various Function Selection Programming 1	47
Function selection for miscellaneous keys	47
Print format	48
Receipt print format	48
Function selection for tax	48
Other programming	49
4 Various Function Selection Programming 2	51
Power save mode	51
Logo message print format	51
Online time out setting	52
Thermal printer density	52
Language selection	53
Training clerk specification for training mode	53
AUTO key programming	54
5 Reading Stored Program	54
TRAINING MODE	56
READING (X) AND RESETTING (Z) OF SALES TOTALS	57
EJ REPORT READING AND RESETTING	60
OVERRIDE ENTRIES	61
CORRECTION AFTER FINALIZING A TRANSACTION (Void mode)	61
OPERATOR MAINTENANCE	62
1 In Case of Power Failure	62
2 In Case of Printer Error	62
3 Cautions in Handling the Printer and Recording Paper	62
4 Replacing the Batteries	63
5 Replacing the Paper Roll	63
6 Removing a Paper Jam	66
7 Cleaning the Printer (Print Head / Sensor / Roller)	66
8 Removing the Drawer	66
9 Opening the Drawer by Hand	66
10 Before calling for service	67
Error code table	67
SPECIFICATIONS	68

PARTS AND THEIR FUNCTIONS

1 External View

■ Front view

Operator display

Printer cover

Receipt paper

Keyboard

Drawer

Drawer lock

■ Rear view

Customer display
(Pop-up type)

Power cord

Mode switch

USB port

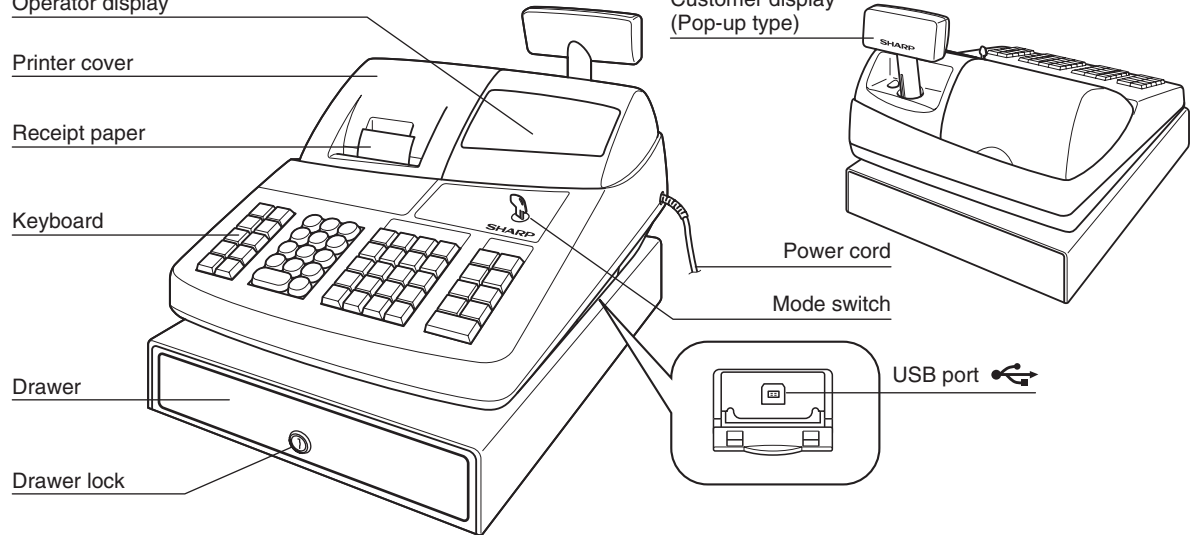

Note

Use only the USB cable (manufactured by SHARP) supplied with the XE-A20S for the connection with a PC. Never use other cables.

2 Printer

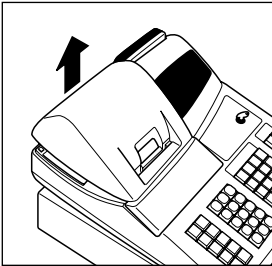

The printer is one station type thermal printer, therefore it does not require any type of ink ribbon or cartridge.

Lift the rear of the printer cover to remove. To re-install, hook the pawls on the cabinet and close.

Caution: The paper cutter is mounted on the printer cover. Be careful not to cut yourself.

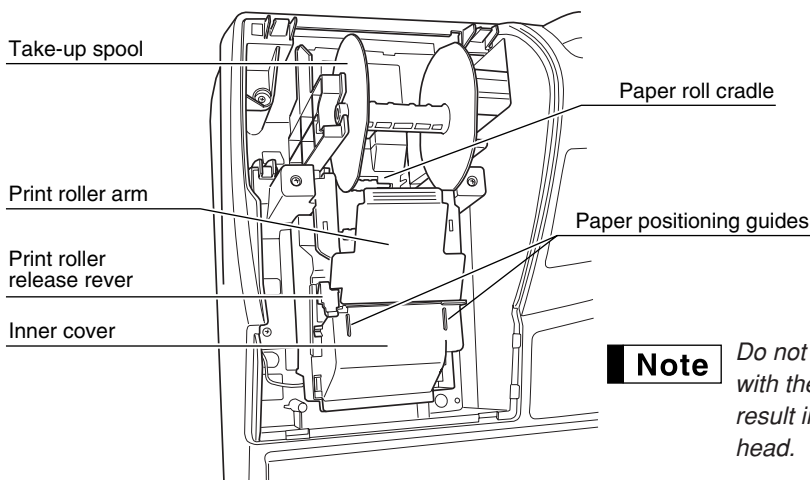

Note

Do not attempt to remove the paper roll with the print roller arm is locked. This may result in damage to the printer and print head.

3 Mode Switch and Mode Keys

The mode switch can be operated by inserting one of the two supplied mode keys - manager (MA) and operator (OP) keys. These keys can be inserted or removed only in the "REG" or "OFF" position.

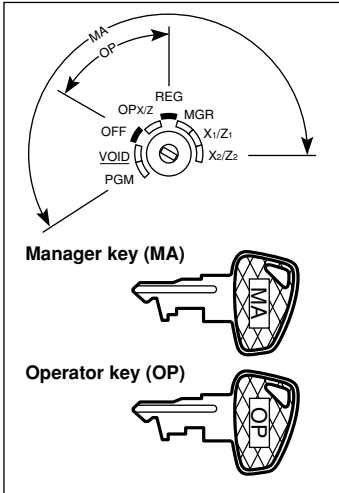

The mode switch has these settings:

- OFF:** This mode locks all register operations. (AC power turns off.) No change occurs to register data.
- OP X/Z:** To take individual clerk X or Z reports, and to take flash reports. It can be used to toggle receipt state "ON" and "OFF" by pressing the **RCPT/PO** key.
- REG:** For entering sales.
- PGM:** To program various items.
- VOID:** Enters into the void mode. This mode allows correction after finalizing a transaction.
- MGR:** For manager's entries. The manager can use this mode for an override entry.
- X1/Z1:** To take the X/Z report for various daily totals
- X2/Z2:** To take the X/Z report for periodic (weekly or monthly) consolidation

4 Keyboard

Keyboard layout

↑	CONV	@/FOR	•	CL	PLU /SUB A	DEPT # F	DEPT SHIFT K	CLK# P	TAX U	AUTO X
RA I	%1 /	7	8	9	20 4 B	24 8 G	28 12 L	32 16 Q	TAX1 SHIFT V	TAX2 SHIFT Y
RCPT /PO _	%2 NUMBER	4	5	6	19 3 C	23 7 H	27 11 M	31 15 R	CHK W	CH Z
VOID DC	RFND SHIFT	1	2	3	18 2 D	22 6 I	26 10 N	30 14 S	MDSE SBTL	#/TM SBTL
ESC BS	⊖ SPACE	0	00		17 1 E	21 5 J	25 9 O	29 13 T	CA/AT/NS	

Note

The small characters on the bottom or lower right in each key indicates functions or characters which can be used for character entries for text programming. For details, refer to [page 39](#).

Key names

↑	Paper feed key	@/FOR	Multiplication key	TAX	Tax key	
RA	Received-on account key	•	Decimal point key	TAX1 SHIFT	TAX2 SHIFT	Tax 1 and 2 shift keys
RCPT /PO	Receipt print/Paid-out key	CL	Clear key	AUTO	Automatic sequence key	
VOID	Void key	00	0 ~ 9	CHK	Check key	
ESC	Escape key	PLU /SUB	PLU/Subdepartment key	CH	Charge key	
CONV	Conversion key	DEPT #	Department code entry key	MDSE SBTL	Merchandise subtotal key	
%1 %2	Percent 1 and 2 keys	DEPT SHIFT	Department shift key	#/TM SBTL	Non-add code/Time display /Subtotal key	
RFND	Refund key	CLK#	Clerk code entry key	CA/AT/NS	Total/Amount tender /No sale key	
⊖	Discount key	17 1	~	32 16	Department keys	

5 Displays

Operator display

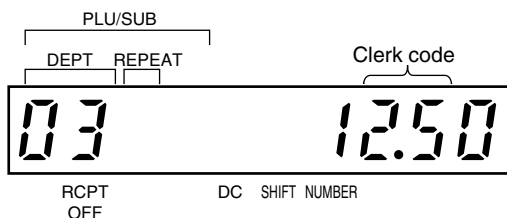

Customer display (Pop-up type)

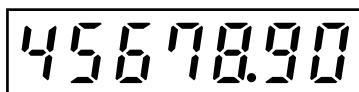

Amount: Appears in the far-right eight (max.) positions. When the amount is negative, the minus symbol “-” appears before the amount.

Number of repeats for repetitive registrations:

The number of repeats is displayed, starting at “2” and incremental with each repeat. When you have registered ten times, the display will show “0.” (2 → 3 … 9 → 0 → 1 → 2 …)

Receipt function status:

The indicator “_” appears in the RCPT OFF position when the receipt function is in the OFF status.

Time: Appears in the far-right six positions (hour-minute -“*A*” or hour-minute -“*P*”) in the OP X/Z, REG, or MGR mode. “*A*” is displayed in the morning (AM), and “*P*” in the afternoon (PM). In the REG or MGR mode, press the $\left[\frac{\#}{TMS/STL} \right]$ key to display the time.

Machine state symbols

P : Appears during programming.

E : Appears when an error is detected.

D : Appears when the subtotal is displayed or when the amount tendered is smaller than the sales amount.

C : Appears when the $\left[\text{CONV} \right]$ key is pressed to calculate a subtotal in foreign currency.

F : Appears when a transaction is finalized by pressing the $\left[\text{CA/AT/NS} \right]$, $\left[\text{CHK} \right]$ or $\left[\text{CH} \right]$ key.

$\left[\text{L} \right]$: Appears when the change due amount is displayed.

E-E : May appear in the far-left three positions at the timing of key entry when the electronic journal (EJ) memory is full. (Depending on programming.)

$\left[\text{L} \right]$: Appears when the voltage of the installed batteries is under the required level. You must replace with new ones within two days. Refer to [page 63](#) for details.

$\left[\text{L} \right]$: Appears when the batteries are not installed, or the installed batteries are dead. You must replace with new ones immediately. Refer to [page 63](#) for details.

• : May appear right below the eighth and ninth places at the timing of finalization of a transaction when the electronic journal (EJ) memory is nearly full.
Also appears right below the tenth place when power save mode is effective.

H : Appears when the print roller arm is not locked.

PPPPPPPPPP : Appears when the paper is not set or out.

6 Drawer Lock Key

This key locks and unlocks the drawer. To lock it, turn 90 degrees counterclockwise. To unlock it, turn 90 degrees clockwise.

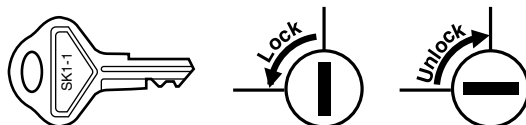

GETTING STARTED

Please follow the procedure shown below. The batteries are not installed and the power is OFF.

1

Installing the cash register

Find a stable surface where the cash register is not subject to water sources or direct sunlight near an AC outlet.

Unpack the cash register and make sure all accessories are included. For details of accessories, please refer to “Specifications” section.

2

Initializing the cash register

In order for your cash register to operate properly, you must initialize it before programming for the first time. Follow this procedure.

1. Insert the manager (MA) key into the mode switch and turn it to the REG position.
2. Insert the plug into the AC outlet. The buzzer will sound three times.
IMPORTANT: This operation must be performed without batteries installed.
3. The cash register has now been initialized. The register display will show “0.00” with “L”.

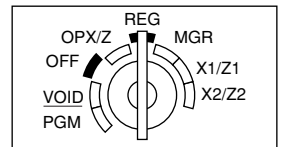

Note

If the buzzer does not sound when the plug is inserted, the initialization has not been done successfully. (This will occur when the voltage is still high because you operated the cash register just before starting initialization.) In this case, wait at least one minute after pulling out the plug, and insert the plug again.

3

Installing batteries

Three new “AA” batteries must be installed in the cash register to prevent the data and user-programmed settings from being erased from the memory, when the AC cord is accidentally disconnected or in case of power failure. Once installed, the batteries will last approximately one year before needing replacement. At this time, the “L” symbol will appear on the display to indicate the batteries are low and must be replaced within two days. If the no battery symbol “L” appears, you must install the batteries at once.

Install three new “AA” batteries according to the procedure shown below with the AC cord connected and the mode switch set to the REG position:

1. Push the printer cover forward and detach it.
Be careful with the paper cutter, so as not to cut yourself.
2. Open the battery compartment cover next to the paper roll cradle.

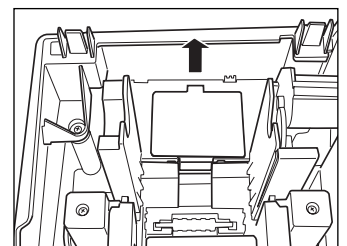

3. Insert three new “AA” batteries as illustrated at the right.
When the batteries are properly installed “L” on the display will disappear.
4. Close the battery compartment cover.

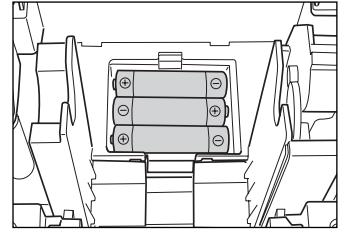

Note Be sure to observe precautions shown on [page 1](#) when handling batteries.

4 Installing a paper roll

Precaution: The paper cutter is mounted on the printer cover. Take caution when removing and installing the cover.

The register can print receipts or journals. For the printer, you must install the paper roll provided with the register, even when you program the register for not printing receipts or journals. Install the paper roll according to the procedure shown below with the AC cord connected and the mode switch set to the REG position:

1. Lift up the print roller release lever to unlock and open the print roller arm.

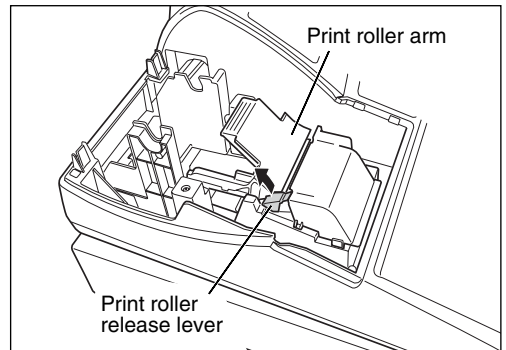

2. Set a paper roll in the paper roll cradle as illustrated at the right.

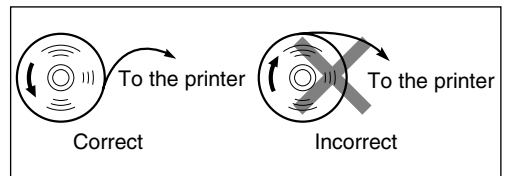

3. Feed the end of the paper along with the paper positioning guides as illustrated at the right.

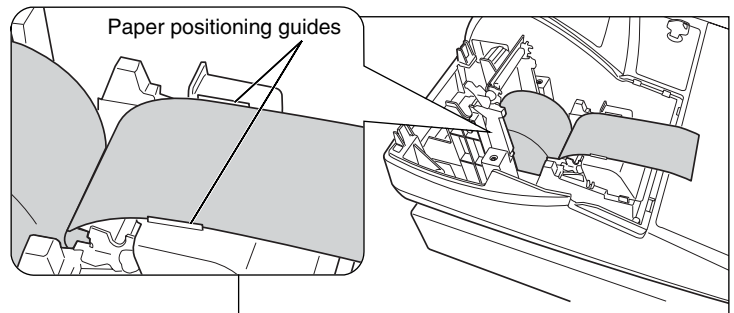

4. While holding down the paper, slowly close the print roller arm, and push down the arm until you hear a click locking the arm. Make sure securely you push down the center of the wing part of the arm as illustrated at the right. The paper will be fed automatically.

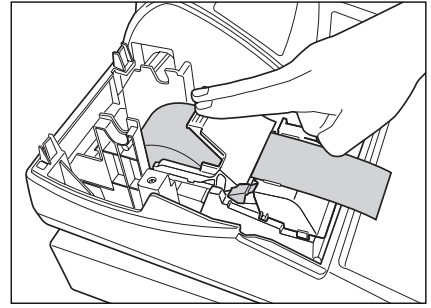

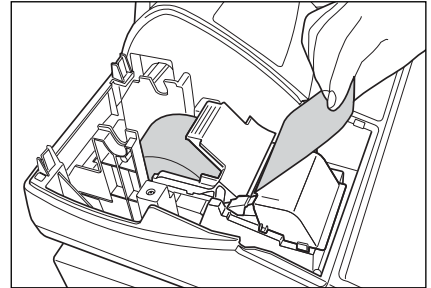

Note *If the print roller arm is not securely locked, printing is not done right. If this problem occurs, open the arm, and close the arm as instructed above.*

5. **When not using the take-up spool (using as receipt paper):**
- Cut off the excess paper using the edge of the inner cover, and replace the printer cover. Press the  key to make sure the paper end comes out of the printer cover and clean paper appears.



Note *If the paper end does not come out, open the printer cover, and pass the paper end between the paper cutter and the paper guide of the printer cover, and replace the cover.*

When using the take-up spool (using as journal paper):

- Insert the end of the paper into the slit in the spool. (Press the  key to feed more paper if required.)
- Wind the paper two or three turns around the spool shaft.
- Set the spool on the bearing, and press the  key to take up excess slack in the paper.
- Replace the printer cover.

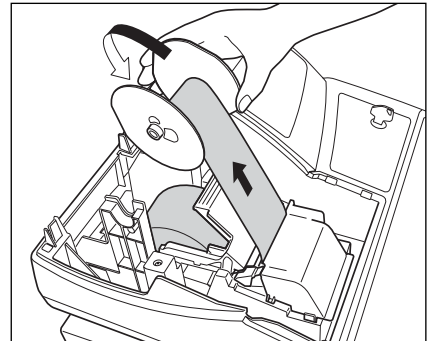

Note *When using a paper roll as journal paper, you must change the printing style. Refer to "Print Format" in "Various Function Selection Programming 1" section (Job code 6) for changing the printing style.*

5 Programming date, time and tax

Note *The cash register provides text languages of English, French and Spanish. It is preset to English. If you want to change the language, you must change it before programming. Refer to "Language selection" in "Various Function Selection Programming 2" section for changing the language.*

Before you can proceed with registration of sales, **you must program:**

- **date**
- **time**
- **tax**

Please refer to the BASIC FUNCTION PROGRAMMING section for details ([page 27](#)).

6

Programming other necessary items

While the cash register is pre-programmed so it can be used with minimal setup, it does provide you with optional functions. Before you start programming, please read through the sales operations section to understand optional functions. The main optional functions are listed below.

- PLU (price lookup)
- Consecutive number
- Machine number
- Receipt or journal printing selection (factory setting: receipt printing)
- Power save mode (factory setting: goes into power save mode in 30 minutes)
- Electronic journal (EJ) memory size (factory setting: 2000 lines are storable. Up to 3000 lines)
The memory for electronic journal is commonly used for PLU. If you change the setting, the maximum number of PLU code will decrease from 1200 to 200.
- Text programming for clerk name, department items, PLU/subdepartment items, logo messages printed on the top or bottom of receipts, function texts and foreign currency symbol
- Split pricing entry
This is not factory preset. You must enable this function.
- Foreign currency conversion rate
You must set a conversion rate to use **CONV** key.
- Preset unit price for departments and PLUs
- Preset amount for **⊖**
- Preset rates for **%1** **%2**
You do not have to program these preset prices/amount/rates because you can enter when registration. It might be convenient to preset so you do not have to re-enter every time.
- Amount entry digit limit for PO amount, RA amount, Manual tax amount
The factory setting makes the maximum amount you can enter. You can program to limit the amount.
- Key sequence for AUTO key
- Online time out setting
- Specification of clerk to be trained

Department programming:

The cash register is pre-programmed for departments as follows:

Department: Allow open price entry, taxable status- taxable 1 for department 1 to 10, and non taxable for department 11 to 99

When you use department 11 or above, and/or you apply taxable status other than taxable 1 for department 1 to 10, you must change department settings. Please refer to the department programming section for programming details.

7

Starting sales entries

Now you are ready for sales registration.

OVERVIEW OF FLOW OF DAILY SALES ENTRIES

Things to do before you start sales entries:

- Make sure the power cord is securely inserted into the AC outlet.
- Turn the mode switch to OP X/Z position, and check if time is correctly set.
- Replace the drawer, if removed for safety.
- Check if there is enough paper on roll.
- Select receipt ON/OFF function.
- Make any necessary programming for the day in PGM mode.

For details, refer to BASIC SALES ENTRY, [page 12](#). For drawer and paper roll, refer to OPERATOR MAINTENANCE, [page 62](#) and for programming, refer to programming sections.

Things you can do for sales entries:

- Item entries
- Item repeat entries
- Item multiplication entries
- Single item cash sale (SICS), if programmed.
- Split pricing entries, if programmed.
- Displaying subtotals
- Cash/Check/Charge sale
- Cash tendering in a foreign currency, if the currency conversion rate is programmed.
- Manual tax entry
- Discount or premium using and key
- Refund entry
- No sale
- Paid-out entries
- Received on account entries
- Printing non-add code number
- Making corrections
- Checking sales report

For details of sales entry method, refer to BASIC SALES ENTRY ([page 12](#)) and OPTIONAL FEATURES ([page 21](#)). For details of correcting sales entries, refer to CORRECTION ([page 25](#)). For details on reading sales information, refer to READING (X) AND RESETTING (Z) OF SALES TOTAL ([page 57](#)).

Things to do after you close your store:

- Print sales reports, and clear sales data for the day.
- Print Electronic Journal (EJ) reports, and clear Electronic Journal (EJ) data, if necessary.
- Account money - comparing it with the amount in cash in drawer printed on the general report.
- Remove the drawer for safety.
- Turn the mode switch to OFF position.

For details of reading sales information, refer to READING (X) AND RESETTING (Z) OF SALES TOTAL ([page 57](#)) and EJ REPORT READING AND RESETTING ([page 60](#)). For details of removing the drawer and maintenance details, refer to OPERATOR MAINTENANCE ([page 62](#)).

BASIC SALES ENTRY

1 Basic Sales Entry Example

Listed below is a basic sales entry example when selling department items by cash. For operation details, please refer to each section.

Mode switch setting

1. Turn the mode switch to the REG position.

Clerk assignment

2. Enter your clerk code. (For example, clerk code is 1. Press the **1** and **CLK#** key in this order.) The clerk code 1 is automatically selected just after initialization of the cash register.

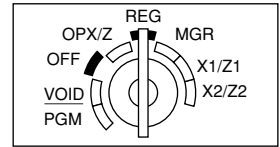

Item entries

3. Enter the price for the first department item. (For example, for 15.00, enter **1****5****00**, and press the appropriate department key.)

For department 17 to department 32, press the **DEPTSHIFT** key first before pressing the department key.

For department 33 and above, enter the department code using numeric keys, and press the **DEPT#** key, then enter the price and press the **DEPT#** key again.

4. Repeat step 3 for all the department items.

Displaying subtotals

5. Press the **#/TM/SBTL** key to display the amount due.

Finalizing the transaction

6. Enter the amount received from the customer. (You can omit this step if the amount tendered is the same as the subtotal.)
7. Press the **CA/AT/NS** key, and the change due is displayed (when the amount received was not entered, the total amount is displayed) and the drawer is opened.
8. Tear off the receipt and give it to the customer with his or her change.
9. Close the drawer.

Key operation example

Clerk assignment	→	1 CLK#	-01-
Item entries	{	1500 1 ¹⁷	01 15.00
		2300 2 ¹⁸	02 23.00
Displaying subtotal	→	#/TM/SBTL	40.38
		5000	50.00
Finalizing the transaction	→	CA/AT/NS	9.62

(In this example, the tax rate is set to 6.25%.)

Print

YOUR RECEIPT THANK YOU		Graphic logo
08/26/2005 2:33PM 01		Date/Time/Clerk code number
123456#0012 CLERK01		Register number /Consecutive number/Clerk name
DEPT. 01	T1 \$15.00	Items
DEPT. 02	T1 \$23.00	Price
MDSE ST	\$38.00	Merchandise subtotal
TAX1	\$2.38	Tax amount
		Tax status (T1: taxable 1)
ITEMS	2Q	Total quantity
***TOTAL	\$40.38	Total amount
CASH	\$50.00	Cash tendering/amount received
CHANGE	\$9.62	Change

Not printed when non-taxable items only are sold.

Clerk assignment

Prior to any item entries, clerks must enter their clerk codes into the register. However, the code entry may not be necessary when the same clerk handles the next transaction.

■ Sign-on (in REG, MGR, VOID mode)

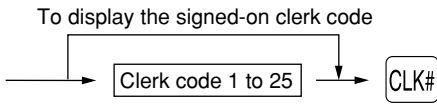

■ Sign-off (in REG, MGR, VOID mode)

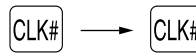

Receipt ON/OFF function

When you use the printer to issue receipts, you can disable receipt printing in the REG mode to save paper using the receipt ON/OFF function. To disable receipt printing, press the **RCPT/PO** key in the OP X/Z position. This key toggles the receipt printing status ON and OFF.

To check the receipt printing status, turn the mode switch to the OP X/Z position or press the **CL** key in the REG mode. When the function is in the OFF status, the receipt off indicator “_” is illuminated. Your register will print reports regardless of the receipt state, so the paper roll must be installed even when the receipt state is “OFF”.

To issue a receipt when receipt ON/OFF function is set to OFF:

If your customer wants a receipt after you finalized a transaction with the receipt ON/OFF function being OFF status, press the **RCPT/PO** key. This will produce a receipt. However, if more than 30 items were entered, the receipt will be issued in the format of summary receipt print.

Power Save Mode

The register will enter into power save mode when no entries are performed based on the pre-programmed time limit (by default, 30 minutes).

When your register goes to the power save mode, it will light off all the display except the decimal point at the leftmost position. Your register will return to the normal operation mode when any key is pressed or a mode is changed with the mode key. Please note when your register is recovered by a key entry, its key entry is invalid. After the recovery, start the key entry from the beginning.

2 Error Warning

In the following examples, your register will go into an error state accompanied with a warning beep and the error symbol “E” on the display. Clear the error state by pressing the **CL** key and take proper action.

Please refer to the error code table on [page 67](#).

- You enter over a 32-digit number (entry limit overflow): Cancel the entry and re-enter the correct number.
- You make an error in key operation: Clear the error and continue operation.
- You make an entry beyond a programmed amount entry limit: Check to see if the entered amount is correct. If it is correct, it can be rung up in the MGR mode. Contact your manager.
- An including-tax subtotal exceeds eight digits: Delete the subtotal by pressing the **CL** key and press the **CAVAT/NS**, **CHK** or **CH** key to finalize the transaction.

Error escape function

When you want to quit a transaction due to an error or an unforeseen event, use the error escape function as shown below:

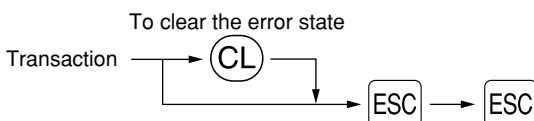

The transaction is voided (treated as a subtotal void) and the receipt is issued by this function. If you have already entered a tendered amount, the operation is finalized as a cash sale.

3 Item Entries

Single item entries

Department entries

The cash register provides a maximum of 99 departments for a merchandise classification. Group attributes, such as taxable status, are applied on items when they are entered to the departments.

• When using the department keys (for department 1 to 32)

For department 1 to 16, enter a unit price and press a department key. If you use a programmed unit price, press a department key only.

For department 17 to 32, enter a unit price, press the **DEPTSHIFT** key and press a department key. If you use a programmed unit price, press the **DEPTSHIFT** key and press a department key.

When using a programmed unit price

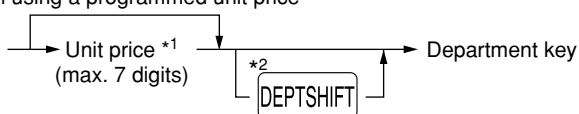

*1 Less than the programmed upper limit amounts
When zero is entered, only the sales quantity is added.

*2 For the optional departments 17 through 32, press the **DEPTSHIFT** key.

• When using the department code entry key

Enter a department(dept.) code and press the **DEPT#** key, then enter a unit price and press the **DEPT#** key again. If the dept. code is programmed to preset price entry style and a unit price is preset, your cash register will finish its registration operation.

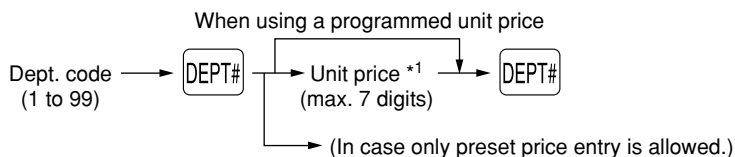

*1 Less than the programmed upper limit amounts
When zero is entered, only the sales quantity is added.

PLU/subdepartment entries

For another merchandise classification, the cash register provides a maximum of 1200 PLUs/subdepartments. PLUs are used to call up preset prices by a code entry. Subdepartments are used to classify merchandise into smaller groups under the departments. Every PLU and subdepartment has a code form 1 to 1200, and should belong to a department to obtain attributes of that department.

The cash register is pre-programmed to PLU mode and zero for unit price. To use PLU entries, their preset unit prices should be previously programmed. (Refer to [page 33.](#))

To use subdepartment entries, change to subdepartment mode for the PLU codes.

• PLU entries



• Subdepartment (open PLU) entries

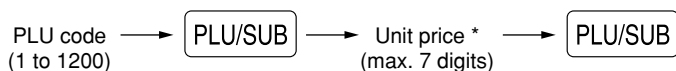

* Less than the programmed upper limit amounts
When zero is entered, only the sales quantity is added.

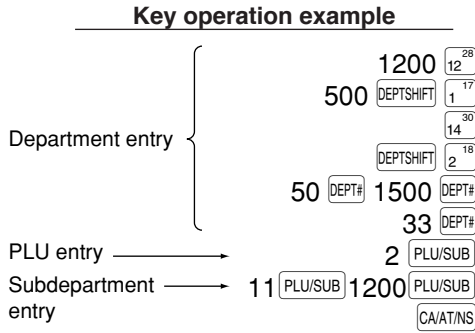

Print

DEPT. 12	\$12.00
DEPT. 17	\$5.00
DEPT. 14	\$8.25
DEPT. 18	\$3.25
DEPT. 50	\$15.00
DEPT. 33	\$2.50
PLU0002	\$1.50
PLU0011	\$12.00
ITEMS	8Q
CASH	\$59.50

Repeat entries

You can use this function for entering a sale of two or more of the same items. Repeat pressing a department key, DEPT# key or PLU/SUB key as shown on key operation example.

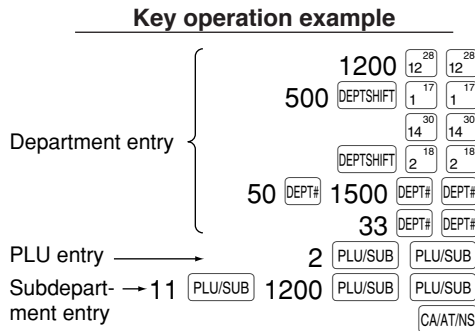

Print

DEPT. 12	\$12.00
DEPT. 12	\$12.00
DEPT. 17	\$5.00
DEPT. 17	\$5.00
DEPT. 14	\$8.25
DEPT. 14	\$8.25
DEPT. 18	\$3.25
DEPT. 18	\$3.25
DEPT. 50	\$15.00
DEPT. 50	\$15.00
DEPT. 33	\$2.50
DEPT. 33	\$2.50
PLU0002	\$1.50
PLU0002	\$1.50
PLU0011	\$12.00
PLU0011	\$12.00
ITEMS	16Q
CASH	\$119.00

Multiplication entries

When you sell a large quantity of items, it is convenient to use the multiplication entry method. Enter quantity using numeric keys and press the (Q) key before starting item entry as shown in the example below.

Note When programmed to allow fractional quantity entries, you can enter up to four integers and three digit decimal, though the quantity is counted as one for sales reports. To enter a fractional quantity, use the decimal point key between integer and decimal, as (7) (.) (5) for entering 7.5.

Key operation example

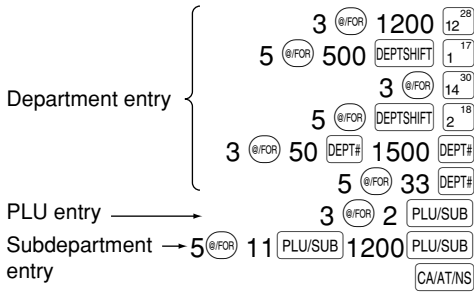

Print

DEPT. 12	3 @ \$12.00	\$36.00
DEPT. 17	5 @ \$5.00	\$25.00
DEPT. 14	3 @ \$8.25	\$24.75
DEPT. 18	5 @ \$3.25	\$16.25
DEPT. 50	3 @ \$15.00	\$45.00
DEPT. 33	5 @ \$2.50	\$12.50
PLU0002	3 @ \$1.50	\$4.50
PLU0011	5 @ \$12.00	\$60.00
ITEMS	32Q	
CASH		\$224.00

Split pricing entries

This function is practical when the customer wants to purchase items normally sold in bulk. To realize this function, you must change the programmed setting. Refer to "Various Function Selection Programming 1" (job code 70) for programming details.

To make split pricing entries, follow the procedure below:

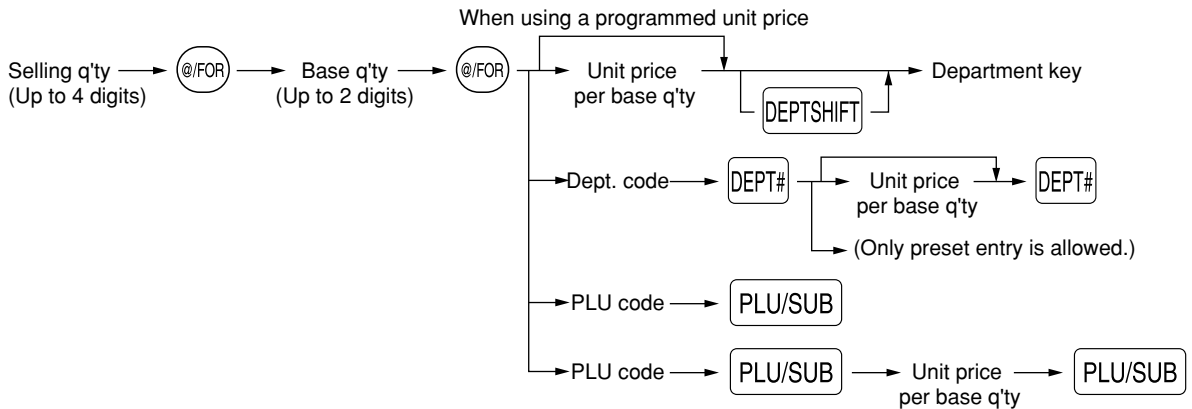

Key operation example

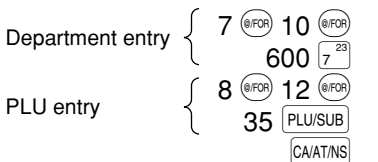

Print

DEPT. 07	7 @ 10/ \$6.00	T1 \$4.20
PLU0035	8 @ 12/ \$10.00	T1 \$6.67
MDSE ST		\$10.87
TAX1		\$0.68
ITEMS	2Q	
CASH		\$11.55

■ Single item cash sale (SICS) entry

- This function is useful when a sale is for only one item and is for cash. This function is applicable only to those departments that have been set for SICS or to their associated PLUs or subdepartments.
- The transaction is complete and the drawer opens as soon as you press the department key, **DEPT#** key or **PLU/SUB** key.

Key operation example

For finishing the transaction → 250 **9**²⁵

Print

DEPT. 09	T1	\$2.50
MOSE ST		\$2.50
TAX1		\$0.16
ITEMS	1Q	
CASH		\$2.66

Note

If an entry to a department or PLU/subdepartment set for SICS follows the ones to departments or PLUs/subdepartments not set for SICS, it does not finalize and results in a normal sale.

4 Displaying Subtotals

The register provides three types of subtotals:

Merchandise subtotal

Press the **MDSESBTL** key at any point during a transaction. The net sale subtotal - not including tax - will appear in the display.

Taxable subtotal

Taxable 1 subtotal

Press the **TAX1SHIFT** and **#TMSBTL** keys in this order at any point during a transaction. The sale subtotal of taxable 1 items will appear in the display.

Taxable 2 subtotal

Press the **TAX2SHIFT** and **#TMSBTL** keys in this order at any point during a transaction. The sale subtotal of taxable 2 items will appear in the display.

Including-tax subtotal (full subtotal)

Press the **#TMSBTL** key at any point during a transaction. The sale subtotal including tax and the symbol “**□**” will appear in the display.

5 Finalization of Transaction

■ Cash or check tendering

Press the **#TMSBTL** key to get an including tax subtotal, enter the amount tendered by your customer, then press the **CAI/ATNS** key if it is a cash tender or press the **CHK** key if it is a check tender. When the amount tendered is greater than the amount of the sale, your register will show the change due amount and the symbol “**□**” will light up. Otherwise the register will show a deficit and the symbol “**□**” will light up. You now must make a correct tender entry.

Cash tendering

Key operation example

1000 **#TMSBTL** **CAI/ATNS**

Print

ITEMS	3Q	
***TOTAL		\$7.35
CASH		\$10.00
CHANGE		\$2.65

Check tendering

Key operation example

}
#/TM/SBTL
1000 **CHK**

Print

ITEMS	3Q	
***TOTAL		\$7.35
CHECK		\$10.00
CHANGE		\$2.65

■ Cash or check sale that does not require entry

Enter items and press the **CA/AT/NS** key if it is a cash sale or press the **CHK** if it is a check sale. Your register will display the total sale amount.

Key operation example

300 **6**²²
10 **PLU/SUB**
CA/AT/NS

Print

DEPT. 06	T1	\$3.00
PLU0010	T1	\$7.15
MOSE ST		\$10.15
TAX1		\$0.63
ITEMS	2Q	
CASH		\$10.78

In the case of check sale

ITEMS	2Q	
CHECK		\$10.78

■ Charge (credit) sale

Enter items and press the charge key (**CH**).

Key operation example

2500 **6**²²
3250 **7**²³
CH

Print

DEPT. 06	T1	\$25.00
DEPT. 07	T1	\$32.50
MOSE ST		\$57.50
TAX1		\$3.59
ITEMS	2Q	
CHARGE		\$61.09

■ Mixed-tender sale

You can perform mixed-tendering of check and cash, cash and charge, and check and charge.

Example: Your customer pays \$9.50 in cash and \$40.00 by charge for an including-tax subtotal of \$49.50.

Key operation example

}
#/TM/SBTL
950 **CA/AT/NS**
CH

Print

ITEMS	3Q	
***TOTAL		\$49.50
CASH		\$9.50
CHARGE		\$40.00

6 Tax Calculation

Automatic tax

When the register is programmed with a tax rate (or tax table) and the tax status of an individual department is set for taxable, it computes the automatic tax on any item that is entered directly into the department or indirectly via a related PLU.

Example: Selling five \$6.70 items (dept. 1, taxable 1) and one \$7.15 item (PLU no. 85, taxable 2) for cash

Key operation example	Print																								
5 <input type="button" value="B/FOUR"/> 670 <input type="button" value="1"/> <input type="button" value="T7"/> 85 <input type="button" value="PLU/SUB"/> <input type="button" value="CA/AT/NS"/>	<table border="1"> <tr> <td></td> <td>5 @ \$6.70</td> <td></td> </tr> <tr> <td>DEPT. 01</td> <td>T1</td> <td>\$33.50</td> </tr> <tr> <td>PLU0085</td> <td>T2</td> <td>\$7.15</td> </tr> <tr> <td>MOSE ST</td> <td></td> <td>\$40.65</td> </tr> <tr> <td>TAX1</td> <td></td> <td>\$2.09</td> </tr> <tr> <td>TAX2</td> <td></td> <td>\$0.29</td> </tr> <tr> <td>ITEMS</td> <td>6Q</td> <td></td> </tr> <tr> <td>CASH</td> <td></td> <td>\$43.03</td> </tr> </table>		5 @ \$6.70		DEPT. 01	T1	\$33.50	PLU0085	T2	\$7.15	MOSE ST		\$40.65	TAX1		\$2.09	TAX2		\$0.29	ITEMS	6Q		CASH		\$43.03
	5 @ \$6.70																								
DEPT. 01	T1	\$33.50																							
PLU0085	T2	\$7.15																							
MOSE ST		\$40.65																							
TAX1		\$2.09																							
TAX2		\$0.29																							
ITEMS	6Q																								
CASH		\$43.03																							

Manual tax

The machine allows you to enter tax manually after it finalizes an item entry.

Example: Selling an \$8.00 item (dept. 12) for cash with 50 cents as tax

Key operation example	Print												
800 <input type="button" value="12"/> <input type="button" value="28"/> 50 <input type="button" value="TAX"/> <input type="button" value="CA/AT/NS"/>	<table border="1"> <tr> <td>DEPT. 12</td> <td></td> <td>\$8.00</td> </tr> <tr> <td>M-TAX</td> <td></td> <td>\$0.50</td> </tr> <tr> <td>ITEMS</td> <td>1Q</td> <td></td> </tr> <tr> <td>CASH</td> <td></td> <td>\$8.50</td> </tr> </table>	DEPT. 12		\$8.00	M-TAX		\$0.50	ITEMS	1Q		CASH		\$8.50
DEPT. 12		\$8.00											
M-TAX		\$0.50											
ITEMS	1Q												
CASH		\$8.50											

Tax delete

You can delete the automatic tax on the taxable 1 and taxable 2 subtotal of each transaction by pressing the key after the subtotal is displayed.

To delete taxable 1 subtotal, press , to get taxable 1 subtotal, and then press to delete the subtotal.

To delete taxable 2 subtotal, press , to get taxable 2 subtotal, and then press to delete the subtotal.

To delete all taxable (1-4) subtotal, press , , and in this order.

Example: Selling a \$7.25 item (dept. 1, taxable 1) and another \$5.15 item (dept. 11, taxable 2) for cash and entering the sale as a non-taxable one

Key operation example	Print																		
725 <input type="button" value="1"/> <input type="button" value="T7"/> 515 <input type="button" value="11"/> <input type="button" value="T7"/> <input type="button" value="TAX1SHIFT"/> <input type="button" value="#/TM/SBTL"/> <input type="button" value="TAX"/> <input type="button" value="TAX2SHIFT"/> <input type="button" value="#/TM/SBTL"/> <input type="button" value="TAX"/> <input type="button" value="CA/AT/NS"/>	<table border="1"> <tr> <td>DEPT. 01</td> <td>T1</td> <td>\$7.25</td> </tr> <tr> <td>DEPT. 11</td> <td>T2</td> <td>\$5.15</td> </tr> <tr> <td>TAX1 ST</td> <td></td> <td>\$0.00</td> </tr> <tr> <td>TAX2 ST</td> <td></td> <td>\$0.00</td> </tr> <tr> <td>ITEMS</td> <td>2Q</td> <td></td> </tr> <tr> <td>CASH</td> <td></td> <td>\$12.40</td> </tr> </table>	DEPT. 01	T1	\$7.25	DEPT. 11	T2	\$5.15	TAX1 ST		\$0.00	TAX2 ST		\$0.00	ITEMS	2Q		CASH		\$12.40
DEPT. 01	T1	\$7.25																	
DEPT. 11	T2	\$5.15																	
TAX1 ST		\$0.00																	
TAX2 ST		\$0.00																	
ITEMS	2Q																		
CASH		\$12.40																	

■ Tax status shift

The machine allows you to shift the programmed tax status of each department or the PLU key by pressing the **TAX1SHIFT** and/or **TAX2SHIFT** keys before those keys. After each entry is completed, the programmed tax status of each key is resumed.

Example: Selling the following items for cash with their programmed tax status reversed

- One \$13.45 item of dept. 16 (non-taxable) as a taxable 1 item
- One \$7.00 item of PLU no. 25 (non-taxable) as a taxable 1 and 2 item
- One \$4.00 item of dept. 11 (taxable 2) as a non-taxable item
- Two \$10.50 items of dept. 1 (taxable 1) as taxable 2 items

Key operation example

```

1345 TAX1SHIFT 16
25 TAX1SHIFT TAX2SHIFT PLU/SUB
400 TAX2SHIFT 11
1050 TAX1SHIFT TAX2SHIFT 1
1
CAVAT/NS
  
```

Print

DEPT. 16	T ₁	\$13.45
PLU0025	T ₁₂	\$7.00
DEPT. 11		\$4.00
DEPT. 01	T ₂	\$10.50
DEPT. 01	T ₂	\$10.50
MDSE ST		\$45.45
TAX1		\$1.28
TAX2		\$1.12
ITEMS	50	
CASH		\$47.85

Note

When Canadian tax system is applied:

When using a tax status shift, the entry of a multi-taxable item for PST or GST will be prohibited.

Please see below:

In case of; Tax 1: PST, Tax 2: PST,
Tax 3: PST, Tax 4: GST

Taxable 1 and 2 item prohibited
 Taxable 1 and 3 item..... prohibited
 Taxable 2 and 3 item prohibited
 Taxable 1 and 4 item allowed
 Taxable 2 and 4 item allowed
 Taxable 3 and 4 item allowed

In case of; Tax 1: PST, Tax 2: PST,
Tax 3: GST, Tax 4: GST

Taxable 1 and 2 item prohibited
 Taxable 1 and 3 item allowed
 Taxable 2 and 3 item allowed
 Taxable 1 and 4 item allowed
 Taxable 2 and 4 item allowed
 Taxable 3 and 4 item prohibited

OPTIONAL FEATURES

1 Auxiliary Entries

■ Discount and premium entries using the percent key

The percent key is used to apply a manually entered or preset discount or premium percent rate to individual items or to a merchandise subtotal. In the default setting, you can manually enter a discount percent rate to both individual items and merchandise subtotal. For manual entry of discount or premium percent rate, enter the rate (up to 100.00) with the numeric keys (you need a decimal point when you enter a fractional percent rate), and press a percent key. When using a preset rate (if programmed), just press a percent key. When entry limit is programmed for a percent key, you can not enter a rate over the limit (error code 34 will occur.)

Percent calculation for the merchandise subtotal

Key operation example	Print																						
4 <input type="button" value="@/FOR"/> 140 <input type="button" value="5"/> <input type="button" value="21"/> 570 <input type="button" value="7"/> <input type="button" value="23"/> <input type="button" value="MDESEBTL"/> 10 <input type="button" value="%1"/> <input type="button" value="CA/AT/NS"/>	<table border="0" style="width: 100%;"> <tr> <td style="width: 60%;"></td> <td style="text-align: right;">4 @ \$1.40</td> </tr> <tr> <td>DEPT. 05</td> <td style="text-align: right;">T1 \$5.60</td> </tr> <tr> <td>DEPT. 07</td> <td style="text-align: right;">T1 \$5.70</td> </tr> <tr> <td>MDSE ST</td> <td style="text-align: right;">\$11.30</td> </tr> <tr> <td></td> <td style="text-align: right;">-10%</td> </tr> <tr> <td>%1</td> <td style="text-align: right;">-1.13</td> </tr> <tr> <td>MDSE ST</td> <td style="text-align: right;">\$10.17</td> </tr> <tr> <td>TAX1</td> <td style="text-align: right;">\$0.71</td> </tr> <tr> <td> </td> <td></td> </tr> <tr> <td>ITEMS</td> <td style="text-align: right;">5Q</td> </tr> <tr> <td>CASH</td> <td style="text-align: right;">\$10.88</td> </tr> </table>		4 @ \$1.40	DEPT. 05	T1 \$5.60	DEPT. 07	T1 \$5.70	MDSE ST	\$11.30		-10%	%1	-1.13	MDSE ST	\$10.17	TAX1	\$0.71	 		ITEMS	5Q	CASH	\$10.88
	4 @ \$1.40																						
DEPT. 05	T1 \$5.60																						
DEPT. 07	T1 \$5.70																						
MDSE ST	\$11.30																						
	-10%																						
%1	-1.13																						
MDSE ST	\$10.17																						
TAX1	\$0.71																						
ITEMS	5Q																						
CASH	\$10.88																						

Percent calculation for item entries

Key operation example	Print																						
800 <input type="button" value="6"/> <input type="button" value="22"/> 7 <input type="button" value="5"/> <input type="button" value="%1"/> 15 <input type="button" value="PLU/SUB"/> <input type="button" value="%2"/> <input type="button" value="CA/AT/NS"/>	<table border="0" style="width: 100%;"> <tr> <td style="width: 60%;"></td> <td style="text-align: right;">T1 \$8.00</td> </tr> <tr> <td>DEPT. 06</td> <td style="text-align: right;">-7.5%</td> </tr> <tr> <td>%1</td> <td style="text-align: right;">-0.60</td> </tr> <tr> <td>PLU0015</td> <td style="text-align: right;">T1 \$5.00</td> </tr> <tr> <td></td> <td style="text-align: right;">15.00%</td> </tr> <tr> <td>%2</td> <td style="text-align: right;">\$0.75</td> </tr> <tr> <td>MDSE ST</td> <td style="text-align: right;">\$13.15</td> </tr> <tr> <td>TAX1</td> <td style="text-align: right;">\$0.81</td> </tr> <tr> <td> </td> <td></td> </tr> <tr> <td>ITEMS</td> <td style="text-align: right;">2Q</td> </tr> <tr> <td>CASH</td> <td style="text-align: right;">\$13.96</td> </tr> </table>		T1 \$8.00	DEPT. 06	-7.5%	%1	-0.60	PLU0015	T1 \$5.00		15.00%	%2	\$0.75	MDSE ST	\$13.15	TAX1	\$0.81	 		ITEMS	2Q	CASH	\$13.96
	T1 \$8.00																						
DEPT. 06	-7.5%																						
%1	-0.60																						
PLU0015	T1 \$5.00																						
	15.00%																						
%2	\$0.75																						
MDSE ST	\$13.15																						
TAX1	\$0.81																						
ITEMS	2Q																						
CASH	\$13.96																						

(When premium and 15% are programmed for the key)

■ Discount and premium entries using the discount key

The discount key is used to apply a manually entered or preset discount or premium amount to individual items or to a merchandise subtotal. In the default setting, you can manually enter a discount amount to both individual items and merchandise subtotal. For manual entry of discount or premium amounts, enter the amount with the numeric keys, and press the discount key. When using a preset amount (if programmed), press the discount key.

When entry digit limit is programmed for the discount key, you can not enter an amount over the limit (error code 34 will occur.)

Discount for the merchandise subtotal

Key operation example

575 ²²
 10

 100

Print

DEPT. 06	T1	\$5.75
PLU0010	T1	\$7.15
MDSE ST		\$12.90
(-)		-1.00
MDSE ST		\$11.90
TAX1		\$0.81
ITEMS	2Q	
CASH		\$12.71

Discount for item entries

Key operation example

675 ²³

Print

DEPT. 07	T1	\$6.75
(-)		-0.75
MDSE ST		\$6.00
TAX1		\$0.42
ITEMS	1Q	
CASH		\$6.42

(When a discount amount of \$0.75 is programmed.)

Refund entries

For departments 1 to 16, enter the refund amount and press the key, and then press the corresponding department key and for departments 17 to 32, enter the refund amount and press the key, then press the key and press the corresponding department key (when using the preset price, omit entering the amount). In case of department 33 to 99, enter the department code and press key and the key, then enter the refund amount and press the key if necessary.

For a refund of a PLU item, enter the PLU code and press the key, then press the key.

For a refund of a subdepartment item, enter the PLU code and press the key and key, then enter the refund amount and press the key.

Key operation example

250 ²²
 33 100
 7
 13
 15 150

Print

DEPT. 06	T1	R-2.50
DEPT. 33	T1	R-1.00
		-7 @ \$2.10
PLU0013	T1	R-14.70
PLU0015	T1	R-1.50
MDSE ST		-19.70
TAX1		-1.23
ITEMS	0Q	
CHANGE		\$20.93

Non-add code number entries and printing

You can enter a non-add code number such as a customer's code number and credit card number, a maximum of 16 digits, at any point during the entry of a sale. The cash register will print it at once.

To enter a non-add code number, enter the number and press the key.

Key operation example

1230 #TMSBTL
 1500 6²²
 CH

Print

#1230	
DEPT. 06	T1 \$15.00
MDSE ST	\$15.00
TAX1	\$0.94
ITEMS	1Q
CHARGE	\$15.94

2 Auxiliary Payment Treatment

■ Currency conversion

The register allows payment entries in a foreign currency (only cash payment is available). Pressing the **CONV** key creates a subtotal in the foreign currency.

When using a programmed currency conversion rate, press the **CONV** key after item entries, then enter the tendered amount in foreign currency if not exact amount payment, and press the **CAI/AT/NS** key.

When making a manual entry of currency conversion rate, after item entries, enter the conversion rate (0.0000 to 9999.9999; you need a decimal point when you enter fractional conversion rate) and press the **CONV** key, then enter the tendered amount in foreign currency if not exact amount payment, and press the **CAI/AT/NS** key.

In both cases, the change due will be displayed in domestic currency, and when the amount tendered is short, the deficit is shown in domestic currency.

- Note**
- Press the **CL** key after pressing the **CONV** key to cancel payment in a foreign currency.
 - If programmed, a foreign currency symbol is printed when you use a preset rate.

Applying preset conversion rate

Key operation example

2300 6²²
 4650 7²³
 Currency conversion → **CONV**
 Amount tendered in foreign currency → 10000 **CAI/AT/NS**

(When a currency conversion rate of 0.7674 is programmed for the **CONV** key.)

Print

DEPT. 06	T1 \$23.00	
DEPT. 07	T1 \$46.50	
MDSE ST	\$69.50	
TAX1	\$4.34	
ITEMS	2Q	
***TOTAL	\$73.84	Domestic currency
CONV 1	0.7674	Conversion rate
	€56.67	Foreign currency
CASH	€100.00	
CHANGE	\$56.46	Domestic currency

Foreign currency symbol
(Printed if programmed)

Applying manual conversion rate

Key operation example

2300 6²²
 4650 7²³
 Conversion rate → 1 0.275 **CONV**
 10000 **CAI/AT/NS**

Print

DEPT. 06	T1 \$23.00
DEPT. 07	T1 \$46.50
MDSE ST	\$69.50
TAX1	\$4.34
ITEMS	2Q
***TOTAL	\$73.84
CONV 2	1.275
	94.15
CASH	100.00
CHANGE	\$4.58

■ Received-on Account and Paid-out Entries

When you receive on account from a customer or when you pay an amount to a vendor, it is a good idea to use the **RA** key or the **RCPT/PO** key respectively.

For the received-on-account (RA) entry, enter the amount, and press the **RA** key.

For the paid-out (PO) entry, enter the amount and press the **RCPT/PO** key.

Note *Cash tendering only available for RA and PO operation.*

Key operation example

12345 **#TM/SBTL**
4800 **RA**

Print

	#12345	
***RA		\$48.00

■ No sale (exchange)

When you need to open the drawer with no sale, just press the **CA/AT/NS** key. The drawer will open and printer will print "NO SALE" on the receipt or journal. If you let the machine print a non-add code number before pressing the **CA/AT/NS** key, a no sale entry is achieved and a non-add code number is printed.

#45678
NO SALE

3 Automatic Sequence Key (**AUTO** key) Entries

You can achieve a programmed transaction simply by pressing the **AUTO** key.

Key operation example

AUTO

(**AUTO**) = 500 **7** **CA/AT/NS**

Print

DEPT. 07	T1	\$5.00
MDSE ST		\$5.00
TAX1		\$0.31
ITEMS	1Q	
CASH		\$5.31

CORRECTION

1 Correction of the Last Entry (direct void)

If you make an incorrect entry relating to a department, PLU/subdepartment, percentage (%1 and %2), discount (⊖) or refund, you can void this entry by pressing the **VOID** key immediately after the incorrect entry.

Key operation example

```

1250 [6] [22]
      [VOID]
2 [PLU/SUB]
  [VOID]
600 [8] [24]
     [%2]
     [VOID]
328 [9] [25]
    28 [⊖]
       [VOID]
250 [RFND] [6] [22]
     [VOID]
     [CA/AT/NS]
  
```

Print

DEPT. 06	T1	\$12.50
DEPT. 06	T1	V-12.50
PLU0002	T1	\$1.50
PLU0002	T1	V-1.50
DEPT. 08	T1	\$6.00
		15.00%
%2		\$0.90
%2		V-0.90
DEPT. 09	T1	\$3.28
(-)		-0.28
(-)		V\$0.28
DEPT. 06	T1	R-2.50
DEPT. 06	T1	RV\$2.50
MDSE ST		\$9.28
TAX1		\$0.58
ITEMS	2Q	
CASH		\$9.86

2 Correction of the Next-to-last or Earlier Entry (indirect void)

You can void any incorrect department entry, PLU/subdepartment entry or item refund entry made during a transaction if you find it before finalizing the transaction (e.g. pressing the **CA/AT/NS** key). This function is applicable to department, PLU/subdepartment and refund entries only.

For the operation, press the **VOID** key just before you press a department key, **DEPT#** key or **PLU/SUB** key. For the refund indirect void, press the **VOID** key after you press the **RFND** key.

Key operation example

```

1310 [6] [22]
1755 [7] [23]
10 [PLU/SUB]
12 [PLU/SUB]
250 [RFND] [6] [22]
825 [7] [23]
1310 [VOID] [6] [22]
12 [VOID] [PLU/SUB]
250 [RFND] [VOID] [6] [22]
     [CA/AT/NS]
  
```

Correction of a department entry →

Correction of a PLU entry →

Correction of a refund entry →

Print

DEPT. 06	T1	\$13.10
DEPT. 07	T1	\$17.55
PLU0010	T1	\$7.15
PLU0012	T1	\$3.00
DEPT. 06	T1	R-2.50
DEPT. 07	T1	\$8.25
DEPT. 06	T1	V-13.10
PLU0012	T1	V-3.00
DEPT. 06	T1	RV\$2.50
MDSE ST		\$32.95
TAX1		\$2.06
ITEMS	3Q	
CASH		\$35.01

3 Subtotal Void

You can void an entire transaction. Once subtotal void is executed, the transaction is aborted and the register issues a receipt. This function does not work when more than 30 items have been entered.

Key operation example

1310 ¹⁸
 ¹⁸
 1755 ²²
 10
 35
 Subtotal void {

Print

DEPT. 02	T1	\$13.10
DEPT. 02	T1	\$13.10
DEPT. 06	T1	\$17.55
PLU0010	T1	\$7.15
PLU0035	T1	\$3.00
MDSE ST		\$53.90
SBTL VD		-53.90
***TOTAL		\$0.00

4 Correction of Incorrect Entries not Handled by the Direct or Indirect Void Function

Any errors found after the entry of a transaction has been completed or during an amount tendered entry cannot be voided. These errors must be corrected by the manager.

The following steps should be taken:

1. If you are making the amount tendered entry, finalize the transaction.
2. Make correct entries from the beginning.
3. Hand the incorrect receipt to your manager for its cancellation.

PRIOR TO PROGRAMMING

Before starting sales entries, you must first program necessary items so that the cash register suits your sales manner. In this manual, there are three sections, **BASIC FUNCTION PROGRAMMING where required items must be programmed**, **AUXILIARY FUNCTION PROGRAMMING** where you can program for more convenient use of keys on the keyboard, and **ADVANCED FUNCTION PROGRAMMING** where various optional programming features are provided. Find the appropriate features for your needs, and make the necessary programming.

Note You can select the language of text (English, French or Spanish) printed on receipts or journals. For the language selection, please refer to "Language Selection" described later in this section.

■ Procedure for programming

1. Check to see whether a paper roll is present in the machine. If there is not enough paper on the roll, replace it with a new one (refer to MAINTENANCE section for the replacement).
2. Put the manager key in the mode switch and turn it to the PGM position.
3. Program necessary items into the cash register.
Every time you program an item, the cash register will print the setting. Please refer to print samples in each section.
4. If necessary, issue programming reports for your reference.

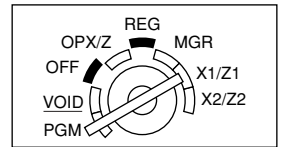

Note

- On the procedures and key operation examples shown in the programming details, numbers such as "08262005" indicates the parameter which must be entered using the corresponding numeric keys.
- Asterisks in the tables shown in the programming details indicate default settings.

BASIC FUNCTION PROGRAMMING

(For Quick Start)

1 Date and Time Programming

■ Date

For setting the date, enter the date in 8 digits using the month-day-year (MM/DD/YYYY) format, then press the **#/TM/SBTL** key.

Procedure Date(MM/DD/YYYY) → **#/TM/SBTL**

Key operation example

08262005 **#/TM/SBTL**
(Aug. 26, 2005)

Print

PGM 08/26/2005 — Date

Note You can use the date format of day-month-year (DD/MM/YYYY) or year-month-day (YYYY/MM/DD) format. To change the format, refer to "Various Function Selection Programming 1" section (Job code 61).

■ Time

For setting the time, enter the time in 4 digits using the 24-hour format. For example, when the time is set to 2:30 AM, enter 230; and when it is set to 2:30 PM, enter 1430.

Procedure

Time(max. 4 digits in 24-hour format) → #/TM/SBTL

Key operation example

1430 #/TM/SBTL

Print

PGM 2:30PM Time

Note

In the display, current time is displayed in 12-hour format. For AM time, “A” and for PM time “P” will appear in the rightmost position with the current time. If you want to display time in the 24-hour format, refer to “Various Function Selection Programming 1” section (Job code 61).

2 Tax Programming for Automatic Tax Calculation Function

Note

The cash register can support US and Canadian tax systems. If you use the Canadian tax system, you must first change the tax system, then program the tax rate or tax table and quantity for doughnut exempt which are described in this section. For changing your cash register's tax system, please refer to “Various Function Selection Programming 1” section (job code 70).

Before you can proceed with registration of sales, you must first program the tax that is levied in accordance with the law of your state. The cash register comes with the ability to program four different tax rates. In most states, you will only need to program Tax 1. However if you live in an area that has a separate local tax (such as a Parish tax) or a hospitality tax, the register can be programmed to calculate these separate taxes.

When you program the tax status for a department, tax will be automatically added to sales of items assigned to the department according to the programmed tax status for the department. You can also enter tax manually.

There are two tax programming methods. The tax rate method uses a straight percentage rate per dollar. The tax table method requires tax break information from your states or local tax offices. Use the method which is acceptable in your state. You can obtain necessary data for tax programming from your local tax office.

■ Tax programming using a tax rate

The percent rate specified here is used for tax calculation on taxable subtotals.

Procedure

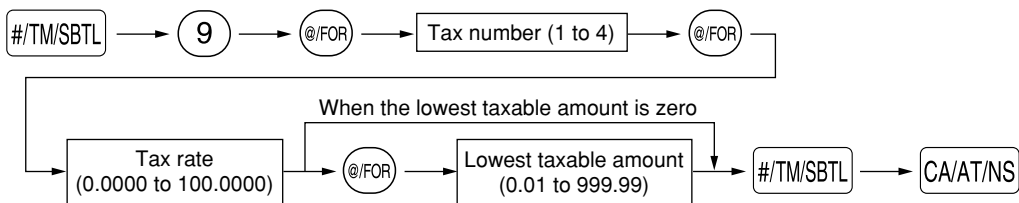

To delete a tax rate, use the following sequence:

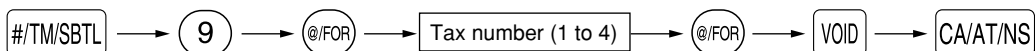

Example: Programming the tax rate 4% as tax rate 2 with tax exempt as 12¢

Key operation example



Print

PGM	
T2	4.0000%
	0.12

Note

- If you make an incorrect entry before pressing the third **@/F/O/R** key in programming a tax rate, cancel it with the **CL** key.
- You do not need to enter the trailing zeros of the tax rate (after the decimal point), but you do need to enter the decimal for fractions.
- The lowest taxable amount setting is ignored when you select VAT system for Canadian tax.

■ The tax table (applicable to the add-on tax)

If you are in an area that uses a tax table for tax calculation, you can program the cash register accordingly. Tax table programming can be performed for Tax 1 through Tax 4.

Sample tax table

New Jersey tax table: 6%

Taxes	Range of sales amount	
	Minimum breakpoint	Maximum breakpoint
.00	.01	to .10
.01 — T	.11 — Q	to .22
.02	.23	to .38
.03	.39	to .56
.04	.57	to .72
.05	.73	to .88
.06	.89	to 1.10
.07	1.11 — M1	to 1.22
.08	1.23	to 1.38
.09	1.39	to 1.56
.10	1.57	to 1.72
.11	1.73	to 1.88
.12	1.89	to 2.10
.13	2.11 — M2	to 2.22



A: Difference between the minimum breakpoint and the next one (¢)	
—	
10 (0.11 - 0.01)	B: Non-cyclic
12 (0.23 - 0.11)	C: Cyclic-1
16 (0.39 - 0.23)	
18 (0.57 - 0.39)	
16 (0.73 - 0.57)	
16 (0.89 - 0.73)	D: Cyclic-2
22 (1.11 - 0.89)	
12 (1.23 - 1.11)	
16 (1.39 - 1.23)	
18 (1.57 - 1.39)	
16 (1.73 - 1.57)	
16 (1.89 - 1.73)	
22 (2.11 - 1.89)	

To program a tax table, first make a table like the one shown above right.

From the tax table, calculate the differences between a minimum break point and the next one (A). Then, from the differences, find irregular cycles (B) and regular cycles (C and D). These cycles will show you the following items necessary to program the tax table:

- T:** The tax amount collected on the minimum taxable amount (Q)
- Q:** The minimum taxable amount
- M1:** The maximum value of the minimum breakpoint on a regular cycle (C)
We call this point "MAX point."
- M2:** The maximum value of the minimum breakpoint on a regular cycle (D)
We call this point "MAX point."
- M:** Range of the minimum breakpoint on a regular cycle: difference between Q and M1 or between M1 and M2

Procedure

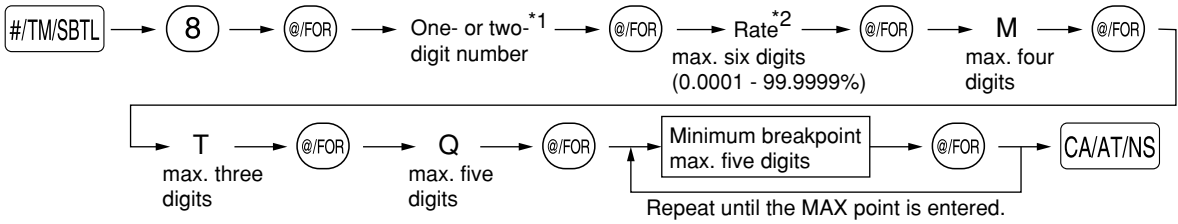

To delete a tax table, use the following sequence:

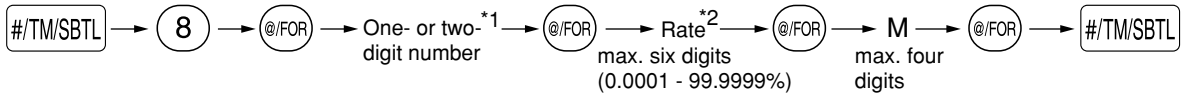

***1 First figure: (1 or 0)** The first figure to be entered depends upon whether the difference between a minimum breakpoint to be entered and the preceding minimum breakpoint is not less than \$1.00 or more than 99¢. When the difference is not less than \$1.00, enter “1,” and when it is not more than 99¢, enter “0” or nothing.

Second figure: (1 to 4) The second figure depends upon whether your tax table is to be programmed as tax table 1, 2, 3 or 4.

***2** If the rate is fractional (e.g. 4-3/8%), then the fractional portion (3/8) would be converted to its decimal equivalent (i.e. .375) and the resulting rate of 4.375 would be entered. Note that the nominal rate (R) is generally indicated on the tax table.

Note If you make an incorrect entry before entering the M in programming a tax table, cancel it with the **CL** key; and if you make an error after entering the M, cancel it with the **#/TM/SBTL** key. Then program again from the beginning.

• Limitations to the entry of minimum breakpoints

The register can support a tax table consisting of no more than 72 breakpoints. (The maximum number of breakpoints is 36 when the breakpoint difference is \$1.00 or more.) If the number of breakpoints exceeds the register’s table capacity, then the manual entry approach should be used.

Example: Programming the sample tax table shown on the previous page as tax table 1

Key operation example		Print
	#/TM/SBTL 8 @/FOR	*PGM*
	1 @/FOR	T1 6.0000%
Tax rate	→ 6 @/FOR	/ 1.00
M	→ 100 @/FOR	1 0.11
T	→ 1 @/FOR	2 0.23
Q	→ 11 @/FOR	3 0.39
The first cyclic portion	23 @/FOR	4 0.57
	39 @/FOR	5 0.73
	57 @/FOR	6 0.89
	73 @/FOR	7 1.11
M1 (MAX point)	→ 89 @/FOR	
	111 @/FOR	
	CA/AT/NS	

Note You do not need to enter the trailing zeros of the tax rate (after the decimal point) but you do need to enter the decimal point for fractions.

- If the tax is not provided for every cent, modify the tax table by setting the tax for every cent in the following manner.

When setting the tax, consider the minimum breakpoint corresponding to unprovided tax to be the same as the one corresponding to the tax provided on a large amount.

Sample tax table
Example 8%

Tax	Minimum breakpoint
.00	.01
.01	.11
.02	.26
.03	.47
.04	.68
.06	.89
.09	1.11
.10	1.26
.11	1.47
.12	1.68
.14	1.89
.17	2.11

Modification of the left tax table

Tax	Minimum breakpoint
.00	.01
.01 — T	.11 — Q
.02	.26
.03	.47
.04	.68
.05	.89
.06	.89
.07	1.11 — M1
.08	1.11
.09	1.11
.10	1.26
.11	1.47
.12	1.68
.13	1.89
.14	1.89
.15	2.11 — M2
.16	2.11
.17	2.11



Breakpoint difference (¢)	
1	
10 (0.11-0.01)	B: Non-cyclic
15 (0.26-0.11)	
21 (0.47-0.26)	
21 (0.68-0.47)	
21 (0.89-0.68)	
0 (0.89-0.89)	C: Cyclic-1
22 (1.11-0.89)	
0 (1.11-1.11)	
0 (1.11-1.11)	
15 (1.26-1.11)	
21 (1.47-1.26)	
21 (1.68-1.47)	
21 (1.89-1.68)	
0 (1.89-1.89)	D: Cyclic-2
22 (2.11-1.89)	
0 (2.11-2.11)	
0 (2.11-2.11)	

From the modified tax table above;
Rate = 8(%), T = \$0.01 = 1¢, Q = \$0.11 = 11¢, M1 = 1.11, M2 = 2.11, M = 100

Quantity for doughnut tax exempt (for Canadian tax system)

This option is available only when the Canadian tax system is selected.

Procedure

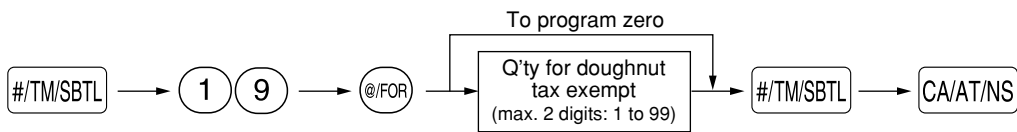

Example: To program the quantity "6"

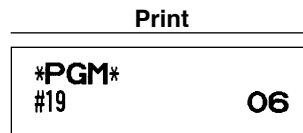
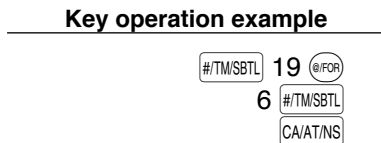

AUXILIARY FUNCTION PROGRAMMING

1 Department Programming

Merchandise can be classified into a maximum of 99 departments. Items sold with use of the department keys can later be printed on a report that shows the quantities sold and sales amounts classified by department. The data is useful for making purchasing decisions and other store operations. Departments can be assigned to articles whose prices were set using PLU/subdepartment function.

When using a department key, you must set the parameters to specify the department status, such as positive or negative department. Prices can be assigned directly to departments for frequently purchased items, which enables you to enter the prices by simply pressing the department keys or dept. code entries.

■ Department status

Procedure

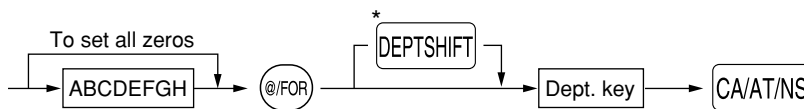

*To program departments 17 through 32, press the department shift key at this point.

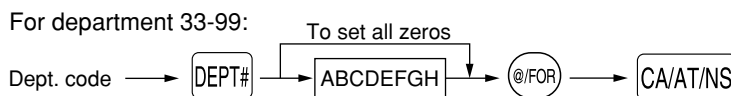

To program another department, start from the beginning without pressing the **CA/AT/NS** key.

Item:	Selection:	Entry:
A Tax 4 status	Taxable	1
	Non-taxable*	0
B Tax 3 status	Taxable	1
	Non-taxable*	0
C Tax 2 status	Taxable	1
	Non-taxable*	0
D Tax 1 status	Taxable (*for dept. 1 thru 10)	1
	Non-taxable (*for dept. 11 thru 99)	0
E SICS / Normal	SICS	1
	Normal*	0
F Sign	Negative department	1
	Positive department*	0
G Entry digit limit		0-7 (default: 7)
H Type of unit price entry	Open and preset	3
	Preset only	2
	Open only*	1
	Inhibit department key	0

Tax status (taxable 1 through 4 / non-taxable)

- When any entry of a taxable department is made in a transaction, tax is automatically computed according to the associated tax table or rate.

SICS (Single Item Cash Sale)

- If an entry of a department programmed for SICS is made first, the sale will be finalized as a cash sale as soon as the department key is pressed. If the entry is made after entering a department not programmed for SICS, the sale will not be finalized until the **CA/AT/NS** key is pressed.

Entry digit limit

- 32** • Set the number of allowable digits for the maximum entry amount for each department. The limit is effective for operations in the REG mode and can be overridden in the MGR mode.

Example: Programming department 2 as taxable 1, SICS, negative department, entry digit limit - 7 digits, and allowing open & preset entry. (ABCDEFGH: 00011173)

Key operation example	Print											
00011173 @IFOR 2 ¹⁸ CA/AT/NS	<table border="1" style="margin-left: auto; margin-right: auto;"> <tr> <td style="padding: 5px;">*PGM*</td> <td style="padding: 5px;">T1</td> <td style="padding: 5px;">173</td> <td rowspan="2" style="padding: 5px; vertical-align: middle;">From left, EGH</td> </tr> <tr> <td style="padding: 5px;">D02</td> <td style="padding: 5px;"> </td> <td style="padding: 5px;">-0.00</td> </tr> <tr> <td style="padding: 5px;">DEPT. 02</td> <td style="padding: 5px;"> </td> <td style="padding: 5px;"> </td> <td></td> </tr> </table> <p style="text-align: center; margin-top: 5px;">Tax status Sign(F)</p>	*PGM*	T1	173	From left, EGH	D02		-0.00	DEPT. 02			
PGM	T1	173	From left, EGH									
D02		-0.00										
DEPT. 02												

■ Preset unit price

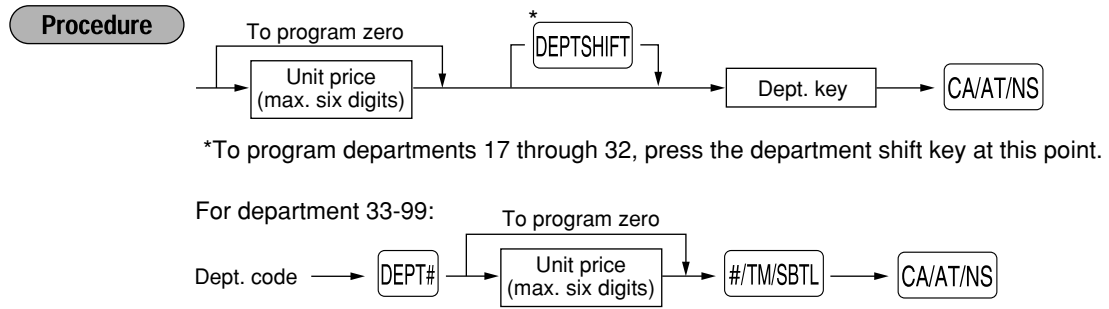

To program another department, start from the beginning without pressing the CA/AT/NS key.

Key operation example	Print											
1000 1 ¹⁷ CA/AT/NS	<table border="1" style="margin-left: auto; margin-right: auto;"> <tr> <td style="padding: 5px;">*PGM*</td> <td style="padding: 5px;">T1</td> <td style="padding: 5px;">073</td> <td rowspan="2" style="padding: 5px; vertical-align: middle;">Unit price</td> </tr> <tr> <td style="padding: 5px;">D01</td> <td style="padding: 5px;"> </td> <td style="padding: 5px;">10.00</td> </tr> <tr> <td style="padding: 5px;">DEPT. 01</td> <td style="padding: 5px;"> </td> <td style="padding: 5px;"> </td> <td></td> </tr> </table>	*PGM*	T1	073	Unit price	D01		10.00	DEPT. 01			
PGM	T1	073	Unit price									
D01		10.00										
DEPT. 01												

Note Even if a department is not programmed to allow the entry of preset unit prices in functional programming, the department is automatically changed to allow the entry of preset unit prices by this programming entry.

2 PLU (Price Look-Up) and Subdepartment Programming

The PLU function allows speedy key entries whereby a price is automatically called up when a code is entered. The subdepartment is a kind of “open PLU”, which requires you to enter a price after the PLU code is entered. A maximum of 1200 PLU/subdepartment settings are possible. Each one belongs to a department and acquires the department’s parameters (tax status, SICS and sign). The cash register is preprogrammed so all 1200 codes are assigned as PLUs associated with department 1 and preset unit price “0”.

■ Unit price and associated department assignment

Procedure

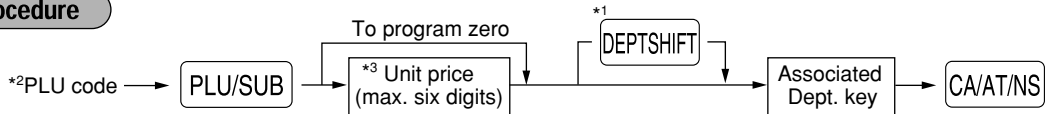

*1: To assign departments 17 through 32, press the department shift key at this point.

When the associated department is department 33-99:

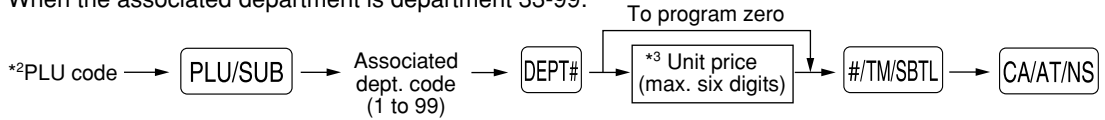

*2: 1 through 1200 (Depending on the EJ memory size setting, up to 200)

*3: For a subdepartment, set the limit amount of unit price entry.

To program the following PLU, start from entering a unit price or an associated department code without pressing the CA/AT/NS key.

To program another PLU, start from the beginning without pressing the CA/AT/NS key.

Key operation example

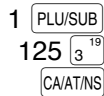

Print

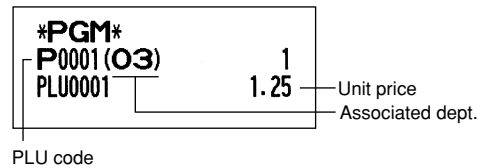

To delete a PLU code, use the following sequence:

Procedure

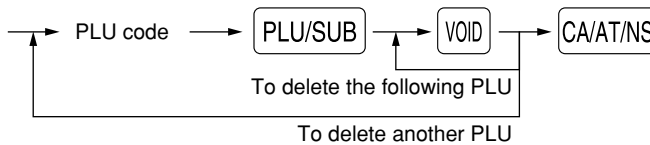

■ PLU/subdepartment selection

Procedure

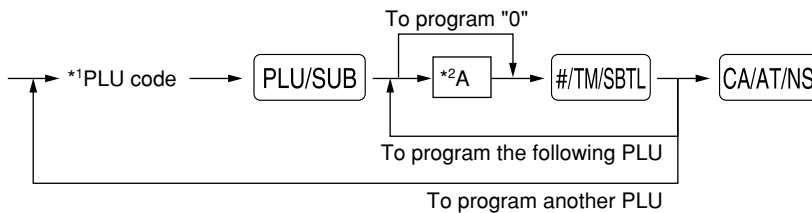

*1: 1 through 1200 (Depending on the EJ memory size setting, up to 200)

*2: 0 for subdepartment or 1 for PLU (default: 1)

Key operation example



Print

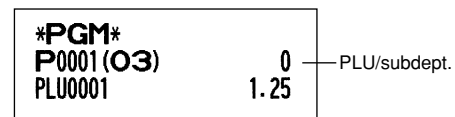

Note

When you program the last PLU code, the programming sequence will be complete with a press of the #/TM/SBTL key.

3 Miscellaneous Key Programming

The cash register provides miscellaneous keys such as **%1**, **%2**, **⊖**, **RFND**, **RA**, **RCPTPO**, **CONV**, **TAX**, **CHK**, **CH** and **CA/AT/NS**. While the cash register is pre-programmed so you can use these keys, you must set a currency conversion rate to use **CONV** key. You can also program these keys for more convenient use. Please refer to the data below for programming these keys. Factory setting is indicated with parentheses.

- %1**, **%2** Percent rate (0.00%), tax status (non-taxable), sign (minus), item % and subtotal % entry* (both are allowed), percent rate limitation (100 %)
- ⊖** Amount (0.00), tax status (non-taxable), sign (minus), item ⊖ and subtotal ⊖ entry* (both are allowed), entry digit limit (7 digits)
- RFND** Not necessary to program
- RA**, **RCPTPO** Entry digit limit (9 digits)
- CONV** Currency conversion rate (0.0000), currency conversion rate entry method - open or preset (both are enabled)
- CHK**, **CH** and **CA/AT/NS** Compulsory entry of amount tender (not compulsory), entry digit limit (8 digits), footer printing (not printed)
- TAX** (Manual tax) Entry digit limit (7 digits)

- * Item %/Item ⊖: Percent/discount calculation is applied to individual department and PLU/subdepartment.
- * Subtotal %/Subtotal ⊖: Percent/discount calculation is applied to subtotals.

■ Rate for **%1**, **%2** and **CONV**

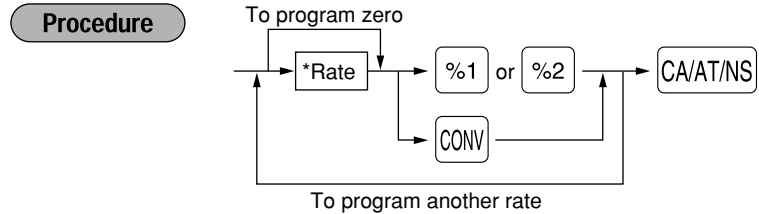

- *: Rate
- 0.00 — 100.00 (% rate)
- 0.0000 — 9999.9999 (Currency conversion rate)

Key operation example

10 • 25 **%1**
 0 • 7674 **CONV**
CA/AT/NS

Print

PGM		
F02 %1	000	
L100.00%	-10.25%	Percent rate
F48 CONV 1	00	
	0.7674	Currency conversion rate

Note You must use a decimal point when setting fractional rates.

■ Amount for ⊖

Procedure

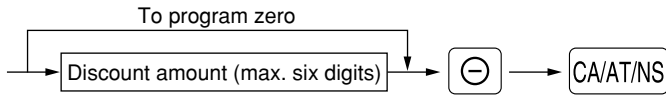

Key operation example

200 ⊖
CA/AT/NS

Print

```
*PGM*
F01 (-)           007
                  -2.00
                  |
                  |----- Discount amount
```

■ Percent rate limitation for %1 and %2

Procedure

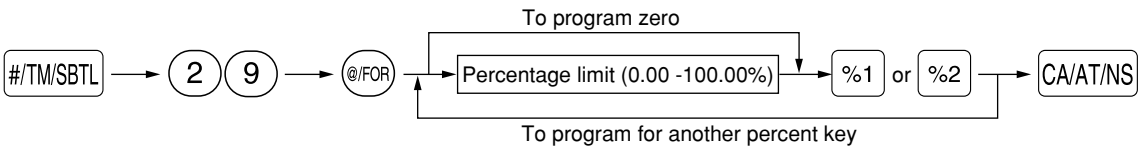

- Note**
- Percent entries that exceed the upper limit may be overridden in the MGR mode.
 - 10.00% can be entered as 1 0 or 1 0 • 0 0 . The • key is needed only for fractional entry.

Key operation example

#/TM/SBTL 29 @/FOR
15 • 00 %1
CA/AT/NS

Print

```
*PGM*
F02 %1           000
L 15.00%        -10.25%
                  |
                  |----- Percentage limit
```

■ Function parameters for %1, %2 and ⊖

Procedure

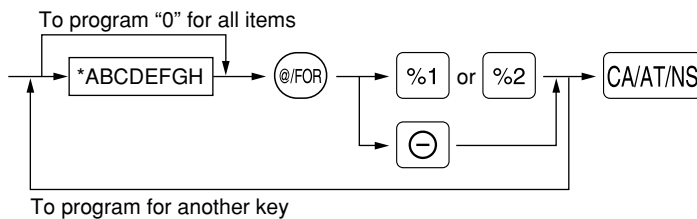

*: Item:	Selection:	Entry:
A Tax 4 status	Taxable	1
	Non-taxable*	0
B Tax 3 status	Taxable	1
	Non-taxable*	0
C Tax 2 status	Taxable	1
	Non-taxable*	0
D Tax 1 status	Taxable	1
	Non-taxable*	0
E +/- sign	+ (premium) sign	0
	- (discount) sign*	1
F Item % / Item ⊖	Allow*	0
	Disallow	1
G Subtotal % / Subtotal ⊖	Allow*	0
	Disallow	1
H Entry digit limit for discount key		0-7 (default: 7)

When programming for percent keys, always enter 0 for H.

Tax status (taxable 1 through 4 / non-taxable)

- When taxable is selected, tax is applied to the amount obtained after premium or discount calculation.



+/- sign

- Programming of the +/- sign assigns the premium or discount function for each key.

Entry digit limit (For discount key only)

- The entry digit limit is in effect for the REG mode operations but can be overridden in the MGR mode. The entry digit limit is represented by the number of allowable digit for the maximum entry amount for discount key.

Key operation example

00011006 
 CA/AT/NS

Print

```
*PGM*
F01 (-)      006
             -2.00
             |
             |1
             |
             Tax status
```

From left, FGH
Sign(E)

Function parameters for

Procedure

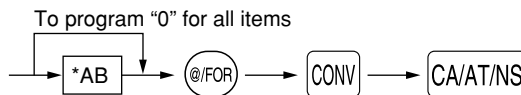

*: Item:	Selection:	Entry:
A Open rate entry	Allow*	0
	Disallow	1
B Preset rate entry	Allow*	0
	Disallow	1

Key operation example

00 
 CA/AT/NS

Print

```
*PGM*
F48 CONV 1      00
                0.7674
```

From left, AB

■ Entry digit limit for **RA**, **RCPT/PO** and **TAX**

Procedure

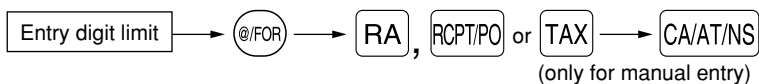

- For **RA** **RCPT/PO**, enter 0 to 9 (digits), and for **TAX** (manual tax), enter 0 to 7 (digits). By default, 9 for **RA** and **RCPT/PO** and 7 for **TAX** are set.

Entry digit limit is in effect for REG mode operation but can be overridden in the MGR mode. The entry digit limit is represented by the number of allowable digits for maximum entry or total amount. When "0" is set, the operation of the corresponding key is prohibited.

Key operation example

4 **@/FOR**
RCPT/PO **CA/AT/NS**

Print

```
*PGM*
F41 ***P0      4
```

■ Function parameters for **CHK**, **CH** and **CA/AT/NS** (when using as CA key)

Procedure

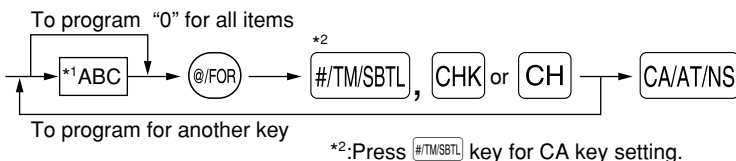

*1:Item:	Selection:	Entry:
A Footer printing	Allow	1
	Disallow*	0
B Amount tendered entry	Compulsory	1
	Non-compulsory (for the CA or CHK keys)*	0
	Inhibit (for the CH key)*	0
C Entry digit limit		0-8 (default: 8)

Footer printing

- This programming decides whether or not the machine should print a message at the foot of a receipt when a specified media key is used. With regard to programming method of footer logo message, refer to "Logo messages" section on [page 43](#).

Amount tendered entry

- You may select amount tendered, compulsory or optional, for the **CA/AT/NS** and **CHK** keys.
- You may select amount tendered, compulsory or inhibited, for the **CH** key.

Entry digit limit

- For the **CH** and **CHK** keys, program upper limit entry amount for the tendered amount. For the **CA/AT/NS** key, program upper limit entry for total cash amount which can be handled on the register. The entry digit limit is in effect for REG mode operation but can be overridden in the MGR mode. The entry digit limit is represented by the number of allowable digits for the maximum entry or total amount. When "0" is set, the operation of the corresponding key is prohibited.

Key operation example

018 **@/FOR**
CHK **CA/AT/NS**

Print

```
*PGM*
F45 CHECK
00000000018
```

ABC (A:0, B:1, C:8)

4 Text Programming

The register allows you to program the text for clerk names, department item names, PLU/subdepartment item names, and so on, if necessary. There are two ways for programming text: using character keys on the keyboard or entering character codes with numeric keys on the keyboard.

Using character keys on the keyboard

You can enter characters according to the small figures printed in the lower right position of the key tops. For the layout, please refer to “Keyboard” section on [page 5](#).

The following are used as control keys for character entry:

- SHIFT** Toggles between upper-case and lower-case letters. By default, the upper-case letter is selected. Once the **SHIFT** key is pressed, you are locked in for entering lower-case letters. “_” lights up at the SHIFT position of the display when lower-case letters entry is selected.
- NUMBER** Press the **NUMBER** key to enter numeric characters. For example to enter “1”, press the **NUMBER** and **1** key. If you press the **1** key without pressing the **NUMBER** key, the cash register goes to character codes entry mode. Once the **NUMBER** key is pressed, you are locked in for entering numeric characters. “_” lights up at the NUMBER position of the display when numeric characters entry is selected.
- DC** Toggles between single-size and double-size characters. By default, the single-size character is selected. Once the **DC** key is pressed, you are locked in for entering double size characters. “_” lights up at the DC position of the display when double-size characters entry is selected.
- BS** Backs up the cursor, erasing the character to the left.

Example

To program the word “Clerk01” with the letter “C” being double size.

To make the letter “C” double size character	DC C
To make character size return to normal size	DC
To toggle the characters to lower-case letters	SHIFT
	L E R K
To enter numbers	NUMBER 0 1

Entering character codes with numeric keys on the keyboard

Numerals, letters and symbols are programmable by entering the character code and the **00** key. (If numeric characters entry is selected, that is, “_” lights up at the NUMBER position of the display, press the **NUMBER** key to release it.) Set the alphanumeric character code table on the next page. By doing this, you can program characters other than those on the key tops.

- Double-size characters can be made by entering the character code 253.
- All three digits of the character code MUST be entered (even if it starts with zero).

Example

To program the word “SHARP” in double-size characters

253 **00** 083 **00** 072 **00** 065 **00** 082 **00** 080 **00**

S H A R P

When you press an appropriate number key (job code number) and press the **0** key for text entry just after you start programming with the **#TMSBTL** key, the cash register will be automatically ready for text entry.

Listed below is an overview of what you can program and the allowable number of single sized characters for each text entry.

- Department text 12 characters
- PLU text (item label) 12 characters
- Function text 8 characters
- Logo message 6 lines and 24 characters for each line
- Clerk name 8 characters
- Foreign currency symbol 4 characters

Alphanumeric character code table

Code	Character	Code	Character	Code	Character	Code	Character	Code	Character
001	á	046	.	091	Ä	136	→	193	ı
002	â	047	/	092	Ö	137	ƒ	194	Ġ
003	ê	048	0	093	Ü	138	Œ	195	Ş
004	î	049	1	094	^	139	◀	196	Ğ
005	ì	050	2	095	_	140	▶	197	ġ
006	í	051	3	096	‘	141	F	198	Ƙ
007	ô	052	4	097	a	142	τ	199	ƙ
008	ó	053	5	098	b	143	↓	200	Ł
009	û	054	6	099	c	144	ç	201	Ј
010	ú	055	7	100	d	145	°	202	Ž
011	œ	056	8	101	e	146	ı	203	Đ
012	ů	057	9	102	f	147	ù	204	đ
013	ú	058	:	103	g	148	à	205	Ć
014	ø	059	;	104	h	149	Æ	206	ć
015	ó	060	<	105	i	150	ø	207	€
016	Λ	061	=	106	j	151	Å	208	Ɔ
017	Ψ	062	>	107	k	152	□	209	˘
018	Γ	063	?	108	l	153	é	210	ě
019	˘	064	@	109	m	154	è	211	š
020	Ω	065	A	110	n	155	Pt	212	č
021	Δ	066	B	111	o	156	i	213	ž
022	Θ	067	C	112	p	157	Ñ	214	ý
023	Ξ	068	D	113	q	158	ò	215	ù
024	Π	069	E	114	r	159	£	216	ň
025	Σ	070	F	115	s	160	¥	217	˘
026	Υ	071	G	116	t	161	◦	218	˘
027	Φ	072	H	117	u	162	Γ	219	ř
028	Ú	073	I	118	v	163	┘	224	*
029	Ú	074	J	119	w	164	˘	225	§
030	Ů	075	K	120	x	165	.	226	Ø
031	Ó	076	L	121	y	177	Á	227	ˆ
032	(space)	077	M	122	z	178	í	228	↑
033	!	078	N	123	{	180	Ā	229]
034	”	079	O	124		181	ā	230	[
035	#	080	P	125	}	182	Ē	231	“
036	\$	081	Q	126	β	183	ē	232	ä
037	%	082	R	127	¢	184	Ī	233	ö
038	&	083	S	128	!!	185	ī	234	ü
039	,	084	T	129	₁	186	Ū	235	æ
040	(085	U	130	₂	187	ū	236	â
041)	086	V	131	₃	188	Ŋ	237	É
042	*	087	W	132	₄	189	ŋ	238	ñ
043	+	088	X	133	1/2	190	Č	253	*(DC)
044	,	089	Y	134	Fₜ	191	Š		
045	-	090	Z	135	←	192	Č		

*(DC): Double-size character code

: The shaded character cannot be displayed (displayed as space).

Note The character “!!” (code 128) cannot be displayed (displayed as “!”).

■ Department text

Procedure

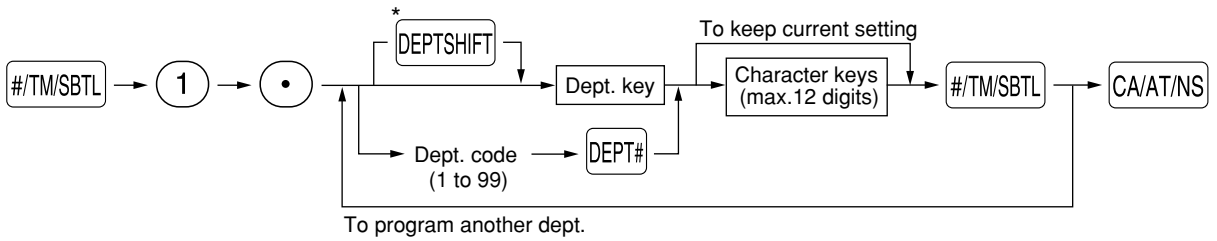

*To program departments 17 through 32, press the department shift key.

Key operation example

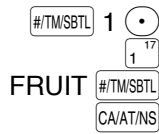

(Programming FRUIT for dept.1)

Print

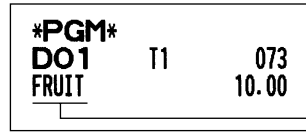

Text programmed for dept. 1

■ PLU text (item label)

Procedure

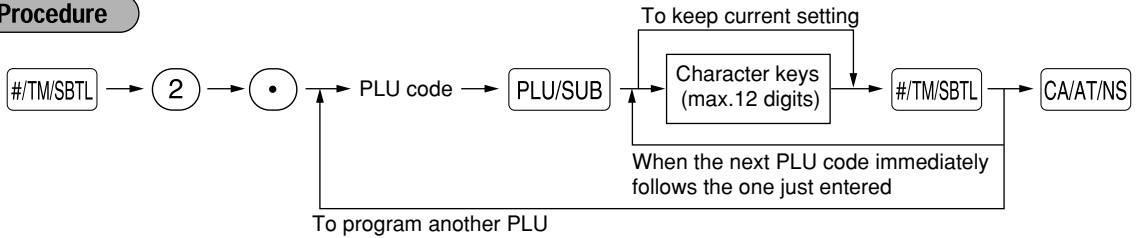

Key operation example



(Programming MELON to PLU1)

Print

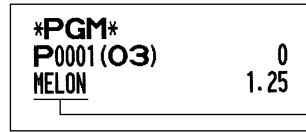

Text programmed for PLU code 1

■ Function text

Procedure

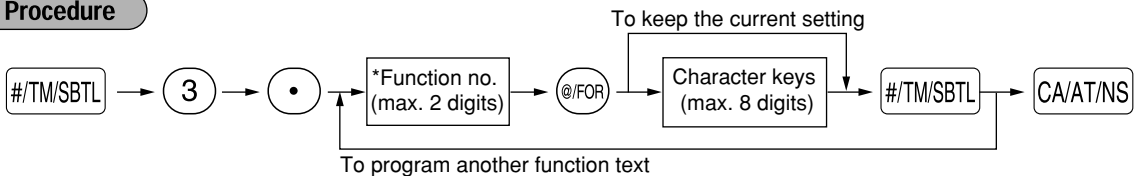

* Function no.: See "List of function texts" shown on the following page.

Key operation example

#TMSBTL 3
 46 @FOR
 CARD #TMSBTL
 CA/AT/NS

Print

PGM
 F46 CARD
 000000000008

(Programming CARD for gross charge)

■ List of function texts

Function no.	Key or function	Default setting	Function no.	Key or function	Default setting
1	⊖	(-)	36	Void mode	VOID
2	%1	%1	37	Manager void	MGR VD
3	%2	%2	38	Subtotal void	SBTL VD
4	Net sales total	NET1	39	No sale	NO SALE
5	Net taxable 1 subtotal	TAX1 ST	40	RA	***RA
6	Gross tax 1 total	GRS TAX1	41	PO	***PO
7	Tax 1 total of refund entries	RFD TAX1	42	Customer counter	TRANS CT
8	Net tax 1 total	TAX1	43	Sales total	NET 3
9	Exempt tax 1	TX1 EXPT	44	Cash	CASH
10	Net taxable 2 subtotal	TAX2 ST	45	Check	CHECK
11	Gross tax 2 total	GRS TAX2	46	Gross charge	CHARGE
12	Tax 2 total of refund entries	RFD TAX2	47	Refund charge	CHARGE-
13	Net tax 2 total	TAX2	48	Currency conversion1 (Preset)	CONV 1
14	Exempt tax 2	TX2 EXPT	49	Currency conversion2 (Open)	CONV 2
15	Net taxable 3 subtotal	TAX3 ST	50	Cash in drawer	**** CID
16	Gross tax 3 total	GRS TAX3	51	Cash+check in drawer	CA+CH ID
17	Tax 3 total of refund entries	RFD TAX3	52	Check change	CHK/CG
18	Net tax 3 total	TAX3	53	Exempt VAT	VAT EXPT
19	Exempt tax 3	TX3 EXPT	54	(+)Dept. total	*DEPT TL
20	Net taxable 4 subtotal	TAX4 ST	55	(-)Dept. total	DEPT(-)
21	Gross tax 4 total	GRS TAX4	56	Subtotal	SUBTOTAL
22	Tax 4 total of refund entries	RFD TAX4	57	Merchandise subtotal	MDSE ST
23	Net tax 4 total	TAX4	58	Total	*** TOTAL
24	Exempt tax 4	TX4 EXPT	59	Change	CHANGE
25	Gross manual tax total	GRS MTAX	60	Items	ITEMS
26	Refund manual tax total	RFD MTAX	61	Department report title	DEPT
27	Net manual tax total	M-TAX	62	PLU report title	PLU
* 28	Exempt total from GST	GST EXPT	63	Transaction report title	TRANS.
* 29	PST total	PST TTL	64	Clerk report title	CLERK
* 30	GST total	GST TTL	65	Hourly report title	HOURLY
31	Tax total	TTL TAX	66	Non add symbol	#
32	Net	NET	67	Copy receipt title	COPY
33	Sales total including tax total	NET2	68	EJ report title	EJ
34	Refund	REFUND	69	EJ report end title	EJ END
35	Item void	VOID			

Note

- The items marked with “*” are for Canada only.
- The function no. 53 “Exempt VAT” is only effective for the Canadian tax system (2 GST, VAT type).

■ Clerk names

Procedure

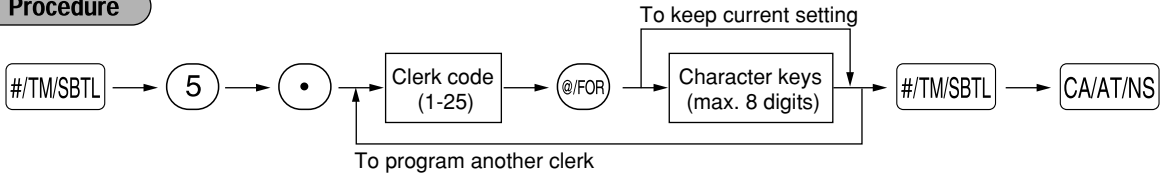

Key operation example

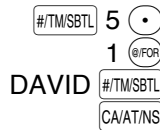

Print



■ Logo messages

The register can print programmed messages on every receipt. On the standard model, the graphic logo is printed on the receipt. If you want to print logo messages, please change the logo message print format. (See [page 51](#) for the programming details.) The options are listed below:

Procedure

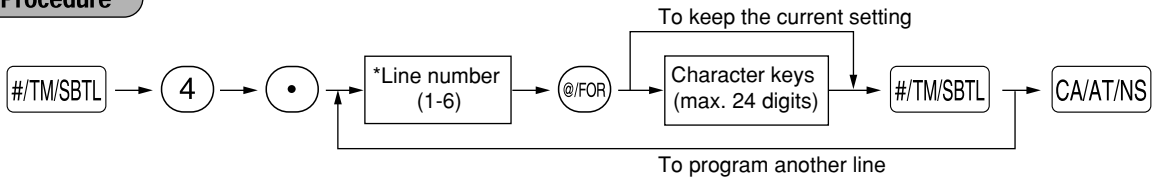

- * "Header 3-line message" type: 1 to 3
- "Footer 3-line message" type : 4 to 6
- "Header 6-line message" type: 1 to 6
- "Header 3-line and footer 3-line message" type: 1 to 6 (1 to 3 as header, 4 to 6 as footer)

Logo print format (6 types)

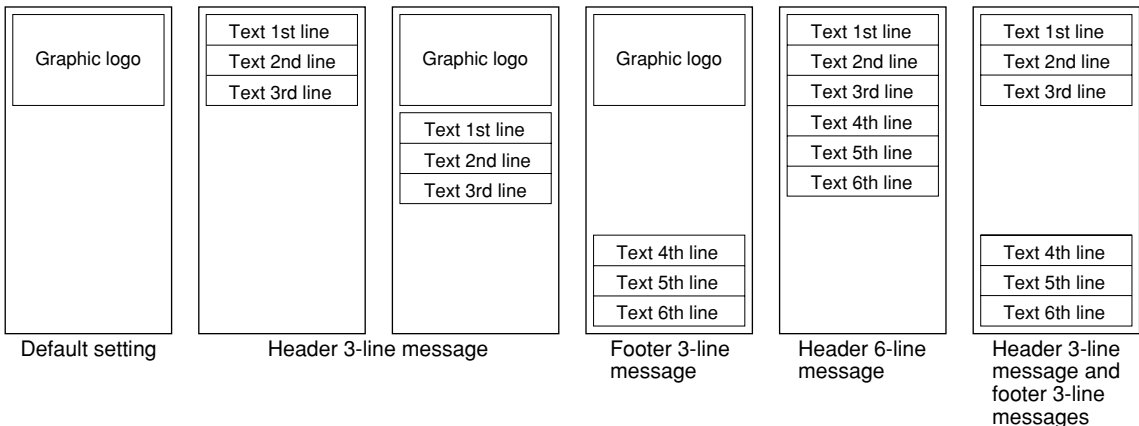

To print the logo message “THANK YOU” using double sized characters and centering on the third line.

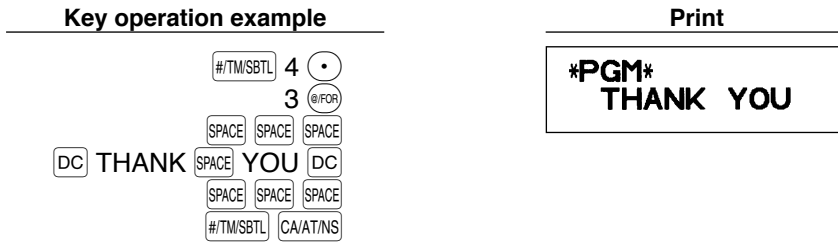

Note A 6-line logo message is preprogrammed when shipped. Please start entering from the first line when you first program a logo message.

Foreign currency symbol

Foreign currency symbol for **CONV** key is printed with a foreign currency exchange amount.

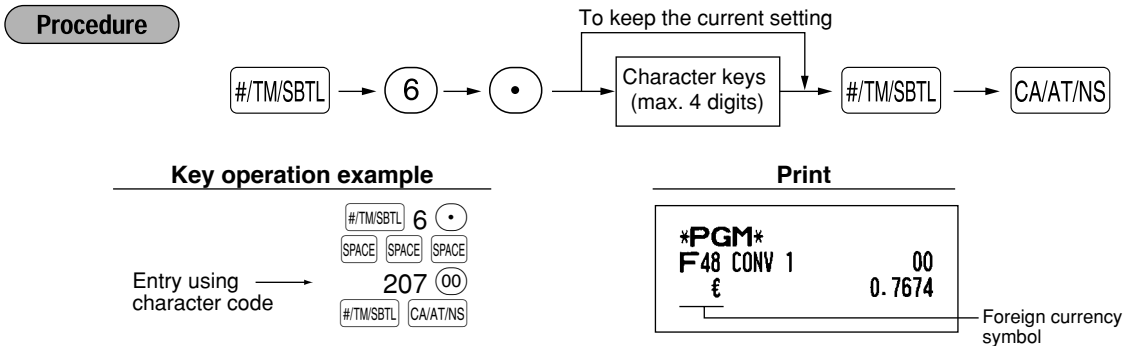

ADVANCED PROGRAMMING

1 Register Number and Consecutive Number Programming

The register number and consecutive numbers are printed on every receipt or journal. When your store has two or more registers, it is practical to set separate register numbers for their identification. The consecutive number is increased by one each time a receipt is issued or when a journal print occurs. For consecutive number programming, enter a number (max. 4 digits) that is one less than the desired starting number.

Register number

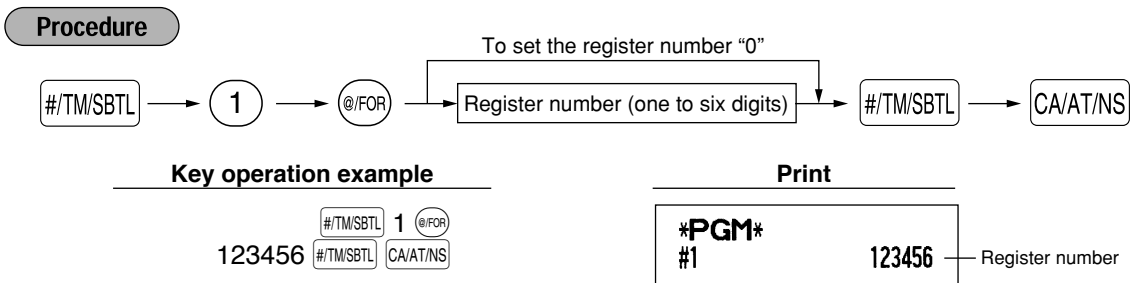

■ Consecutive numbers

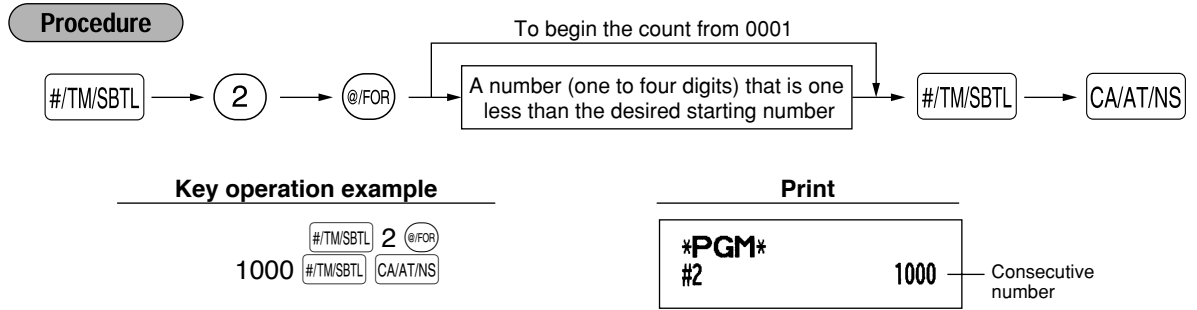

2 Electronic Journal (EJ) Programming

The cash register provides the electronic journal (EJ) function. By default, a maximum of 2000 lines can be stored in memory. If you want to store more journal data, you can expand to a maximum of 3000 lines, although the maximum number of PLUs is decreased to 200 codes because the memory is shared with PLU settings.

You can also program various options for EJ, such as availability of EJ memory nearly full warning, availability of printing EJ data during a transaction, data type to be stored in memory, and printing format.

For reading journal data, refer to “EJ REPORT READING AND RESETTING” (page 60).

■ EJ memory type

Caution When this procedure is executed, EJ data is cleared, and PLU data (programming data and sales data) are reset to the default after all data is cleared even if the same memory type is selected.

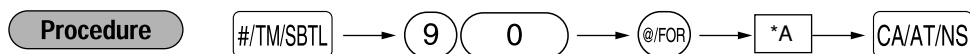

*A: 0 for EJ 2000 lines and PLU 1200 codes (default)
1 for EJ 3000 lines and PLU 200 codes



■ Function parameters for EJ

Procedure

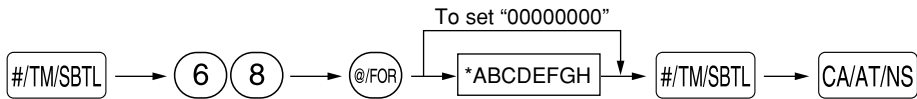

* Item:	Selection:	Entry:
A	Always enter 0. (Fixed position)	0
B	Always enter 0. (Fixed position)	0
C	Temporary EJ printing during a transaction	Disallow
		Allow*
D	EJ printing and clearing EJ data when issuing general Z1 report	No*
		Yes
E	PGM mode operation records type	Details*
		Header information only
F	REG/MGR/VOID modes operation records type	Details*
		Total
G	Compressing printing for EJ data	No (normal size)
		Yes (small size)*
H	Action when EJ memory area is full	Continue
		Warning (near full warning)*
		Lock (with near full warning)

On the default setting, an asterisk is marked.

Temporary EJ printing during a transaction

- If selecting "yes", you can print journal data of a current transaction recorded in EJ memory by pressing the **RCPT/PO** key during the transaction. To realize this function completely, the cash register is programmed to receipt printing and set Receipt ON/OFF function to OFF.

PGM mode operation records type

- The header information only is printed during the program reading operation. The header information only is printed for X/Z reports.
(Receipt sample for Header Information only)

```

08/26/2005  3:22PM  01
123456#1004  DAVID
**X1**
**DEPT**
** TRANS. **
  
```

Action when EJ memory area is full

- By default, when the memory for EJ becomes nearly full, the cash register shows decimal points at the 8th and 9th positions of the display (EJ memory nearly full message), and the cash register keeps storing new data while erasing the oldest data. When "0" is selected, the cash register will no longer show EJ memory nearly full message. When "2" is selected, the cash register shows EJ memory nearly full message and when the memory is totally full, the cash register locks the sales/data entry with a display of the memory full message "E-E". You will only be able to issue an EJ report.

Key operation example

```

00100002  #/TM/SBTL 68 @/FOR
           #/TM/SBTL CA/AT/NS
  
```

Print

```

*PGM*
#68  00100002
  
```



3 Various Function Selection Programming 1

The cash register provides various detailed functions listed below.

- Function selection for miscellaneous keys
- Print format
- Receipt print format
- Function selection for tax
- Others

For this programming, job code entry style is applied. You can continue programming until you press the **CA/AT/NS** key for the programming described in this section. To continue programming, repeat from a job code entry.

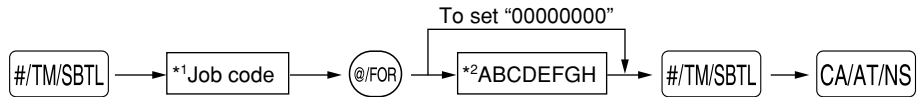
Procedure



*1 Enter job code using numeric keys specified in each section below.

*2 Data entry details are listed on each table in each section below.

Example: When programming for job code 5 as ABCDEFGH: 00000100.

Key operation example

00000100 **#/TM/SBTL** **5** **@/FOR**
#/TM/SBTL **CA/AT/NS**

Print

PGM
#5 00000100

Function selection for miscellaneous keys

Job code: 5

* Item:	Selection:	Entry:
A PO in REG mode	Allow the PO operation in REG mode*	0
	Disallow it	1
B RA in REG mode	Allow the RA operation in REG mode*	0
	Disallow it	1
C Subtotal void in REG mode	Allow the REG mode subtotal void*	0
	Disallow it	1
D Indirect void in REG mode	Allow the REG mode indirect void*	0
	Disallow it	1
E Direct void in REG mode	Allow the REG mode direct void*	0
	Disallow it	1
F Refund key availability	Allow the REG mode refund entry*	0
	Disallow it	1
G No sale in REG mode	Allow the no sale operation in REG mode*	0
	Disallow it	1
H Fractional quantity availability	Allow fractional quantity entry	0
	Disallow it*	1

■ Print format

Job code: 6

* Item:	Selection:	Entry:	
A	Printing style	Use the printer for journal printing	0
		Use the printer for receipt printing*	1
B	Receipt print format	Total	0
		Detailed*	1
C	Time print on all receipts/journals	Allow time printing*	0
		Disallow it	1
D	Date print on all receipts/journals	Allow date printing*	0
		Disallow it	1
E	Consecutive no. print on all receipts/journals	Allow consecutive no. printing*	0
		Disallow it	1
F	Always enter 0.	(Fixed position)	0
G	Zero skip for PLU report	Disallow zero skip	0
		Allow zero skip*	1
H	Zero skip for general, clerk and hourly reports	Disallow zero skip	0
		Allow zero skip*	1

Printing style

- Even when receipt printing is selected, the journal rewind motor will be driven in PGM, OP X/Z, X1/Z1 and X2/Z2 modes so you can wind sales and programming reports.

■ Receipt print format

Job code: 7

* Item:	Selection:	Entry:	
A	Always enter 0.	(Fixed position)	0
B	Always enter 0.	(Fixed position)	0
C	Subtotal print with a press of subtotal key	Disallow subtotal printing*	0
		Allow it	1
D	Merchandise print with a press of merchandise subtotal key	Disallow merchandise subtotal printing*	0
		Allow it	1
E	Always enter 0.	(Fixed position)	0
F	Always enter 0.	(Fixed position)	0
G	Always enter 0.	(Fixed position)	0
H	Number of purchases print	Allow printing of number of purchases*	0
		Disallow it	1

■ Function selection for tax

Job code: 15

* Item:	Selection:	Entry:	
A to F	Always enter 0.	(Fixed position)	0
G	Tax delete in REG mode availability	Allow tax delete in REG mode*	0
		Disallow it	1
H	Manual tax entry in REG mode availability	Allow manual tax entry in REG mode*	0
		Disallow it	1

■ Other programming

Job code: 61

* Item:	Selection:	Entry:
A	Always enter 0. (Fixed position)	0
B	Always enter 0. (Fixed position)	0
C	Minus dept. and PLU/subdept. availability	Disallow to program minus dept. and PLU/subdept. 0 Allow it* 1
D	Fractional treatment	Round off (4 down, 5 up)* 0 Raising to unit 1 Disregarding fractional treatment 2
E	Use of (00) key	Use (00) key as 00 key* 0 Use (00) key as 000 key 1
F	Time format	Use 12-hour format* 0 Use 24-hour format 1
G	Date format	Use month-day-year format* 0 Use day-month-year format 1 Use year-month-day format 2
H	Position of decimal point (from right) (TAB)	0 to 3 (default 2)

Job code: 62

* Item:	Selection:	Entry:
A	Always enter 0. (Fixed position)	0
B	Error beep activation	By lock error* 0 By misoperation 1
C	Key touch sound availability	Allow to sound* 0 Disallow it 1
D	Buffered keyboard	Yes* 0 No 1
E	Void mode operation availability	Allow void mode operation* 0 Disallow it 1
F	Void mode entry data print in Z2 reports	Allow printing of void mode entry data in Z2 reports* 0 Disallow it 1
G	Void mode entry data print in Z1 reports	Allow printing of void mode entry data in Z1 reports* 0 Disallow it 1
H	Addition of hourly sales total data in void mode	No* 0 Yes 1

Job code: 66

* Item:	Selection:	Entry:
A	Printing a receipt after transaction	Total only 0 Details* 1
B	Amount printing when PLU/subdept. unit price is zero	Disallow printing* 0 Allow it 1
C	Subtotal printing for conversion of deficit	Allow printing* 0 Disallow it 1
D	Always enter 0. (Fixed position)	0
E	Compression printing on journals in PGM, OP X/Z, X1/Z1 and X2/Z2 modes	Disallow compression printing (normal size) 0 Allow compression printing (small size)* 1
F	Compression printing on journals in REG, MGR and VOID modes	Disallow compression printing (normal size) 0 Allow compression printing (small size)* 1
G	Logo message printing on journals	Disallow logo message printing on journals* 0 Allow logo message printing on journals 1
H	Footer printing	Printing footer on all receipts* 0 Printing footer with selected function key at the time of finalization 1

Compression printing

- This programming is valid only when journal printing is selected. This does not affect EJ printing. (For EJ programming, please refer to [page 46](#).)

Job code: 70

* Item:	Selection:	Entry:
A	Split pricing counting	Quantity*
		Package
B	Multiplication/split pricing entry availability	Allow multiplication entry only*
		Allow both of multiplication and split pricing
C	Always enter 0.	(Fixed position)
D	Always enter 0.	(Fixed position)
E	Tax printing when GST is VAT	Allow tax printing*
		Disallow it
F	GST exempt printing on X/Z reports	Allow printing of GST exempt*
		Disallow it
GH	Tax calculation system	Auto tax*
		Canadian tax (tax type number)

Tax calculation system

- For US tax system, select “auto-tax”.
- For Canadian tax, from the table below, specify a tax system suitable for your province (if necessary contact your local tax office for correct sales tax information) and for your type of retail business. In the cash register, four kinds of tax can be set and each tax is arranged to match GST or PST as follows:

Tax 1: PST Tax 2: PST
 Tax 3: PST or GST Tax 4: GST

Canadian tax type number	Tax 4 method	Tax 3 method		Tax 2 and 1 method
	GST	GST	PST	PST
01	VAT	VAT	-	Tax on tax
02	VAT	VAT	-	Tax on base
03	VAT	-	Tax on tax	Tax on tax
04	VAT	-	Tax on base	Tax on base
05	Add on Tax	-	Tax on tax	Tax on Tax
06	Add on Tax	-	Tax on base	Tax on base
07	Add on Tax	VAT	-	Tax on tax
08	Add on Tax	VAT	-	Tax on base
09	Add on Tax	Add on Tax	-	Tax on tax
10	Add on Tax	Add on Tax	-	Tax on base
11	VAT	-	VAT (Tax on base)	Tax on tax

(The most common type for Canada is type number 06.)

Note

- To program a GST, use Tax 4; and to program two GSTs, use Tax 3 and 4. To program a PST, use Tax 1; to program two PSTs, use Tax 1 and 2; and to program three PSTs, use Tax 1, 2 and 3.
- The entry of a multi-taxable item for PST or GST is prohibited as follows for the Canadian tax system. When programming for departments, avoid programming the prohibited multi-taxable status.

In case of; Tax 1: PST, Tax 2: PST,
 Tax 3: PST, Tax 4: GST

Taxable 1 and 2 item prohibited
 Taxable 1 and 3 item prohibited
 Taxable 2 and 3 item prohibited
 Taxable 1 and 4 item allowed
 Taxable 2 and 4 item allowed
 Taxable 3 and 4 item allowed

In case of; Tax 1: PST, Tax 2: PST,
 Tax 3: GST, Tax 4: GST

Taxable 1 and 2 item prohibited
 Taxable 1 and 3 item allowed
 Taxable 2 and 3 item allowed
 Taxable 1 and 4 item allowed
 Taxable 2 and 4 item allowed
 Taxable 3 and 4 item prohibited

4 Various Function Selection Programming 2

The cash register provides various options so you can use the register to suit your sales needs.

In this section, you can program the following features (parameters within parentheses indicates default setting):

- Power save mode (entering the power save mode in 30 minutes)
- Logo message print format (graphic logo only)
- Thermal printer density (standard density)
- Online time out setting
- Language selection (English)
- Training clerk specification (none) - If you specify a clerk code who is trained for use on this cash register, the cash register will go into training mode when the clerk code is registered for sales entries. The sales operations done by the trained clerk does not affect sales total. For details, refer to TRAINING MODE section.

Power save mode

Procedure

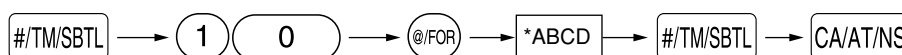

* Item:	Selection:	Entry:
A Entering power save mode when time is displayed	Yes*	0
	No	1
B-D Time(min.) to entering power save mode since no operation is made		001-254 or 999 (Default 030)

Note

When 999 is set for B to D, entering into power save mode is inhibited.

Key operation example



Print

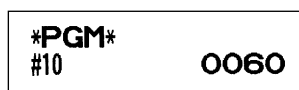

Logo message print format

You can select the number of lines for your logo message, and the position to print it on receipt or journal.

Procedure

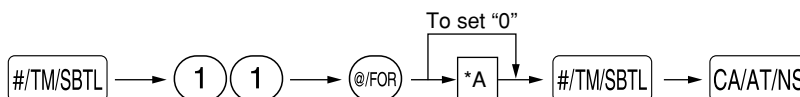

*A: Logo message type

- 0: Header 3-line message without graphic logo
- 1: Graphic logo only (default)
- 2: Footer 3-line message with graphic logo
- 3: Header 6-line message
- 4: Header 3-line message with graphic logo
- 5: Header 3-line message and footer 3-line message

Key operation example



Print

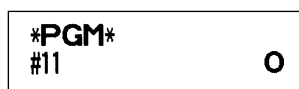

■ Online time out setting

Procedure

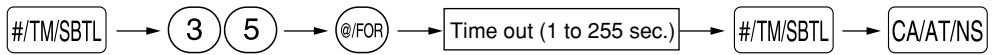

Default: 007

Key operation example



Print

```

    *PGM*
    #35           030
  
```

■ Thermal printer density

Procedure

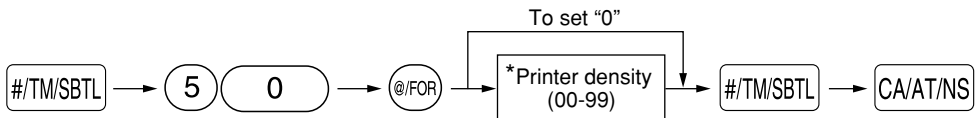

* 50 is the default setting. To make the print darker, set a larger number, and to make the print lighter, set a smaller number.

Key operation example



Print

```

    *PGM*
    #50           00
  
```

■ Language selection

Procedure

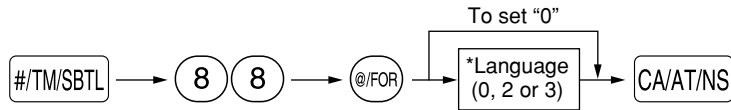

*Language: 0: English 2: French 3: Spanish (default: English)

Key operation example

```

    #/TM/SBTL 88 @/FOR
    2 CA/AT/NS
  
```

Print

```

    *PGM*
    #88      2
  
```

Caution

When you change the language, the texts such as clerk names, logo messages and function texts (refer to [page 42](#)), which you programmed, will be reset to the default settings. The language selection must be made before programming clerk names, logo messages and function texts.

■ Training clerk specification for training mode

For the details of clerk training, please refer to “TRAINING MODE” on [page 56](#).

Procedure

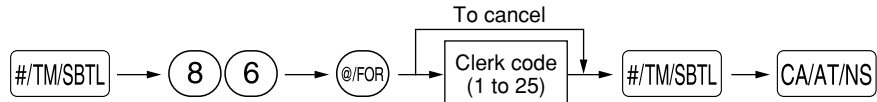

Key operation example

```

    #/TM/SBTL 86 @/FOR
    25 #/TM/SBTL CA/AT/NS
  
```

Print

```

    *PGM*
    #86      25
  
```

■ AUTO key programming — Automatic sequence key —

If you program frequently performed transactions or report sequences for the **AUTO** key, you can recall those transactions and/or reports simply by pressing the **AUTO** key in key operations.

Procedure

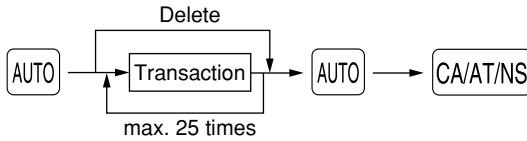

Programming for **AUTO**; entering a PLU 2 item (programmed unit price: 1.50) and a dept. 6 item (unit price: 1.00)

Key operation example

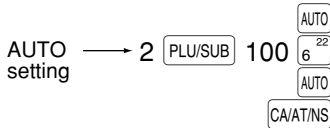

Print

```

*PGM*
#01

2
PLU/SB
1
0
0
DO6
  
```

Note

When the **AUTO** key has been programmed to execute a report job function, the mode switch must be in the appropriate position (OPX/Z for individual clerk reports, X1/Z1 for daily reports or X2/Z2 for weekly or monthly reports).

5 Reading Stored Programs

The machine allows you to read every program stored in the PGM mode.

■ Key sequence for reading stored program

Report name	Key sequence
Programming report 1	CA/AT/NS
Programming report 2	2 → CA/AT/NS
Auto key programming report	1 → CA/AT/NS
Printer density programming report	3 → CA/AT/NS
PLU programming report	Start PLU code → @/FOR → End PLU code → PLU/SUB

Note

- To stop reading programming report 1 or PLU programming report, turn the mode switch to the MGR position.
- When printing is performed continuously, the printing may be intermitted several seconds. After the intermission, the printing will be restarted.

Sample printouts

1 Programming report 1

PGM			Mode
D01	T1	073	Dept. code
FRUIT			Dept. text
D02	T1	10.00	Dept. unit price w/sign
DEPT.02		173	Dept. function
D03	T1	-13.10	Minus department
DEPT.03		071	
		0.00	Tax status
D99		071	Function no.& its text
DEPT.99		0.00	Tax status
F01 (-)		006	Function parametrs (F-H)
	T1	-2.00	Discount amt. w/sign
F02 %1		000	Function parametrs (F-H)
L 15.00%		-10.25%	Percent rate with sign
F03 %2		000	
L100.00%		-0.00%	Percent limit
F04 NET1			
F05 TAX1 ST			
F26 RFD MTAX			
F27 M-TAX	7		Entry digit limit
F28 GST EXPT			
F39 NO SALE			
F40 ***RA	9		Entry digit limit
F41 ***PO	4		Entry digit limit
F42 TRANS CT			
F43 NET3			
F44 CASH		000000000008	
F45 CHECK		000000000018	
F46 CHARGE		000000000008	Function parameters (A-C)
F47 CHARGE-			
F48 CONV 1		00	Function parameters
£		0.7674	Foreign currency symbol/Rate
F49 CONV 2			
F50 ***CID			

F68 EJ			
F69 EJ END			
SHARP PRESENTS THE XE-A20S SHARP IS THE BEST			
#5	00000100		Function selection for miscellaneous keys (A-H)
#6	11000011		Print format (A-H)
#7	00000000		Receipt print format(A-H)
#10	0060		Power save mode(A-D)
#11	3		Logo message print format
#15	00000000		Function selection for tax (A-H)
#19	00		Doughnut tax exempt
#35	007		Online time out
#50	99		Thermal printer density
T1	6.0000%		
	/ 1.00		
	1	0.11	
	2	0.23	
	3	0.39	
	4	0.57	
	5	0.73	
	6	0.89	
	7	1.11	
T2	4.0000%		Tax rate
	0.12		Min. taxable amount
T3	-----		
T4	-----		
C#01	DAVID		Clerk code/name
C#02	CLERK02		
C#24	CLERK24		
C#25	CLERK25		

2 Programming report 2

PGM		
#61	00100002	Job code
#62	00000000	
#63	01000001	A to H from the left
#64	00000000	
#65	00000000	* Job code #63, 64, 65, 67, 69, 71, 72, 76, 77, 85, 87 and 95 are fixed settings, for which you cannot change the settings.
#66	10001100	
#67	00000000	
#68	00100002	
#69	00000000	
#70	00000000	
#71		
GT2	\$0000000000.00	
#72		
GT3	\$0000000000.00	
#76	Z1 0000	
#77	Z2 0000	
#85	\$	
#86	25	Training clerk specification
#87	TRAINING	
#88	0	Language selection
#90	1	EJ memory type
#95	99	

3 Auto key programming report

PGM	
#01	
	2
	PLU/SB
	1
	0
	0
	D06

4 Printer density programming report

PGM		Entered Value
#50		Printer density
	50	
10	: 0123456789AB	Printing density example
20	: 0123456789AB	
30	: 0123456789AB	
40	: 0123456789AB	
50	: 0123456789AB	
60	: 0123456789AB	
70	: 0123456789AB	
80	: 0123456789AB	
90	: 0123456789AB	

5 PLU programming report

PGM			Range
		0001-0015	
PLU code	P0001(03)	0	Mode parameter
PLU text	MELON	1.25	Unit price
	P0002(01)	1	
	PLU0002	1.25	
	P0003(32)	1	
	PLU0003	-0.15	Associated dept. code
	PLU0014	0.00	
	P0015(01)	1	
	PLU0015	0.00	

TRAINING MODE

The training mode is used when the operator or the manager practices register operations.

When a clerk in training is selected, the machine automatically enters the training mode. To specify a clerk to be trained, refer to "Training clerk specification for training mode" in "ADVANCED PROGRAMMING" in [page 53](#).

The training operation is valid only in REG, MGR and VOID mode.

The corresponding clerk memory is only updated in the training mode.

Key operation example

A clerk set in training → 25 CLK#
 1000 5 21
 3 @FOR
3 19
CAVATNS

Print

08/26/2005	4:46PM	25
123456#1047	CLERK25	
TRAINING		
DEPT. 05	T1	\$10.00
	3 @	\$24.00
DEPT. 03	T1	\$72.00
MOSE ST		\$82.00
TAX1		\$5.13
ITEMS	4Q	
CASH		\$87.13

READING (X) AND RESETTING (Z) OF SALES TOTALS

- Use the reading function (X) when you need to take a reading of sales information entered since the last reset. You can take this reading any number of times. It does not affect the register's memory.
- Use the resetting function (Z) when you need to clear the register's memory. Resetting prints all sales information and clears the entire memory except for the GT1 through GT3, Training GT, reset count, and consecutive number.

1 Summary of Reading (X) and Resetting (Z) Reports

X1 and Z1 reports: Daily sales reports

X2 and Z2 reports: Periodic (monthly) consolidation reports

When you take a X or Z report, turn the mode switch to the appropriate position referring to the column of "Mode switch position" shown on the table below, and use the following corresponding key sequence.

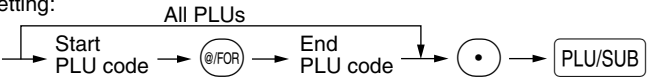
Item	Mode switch position			Key operation
	OPX/Z	X1/Z1	X2/Z2	
Flash report: (Only display) To clear the display, press the CL key or turn the mode switch to another position.	X	—	—	Dept. code → DEPT# : Department sales total <div style="border: 1px solid black; padding: 5px; width: fit-content; margin: 5px auto;"> For dept. 1 to 16; Dept. key (1¹⁷ to 16³²) For dept. 17 to 32; DEPTSHIFT → Dept. key (1¹⁷ to 16³²) </div>
				@/FOR key: Amount of cash in drawer
				CA/AT/NS key: Sales total
Full sales report	—	X1, Z1	X2, Z2	Reading: CA/AT/NS Resetting: • → CA/AT/NS
Individual clerk report	X, Z	—	—	Reading: CLK# Resetting: • → CLK# (The report of the current clerk)
Full clerk report	—	X1, Z1	—	Reading: CLK# Resetting: • → CLK#
PLU sales report	—	X1, Z1	—	Reading:  Resetting: 
Hourly report	—	X1, Z1	—	Reading: #/TM/SBTL Resetting: • → #/TM/SBTL

Note

- When both sales quantities and sales amounts are zero, printing is skipped. If you do not want to skip, change the programming. (Refer to "Print format" of "Various Function Selection Programming 1".)
- "X" represents read symbol and "Z" represents reset symbol in the reports.
- To stop reading and resetting the PLU sales report, turn the mode switch to the MGR position. The data will not be erased when you reset.
- When printing is performed continuously, the printing may be intermitted several seconds. After the intermission, the printing will be restarted.

2 Daily Sales Totals

Full sales report

Sample report

Z1		Mode title*1
	Z1 0001	Reset counter
		Net grand total(GT2-GT3)
GT1	\$00000002489.99	Grand total of plus registration
GT2	\$00000002644.05	Grand total of minus registration
GT3	-00000000154.06	Grand total of training mode registration
TR	\$00000000076.50	
DEPT		Dept. code
D01	70Q	Sales q'ty
FRUIT	\$317.17	Sales amount
D03	14Q	
DEPT. 03	\$221.00	
D05	11Q	
DEPT. 05	\$36.20	

DEPT. 50	\$150.00	
D99	1Q	
DEPT. 99	\$12.50	
*DEPT TL	276Q	} "+" dept. counter and total
	\$2273.67	
D02	7Q	
DEPT. 02	\$164.00	
DEPT (-)	7Q	} "-" dept. counter and total
	\$164.00	
* TRANS. *		
(-)	3Q	} Subtotal counter and total
	-3.00	
%1	4Q	} Subtotal percent 1 counter and total
	-4.72	
%2	1Q	
	\$1.88	
NET 1	\$2431.83	Next sales total
TAX1 ST	\$1536.20	Taxable 1 total
GRS TAX1	\$57.61	Gross tax 1 total
RFD TAX1	-1.86	Refund tax 1 total
TAX1	\$55.75	Net tax 1 total
TX1 EXPT	\$7.25	
TAX2 ST	\$35.15	
GRS TAX2	\$1.41	
TAX2	\$1.41	

M-TAX	\$1.00	Manual tax total
		--*3
TTL TAX	\$58.16	Tax total
NET	\$2431.83	Net total without tax
NET2	\$2489.99	Net total with tax
(-)	4Q	} Item counter and total
	-6.50	
%1	6Q	} Item percent 1 counter and total
	-1.80	
%2	5Q	
	\$2.62	
VOID	9Q	} REG-mode void counter and total
	\$48.78	
SBTL VD	4Q	} Subtotal void counter and total
	\$157.05	
MGR VD	2Q	} Manager item void counter and total
	\$12.22	
VOID	1Q	} Void-mode transaction counter and total
	\$12.22	
REFUND	17Q	} Refund counter and total
	\$73.60	
***RA	1Q	} Received on account counter and total
	\$48.00	
***PO	1Q	} Paid out counter and total
	\$15.00	
NO SALE	5Q	No-sales counter
TRANS CT	88Q	Customer counter
NET3	\$2489.99	Sales total
CASH	79Q	} Cash counter and total
	\$2223.59	
CHECK	2Q	} Check sales counter and total
	\$20.15	
CHARGE	7Q	} Charge sales counter and total
	\$259.53	
CHARGE-	1Q	} Charge refund counter and total
	-10.63	
CONV 1	500.00	Foreign currency total (preset)
CONV 2	200.00	Foreign currency total (open)
***CID	\$1719.77	Cash in drawer
CA+CH ID	\$1739.92	Cash + check in drawer
CHK/CG	\$2.65	Change total for check tendering

*1: When you take X1 report, "X1" is printed.

*2: Printed in the Z1 report only.

*3: When the Canadian tax system is selected, the following is printed here.

GST EXPT	\$292.11	Exempt total from GST
PST TTL	\$26.60	PST total
GST TTL	\$8.86	GST total

■ Clerk reports

Individual clerk report

• Sample report

OPX		Mode title*
* CLERK *		Report title
O1#	CLERK01	Clerk code
TRANS CT	87Q	Clerk name
NET3	\$2402.86	Customer counter
****CID	\$1632.64	
CA+CH ID	\$1652.79	
CHK/CG	\$2.65	

Full clerk report

The printout occurs in the same format as in the sample report of individual clerk, but all clerk's sales data are printed in the order of clerk code number (from #1 to #25).

■ Hourly report

• Sample report

X1		Mode title*
* HOURLY *		Report title
10:00AM	12Q	Customer counter
	\$116.89	Sales total
11:00AM	18Q	
	\$183.75	
12:00PM	25Q	
	\$199.91	
<hr/>		
5:00PM	18Q	
	\$134.63	
6:00PM	16Q	
	\$92.27	

*: When you take Z1 report, "Z1" is printed.

■ PLU sales report

• Sample report

X1		Mode title*
* PLU *	0001-0015	Report title
	35Q	Range
PLU code	P0001	Sales q'ty and total
Item label	PLU0001	
	\$52.50	
	P0002	
	24Q	
	\$35.00	
	P0010	
	9Q	
	\$64.35	
	P0011	
	10Q	
	\$120.00	
	P0012	
	1Q	
	\$0.00	
	P0013	
	-21Q	
	-44.10	
	P0015	
	1Q	
	\$22.12	
	***TOTAL	
	59Q	Range sum
	\$249.87	

*: When you take Z1 report, "Z1" is printed.

3 Periodic Consolidation

■ Full sales report

• Sample report

Z2		Mode title*1
	Z1 0001	Reset counter of daily total
	Z2 0001	Reset counter of periodic *2
GT1	\$00000003457.54	Grand total
GT2	\$00000003621.60	
GT3	-00000000164.06	
TR	\$00000000076.50	

The subsequent printouts are the same in format as in the X1/Z1 full sales report.

*1: When you take X2 report, "X2" is printed.

*2: Printed in the Z2 report only



EJ REPORT READING AND RESETTING

The cash register provides an electronic journal (EJ) function. This function is intended to record the journal data in a memory instead of journal paper, and print the data as an EJ report. The register records the journal data in REG, PGM, VOID, X1/Z1 and X2/Z2 modes. By default, a maximum of 2000 lines are stored in the memory, but you can expand it to 3000 lines. For details of EJ programming, please refer to "Electronic Journal Programming" section (page 45).

■ Printing journal data on the way of a transaction

You can print journal data of a current transaction recorded in EJ memory by pressing the **RCPT/PO** key during the transaction.

Note This function is valid when the printing style is programmed to receipt, and the receipt ON/OFF function is set to OFF.

• Sample print

*EJ *	_____	EJ report title
08/26/2005	2:56PM 01	
123456#1151	CLERK01	
DEPT. 03	T1 \$10.00	
DEPT. 04	T1 \$45.00	
EJ END	_____	EJ report end title

■ Reading and resetting the electronic journal data (Issuing EJ report)

You can read the journal data stored in the EJ memory in the journal format by executing the following procedure in the X1/Z1 or OP X/Z mode.

To read all of the data:

7 00 → @/FOR → CA/AT/NS

To reset all of the data:

7 00 → • → @/FOR → CA/AT/NS

To read the last 10 records:

7 1 0 → @/FOR → CA/AT/NS

Note

- On the EJ memory, a maximum of 2000 (or 3000, if programmed) lines of data can be stored. When executing all data reading, all of the data stored in the EJ memory will be printed. To save paper, compression print is available.
- To stop reading or resetting the data, turn the mode switch to "MGR" position. The data will not be erased when resetting.
- When printing is performed continuously, the printing may be intermitted several seconds. After the intermission, the printing will be restarted.

• Sample EJ report

OPX		
*EJ *		
08/26/2005	3:08PM 01	
123456#1162	CLERK01	
***PO	\$15.00	
08/26/2005	3:08PM 01	
123456#1163	CLERK01	
DEPT. 12	\$12.50	
ITEMS	10	
CHARGE	\$12.50	
08/26/2005	3:09PM 01	
123456#1164	CLERK01	
X1		
DEPT		
* TRANS. *		
08/26/2005	3:09PM 01	
123456#1165	CLERK01	

} Header information print

MDSE ST	\$50.00
TAX1	\$3.13
ITEMS	40
CASH	\$53.13
08/26/2005	3:10PM 01
123456#1166	CLERK01
DEPT. 03	T1 \$10.00
DEPT. 04	T1 \$45.00
MDSE ST	\$55.00
TAX1	\$3.44
ITEMS	20
CASH	\$58.44
08/26/2005	3:10PM 01
123456#1167	CLERK01
NO SALE	
EJ END	

OVERRIDE ENTRIES

Programmed limit for functions (such as for maximum amounts) can be overridden by making an entry in the MGR mode.

Procedure

1. Turn the mode switch to the MGR position.
2. Make an override entry.

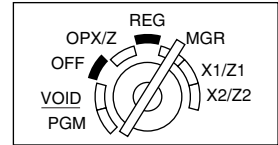

Example

On this example, the register has been programmed not to allow discounts entries over \$1.00.

Key operation example

REG-mode 1500 ¹⁹
 entries 250 ...Error

Turn the mode switch to the MGR position.

250

Return the mode switch to the REG position.

Print

DEPT. 03	T1	\$15.00
(-)		-2.50
MDSE ST		\$12.50
TAX1		\$0.94
ITEMS	1Q	
CASH		\$13.44

CORRECTION AFTER FINALIZING A TRANSACTION (Void mode)

When you need to void incorrect entries that clerks cannot correct (incorrect entries found after finalizing a transaction or cannot be corrected by direct or indirect void), follow this procedure:

1. Turn the mode switch to the VOID position using the manager key (MA), to enter into the void mode.
2. Repeat the entries that are recorded on an incorrect receipt. (All data for the incorrect receipt are removed from register memory; the voided amounts are added to the void-mode transaction totalizer.)

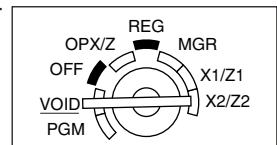

Incorrect receipt

DEPT. 04	T1	\$10.00
DEPT. 03	T1	\$1.50
MDSE ST		\$11.50
TAX1		\$0.72
ITEMS	2Q	
CASH		\$12.22



Cancellation receipt

VOID		
DEPT. 04	T1	\$10.00
DEPT. 03	T1	\$1.50
MDSE ST		\$11.50
TAX1		\$0.72
ITEMS	2Q	
CASH		\$12.22

OPERATOR MAINTENANCE

1 In case of Power Failure

When power is lost, the machine retains its memory contents and all information on sales entries.

- When power failure is encountered in register idle state or during an entry, the machine returns to normal operation after power recovery.
- When power failure is encountered during a printing cycle, the register prints “=====” and then carries out the correct printing procedure after power recovery. (See the sample print.)

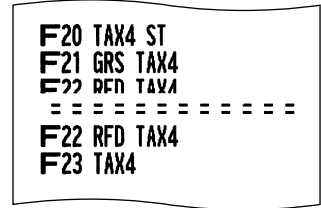

2 In Case of Printer Error

If the printer runs out of paper, the printer will stall, and “PPPPPPPPPP” will appear on the display. Key entries will not be accepted. Refer to section 5 in this chapter, install a new roll, then press the (CL) key. The printer will print the power failure symbol and resume printing.

If the print roller arm is not locked, the printer stalls, “H” will appear on the extreme left of the display. Key entries will not be accepted. Push down the arm until it is securely locked, then press the (CL) key. The printer will print the power failure symbol and resume printing.

3 Cautions in Handling the Printer and Recording Paper

■ Cautions in handling the printer

- Avoid dusty and humid environments, direct sunlight and iron powder. (A permanent magnet and electromagnet are used in this machine.)
- Never pull the paper when the print roller arm is locked. First lift up the arm, and then remove the paper.
- Never touch the surface of the print head and print roller.

■ Cautions in handling the recording paper (thermal paper)

- Use only the paper specified by SHARP.
- Do not unpack the thermal paper until you are ready to use it.
- Avoid heat. The paper will color at around 70°C.
- Avoid dusty and humid storage places. Avoid direct sunlight.
- The printed text on the paper can discolor under conditions of high humidity and temperature, exposure to the direct sunlight, contact with glue, thinner or a freshly copied blueprint, and heat caused by friction from scratching or other such means.
- Be very careful when handling the thermal paper. If you want to keep a permanent record, copy the printed text with a photocopier.

4 Replacing the Batteries

This cash register displays a low battery symbol (L) when the batteries are low, and displays a no battery symbol (L) when batteries are extremely low or batteries are not installed.

When the low battery symbol is displayed, replace the batteries with new ones as soon as possible. The existing batteries will be dead in about two days.

When the no battery symbol is displayed, replace the batteries immediately. Otherwise, if the AC power cord is disconnected or a power failure occurs, all the programmed settings will be reset to the default settings and any data stored in memory will be cleared.

Note Be sure to observe precautions shown on [page 1](#) when handling batteries.

To replace the batteries:

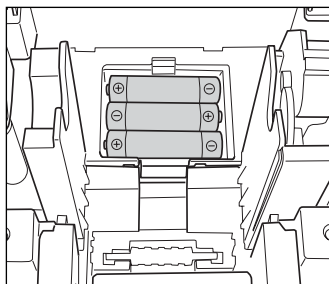

1. Make sure that the cash register is plugged in.
2. Turn the mode switch to the REG position.
3. Remove the printer cover.
4. Open the battery compartment cover next to the paper roll cradle and remove the old batteries.
5. Install three new "AA" batteries in the battery compartment. Be sure the positive and negative poles of each battery are facing in the proper direction. When they are installed correctly, the " L " or " L " symbol will disappear.
6. Close the battery compartment cover.
7. Replace the printer cover.

5 Replacing the Paper Roll

Be sure to use paper rolls specified by SHARP.

The use of any other paper rolls other than those specified could cause paper jamming, resulting in register malfunction.

Paper specification

Paper width: 2.25 ± 0.02 in (57.5 ± 0.5 mm)

Max. outside diameter: 3.15 in (80 mm)

Quality: Thermal paper

• Be sure to set the paper roll prior to using your machine, otherwise it may cause a malfunction.

Install the paper roll in the printer. Be careful to set the roll correctly.

(How to set the paper roll)

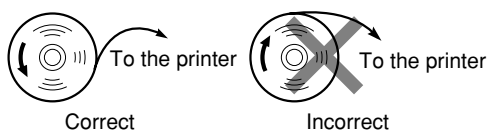

■ Removing the paper roll

When a red dye appears on the paper roll, it is time to replace it. Replace the paper roll with a new one. If you plan on not using the register for an extended period of time, remove the paper roll, and store it in an appropriate place.

Caution: The paper cutter is mounted on the printer cover. Be careful not to cut yourself.

When not using the take-up spool (using as receipt paper):

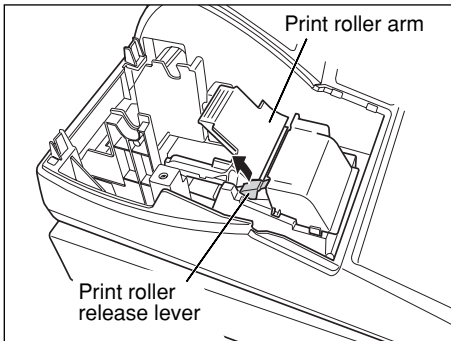

1. Remove the printer cover.
2. Lift up the print roller release lever to unlock and open the print roller arm.
3. Remove the paper roll from the paper roll cradle.

Note Do not pull the paper through the printer.

When using the take-up spool (using as journal paper):

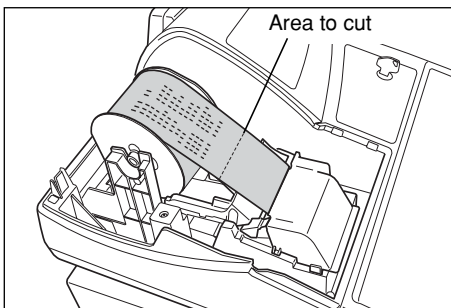

1. Turn the mode switch to a position other than OFF with the power cord connected.
2. Remove the printer cover.
3. Press the  key to advance the journal paper until its printed part is out of the way.
4. Cut the paper and remove the take-up spool.
5. Lift up the print roller release lever to unlock and open the print roller arm.
6. Remove the paper roll from the paper roll cradle.

Note Do not pull the paper through the printer.

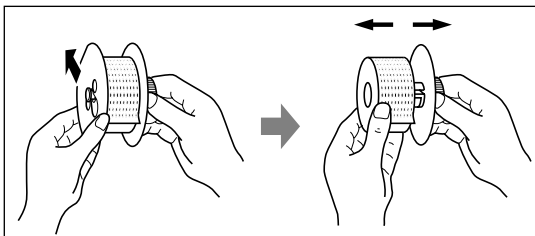

7. Remove the outer side of the take-up spool as shown on the left.
8. Remove the printed journal roll from the take-up spool.

■ Installing the paper roll

Caution: The paper cutter is mounted on the printer cover. Be careful not to cut yourself.

Installing the receipt paper roll:

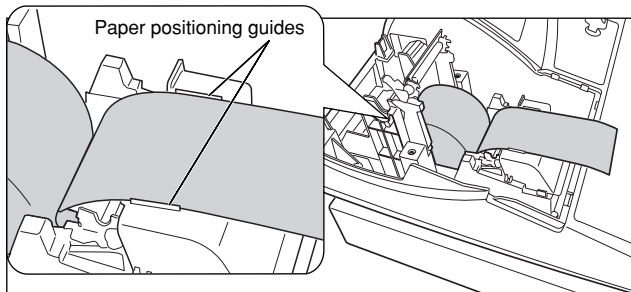

1. Turn the mode switch to a position other than OFF with the power cord connected.
2. Remove the printer cover.
3. Lift up the print roller release lever to unlock and open the print roller arm.
4. Set the paper correctly in the paper roll cradle.
5. Feed the end of the paper along with the paper positioning guides.

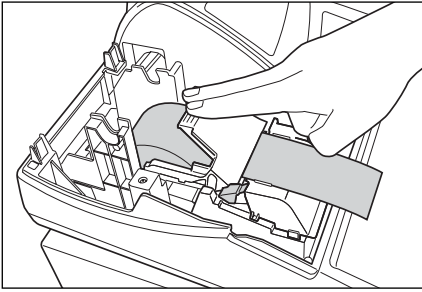

6. While holding down the paper, slowly close the print roller arm, and push down the arm until you hear a click locking the arm. Make sure securely you push down the center of the wing part of the arm as illustrated at the left. The paper will be fed automatically.

Note

If the print roller arm is not securely locked, printing is not done right. If this problem occurs, open the arm, and close the arm as instructed above.

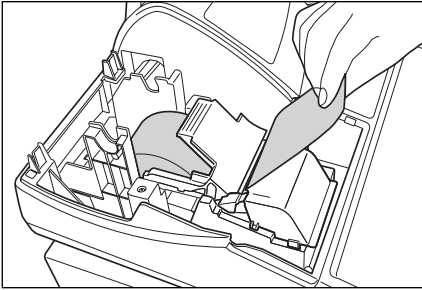



7. Cut off the excess paper using the edge of the inner cover, and replace the printer cover. Press the  key to make sure the paper end comes out of the printer cover and clean paper appears.

Note

If the paper end does not come out, open the printer cover, and pass the paper end between the paper cutter and the paper guide of the printer cover, and replace the cover.

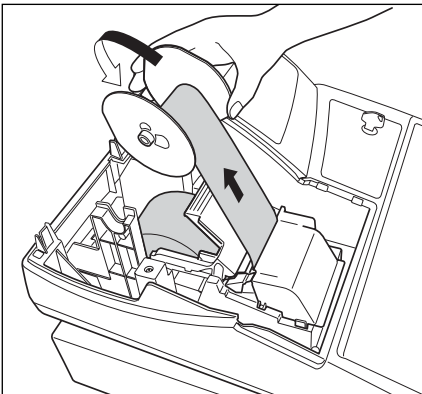
Installing the journal paper roll:



1. Turn the mode switch to a position other than OFF with the power cord connected.
2. Remove the printer cover.
3. Lift up the print roller release lever to unlock and open the print roller arm.
4. Set the paper correctly in the paper roll cradle.
5. Feed the end of the paper along with the paper positioning guides.
6. While holding down the paper, slowly close the print roller arm, and push down the arm until you hear a click locking the arm. Make sure securely you push down the center of the wing part of the arm as illustrated at the left. The paper will be fed automatically.
7. Insert the end of the paper into the slit in the spool. (Press the  key to feed more paper if required.)
8. Wind the paper two or three turns around the spool shaft.
9. Set the spool on the bearing, and press the  key to take up excess slack in the paper.
10. Replace the printer cover.

Note

You can wind the roll paper in OP X/Z, X1/Z1, and X2/Z2 modes even if you programmed so that the printer is used for issuance of receipts. This may be convenient to wind reports. In this case, set the roll paper to the take-up spool.

6 Removing a Paper Jam

Caution: The paper cutter is mounted on the printer cover. Be careful not to cut yourself. Never touch the print head immediately after printing, as the head may still be hot.

1. Remove the printer cover.
2. Lift up the print roller release lever to unlock the print roller arm, and open the print roller arm.
3. Remove the paper jam. Check for and remove any shreds of paper that may remain in the printer.
4. Reset the paper roll correctly by following the steps in "Installing the paper roll".

7 Cleaning the Printer (Print Head / Sensor / Roller)

When the printed text is getting dark or faint, paper dust may be stuck to the print head, sensor and/or roller. Clean them as follows:

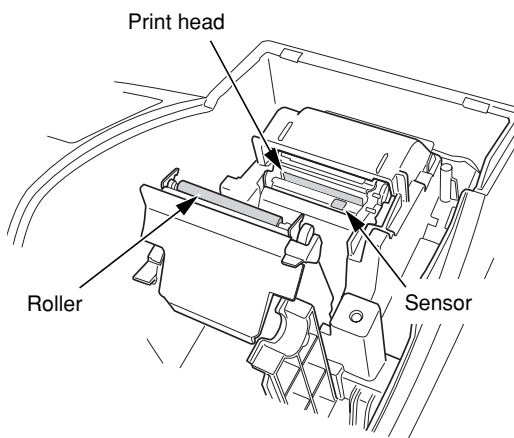

Caution:

- Never touch the print head with a tool or anything hard as it may damage the head.
- The paper cutter is mounted on the printer cover. Be careful not to cut yourself.

1. Turn the mode switch to the OFF position.
2. Remove the printer cover.
3. Lift up the print roller release lever to unlock and open the print roller arm.
4. Remove the paper roll referring to the "Removing the paper roll" section.
5. Clean the print head with a cotton swab or soft rag moistened with ethyl alcohol or isopropyl alcohol. Clean the roller and the sensor in the same manner.
6. Reset the paper roll correctly by following the steps in "Installing the paper roll".

8 Removing the Drawer

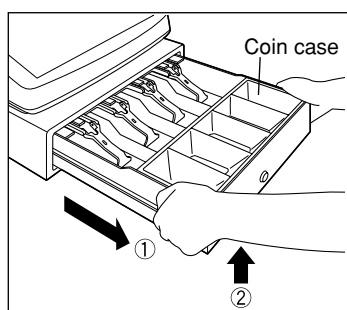

The drawer in the register is detachable. After closing your business for the day, remove the drawer. To detach the drawer, pull it forward fully, and remove it by lifting it up. The 5-denomination coin case is detachable.

9 Opening the Drawer by Hand

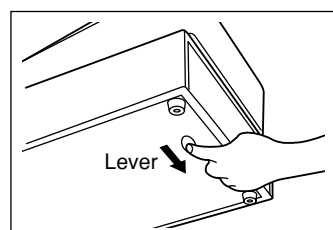

The drawer automatically opens. However, when a power failure occurs or the machine becomes out of order, slide the lever located on the bottom of the machine in the direction of the arrow. (See the figure at the left.) The drawer will not open if it is locked with the key.

10 Before Calling for Service

The malfunctions shown in the left-hand column below, labelled “Fault,” do not necessarily indicate functional faults of the machine. It is therefore advisable to refer to “Checking” shown in the right-hand column before calling for service.

Fault	Checking
(1) The display shows symbols that do not make sense.	<ul style="list-style-type: none"> • Has the machine been initialized properly as shown “GETTING STARTED”? (Note that initialization clears all the data and programmed settings stored in memory.)
(2) The display won't be illuminated even when the mode switch is turned to any other position than “OFF”.	<ul style="list-style-type: none"> • Is power supplied to the electrical outlet? • Is the power cord plug out or loosely connected to the electrical outlet?
(3) The display is illuminated, but the whole machine refuses registrations.	<ul style="list-style-type: none"> • Is a clerk code assigned to the register? • Is the mode switch set properly at the “REG” position?
(4) No receipt is issued.	<ul style="list-style-type: none"> • Is the paper roll properly installed? • Is there a paper jam? • Is the receipt function in the “OFF” status? • Is the print roller arm securely locked?
(5) No journal paper is taken up.	<ul style="list-style-type: none"> • Is the take-up spool installed on the bearing properly? • Is there a paper jam? • Is the journal printing selected in the printing style programming? (If the receipt printing is selected, the paper is not wound around the take-up spool.)
(6) Printing is unusual.	<ul style="list-style-type: none"> • Is the print roller arm securely locked? • Is the paper roll properly installed? • Are the print head/sensor/roller clean?

■ Error code table

When the following error codes are displayed, press the **CL** key and take a proper action according to the table below.

Error code	Error status	Action
E01	Registration error	Make a correct key entry.
E02	Misoperation error	Make a correct key entry.
E03	Undefined code is entered.	Enter a correct code
E07	Memory is full (in the AUTO key programming).	Program the AUTO key within 25 steps.
E11	Compulsory depression of the #/TM/SBTL key for direct finalization	Press the #/TM/SBTL key and continue the operation.
E12	Compulsory tendering	Make a tendering operation.
E32	No entry of a clerk code	Make a clerk code entry.
E34	Overflow limitation error	Make a registration within a limit of entry.
E35	The open price entry is inhibited.	Make a preset price entry.
E36	The preset price entry is inhibited.	Make an open price entry.
E37	The direct finalization is inhibited.	Make a tendering operation.
E67	Subtotal void is not allowed.	Finalize the transaction, and correct the wrong entries in the void mode.

SPECIFICATIONS

Model:	XE-A20S	
Dimensions:	13.0 (W) x 16.9 (D) x 11.0 (H) in. (330 (W) x 428 (D) x 280 (H) mm)	
Weight:	16.3 lb (7.4 kg)	
Power source:	120V AC \pm 10%, 60 Hz	
Power consumption:	Stand-by 7.7 W Operating 30 W (max.)	
Working temperature:	32 °F to 104 °F (0 °C to 40 °C)	
Electronics:	LSI (CPU) etc.	
Display:		
Operator display:	7-segment display (10 positions)	
Customer display:	7-segment display (7 positions)	
Printer:		
Type:	One-station thermal printer	
Printing speed:	Approx. 12 lines/second	
Printing capacity:	24 digits each for receipt and journal paper	
Other functions:	<ul style="list-style-type: none"> • Graphic logo printing function • Logo message function • Receipt (ON-OFF) function, compression printing function 	
Paper roll:	Width: 2.25 \pm 0.02 in (57.5 \pm 0.5 mm) Max. diam.: 3.15 in (80 mm) Quality: High quality (0.06 to 0.08 mm thickness)	
Cash drawer:	4 slots for bill and 5 for coin denominations	
Accessories:		
	Manager key	2
	Operator key	2
	Drawer lock key	2
	Paper roll	1
	Take-up spool	1
	USB cable (QCNWG3391RCZZ) *1	1
	Customer support tool	1 disk
	Quick Start Guide	1 copy
	Instruction manual	1 copy

Specifications and appearance subject to change without notice for improvement.

*1 Use only the USB cable (manufactured by SHARP) supplied with the XE-A20S for the connection with a PC.
 In case you need a new USB cable, order the USB cable manufactured by SHARP Co. Ltd. (Part code: QCNWG3391RCZZ) for use with the XE-A20S.

Use these labels with the department keys. Write department names on the labels and attach them to the department keys by first removing the transparent key covers. (Please make a copy of this page.)

Example:

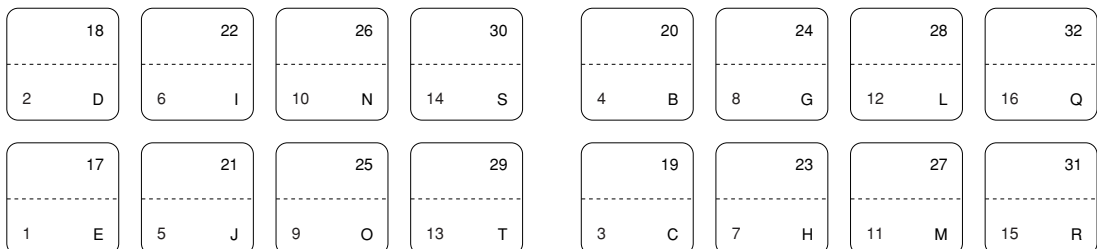

INTRODUCCION

Le agradecemos la adquisición de la caja registradora electrónica SHARP modelo XE-A20S. Sírvase leer este manual detenidamente antes de hacer funcionar la caja registradora para familiarizarse y comprender por completo sus funciones y características. Guarde este manual para futura referencia dado que le servirá de ayuda en caso de tener algún problema de funcionamiento con la caja registradora.

¡PRECAUCION!

- **No instale nunca las pilas en la caja registradora antes de haberla inicializado.** Antes de poner en funcionamiento la caja registradora, ésta deberá ser inicializada, y luego deben instalarse las pilas. De lo contrario, se perturbará el contenido de la memoria y se producirá el mal funcionamiento de la caja registradora. Para ver los procedimientos, consulte la [página 4](#).
- **Emplee sólo el cable USB (fabricado por SHARP) suministrado con el XE-A20S para la conexión a un ordenador personal. No emplee nunca otros cables.**

IMPORTANTE

- **La impresora tiene instalado un cortador para cortar el papel del rollo. Tenga mucho cuidado de no cortarse con el cortador.**
- **Instale la caja registradora en un lugar en el que no esté expuesta a radiaciones directas, cambios anormales de temperatura, alta humedad o en contacto con agua.**
Si la instala en estos lugares, podría originar daños en la caja y en los componentes electrónicos.
- **No opere nunca la caja registradora con las manos mojadas.**
El agua podría filtrarse al interior de la registradora y causar averías en sus componentes.
- **Cuando limpie la caja registradora, utilice un paño suave y seco. No use nunca líquidos volátiles como por ejemplo bencina y/o disolventes.**
La utilización de estos productos químicos hará que la caja pierda color o sufra daños.
- **La registradora debe enchufarse a cualquier tomacorriente normal de pared (120V CA ±10%).**
Otros aparatos eléctricos enchufados en el mismo circuito eléctrico pueden hacer que la registradora funcione mal.
- **Para protegerse contra la pérdida de datos, instale tres pilas del tamaño “AA” después de haber inicializado la caja registradora. Cuando manipule las pilas, no se olvide nunca de observar lo siguiente:**
Las pilas usadas incorrectamente pueden reventar o provocar pérdidas y dañar posiblemente el interior de la caja registradora.
 - **Asegúrese de que los polos positivo (+) y negativo (-) de cada pila estén colocados en el sentido correcto para la instalación.**
 - **No mezcle nunca pilas de diferentes tipos.**
 - **No mezcle nunca pilas nuevas y usadas.**
 - **No deje nunca pilas agotadas en el compartimiento de las pilas.**
 - **Saque las pilas, si no piensa usar la caja registradora durante mucho tiempo.**
 - **Si una pila perdiera, limpie inmediatamente el compartimiento de las pilas, teniendo cuidado de que el líquido que sale de la pila no entre en contacto directo con la piel.**
 - **Para deshacerse de las pilas, siga las leyes vigentes en su país.**
- **Si la caja registradora no funciona como debiera, solicite el servicio llamando al 1-800-BE-SHARP. No intente reparar la caja registradora usted mismo.**
- **Para desconectar por completo la alimentación eléctrica, desenchufe la clavija del tomacorriente.**

Línea directa de asistencia a los clientes 1-800-BE-SHARP

Para realizar la configuración con facilidad, vea el apartado “PARA EMPEZAR” ([página 4](#)).

INDICE

INTRODUCCION.....	1
IMPORTANTE.....	1
INDICE	2
PARTES Y SUS FUNCIONES	3
PARA EMPEZAR.....	4
REGISTRO BASICO DE VENTAS	5
1 Ejemplo de registro básico de ventas	5
2 Aviso de error	6
3 Registros de artículos	6
Registros de un solo artículo	6
Registros repetidos	7
Registros de multiplicación	7
Registros de precios divididos	7
Registros de venta en metálico de un solo artículo (SICS)	8
4 Visualización de los subtotales	8
5 Finalización de una transacción	8
6 Cálculo de los impuestos	9
CARACTERISTICAS OPCIONALES	9
1 Registros auxiliares	9
2 Tratos de pagos auxiliares	10
3 Registros con tecla de secuencia automática (tecla )	11
CORRECCION.....	11
PROGRAMACION DE LAS FUNCIONES BASICAS (Para el inicio rápido).....	12
1 Programación de la fecha y de la hora	12
2 Programación de los impuestos para la función de cálculo automático de los impuestos	12
PROGRAMACION DE FUNCIONES AUXILIARES	14
1 Programación de secciones	14
2 Programación de PLU (codificación de precios) y subsección	15
3 Programación de teclas misceláneas.....	16
4 Programación de texto	18
PROGRAMACION AVANZADA.....	22
1 Programación de número de caja registradora y de números consecutivos	22
2 Programación del registro diario electrónico (EJ)	22
3 Programación 1 de selección de diversas funciones	23
4 Programación 2 de selección de diversas funciones	26
5 Lectura de programas almacenados	28
MODO DE INSTRUCCION	28
LECTURA (X) Y REPOSICION (Z) DE LOS TOTALES DE VENTAS	29
LECTURA Y REPOSICION DE INFORMES EJ.....	30
REGISTROS DE ANULACION.....	31
CORRECCION DESPUES DE FINALIZAR UNA TRANSACCION (Modo de cancelación).....	31
MANTENIMIENTO PARA EL OPERADOR.....	31
1 En caso de corte de la alimentación	31
2 En el caso de error de impresora	31
3 Precauciones al manejar la impresora	31
4 Reemplazo de las pilas	32
5 Reemplazo del rollo de papel.....	32
6 Extracción del papel atascado	33
7 Limpieza de la impresora (cabezal de impresión / sensor / rodillo)	34
8 Extracción del cajón	34
9 Abertura manual del cajón	34
10 Antes de solicitar el servicio de un técnico.....	35

PARTES Y SUS FUNCIONES

1 Selector de modo y llaves de modo

El selector de modo funciona insertando una de las dos llaves de modo suministradas: la llave del administrador (MA) y la del operador (OP). Estas llaves pueden insertarse o sacarse sólo cuando el selector esté en la posición "REG" u "OFF".

El selector de modo tiene estos ajustes:

OFF: Este modo bloquea todas las operaciones de la caja. (La alimentación de CA está desconectada.) No hay cambios en los datos registrados.

OP X/Z: Para sacar informes X o Z de dependiente individual, y para sacar informes rápidos. Puede usarse para alternar el estado "ON" u "OFF" de emisión de recibos pulsando la tecla **RCPT/PO**.

REG: Para registrar ventas.

PGM: Para programar diversos artículos.

VOID: Para establecer la caja registradora en el modo de cancelación. Este modo permite la corrección después de haber finalizado una transacción.

MGR: Para los registros del administrador. El administrador puede usar este modo para un registro de anulación.

X1/Z1: Para sacar el informe X/Z de varios totales diarios.

X2/Z2: Para sacar el informe X/Z de consolidación periódica (semanal o mensual).

2 Visualizadores

Importe: Aparece en las ocho posiciones (máx.) de la derecha. Cuando el importe es negativo, aparece el signo de menos "-" delante del importe.

Número de repeticiones para registros repetitivos:

Se visualiza el número de repeticiones, empezando por "2" y se incrementa con cada repetición. Cuando haya registrado diez veces, la visualización mostrará "0". (2 → 3 9 → 0 → 1 → 2 ...)

Estado de la función de recibo:

Aparece el indicador "-" en la posición RCPT OFF cuando se pone la función de recibo en el estado OFF.

Hora: Aparece en las seis posiciones de la derecha (hora-minutos-"H" u hora-minutos-"P") en el modo OP X/Z, REG, o MGR. En los modos REG o MGR, pulse la tecla **#/TM/SBTL** para visualizar la hora.

■ Símbolos del estado de la máquina

P : Aparece durante la programación.

E : Aparece cuando se detecta un error.

□ : Aparece cuando se visualiza el subtotal o cuando se entrega un importe menor que el importe de las ventas.

C : Aparece cuando se pulsa la tecla **CONV** para calcular un subtotal en moneda extranjera.

F : Aparece cuando se finaliza una transacción pulsando la tecla **CA/AT/NS**, **CHK** o **CH**.

L : Aparece cuando se visualiza el importe del cambio.

E-E : Puede aparecer en las tres posiciones de la izquierda al efectuar una entrada de teclas cuando la memoria del registro diario electrónico (EJ) está llena. (Dependiendo de la programación.)

L : Aparece cuando la tensión de las pilas instaladas está por debajo del nivel necesario.

L : Aparece cuando las pilas no están instaladas, o cuando las pilas instaladas están gastadas.

• : Es posible que aparezca justo debajo de las posiciones octava y novena al realizar la finalización de una transacción cuando la memoria del registro diario electrónico (EJ) está casi llena. También aparece justo debajo de la décima posición cuando está activada el modo de ahorro de energía.

H : Aparece cuando el brazo del rodillo impresor no está bloqueado.

PPPPPPPPPP : Aparece cuando no está colocado el papel o cuando se ha terminado.

PARA EMPEZAR

Siga el procedimiento mostrado a continuación. Las pilas no están instaladas y la alimentación está desconectada.

1. Inicialice la caja registradora

Para que la caja registradora pueda funcionar correctamente, deberá inicializarla antes de ponerla en funcionamiento por primera vez. Siga el procedimiento siguiente.

1. Inserte la llave de administrador (MA) en el selector de modo y gírelo a la posición REG.
2. Enchufe la clavija a la toma de corriente de CA. El zumbador sonará tres veces.
IMPORTANTE: Esta operación debe efectuarse antes de haber instalado las pilas.
3. La caja registradora habrá quedado ahora inicializada.
El visualizador de la caja registradora mostrará "0.00" con " L ".

2. Instale las pilas

Las tres pilas nuevas del tamaño "AA" se deben colocar en la caja registradora para evitar que los datos y ajustes de programación se borren de la memoria, cuando se desconecte accidentalmente el cable de alimentación de CA, o en caso de un corte de corriente.

Instale las tres pilas nuevas del tamaño "AA" de acuerdo con el siguiente procedimiento con el cable de CA enchufado y con el selector de modo puesto en la posición REG. Asegúrese de observar las precauciones indicadas en la [página 1](#) sobre la manipulación de las pilas.

1. Empuje la cubierta de la impresora hacia delante y sepárela.
Tenga mucho cuidado con el cortador de papel, porque podría cortarse.
2. Abra la cubierta del compartimiento de las pilas que se encuentra al lado del soporte del rollo de papel.
3. Inserte tres pilas nuevas del tamaño "AA".
Cuando las pilas están correctamente instaladas, desaparecerá " L " del visualizador.
4. Cierre la cubierta del compartimiento de las pilas.

3. Instale un rollo de papel



1. Levante la palanca de liberación del rodillo impresor para desbloquear y abrir el brazo del rodillo impresor.
2. Ponga un rollo de papel en el soporte del rollo de papel.
3. Haga avanzar el extremo del papel junto con las guías de papel.
4. Mientras mantiene retenido el papel, cierre lentamente el brazo del rodillo impresor, y empuje el brazo hacia abajo hasta oír un sonido seco de confirmación. Asegúrese que empuja con seguridad el centro de la parte del ala del brazo. El papel avanzará automáticamente.

Nota *Si el brazo del rodillo impresor no está bloqueado correctamente, no se podrá imprimir con éxito. Si ocurre este problema, abra el brazo, y ciérrelo de nuevo como se ha indicado arriba.*

5. Cuando no emplee el carrete de toma (empleo como papel de recibos):

- Corte el papel sobrante empleando el borde de la cubierta interior, y vuelva a colocar la cubierta de la impresora. Pulse la tecla  para asegurarse que el papel sale por la cubierta de la impresora y que aparece papel limpio.

Cuando emplee el carrete de toma (empleo como papel de registro diario):

- Inserte el extremo del papel en la ranura del carrete. (Pulse la tecla  para hacer avanzar más el papel si es necesario.)
- Bobine el papel dos o tres vueltas en torno al eje del carrete.
- Coloque el carrete en el rodamiento, y pulse la tecla  para tensar el papel.
- Vuelva a colocar la cubierta de la impresora.

4. Programe la fecha, la hora y los impuestos

Nota *La caja registradora le ofrece los idiomas inglés, francés y español para el texto. El idioma preajustado es el inglés. Si desea cambiar el idioma, deberá cambiarlo antes de realizar la programación. Consulte el apartado de "Selección del idioma" de la sección "Programación 2 de selección de diversas funciones" para cambiar el idioma.*

Antes de poder seguir con el registro de las ventas, **deberá programar:**

- la fecha
- la hora
- los impuestos

Consulte la sección de PROGRAMACION DE LAS FUNCIONES BASICAS para encontrar más detalles ([página 12](#)).

5. Programe otros elementos necesarios

Aunque la caja registradora viene ya programada para poderla utilizar con la mínima configuración, la máquina le ofrece las funciones opcionales. Antes de comenzar la programación, lea la sección de operaciones de ventas para entender las funciones opcionales.

REGISTRO BASICO DE VENTAS

1 Ejemplo de registro básico de ventas

A continuación se muestra un ejemplo de registro básico de ventas de artículos de sección en metálico. Para los detalles de la operación, consulte cada sección respectiva.

Ajuste del selector de modo

1. Gire el selector de modo a la posición REG.

Asignación de dependientes

2. Introduzca su código de dependiente. (Por ejemplo, si el código de dependiente es el 1. Pulse las teclas **1** y **CLK#** en este mismo orden.)

Registros de artículos

3. Introduzca el precio para el primer artículo de sección. (Por ejemplo, para 15,00, introduzca **1** **5** **00**, y pulse la tecla de la sección correspondiente.)

Para las secciones 17 a la 32, pulse primero la tecla **DEPTSHIFT** antes de pulsar la tecla de la sección.

Para la sección 33 y posteriores, introduzca el código de sección empleando las teclas numéricas, y pulse la tecla **DEPT#**, y luego introduzca el precio y pulse de nuevo la tecla **DEPT#**.

4. Repita el paso 3 para todos los artículos de sección.

Visualización de subtotales

5. Pulse la tecla **#/TM/SBTL** para visualizar el importe a cobrar.

Finalización de la transacción

6. Introduzca el importe recibido del cliente. (Podrá omitir este paso si el importe recibido es el mismo que el subtotal.)

7. Pulse la tecla **CA/AT/NS** y se visualizará la vuelta (cuando no se ha introducido el importe recibido, se visualizará el importe total) y se abrirá el cajón.

8. Corte el recibo y dáselo al cliente con su vuelta.

9. Cierre el cajón.

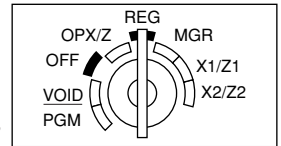

Ejemplo de operación de teclas

Asignación de dependiente	→ 1 CLK#	-01-
Registros de artículos	1500 1 17	01 15.00
	2300 2 18	02 23.00
Visualización del subtotal	→ #/TM/SBTL	0 40.38
	5000	5000
Finalización de la transacción	→ CA/AT/NS	€ 9.62

(En este ejemplo, la tasa de impuestos está ajustada a 6,25%.)

Impresión

YOUR RECEIPT THANK YOU		Membrete gráfico
08/26/2005 2:33PM 01		Fecha/hora/número de código de dependiente
123456#0012 CLERK01		Número de caja registradora/número consecutivo/nombre de dependiente
DEPT. 01 T1 \$15.00		Artículos
DEPT. 02 T1 \$23.00		Precio
MDSE ST \$38.00		Subtotal de mercancías
TAX1 \$2.38		Importe de impuestos
		No se imprime cuando sólo se venden artículos no imponibles.
ITEMS 20		Estado de impuestos (T1: imponible 1)
***TOTAL \$40.38		Cantidad total
CASH \$50.00		Importe total
CHANGE \$9.62		Pago en metálico/importe recibido
		Vuelta

Función ON/OFF (de emisión/no emisión) de recibos

Cuando emplea la impresora para emitir recibos, podrá inhabilitar la impresión de recibos en el modo REG. Pulse la tecla **RCPT/PO** en la posición OP X/Z. Esta tecla cambia el estado de impresión de recibos de ON a OFF.

Para emitir un recibo cuando la función de recibo ON/OFF está desactivada (OFF):

Si el cliente quiere el recibo después de haber finalizado la transacción con la función de recibo ON/OFF desactivada (OFF), pulse la tecla **RCPT/PO**.

Modo de ahorro de energía

La caja registradora se establecerá en el modo de ahorro de energía cuando no se efectúe ningún registro basándose en el límite de tiempo ya programado (ajuste inicial de 30 minutos). Cuando la caja registradora se establezca en el modo de ahorro de energía, se apagará toda la visualización excepto el punto decimal de la posición de la izquierda. La caja registradora volverá al modo de operación normal al pulsar alguna tecla o al cambiar un modo.

2 Aviso de error

En los siguientes ejemplos, la caja registradora se coloca en estado de error haciendo sonar un aviso audible y visualizando el símbolo de error “E” en el visualizador. Anule el estado de error pulsando la tecla **CL** y tome las medidas oportunas.

Consulte la tabla de códigos de error en la [página 35](#).

- Registra un número de más de 32 dígitos (desborde del límite de registro): Cancele el registro y vuelva a introducir un número correcto.
- Se equivoca en la operación de teclas: Borre el error y continúe la operación.
- Hace un registro más allá del límite de registro de importes programado: Vea si el importe registrado es correcto. Si es correcto, puede introducirse en el modo MGR. Llame al administrador.
- Un subtotal con impuestos incluido excede de ocho dígitos: Borre el subtotal pulsando la tecla **CL** y pulse la tecla **CAVAT/INS**, **CHK** o **CH** para finalizar la transacción.

Función de escape de error

Cuando desee abandonar una transacción debido a un error o a un imprevisto, emplee la función de escape de error como se muestra a continuación:

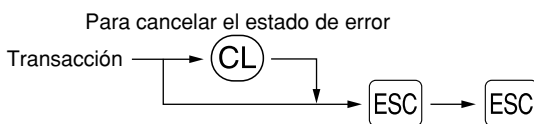

La transacción se cancela (se trata como un subtotal cancelado) y se emite el recibo mediante esta función. Si ya había introducido el importe entregado para el pago, la operación se finaliza como una venta en metálico.

3 Registros de artículos

Registros de un solo artículo

Registros de sección

- **Cuando se emplean las teclas de sección (para las secciones 1 a 32)**

Cuando utilice un precio unitario programado

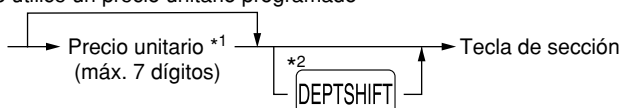

*1 Menos que los importes de límite superior programado
Cuando se introduce cero, sólo se añade la cantidad de ventas.

*2 Para las secciones opcionales 17 a 32, pulse la tecla **DEPTSHIFT**.

• **Cuando se emplea la tecla de registro de código de sección**

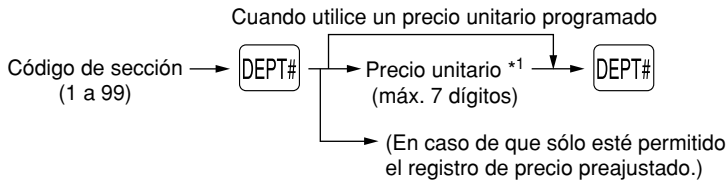

*1 Menos que los importes de límite superior programado
 Cuando se introduce cero, sólo se añade la cantidad de ventas.

Registros de PLU/subsecciones

La caja registradora ya está programada para el modo PLU y cero para el precio unitario. Para emplear entradas de PLU, deberán haberse programado de antemano sus precios unitarios preajustados. (Consulte la [página 15.](#)) Para emplear los registros de subsecciones, cambie al modo de subsección para los códigos de PLU.

• **Registros de PLU**

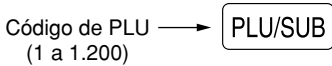

• **Registros de subsección (PLU abierta)**

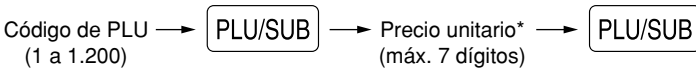

* Menos que los importes de límite superior programado
 Cuando se introduce cero, sólo se añade la cantidad de ventas.

■ **Registros repetidos**

Puede utilizar esta función para registrar una venta de dos o más artículos iguales. Repita la pulsación de una tecla de sección, tecla **DEPT#** o tecla **PLU/SUB**.

■ **Registros de multiplicación**

Cuando venda una gran cantidad de artículos, es conveniente emplear el método de registro de multiplicación. Introduzca la cantidad empleando las teclas numéricas y pulse la tecla **@/FOR** antes de comenzar el registro de artículos.

■ **Registros de precios divididos**

Esta función es práctica cuando un cliente desea comprar artículos que normalmente se venden en lotes. Para llevar a cabo esta función, deberá cambiar el ajuste programado. Consulte el apartado “Programación 1 de selección de diversas funciones” (código de tarea 70) para ver los detalles de la programación.

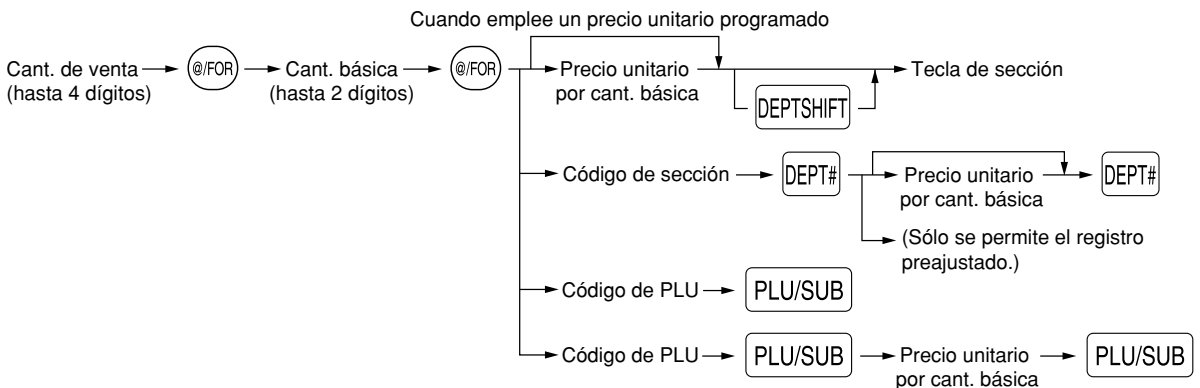

■ Registros de venta en metálico de un solo artículo (SICS)

- Esta función es útil cuando se vende solamente un artículo en metálico. Esta función es aplicable sólo a las secciones que se han ajustado para SICS o a sus PLU o subsecciones asociadas.
- Se completa la transacción y el cajón se abre tan pronto como pulse la tecla de sección, la tecla **DEPT#** o la tecla **PLU/SUB**.

4 Visualización de los subtotales

La caja registradora ofrece tres tipos de subtotales:

Subtotal de mercancías

Pulse la tecla **MDESBTL** en cualquier momento durante la transacción. Aparecerá el subtotal de venta neto, sin incluir los impuestos, en el visualizador.

Subtotal imponible

Subtotal de imponible 1

Pulse las teclas **TAX1SHIFT** y **#/TM/SBTL** en este orden en cualquier momento durante la transacción. Aparecerá el subtotal de venta de los artículos de imponible 1 en el visualizador.

Subtotal de imponible 2

Pulse las teclas **TAX2SHIFT** y **#/TM/SBTL** en este orden en cualquier momento durante la transacción. Aparecerá el subtotal de venta de los artículos de imponible 2 en el visualizador.

Subtotal incluyendo los impuestos (subtotal completo)

Pulse la tecla **#/TM/SBTL** en cualquier momento durante la transacción. Aparecerán el subtotal de venta con los impuestos incluidos y el símbolo “□” en el visualizador.

5 Finalización de una transacción

■ Importe recibido en metálico o cheque

Pulse la tecla **#/TM/SBTL** para obtener un subtotal con impuestos incluidos, registre el importe entregado por el cliente, y entonces pulse la tecla **CA/AT/NS** si el importe es en metálico o pulse la tecla **CHK** si el importe es un cheque. Cuando el importe recibido es mayor que el importe de la venta, la registradora le mostrará el importe del cambio y se encenderá el símbolo “⌈”. De lo contrario, la registradora mostrará un déficit y se encenderá el símbolo “□”. Ahora deberá hacer el registro correcto del importe recibido.

■ Ventas en metálico o cheque que no necesitan un registro

Registre los artículos y pulse la tecla **CA/AT/NS** si se trata de una venta en metálico o pulse la tecla **CHK** si es una venta con cheque. La caja registradora visualizará el importe total de la venta.

■ Venta a cargo en cuenta (crédito)

Registre los artículos y pulse la tecla de cargo (**CH**).

■ Ventas con importe recibido mixto

Podrá efectuar la mezcla de pagos con cheques y metálico, metálico y a cargo en cuenta, y cheque y a cargo en cuenta.

Por ejemplo: Su cliente paga \$9,50 en metálico y \$40,00 a cargo a su cuenta para un subtotal de \$49,50 con impuestos incluidos.

Ejemplo de operación de teclas

~ **#/TM/SBTL** 950 **CA/AT/NS** **CH**

6 Cálculo de los impuestos

■ Impuestos automáticos

Cuando se ha programado una tasa de impuestos (o tabla de impuestos) en la caja registradora y el estado de impuestos para una sección individual está ajustado a imponible, la caja calcula los impuestos automáticos para cualquier artículo que se introduzca directamente en la sección o indirectamente mediante una PLU relacionada.

■ Impuestos manuales

La máquina le permite introducir manualmente los impuestos después de haber terminado el registro de artículos.

Ejemplo: Venta en metálico de un artículo de \$8,00 (sección 12) con 50 centavos como impuestos

Ejemplo de operación de teclas

800 12 50

■ Borrado de los impuestos

Podrá borrar los impuestos automáticos en el subtotal de imponible 1 y de imponible 2 de cada transacción pulsando la tecla después de haberse visualizado el subtotal.

Para efectuar el borrado del subtotal de imponible 1, pulse , para obtener el subtotal de imponible 1, y entonces pulse para borrar el subtotal.

Para efectuar el borrado del subtotal de imponible 2, pulse , para obtener el subtotal de imponible 2, y entonces pulse para borrar el subtotal.

Para borrar todo el subtotal de imponible (1-4), pulse , , y en este orden.

■ Cambio del estado de impuestos

La máquina le permitirá cambiar el estado de impuestos programado de cada tecla de sección o de PLU pulsando las teclas y/o antes de tales teclas. Después de completar cada registro, el estado de impuestos programado de cada tecla se repondrá al programado.

CARACTERÍSTICAS OPCIONALES

1 Registros auxiliares

■ Registros de descuento y recargo empleando la tecla de porcentaje

La tecla de porcentaje se emplea para aplicar un porcentaje de descuento o recargo manualmente introducido o preajustado a artículos individuales o a un subtotal de mercancías. Para el registro manual del porcentaje de descuento o de recargo, introduzca el porcentaje (hasta 100,00) con las teclas numéricas (necesitará un punto decimal cuando introduzca una tasa porcentual fraccionaria), y pulse la tecla de porcentaje. Cuando emplee un porcentaje preajustado (si se ha programado), pulse tan sólo una tecla de porcentaje.

Cálculo porcentual para el subtotal de mercancías

Ejemplo de operación de teclas

~ **MDSESRTL** 10 **%1** **CA/AT/NS**

Cálculo porcentual para registros de artículos

Ejemplo de operación de teclas

800 **6**²² 7 **•** 5 **%1** **CA/AT/NS**

■ Registros de descuento y recargo empleando la tecla de descuento

La tecla de descuento se emplea para aplicar un importe de descuento o recargo manualmente introducido o preajustado a artículos individuales o a un subtotal de mercancías. Para el registro manual de los importes de descuento o de recargo, introduzca el importe con las teclas numéricas, y pulse la tecla de descuento. Cuando emplee un importe preajustado (si se ha programado), pulse una tecla de descuento.

Descuento para el subtotal de mercancías

Ejemplo de operación de teclas

~ **MDSESRTL** 100 **⊖** **CA/AT/NS**

Descuento para registros de artículos

Ejemplo de operación de teclas

675 **7**²³ **⊖** **CA/AT/NS**

■ Registros de devolución

Para las secciones 1 a 16, introduzca el importe de devolución y pulse la tecla **RFND**, y luego pulse la tecla de la sección correspondiente, y para las secciones 17 a 32, introduzca el importe de devolución y pulse la tecla **RFND**, y luego pulse la tecla **DEPTSHIFT** y pulse la tecla de la sección correspondiente (cuando emplee el precio preajustado, omita la introducción del importe). En el caso de las secciones 33 a 99, introduzca el código de sección y pulse la tecla **RFND** y la tecla **DEPT#**, y luego introduzca el importe de devolución y pulse la tecla **DEPT#** cuando sea necesario.

Para la devolución de un artículo de PLU, introduzca el código de PLU y pulse la tecla **RFND**, y luego pulse la tecla **PLU/SUB**.

Para la devolución de un artículo de subsección, introduzca el código de PLU y pulse la tecla **RFND** y la tecla **PLU/SUB**, y luego introduzca el importe de devolución y pulse la tecla **PLU/SUB**.

■ Registros e impresión de números de código de no suma

Podrá introducir un número de código de no suma, como pueda ser un número de código de cliente o número de tarjeta de crédito, con un máximo de 16 dígitos, en cualquier momento durante el registro de una venta. La caja registradora lo imprimirá.

Para introducir un número de código de no suma, introduzca el número y pulse la tecla **#TM/SBTL**.

2 Tratos de pagos auxiliares

■ Conversión de divisas

La caja registradora permite registros de pago con divisas (sólo está disponible el pago en metálico). Pulsando la tecla **CONV** se crea un subtotal en la divisa en cuestión.

Cuando emplee una tasa de cambio de divisas programada, pulse la tecla **CONV** después de los registros de los artículos, e introduzca entonces el importe recibido en la divisa si no se trata de un pago con el importe justo, y pulse la tecla **CA/AT/NS**.

Cuando efectúe un registro manual de la tasa de cambio de divisas, después de los registros de todos los artículos, introduzca la tasa de cambio (0,0000 a 9999,9999; necesitará un punto decimal cuando introduzca una tasa de cambio fraccionaria), y pulse la tecla **CONV**, y luego introduzca el importe en la divisa en cuestión si no es un pago del importe justo, y pulse la tecla **CA/AT/NS**.

En ambos casos, la vuelta se visualizará en moneda nacional y, cuando el importe recibido sea insuficiente, el déficit se mostrará en moneda nacional.

Nota

- Pulse la tecla **CL** después de pulsar la tecla **CONV** para cancelar el pago en una divisa.
- Si se programa, se imprime un símbolo de moneda extranjera cuando emplea una tasa preajustada.

■ Registros de recibido a cuenta y de pagado

Cuando recibe un pago a cuenta o cuando usted paga a un abastecedor, es aconsejable emplear la tecla **RA** o la tecla **RCP/PO** respectivamente. Los pagos en metálico sólo están disponibles en la operación RA y PO.

Para el registro de recibido a cuenta, introduzca el importe y pulse la tecla **RA**.

Para el registro de pagado, introduzca el importe y pulse la tecla **RCP/PO**.

■ Sin ventas (cambios)

Cuando deba abrir el cajón para algo que no sea una venta, pulse tan sólo la tecla **CA/AT/NS**. El cajón se abrirá y la registradora imprimirá "NO VENTA" en el registro diario o en el recibo.

3 Registros con tecla de secuencia automática (tecla **AUTO**)

Puede lograr una transacción programada pulsando simplemente la tecla **AUTO**.

CORRECCION

1 Corrección del último registro (cancelación directa)

Si hace un registro incorrecto relativo a una sección, PLU/subsección, porcentaje (**%1** y **%2**), descuento (**⊖**) o devolución, puede cancelar este registro pulsando la tecla **VOID** inmediatamente después del registro incorrecto.

2 Corrección del registro siguiente al último o anterior (cancelación indirecta)

Podrá cancelar cualquier registro de sección incorrecto, registro de PLU/subsección o registro de devolución de artículo hechos durante una transacción, si lo encuentra antes de finalizar la transacción (por ejemplo, pulsando la tecla **CA/AT/NS**). Esta función es aplicable sólo a los registros de sección, PLU/subsección y de devolución.

Para la operación, pulse la tecla **VOID** justo antes de pulsar una tecla de sección, la tecla **DEPT#**, o la tecla **PLU/SUB**.

Para la cancelación indirecta de devolución, pulse la tecla **VOID** después de haber pulsado la tecla **RFND**.

3 Cancelación del subtotal

Puede cancelar una transacción completa. Una vez ejecutada la cancelación del subtotal, la transacción se detiene y la registradora emite un recibo. Esta función no funciona cuando se han introducido más de 30 artículos.

Ejemplo de operación de teclas

1310 **2**¹⁸ 10 **PLU/SUB** **#/TM/SBTL** **VOID** **#/TM/SBTL**

Cancelación de subtotal

PROGRAMACION DE LAS FUNCIONES BASICAS (Para el inicio rápido)

Para programar la caja registradora, ponga la llave del administrador en el selector de modo y gírela a la posición PGM.

- Los asteriscos en las tablas mostradas en los detalles de programación indican los ajustes iniciales.

1 Programación de la fecha y de la hora

■ Fecha

Para ajustar la fecha, introduzca la fecha con 8 dígitos empleando el formato de mes-día-año (MM/DD/AAAA), y pulse entonces la tecla **#/TM/SBTL**.

Ejemplo de operación de teclas

08262005 **#/TM/SBTL**
(Agosto 26, 2005)

■ Hora

Para ajustar la hora, introduzca la hora con 4 dígitos empleando el formato de 24 horas. Por ejemplo, para ajustar la hora a las 2:30 AM, introduzca 230; y para ajustarla a las 2:30 PM, introduzca 1430.

Ejemplo de operación de teclas

1430 **#/TM/SBTL**

2 Programación de los impuestos para la función de cálculo automático de los impuestos

Antes de poder proceder al registro de ventas, primero deberá programar los impuestos que se cargan de acuerdo con las leyes de su estado. En esta caja registradora pueden programarse cuatro tasas de impuestos distintas. En la mayor parte de estados, sólo será necesario programar los impuestos 1. Sin embargo, si vive en una zona que tiene impuestos locales propios o impuestos de hospitalidad, podrá programar la caja registradora para que calcule estos impuestos por separado.

Cuando programe el estado de impuestos para una sección, los impuestos se añadirán automáticamente a los artículos de venta asignados a la sección de acuerdo con el estado de impuestos programado para la sección. También podrá introducir manualmente los impuestos.

Hay dos métodos para programar los impuestos. El método de la tasa de impuestos emplea una tasa porcentual directa por dólar. El método de tabla de impuestos requiere la información detallada de impuestos para las oficinas de impuestos estatales o locales. Emplee el método que sea aceptable para su estado. Podrá obtener los datos necesarios en la oficina de impuestos local para efectuar la programación de los impuestos.

■ Programación de los impuestos empleando una tasa de impuestos

La tasa porcentual aquí especificada se emplea para calcular los impuestos sobre subtotales imponibles.

Procedimiento

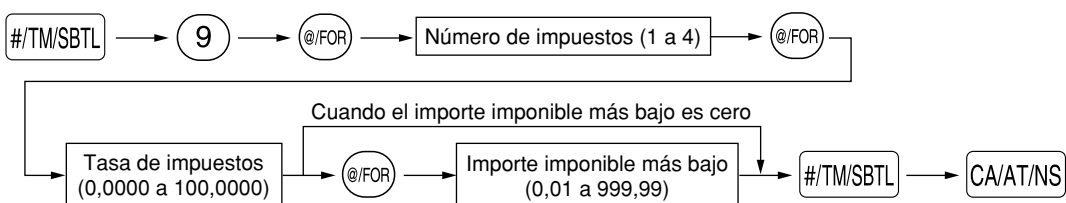

Ejemplo: Programación de la tasa de impuestos del 4% como tasa de impuestos 2 con exención de impuestos de 12¢

Ejemplo de operación de teclas

#/TM/SBTL 9 @/FOR 2 @/FOR 4 @/FOR 12 #/TM/SBTL CA/AT/NS

Tabla de impuestos (aplicable al impuesto añadido)

Si se encuentra en una localidad que emplea una tabla de impuestos para el cálculo de los impuestos, podrá programar consecuentemente la caja registradora. La programación de la tabla de impuestos puede efectuarse para impuestos 1 a impuestos 4.

Tabla de impuestos de muestra

Tabla de impuestos de New Jersey: 6%

Impuestos	Margen de importe de venta		
	Punto de división mínimo		Punto de división máximo
.00	.01	a	.10
.01 — T	.11 — Q	a	.22
.02	.23	a	.38
.03	.39	a	.56
.04	.57	a	.72
.05	.73	a	.88
.06	.89	a	1.10
.07	1.11 — M1	a	1.22
.08	1.23	a	1.38
.09	1.39	a	1.56
.10	1.57	a	1.72
.11	1.73	a	1.88
.12	1.89	a	2.10
.13	2.11 — M2	a	2.22



A: Diferencia entre el punto de división mínimo y el siguiente (¢)	
—	B: No cíclico
10 (0.11 - 0.01)	C: Cíclico 1
12 (0.23 - 0.11)	
16 (0.39 - 0.23)	
18 (0.57 - 0.39)	
16 (0.73 - 0.57)	
16 (0.89 - 0.73)	D: Cíclico 2
22 (1.11 - 0.89)	
12 (1.23 - 1.11)	
16 (1.39 - 1.23)	
18 (1.57 - 1.39)	
16 (1.73 - 1.57)	
16 (1.89 - 1.73)	
22 (2.11 - 1.89)	

Para programar una tabla de impuestos, primero haga una tabla como la tabla de la derecha arriba mostrada. Partiendo de la tabla de impuestos, calcule las diferencias entre el punto de división mínimo y el siguiente (A). Luego, partiendo de las diferencias, busque ciclos irregulares (B) y ciclos regulares (C y D). Estos ciclos le mostrarán los elementos necesarios para programar la tabla de impuestos:

- T:** El importe de impuestos recolectados en el importe imponible mínimo (Q)
- Q:** El importe imponible mínimo
- M1:** El valor máximo del punto de división mínimo en un ciclo regular (C)
A esto lo denominamos "punto MAX".
- M2:** El valor máximo del punto de división mínimo en un ciclo regular (D)
A esto lo denominamos "punto MAX".
- M:** Margen del punto de división mínimo en un ciclo regular: diferencia entre Q y M1 o entre M1 y M2.

Procedimiento

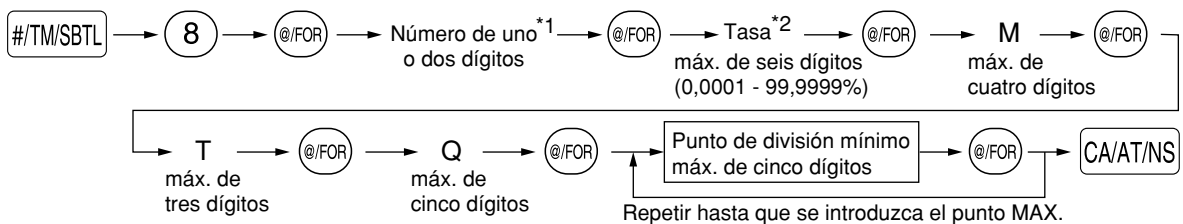

- *1 **Primer número:** (1 ó 0) Este primer número que se introduce depende de si la diferencia entre un punto de división mínimo a introducirse y el punto de división mínimo anterior no son de menos de \$1,00 ni de más de 99¢. Cuando la diferencia no sea de menos de \$1,00, introduzca "1", y cuando no sea de más de 99¢, introduzca "0" o no introduzca nada.
- Segundo número:** (1 a 4) El segundo número depende de si su tabla de impuestos debe programarse como tabla de impuestos 1, 2, 3, ó 4.
- *2 Si la tasa es fraccionaria (por ejemplo 4-3/8%), la fracción (3/8) se convierte a su equivalente decimal (es decir, 0,375) y se introduce la tasa resultante de 4,375. Tenga presente que la tasa nominal (R) generalmente se indica en la tabla de impuestos.

• **Limitaciones para el registro de puntos de división mínimos**

La caja registradora puede trabajar con una tabla de impuestos que conste hasta de 72 puntos de división como máximo. (El número máximo de puntos de división es de 36 cuando la diferencia de puntos de división es de \$1,00 o más.) Si el número de puntos de división excede la capacidad de tablas de la caja registradora, deberá emplear entonces el registro manual.

PROGRAMACION DE FUNCIONES AUXILIARES

1 Programación de secciones

La mercancía se puede clasificar en un máximo de 99 secciones.

■ Estado de sección

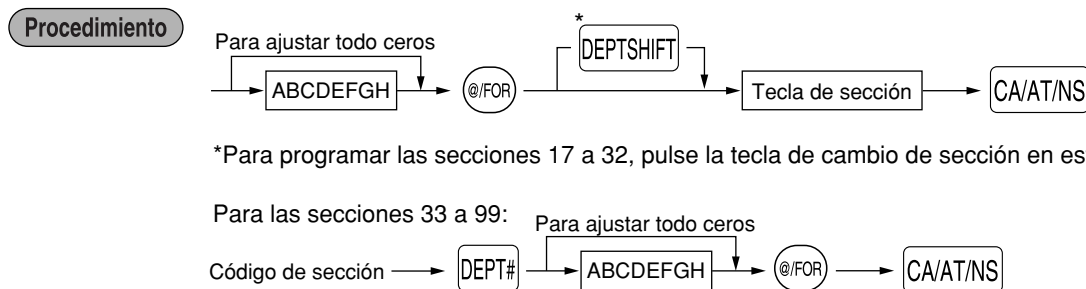

Para programar otra sección, comience desde el principio sin pulsar la tecla CA/AT/NS.

Elemento:	Selección:	Registro:
A Estado de impuestos 4	Imponible	1
	No imponible*	0
B Estado de impuestos 3	Imponible	1
	No imponible*	0
C Estado de impuestos 2	Imponible	1
	No imponible*	0
D Estado de impuestos 1	Imponible (*para las secciones 1 a 10)	1
	No imponible (*para las secciones 11 a 99)	0
E SICS / Normal	SICS	1
	Normal*	0
F Signo	Sección negativa	1
	Sección positiva*	0
G Límite de dígitos de entrada		0-7 (ajuste inicial: 7)
H Tipo de registros de precio unitario	Abertura y preajuste	3
	Sólo preajuste	2
	Sólo abertura*	1
	Tecla de sección invalidada	0

Estado de impuestos (imponible 1 a 4 / no imponible)

- Cuando se efectúa un registro de una sección imponible en una transacción, los impuestos se calculan automáticamente de acuerdo con la tabla o tasa de impuestos asociada.

SICS (Venta en metálico de un solo artículo)

- Si se efectúa primero un registro de una sección programada para SICS, la venta se finalizará como venta de pago en metálico así que se pulse la tecla de la sección.

Límite de dígitos de entrada

- El límite es eficaz para operaciones en el modo REG y puede pasarse por alto en el modo MGR.

■ Precio unitario preajustado

Procedimiento

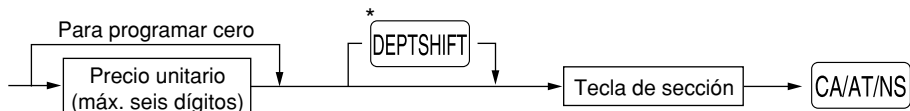

*Para programar las secciones 17 a 32, pulse la tecla de cambio de sección en este punto.

Para las secciones 33 a 99:

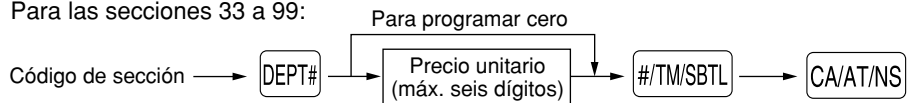

Para programar otra sección, comience desde el principio sin pulsar la tecla **CA/AT/NS**.

2 Programación de PLU (codificación de precios) y subsección

La función de PLU permite realizar registros rápidos con las teclas en los que el precio se busca automáticamente al introducir un código. La subsección es un tipo de "PLU abierta", que requiere que usted introduzca un precio detrás del código de PLU. Pueden realizarse un máximo de 1.200 ajustes de PLU/subsección. Cada una pertenece a una sección y adquiere los parámetros de la sección (estado de impuestos, SICS y signo).

La caja registradora ya está programada de modo que los 1.200 códigos están asignados a las PLU asociadas con la sección 1 y precio unitario preajustado "0".

■ Asignación de precios unitarios y de secciones asociadas

Procedimiento

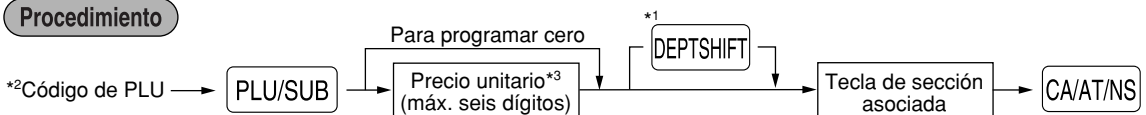

*1: Para asignar las secciones 17 a 32, pulse la tecla de cambio de sección en este punto.

Cuando la sección asociada es una de las secciones 33 a 99:

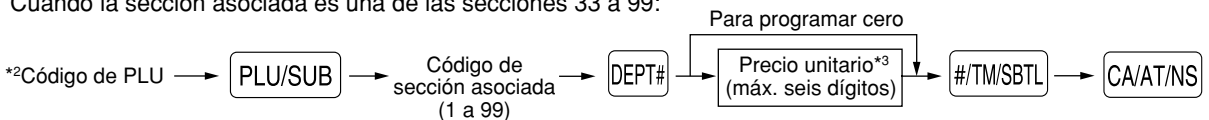

*2: 1 a 1.200 (Dependiendo del ajuste del tamaño de la memoria EJ, hasta 200)

*3: Para una subsección, ajuste el importe de límite del registro de precio unitario.

Para borrar un código de PLU, emplee la secuencia siguiente:

Procedimiento

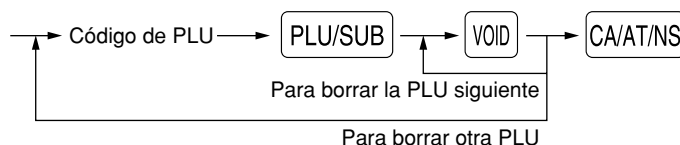

■ Selección de PLU/subsección

Procedimiento

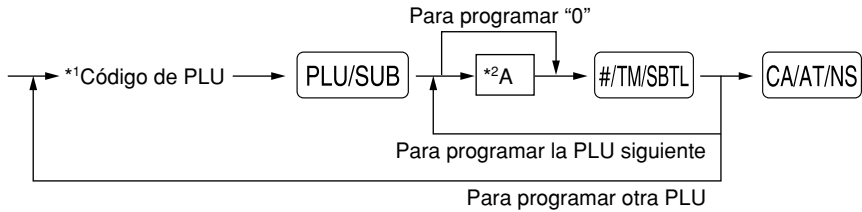

*1: 1 a 1.200 (Dependiendo del ajuste del tamaño de la memoria EJ, hasta 200)

*2: 0 para la subsección o 1 para PLU (ajuste inicial: 1)

3 Programación de teclas misceláneas

■ Tasa para %1, %2 y CONV

Procedimiento

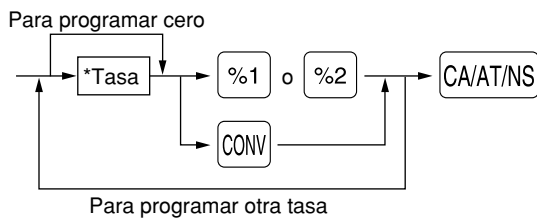

*: Tasa

0,00 – 100,00 (Tasa de porcentaje)

0,0000 – 9999,9999 (Tasa de conversión de divisas)

Deberá emplear un punto decimal para ajustar tasas fraccionarias.

■ Importe para ⊖

Procedimiento

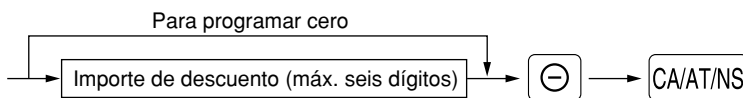

■ Límite de tasa porcentual para %1 y %2

Procedimiento

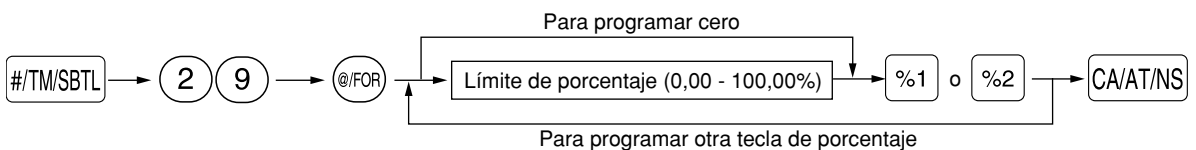

Nota

- Los registros porcentuales que exceden al límite superior pueden suprimirse en el modo MGR.
- 10,00% puede registrarse como (1)(0) o (1)(0)(•)(0)(0). La tecla (•) es necesaria sólo para los registros fraccionarios.

■ Parámetros de función para %1, %2 y ⊖

Procedimiento

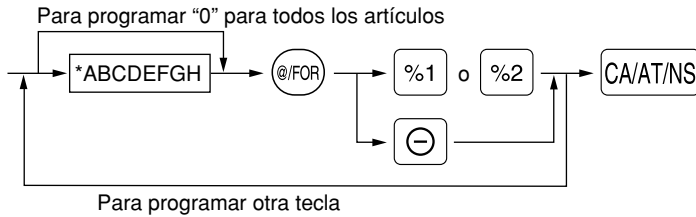

*: Elemento:	Selección:	Registro:
A Estado de impuestos 4	Imponible	1
	No imponible*	0
B Estado de impuestos 3	Imponible	1
	No imponible*	0
C Estado de impuestos 2	Imponible	1
	No imponible*	0
D Estado de impuestos 1	Imponible	1
	No imponible*	0
E Signo +/-	Signo + (recargo)	0
	Signo - (descuento)*	1
F % de artículo / ⊖ de artículo	Habilitar*	0
	Inhabilitar	1
G % de subtotal / ⊖ de subtotal	Habilitar*	0
	Inhabilitar	1
H Límite de dígitos de entrada para la tecla de descuento		0-7 (ajuste inicial: 7)

Cuando se programen las teclas de porcentaje, introduzca siempre 0 para H.

El límite de dígitos de entrada es eficaz para operaciones en el modo REG, pero puede suprimirse en el modo MGR.

■ Parámetros de función para CONV

Procedimiento

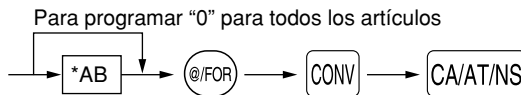

*: Elemento:	Selección:	Registro:
A Registro de tasa abierta	Habilitar*	0
	Inhabilitar	1
B Registro de tasa preajustada	Habilitar*	0
	Inhabilitar	1

■ Límite de dígitos de entrada para RA, RCPT/PO y TAX

Procedimiento

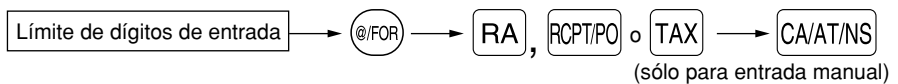

- Para RA, RCPT/PO, introduzca 0 a 9 (dígitos), y para TAX (impuestos manuales), introduzca 0 a 7 (dígitos). Como ajuste inicial, se ajustan 9 para RA y RCPT/PO y 7 para TAX.

El límite de dígitos de entrada es de hecho para operaciones en el modo REG, pero puede suprimirse en el modo MGR.

■ Parámetros de función para **CHK**, **CH** y **CA/AT/NS** (cuando se usa como tecla CA)

Procedimiento

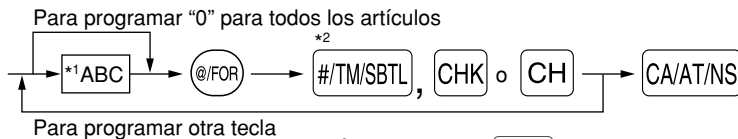

*2: Pulse la tecla **#/TM/SBTL** para ajustar la tecla CA.

*1:Elemento:	Selección:	Registro:
A Impresión de pie del recibo	Habilitar	1
	Inhabilitar*	0
B Registro de importe recibido	Obligatorio	1
	No obligatorio (para la tecla CA o CHK)*	0
	Invaldar (para la tecla CH)*	0
C Límite de dígitos de entrada		0-8

Impresión de pie del recibo

- Esta programación decide si la registradora debe imprimir un mensaje en la parte inferior del recibo cuando se usa una de estas teclas de finalización especificada. Con respecto al método de programación del mensaje del membrete del pie de recibo, consulte la sección "Mensajes de membrete" en la [página 21](#).

Límite de dígitos de entrada

- Para las teclas **CH** y **CHK**, programe un importe de entrada de límite superior para el importe recibido. Para la tecla **CA/AT/NS**, programe un importe de entrada de límite superior para el importe total en metálico que puede manipularse en la caja registradora.

4 Programación de texto

La caja registradora le permite programar el texto para los nombres de dependiente, nombres de artículos de sección, nombres de artículos de PLU/subsección, etc., cuando sea necesario. Hay dos formas de programar el texto: empleando las teclas de caracteres del teclado o introduciendo los códigos de los caracteres con las teclas numéricas del teclado.

Empleo de las teclas de caracteres del teclado

Podrá introducir caracteres de acuerdo con los caracteres pequeños que hay en la esquina inferior derecha de las teclas.

Las teclas siguientes se emplean como teclas de control para la entrada de caracteres:

- SHIFT** Cambia entre letras mayúsculas y minúsculas. El ajuste inicial es el de letras mayúsculas seleccionadas. Una vez se ha pulsado la tecla **SHIFT**, se fija la entrada para letras minúsculas. “_” se enciende en la posición SHIFT del visualizador cuando se selecciona la entrada de letras minúsculas.
- NUMBER** Pulse la tecla **NUMBER** para introducir caracteres numéricos. Por ejemplo para introducir “1”, pulse la tecla **NUMBER** y la tecla **1**. Si pulsa la tecla **1** sin pulsar la tecla **NUMBER**, la caja registradora se establece en el modo de entrada de códigos de caracteres. Una vez se ha pulsado la tecla **NUMBER**, se fija la entrada para caracteres numéricos. “_” se enciende en la posición NUMBER del visualizador cuando se selecciona la entrada de caracteres numéricos.
- DC** Cambia entre caracteres de tamaño normal y de tamaño doble. En el ajuste inicial se han seleccionado los caracteres de tamaño normal. Una vez se pulsa la tecla **DC**, se fija la entrada para caracteres de tamaño doble. “_” se enciende en la posición DC del visualizador cuando se selecciona la entrada de caracteres de tamaño doble.
- BS** Hace retroceder el cursor, borrando el carácter de la izquierda.

Ejemplo

Para programar la palabra "Clerk01" con la letra "C" de tamaño doble.

Para que la letra "C" sea de tamaño doble

DC C

Para que el tamaño de los caracteres vuelva al normal

DC

Para cambiar a letras minúsculas

SHIFT

L E R K

Para introducir números

NUMBER 0 1

Introducción de códigos de caracteres con las teclas numéricas del teclado

Los números, las letras y los símbolos pueden programarse introduciendo el código de carácter y la tecla (00). (Si se selecciona la entrada de caracteres numéricos, es decir, "_" se enciende en la posición NUMBER del visualizador, pulse la tecla NUMBER para que se apague.) Prepare la tabla de códigos de caracteres alfanuméricos de la página siguiente. De este modo, podrá programar caracteres distintos a los que hay en las teclas.

- Pueden obtenerse caracteres de tamaño doble introduciendo el código de caracteres 253.
- DEBEN introducirse los tres dígitos del código del carácter (aunque empiece con cero).

Ejemplo

Para programar la palabra "SHARP" en caracteres de tamaño doble.

253 (00) 083 (00) 072 (00) 065 (00) 082 (00) 080 (00)

S H A R P

Cuando pulsa una tecla del número apropiado (número de código de tarea) y pulsa la tecla (•) para entrada de texto justo después de haber comenzado la programación con la tecla #/TM/SBTL, la caja registradora quedará automáticamente preparada para la entrada siguiente.

Nota

Para los códigos de los caracteres alfanuméricos, consulte la tabla de la [página 40](#) de la versión inglesa.

■ Texto de sección

Procedimiento

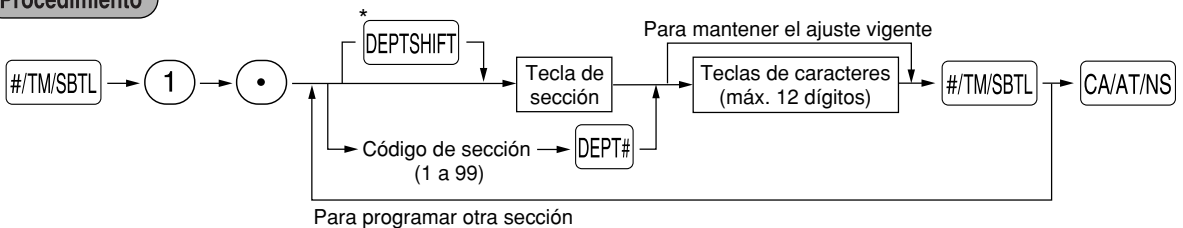

*Para programar las secciones 17 a 32, pulse la tecla de cambio de sección.

Ejemplo de operación de teclas

#/TM/SBTL 1 (•) (1¹⁷) FRUTA #/TM/SBTL CA/AT/NS

(Programación de FRUTA para la sección 1)

■ Texto de PLU (etiqueta de artículo)

Procedimiento

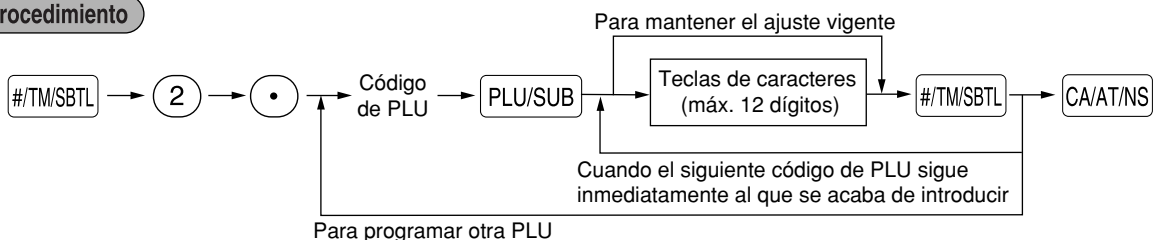

■ Texto de función

Procedimiento

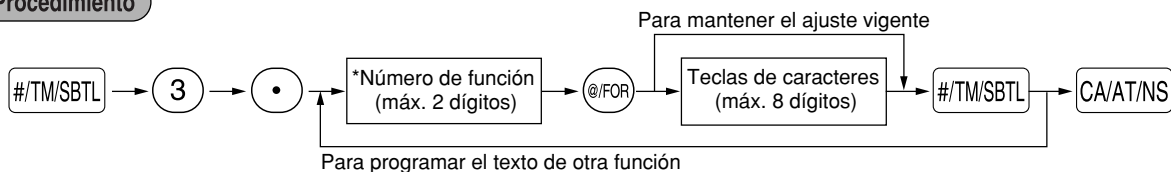

* Número de función: Vea la “Lista de textos de función” mostrada a continuación.

■ Lista de textos de función

Número de función	Tecla o función	Ajuste inicial	Número de función	Tecla o función	Ajuste inicial
1	⊖	(-)	36	Modo de cancelación	ANULA
2	%1	%1	37	Cancelación del administrador	ANUL MGR
3	%2	%2	38	Cancelación de subtotal	ANUL ST
4	Total neto de ventas	NETO 1	39	Sin venta	NO VENTA
5	Subtotal neto de imponible 1	TASABLE1	40	Recibido a cuenta	RECI. CTA
6	Total bruto de impuestos 1	TAX1 GRS	41	Pagos	PAGOS
7	Total de impuestos 1 de registros de devoluciones	TAX1 DEV	42	Contador de clientes	TRANSAC.
8	Total neto de impuestos 1	TAX1	43	Total de ventas	NETO 3
9	Exención de impuestos 1	TX1 EXNT	44	Metálico	CAJA
10	Subtotal neto de imponible 2	TASABLE2	45	Cheque	CHEQUE
11	Total bruto de impuestos 2	TAX2 GRS	46	Cargo bruto	CREDITO
12	Total de impuestos 2 de registros de devoluciones	TAX2 DEV	47	Cargo de devoluciones	CREDITO-
13	Total neto de impuestos 2	TAX2	48	Conversión de divisas 1 (preajustada)	DIVISA 1
14	Exención de impuestos 2	TX2 EXNT	49	Conversión de divisas 2 (abierta)	DIVISA 2
15	Subtotal neto de imponible 3	TASABLE3	50	Metálico en el cajón	EFEC. CAJ
16	Total bruto de impuestos 3	TAX3 GRS	51	Metálico+cheque en el cajón	CACH CAJ
17	Total de impuestos 3 de registros de devoluciones	TAX3 DEV	52	Cambio de cheques	CAMB. CH
18	Total neto de impuestos 3	TAX3	* 53	Exento de IVA	IVA EXNT
19	Exención de impuestos 3	TX3 EXNT	54	Total de secciones (+)	*DEPT TL
20	Subtotal neto de imponible 4	TASABLE4	55	Total de secciones (-)	DEPT(-)
21	Total bruto de impuestos 4	TAX4 GRS	56	Subtotal	SUBTOTAL
22	Total de impuestos 4 de registros de devoluciones	TAX4 DEV	57	Subtotal de mercancías	ST MERCA
23	Total neto de impuestos 4	TAX4	58	Total	*** TOTAL
24	Exención de impuestos 4	TX4 EXNT	59	Cambio	CAMBIO
25	Total bruto de impuestos manuales	MTAX GRS	60	Artículos	ARTICULO
26	Total de impuestos manuales de devoluciones	MTAX DEV	61	Título de informe de secciones	DEPT
27	Total neto de impuestos manuales	M-TAX	62	Título de informe de PLU	PLU
* 28	Total de exención desde GST	GST EXNT	63	Título de informe de transacciones	TRANS.
* 29	Total de PST	PST TTL	64	Título de informe de dependientes	EMPLEADO
* 30	Total de GST	GST TTL	65	Título de informe horario	HORARIO
31	Total de impuestos	TTL TAX	66	Símbolo de no adición	#
32	Neto	NETO	67	Título de copia de recibo	COPIA
33	Total de ventas incluyendo el total de impuestos	NETO 2	68	Título de informe EJ	EJ
34	Devoluciones	DEVOLUC.	69	Título de fin de informe EJ	FIN EJ
35	Cancelación de artículos	ANUL ART			

Los elementos marcados con “ * ” son sólo para Canadá.

■ Nombres de dependiente

Procedimiento

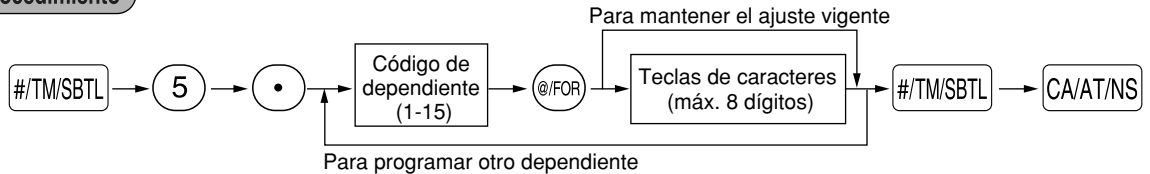

■ Mensajes de membrete

La caja registradora puede imprimir mensajes programados en cada recibo. En el modelo estándar, se imprime el membrete gráfico en el recibo. Si desea imprimir mensajes de membrete, cambie el formato de impresión de mensajes de membrete. (Para los detalles de la programación, vea la [página 27](#).) A continuación se enumeran las opciones:

Procedimiento

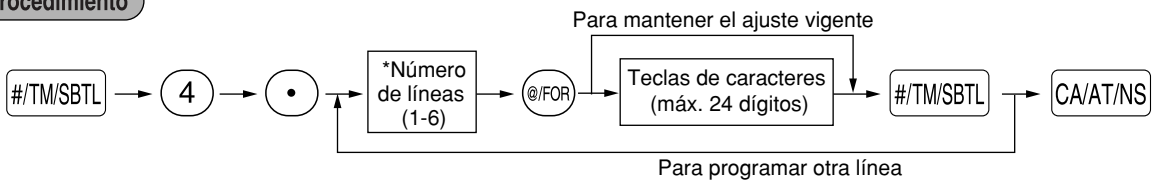

- * Tipo de "Mensaje de 3 líneas de encabezamiento": 1 a 3
- Tipo de "Mensaje de 3 líneas de pie de recibo": 4 a 6
- Tipo de "Mensaje de 6 líneas de encabezamiento": 1 a 6
- Tipo de "Mensaje de 3 líneas de encabezamiento y 3 líneas de pie de recibo": 1 a 6 (1 a 3 como encabezamiento, 4 a 6 como pie de recibo)

■ Símbolo de divisas

El símbolo de divisas para la tecla `CONV` se imprime con un importe de cambio de divisas.

Procedimiento

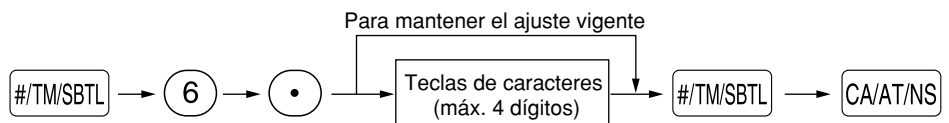

PROGRAMACION AVANZADA

1 Programación de número de caja registradora y de números consecutivos

El número de caja registradora y los números consecutivos se imprimen en el recibo o en el registro diario.

■ Número de caja registradora

Procedimiento

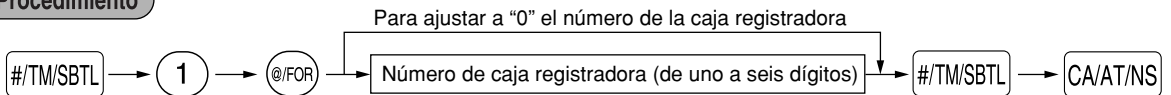

■ Números consecutivos

Procedimiento

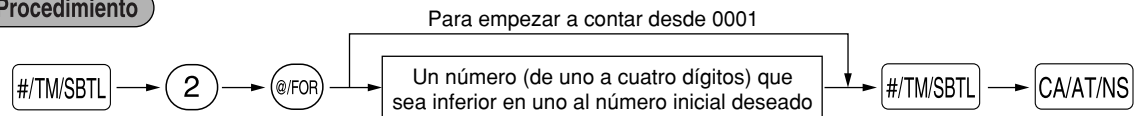

2 Programación del registro diario electrónico (EJ)

La caja registradora incorpora la función de registro diario electrónico (EJ). En el ajuste inicial, pueden almacenarse un máximo de 2.000 líneas en la memoria. Si desea almacenar más datos de registro diario, podrá ampliarla hasta un máximo de 3.000 líneas.

Para leer los datos del registro diario, consulte el apartado de “LECTURA Y REPOSICION DE INFORMES EJ” (página 30).

■ Tipo de memoria de EJ

Precaución Cuando se ejecuta este procedimiento, los datos de EJ se borran y los datos de PLU (datos de programación y datos de ventas) se reponen a los valores de ajuste inicial después de haber borrado todos los datos aunque se seleccione el mismo tipo de la memoria.

Procedimiento

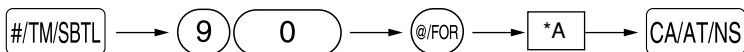

*A: 0 para 2.000 líneas de EJ y 1.200 códigos de PLU (ajuste inicial)

1 para 3.000 líneas de EJ y 200 códigos de PLU

■ Parámetros de función para el EJ

Procedimiento

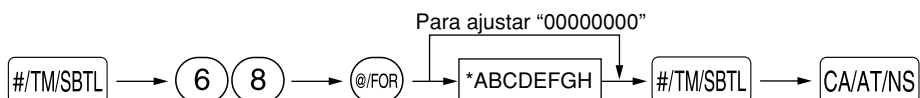

* Elemento:	Selección:	Registro:
A Introduzca siempre 0.	(Posición fija)	0
B Introduzca siempre 0.	(Posición fija)	0
C Impresión temporal de EJ durante una transacción	Inhabilitar Habilitar*	0 1
D Impresión de EJ y borrado de datos de EJ cuando se emite el informe Z1 general	No* Sí	0 1
E Tipo de registros de operación en el modo PGM	Detalles* Sólo información de encabezamiento	0 1
F Tipo de registros de operación en el modo REG/MGR/VOID	Detalles* Total	0 1
G Impresión comprimida para datos de EJ	No (tamaño normal) Sí (tamaño pequeño)*	0 1
H Acción cuando el área de memoria de EJ está llena	Continuar Avisar (aviso de casi llena)* Bloqueo (con aviso de casi llena)	0 1 2

En el ajuste inicial, se marca un asterisco.

Impresión temporal de EJ durante una transacción

- Si selecciona "Sí", podrá imprimir los datos del registro diario de la transacción actual registrada en la memoria de EJ pulsando la tecla **RCPTIPO** durante la transacción. Para poder realizar esta función por completo, la caja registradora está programada para la impresión del recibo y la función de activación/desactivación (ON/OFF) de recibo está desactivada (OFF).

Tipo de registros de operación en el modo PGM

- Se imprime sólo la información del encabezamiento durante la operación de lectura de datos de programación.
Para informes X/Z, se imprime sólo la información del encabezamiento.

Acción cuando el área de memoria de EJ está llena

- Según el ajuste inicial, cuando la memoria para EJ está casi llena, la caja registradora muestra puntos decimales en las posiciones octava y novena del visualizador (mensaje de memoria EJ casi llena), y la caja registradora sigue almacenando nuevos datos mientras va borrando los más antiguos. Cuando se seleccione "0", la caja registradora ya no mostrará el mensaje de memoria EJ casi llena. Cuando se seleccione "2", la caja registradora mostrará el mensaje de memoria EJ casi llena y cuando se llene totalmente la memoria, la caja registradora bloqueará la entrada de ventas/datos con una visualización del mensaje de memoria llena "E-E". Sólo podrá emitir un informe EJ.

3 Programación 1 de selección de diversas funciones

La caja registradora ofrece varias funciones detalladas como las que se mencionan a continuación.

- Selección de función para teclas misceláneas
- Formato de impresión
- Formato de impresión de recibos
- Selección de función para impuestos
- Otras

Para esta programación, se aplica el estilo de entrada de código de tarea. Podrá seguir la programación hasta que pulse la tecla **CA/AT/NS** para la programación que se describe a continuación. Para seguir la programación, repita desde la entrada de un código de tarea.

Procedimiento

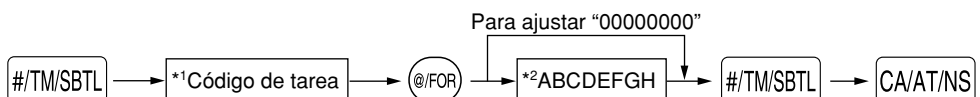

*1 Introduzca el código de tarea empleando las teclas numéricas especificadas en cada sección de abajo.

*2 Los detalles de la entrada de datos se enumeran en cada tabla de cada sección de abajo.

■ Selección de función para teclas misceláneas

Código de tarea: 5

* Elemento:	Selección:	Registro:	
A	PO en el modo REG	Habilitar la operación PO en el modo REG*	0
		Inhabilitarla	1
B	RA en el modo REG	Habilitar la operación RA en el modo REG*	0
		Inhabilitarla	1
C	Cancelación de subtotal en el modo REG	Habilitar la cancelación de subtotal en el modo REG*	0
		Inhabilitarla	1
D	Cancelación indirecta en el modo REG	Habilitar la cancelación indirecta en el modo REG*	0
		Inhabilitarla	1
E	Cancelación directa en el modo REG	Habilitar la cancelación directa en el modo REG*	0
		Inhabilitarla	1
F	Disponibilidad de la tecla de devoluciones	Habilitar registros de devolución en el modo REG*	0
		Inhabilitarlos	1
G	No venta en el modo REG	Habilitar las operaciones de no venta en el modo REG*	0
		Inhabilitarlas	1
H	Disponibilidad de cantidades fraccionarias	Habilitar el registro de cantidades fraccionarias	0
		Inhabilitarlo*	1

■ Formato de impresión

Código de tarea: 6

* Elemento:	Selección:	Registro:	
A	Estilo de impresión	Empleo de la impresora para impresión del registro diario	0
		Empleo de la impresora para impresión de recibos*	1
B	Formato de impresión de recibos	Total	0
		Detallado*	1
C	Impresión de la hora en todos los recibos/registro diario	Habilitar la impresión de la hora*	0
		Inhabilitarla	1
D	Impresión de la fecha en todos los recibos/registro diario	Habilitar la impresión de la fecha*	0
		Inhabilitarla	1
E	Impresión del N.º consecutivo en todos los recibos/registro diario	Habilitar la impresión del N.º consecutivo*	0
		Inhabilitarla	1
F	Introduzca siempre 0.	(Posición fija)	0
G	Salto de ceros para informe de PLU	Inhabilitar el salto de ceros	0
		Habilitar el salto de ceros*	1
H	Salto de ceros para informes generales, de dependientes y horarios	Inhabilitar el salto de ceros	0
		Habilitar el salto de ceros*	1

Estilo de impresión

- Incluso cuando se selecciona la impresión de recibos, el motor de rebobinado del registro diario será accionado en los modos PGM, OP X/Z, X1/Z1 y X2/Z2 para poder bobinar los informes de ventas y de programación.

■ Formato de impresión de recibos

Código de tarea: 7

* Elemento:	Selección:	Registro:	
A	Introduzca siempre 0.	(Posición fija)	0
B	Introduzca siempre 0.	(Posición fija)	0
C	Impresión de subtotal con una pulsación de la tecla de subtotal	Inhabilitar la impresión de subtotales*	0
		Habilitarla	1
D	Impresión de mercancías con una pulsación de la tecla de subtotal de mercancías	Inhabilitar la impresión de subtotal de mercancías*	0
		Habilitarla	1
E	Introduzca siempre 0.	(Posición fija)	0
F	Introduzca siempre 0.	(Posición fija)	0
G	Introduzca siempre 0.	(Posición fija)	0
H	Impresión del número de compras	Habilitar la impresión del número de compras*	0
		Inhabilitarla	1

■ Selección de función para impuestos

Código de tarea: 15

* Elemento:	Selección:	Registro:
A a F Introduzca siempre 0.	(Posición fija)	0
G Disponibilidad de borrado de los impuestos en el modo REG	Habilitar el borrado de impuestos en el modo REG* Inhabilitarlo	0 1
H Disponibilidad de entrada de impuestos manuales en el modo REG	Habilitar la entrada de impuestos manuales en el modo REG* Inhabilitarla	0 1

■ Otras programaciones

Código de tarea: 61

* Elemento:	Selección:	Registro:
A Introduzca siempre 0.	(Posición fija)	0
B Introduzca siempre 0.	(Posición fija)	0
C Disponibilidad de sección y PLU/subsección negativas	Inhabilitar la programación de sección y PLU/subsección negativas Habilitarla*	0 1
D Trato fraccionario	Redondeo (4 por defecto, 5 por exceso)* Aumento a la unidad Descartar el trato fraccionario	0 1 2
E Empleo de la tecla (00)	Empleo de la tecla (00) como tecla 00* Empleo de la tecla (00) como tecla 000	0 1
F Formato de la hora	Empleo del formato de 12 horas* Empleo del formato de 24 horas	0 1
G Formato de la fecha	Empleo del formato de mes-día-año* Empleo del formato de día-mes-año Empleo del formato de año-mes-día	0 1 2
H Posición del punto decimal (desde la derecha) (TAB)		0 a 3 (ajuste inicial: 2)

Código de tarea: 62

* Elemento:	Selección:	Registro:
A Introduzca siempre 0.	(Posición fija)	0
B Activación del pitido de error	Por error de bloqueo* Por operación incorrecta	0 1
C Disponibilidad del sonido de accionamiento de teclas	Habilitar el sonido* Inhabilitarlo	0 1
D Teclado con memoria intermedia	Sí* No	0 1
E Disponibilidad de la operación del modo de cancelación	Habilitar la operación del modo de cancelación* Inhabilitarla	0 1
F Impresión de datos de entradas en el modo de cancelación en los informes Z2	Habilitar la impresión de datos de entradas en el modo de cancelación en los informes Z2* Inhabilitarla	0 1
G Impresión de datos de entradas en el modo de cancelación en los informes Z1	Habilitar la impresión de datos de entradas en el modo de cancelación en los informes Z1* Inhabilitarla	0 1
H Adición de datos de total de ventas horario en el modo de cancelación	No* Sí	0 1

Código de tarea: 66

* Elemento:	Selección:	Registro:
A Impresión de un recibo después de la transacción	Sólo el total	0
	Detalles*	1
B Impresión del importe cuando el precio unitario de PLU/subsección es cero	Inhabilitar la impresión*	0
	Habilitarla	1
C Impresión del subtotal para conversión de déficit	Habilitar la impresión*	0
	Inhabilitarla	1
D Introduzca siempre 0.	(Posición fija)	0
E Impresión comprimida en el registro diario en los modos PGM, OP X/Z, X1/Z1 y X2/Z2	Inhabilitar la impresión comprimida (tamaño normal)	0
	Habilitar la impresión comprimida (tamaño pequeño)*	1
F Impresión comprimida en el registro diario en los modos REG, MGR y VOID	Inhabilitar la impresión comprimida (tamaño normal)	0
	Habilitar la impresión comprimida (tamaño pequeño)*	1
G Impresión del mensaje del membrete en el registro diario	Inhabilitar la impresión del mensaje del membrete en el registro diario*	0
	Habilitar la impresión del mensaje del membrete en el registro diario	1
H Impresión de pie de recibo	Impresión de pie de recibo en todos los recibos*	0
	Impresión de pie de recibo con la tecla de función seleccionada en el momento de la finalización	1

Impresión comprimida

- Esta programación sólo es válida cuando se selecciona la impresión del registro diario. No afecta la impresión de E.J. (Para la programación de E.J, consulte la [página 22.](#))

Código de tarea: 70

* Elemento:	Selección:	Registro:
A Cómputo de precios divididos	Cantidad*	0
	Paquete	1
B Disponibilidad de entrada de precios con multiplicación/división	Habilitar sólo la entrada de multiplicación*	0
	Habilitar la entrada de multiplicación y la de división de precios	1
C Introduzca siempre 0.	(Posición fija)	0
D Introduzca siempre 0.	(Posición fija)	0
E Impresión de impuestos cuando GST es IVA	Habilitar la impresión de impuestos*	0
	Inhabilitarla	1
F Impresión de exención de GST en informes X/Z	Habilitar la impresión de exención de GST*	0
	Inhabilitarla	1
G y H Sistema de cálculo de impuestos	Impuestos automáticos*	00
	Impuestos canadienses (número del tipo de impuestos)	01 a 11

Sistema de cálculo de impuestos

- Para el sistema de impuestos de EE.UU., seleccione “auto-tax” (impuestos automáticos).

4 Programación 2 de selección de diversas funciones

■ Modo de ahorro de energía

Procedimiento

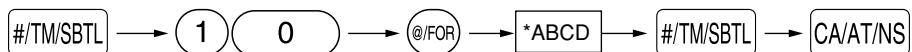

* Elemento:	Selección:	Registro:
A Entrar en el modo de ahorro de energía cuando se visualice la hora	Sí*	0
	No	1
B a D Tiempo (mín.) para entrar en el modo de ahorro de energía desde que se efectuó la última operación		001-254 ó 999 (Ajuste inicial: 030)

Nota Cuando se ajusta 999 para B a D, se inhabilita el establecimiento en el modo de ahorro de energía.

■ Formato de impresión del mensaje del membrete

Podrá seleccionar el número de líneas del mensaje del membrete, y la posición en la que se imprime en el recibo o registro diario.

Procedimiento

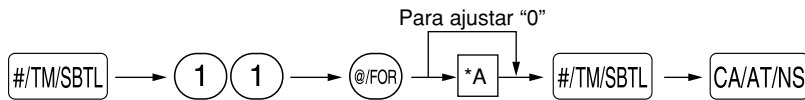

*A: Tipo de mensaje del membrete

- 0: Mensaje de 3 líneas de encabezamiento sin membrete gráfico
- 1: Sólo membrete gráfico (ajuste inicial)
- 2: Mensaje de 3 líneas de pie de recibo con membrete gráfico
- 3: Mensaje de 6 líneas de encabezamiento
- 4: Mensaje de 3 líneas de encabezamiento con membrete gráfico
- 5: Mensaje de 3 líneas de encabezamiento y mensaje de 3 líneas de pie de recibo

■ Ajuste de fin de intervalo en línea

Procedimiento

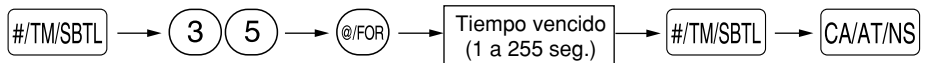

Ajuste inicial: 007

■ Densidad de impresora térmica

Procedimiento

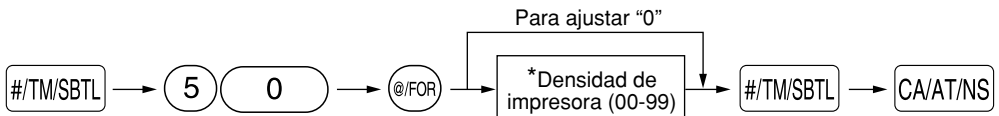

* El ajuste inicial es 50. Para oscurecer la impresión, ajuste un número mayor, y para que sea más clara, ajuste un número menor.

■ Selección del idioma

Procedimiento

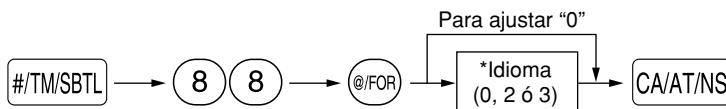

*Idioma: 0: Inglés 2: Francés 3: Español (ajuste inicial: Inglés)

Precaución

Cuando cambie el idioma, los textos como los del nombre de dependiente, mensaje de membrete y los textos de funciones, que usted haya programado, se repondrán a los ajustes iniciales. Por lo tanto, antes de programar nombres de dependiente, mensajes de membrete y textos de funciones, se debe hacer la selección del idioma.

■ Especificación de dependientes de instrucción para el modo de instrucción

Para los detalles sobre la instrucción de dependientes, consulte el "MODO DE INSTRUCCION" en la [página 28](#).

Procedimiento

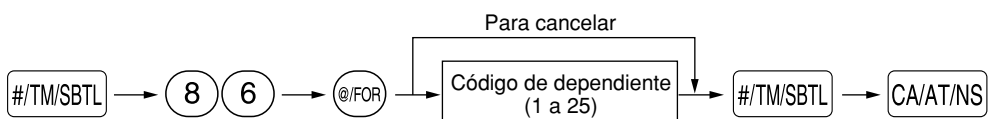

■ Programación de la tecla AUTO — Tecla de secuencia automática —

Si se programan transacciones que se realizan con frecuencia o secuencias de informes para la tecla **AUTO**, puede volver a llamar estas transacciones y/o informes pulsando simplemente la tecla **AUTO** en las operaciones de teclas.

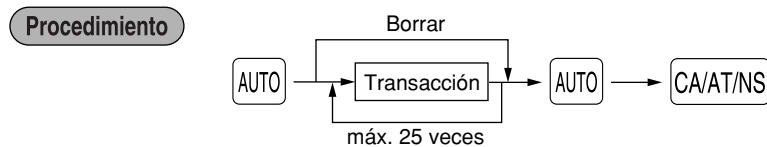

Programación para **AUTO**; registro de un artículo de PLU 2 (precio unitario programado: 1,50) y de un artículo de la sección 6 (precio unitario: 1,00)

Ejemplo de operación de teclas

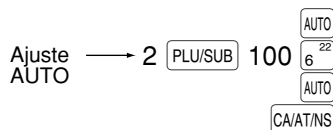

5 Lectura de programas almacenados

La máquina le permitirá leer todos los programas almacenados en el modo PGM.

■ Secuencia de las teclas para la lectura de programas almacenados

Nombre del informe	Secuencia de teclas
Informe de programación 1	CA/AT/NS
Informe de programación 2	2 → CA/AT/NS
Informe de programación de tecla automática	1 → CA/AT/NS
Informe de programación de densidad de impresora	3 → CA/AT/NS
Informe de programación de PLU	Código inicial de PLU → @/PR → Código final de PLU → PLU/SUB

Nota

- Para detener la lectura del informe de programación 1 o del informe de programación de PLU, gire el selector de modo a la posición MGR.
- Cuando se efectúa continuamente la impresión, se interrumpe una vez. Sin embargo, la impresión se reiniciará algunos segundos después.

MODO DE INSTRUCCION

El modo de instrucción se utiliza cuando el operador o el administrador practica las operaciones de la caja registradora.

Cuando se selecciona un dependiente que está en instrucción, la máquina se establece automáticamente en el modo de instrucción. Para especificar un dependiente que deba recibir instrucción, consulte el apartado de "Especificación de dependientes de instrucción para el modo de instrucción" en "PROGRAMACION AVANZADA" en la [página 27](#).

La operación de instrucción sólo es válida en el modo REG, MGR y VOID.

La memoria del dependiente correspondiente sólo se actualiza en el modo de instrucción.

LECTURA (X) Y REPOSICION (Z) DE LOS TOTALES DE VENTAS

- Utilice la función de lectura (X) cuando necesite leer la información de ventas registrada desde la última reposición. Puede obtener esta lectura todas las veces que quiera dado que no afecta a la memoria de la registradora.
- Utilice la función de reposición (Z) cuando necesite borrar la memoria de la registradora. La reposición imprime toda la información de ventas y borra toda la memoria excepto para GT1 a GT3, GT de modo de instrucción, cuenta de reposición y número consecutivo.

1 Resumen de informes de lectura (X) y reposición (Z)

Informes X1 y Z1: Informes de ventas diarias

Informes X2 y Z2: Informes de consolidación periódica (mensual)

Para hacer un informe X o Z, gire el selector de modo a la posición apropiada consultando la columna de "Posición del selector de modo" mostrada en la tabla de la página siguiente, y emplee la siguiente secuencia de teclas correspondiente.

Elemento	Posición del selector de modo			Operación de teclas
	OPX/Z	X1/Z1	X2/Z2	
Informe rápido: (Sólo visualización) Para borrar la visualización, pulse la tecla CL o gire el selector de modo a otra posición.	X	-	-	Código de sección → DEPT# : Total de ventas de sección [Para las secciones 1 a 16; Tecla de sección (1 ¹⁷ a 16 ³²) Para las secciones 17 a 32; DEPTSHIFT → Tecla de sección (1 ¹⁷ a 16 ³²)]
				Tecla @/FOR : Importe de metálico en el cajón
				Tecla CA/AT/NS : Total de ventas
Informe de ventas completo	-	X1, Z1	X2, Z2	Lectura: CA/AT/NS Reposición: • → CA/AT/NS
Informe de dependiente individual	X, Z	-	-	Lectura: CLK# Reposición: • → CLK# (El informe del dependiente actual)
Informe de todos los dependientes	-	X1, Z1	-	Lectura: CLK# Reposición: • → CLK#
Informe de ventas de PLU	-	X1, Z1	-	Lectura: Todas las PLU Código de PLU inicial → @/FOR → Código de PLU final → PLU/SUB Reposición: Todas las PLU Código de PLU inicial → @/FOR → Código de PLU final → • → PLU/SUB
Informe horario	-	X1, Z1	-	Lectura: #/TM/SBTL Reposición: • → #/TM/SBTL

Nota

- Cuando las cantidades de ventas y los importes de ventas son cero, se pasa por alto la impresión. Si no desea que se pase por alto, cambie la programación. (Consulte el apartado de “Formato de impresión” de la sección “Programación 1 de selección de diversas funciones”.)
- “X” representa el símbolo de lectura y “Z” representa el símbolo de reposición en los informes.
- Para dejar de leer y reponer el informe de ventas de PLU, gire el selector de modo a la posición MGR. Los datos no se borrarán al efectuar la reposición.
- Cuando se efectúa continuamente la impresión, se interrumpe una vez. Sin embargo, la impresión se reiniciará algunos segundos después.

LECTURA Y REPOSICION DE INFORMES EJ

La caja registradora está provista de una función de registro diario electrónico (EJ). Esta función sirve para registrar los datos del registro diario en una memoria en lugar de hacerlo en el papel de registro diario, y para imprimir los datos como un informe EJ. La caja registradora registra los datos de registro diario en los modos REG, PGM, VOID, X1/Z1 y X2/Z2. En el ajuste inicial, se pueden almacenar un máximo de 2.000 líneas en la memoria, pero usted podrá ampliarla hasta 3.000 líneas. Para los detalles sobre la programación de EJ, consulte la sección de “Programación del registro diario electrónico” ([página 22](#)).

■ Impresión de los datos del registro diario en forma de una transacción

Podrá imprimir los datos del registro diario de una transacción actual registrada en la memoria EJ pulsando la tecla **RCPTIPO** durante la transacción.

Nota

Esta función es válida cuando se programa el estilo de impresión para recibos, y la función de activación/desactivación (ON/OFF) de recibo se ajusta a OFF (desactivación).

■ Lectura y reposición de los datos del registro diario electrónico (emisión de informe EJ)

Podrá leer los datos del registro diario almacenados en la memoria EJ en el formato del registro diario ejecutando el procedimiento siguiente en el modo X1/Z1 u OP X/Z.

Para leer todos los datos:



Para reponer todos los datos:

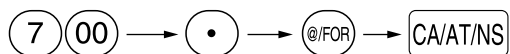

Para leer los 10 registros últimos:

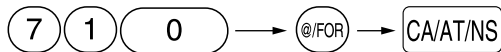

Nota

- Para dejar de leer o reponer los datos, gire el selector de modo a la posición “MGR”. Los datos no se borrarán al efectuar la reposición.
- Cuando se efectúa continuamente la impresión, se interrumpe una vez. Sin embargo, la impresión se reiniciará algunos segundos después.

REGISTROS DE ANULACION

El límite programado para las funciones (tales como importes máximos) puede anularse haciendo un registro de anulación en el modo MGR.

Procedimiento

1. Gire el selector de modo a la posición MGR.
2. Haga el registro de anulación.

CORRECCION DESPUES DE FINALIZAR UNA TRANSACCION (Modo de cancelación)

Cuando necesite cancelar los registros incorrectos que los dependientes no pueden corregir (registros incorrectos que se encuentran después de finalizar una transacción o que no pueden corregirse mediante cancelación directa o indirecta), siga este procedimiento:

1. Gire el selector de modo a la posición VOID empleando la llave del administrador (MA) para establecer la máquina en el modo de cancelación.
2. Repita los registros anotados en el recibo incorrecto. (Todos los datos del recibo incorrecto se suprimirán de la memoria de la registradora y los importes cancelados se añadirán al totalizador de transacción del modo de cancelación.)

MANTENIMIENTO PARA EL OPERADOR

1 En caso de corte de la alimentación

Si se corta la alimentación, la registradora retiene el contenido de su memoria y toda la información sobre las entradas de ventas.

- Cuando el corte de la alimentación ocurre en el estado libre de la registradora o cuando está realizando una entrada, la máquina retorna al funcionamiento normal después de recuperarse la alimentación.
- Cuando el corte de la alimentación ocurre durante un ciclo de impresión, la registradora imprime “=====” y lleva a cabo después el procedimiento de impresión correcto después de recuperarse la alimentación.

2 En el caso de error de impresora

Si se termina el papel de la impresora, se parará la impresora, y aparecerá “PPPPPPPPP” en el visualizador. No pueden aceptarse los registros de teclas. Instale el rollo de papel nuevo, y luego pulse la tecla **CL**.

Si el brazo del rodillo impresor no está bloqueado, se parará la impresora y aparecerá “H” en el extremo izquierdo del visualizador. No pueden aceptarse los registros de teclas. Empuje el brazo hacia abajo hasta que se bloquee con seguridad, y entonces pulse la tecla **CL**. La impresora imprimirá el símbolo de falla de la alimentación y reanudará la impresión.

3 Precauciones al manejar la impresora

- Evite los lugares polvorientos y húmedos, la luz directa del sol y el polvo metálico. (En esta máquina se emplean un imán permanente y un electroimán.)
- No tire nunca del papel cuando esté bloqueado el brazo del rodillo impresor. Levante primero el brazo, y luego quite el papel.
- No toque nunca la superficie del cabezal de impresión ni el rodillo impresor.

4 Reemplazo de las pilas

Esta caja registradora muestra un símbolo de pilas gastadas (L) cuando las pilas están casi gastadas, y visualiza un símbolo de que no hay pilas (L) cuando las pilas están demasiado gastadas o cuando no se han instalado las pilas.

Cuando se visualice el símbolo de pilas gastadas, reemplace las pilas por otras nuevas lo antes posible. Las pilas existentes se gastarán por completo en unos dos días.

Cuando se visualice el símbolo de que no hay pilas, reemplace inmediatamente las pilas. De lo contrario, si se desenchufa el cable de alimentación de CA o si ocurre un corte de la corriente, todos los ajustes programados se repondrán a los ajustes de fábrica y se borrarán los datos almacenados en la memoria.

Nota Asegúrese de observar las precauciones indicadas en la [página 1](#) sobre la manipulación de las pilas.

Para reemplazar las pilas:

1. Asegúrese de que la caja registradora está enchufada.
2. Gire el selector de modo a la posición REG.
3. Extraiga la cubierta de la impresora.
4. Abra la cubierta del compartimiento de las pilas que se encuentra al lado del soporte del rollo de papel y extraiga las pilas gastadas.
5. Instale tres pilas nuevas del tamaño "AA" en el compartimiento de las pilas. Asegúrese de que las polaridades positiva y negativa de cada pila estén encaradas en la dirección adecuada.
Cuando las pilas estén correctamente instaladas, desaparecerá el símbolo " L " o " L ".
6. Cierre la cubierta del compartimiento de las pilas.
7. Vuelva a colocar la cubierta de la impresora.

5 Reemplazo del rollo de papel

Utilice siempre rollos de papel especificados por SHARP.

Si usa otros rollos de papel que no sean los especificados, pueden originarse atascos de papel y funcionar mal la registradora.

(Forma de colocar el rollo de papel)

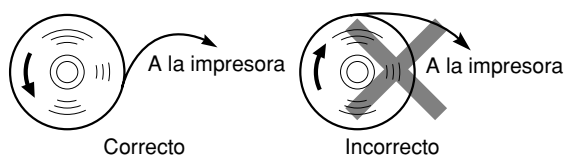

Extracción del rollo de papel

Cuando aparezca tinta de color rojo en el rollo de papel, será indicación de que tiene que cambiarlo. Sustituya el rollo de papel por uno nuevo. Si no piensa utilizar la registradora durante mucho tiempo, extraiga el rollo de papel y guárdelo en el lugar apropiado.

Precaución: El cortador de papel está montado en la cubierta. Tenga cuidado de no cortarse.

Cuando no emplee el carrete de toma:

1. Extraiga la cubierta de la impresora.
2. Levante la palanca de liberación del rodillo impresor para desbloquear y abrir el brazo del rodillo impresor.
3. Extraiga el rollo de papel del soporte del rollo de papel.

Nota No tire del papel por la impresora.

Cuando emplee el carrete de toma:

1. Gire el selector de modo a una posición que no sea la posición OFF con el cable de alimentación enchufado.
2. Extraiga la cubierta de la impresora.
3. Pulse la tecla  para hacer avanzar el papel de registro diario hasta que la parte impresa salga del paso.
4. Corte el papel y extraiga el carrete de toma.
5. Levante la palanca de liberación del rodillo impresor para desbloquear y abrir el brazo del rodillo impresor.
6. Extraiga el rollo de papel del soporte del rollo de papel.
7. Extraiga el lado exterior del carrete de toma.
8. Extraiga el rollo de registro diario impreso del carrete de toma.

■ Instalación del rollo de papel

Precaución: El cortador de papel está montado en la cubierta de la impresora. Tenga cuidado de no cortarse.

1. Gire el selector de modo a una posición que no sea la posición OFF con el cable de alimentación enchufado.
2. Extraiga la cubierta de la impresora.
3. Levante la palanca de liberación del rodillo impresor para desbloquear y abrir el brazo del rodillo impresor.
4. Coloque correctamente el papel en el soporte del rollo de papel.
5. Haga avanzar el extremo del papel junto con las guías de papel.
6. Mientras mantiene retenido el papel, cierre lentamente el brazo del rodillo impresor, y empuje el brazo hacia abajo hasta oír un sonido seco de confirmación. Asegúrese que empuja con seguridad el centro de la parte del ala del brazo. El papel avanzará automáticamente.



Nota

Si el brazo del rodillo impresor no está bloqueado correctamente, no se podrá imprimir con éxito. Si ocurre este problema, abra el brazo, y ciérrelo de nuevo como se ha indicado arriba.

7. Cuando no emplee el carrete de toma (empleo como papel de recibos):

- Corte el papel sobrante empleando el borde de la cubierta interior, y vuelva a colocar la cubierta de la impresora. Pulse la tecla  para asegurarse que el papel sale por la cubierta de la impresora y que aparece papel limpio.

Cuando emplee el carrete de toma (empleo como papel de registro diario):

- Inserte el extremo del papel en la ranura del carrete. (Pulse la tecla  para hacer avanzar más el papel si es necesario.)
- Bobine el papel dos o tres vueltas en torno al eje del carrete.
- Coloque el carrete en el rodamiento, y pulse la tecla  para tensar el papel.
- Vuelva a colocar la cubierta de la impresora.

Nota

Podrá bobinar el papel de rollo en los modos OP X/Z, X1/Z1 y X2/Z2 aunque haya programado para utilizar la impresora para emisión de recibos. Esto puede ser conveniente para bobinar los informes. En este caso, ajuste el papel de rollo en el carrete de toma.

6 Extracción del papel atascado

Precaución: El cortador de papel está montado en la cubierta. Tenga cuidado de no cortarse. No toque nunca el cabezal de impresión inmediatamente después de imprimir, porque éste estará aún caliente.

1. Extraiga la cubierta de la impresora.
2. Levante la palanca de liberación del rodillo impresor para desbloquear y abrir el brazo del rodillo impresor.
3. Extraiga el papel atascado. Compruebe si quedan restos de papel en la impresora y, si los hubiera, quítelos.
4. Ponga correctamente el rollo de papel siguiendo los pasos mencionados en “Instalación del rollo de papel”.

7 Limpieza de la impresora (cabezal de impresión / sensor / rodillo)

Cuando el texto impreso se oscurece o aparece borroso, el polvo del papel puede pegarse en el cabezal de impresión, el sensor y/o el rodillo. Límpielos de la forma siguiente:

Precaución:

- **No toque nunca el cabezal de impresión con una herramienta ni nada que sea duro porque podría estropear el cabezal.**
- **El cortador de papel está montado en la cubierta de la impresora. Tenga cuidado de no cortarse.**

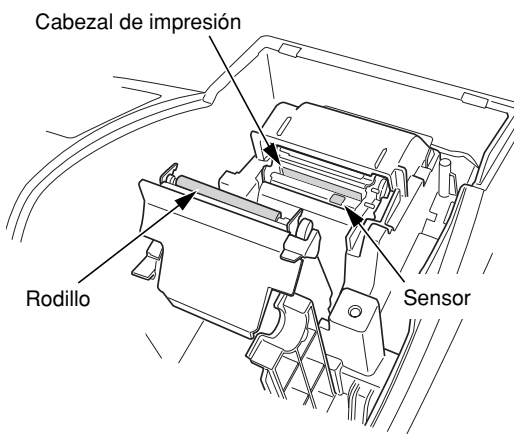

1. Gire el selector de modo a la posición OFF.
2. Extraiga la cubierta de la impresora.
3. Levante la palanca de liberación del rodillo impresor para desbloquear y abrir el brazo del rodillo impresor.
4. Extraiga el rollo de papel consultando la sección "Extracción del rollo de papel".
5. Limpie el cabezal de impresión con un palillo de algodón o un paño blando humedecido en alcohol etílico o alcohol isopropílico. Limpie el rodillo y el sensor de la misma manera.
6. Ponga correctamente el rollo de papel siguiendo los pasos mencionados en "Instalación del rollo de papel".

8 Extracción del cajón

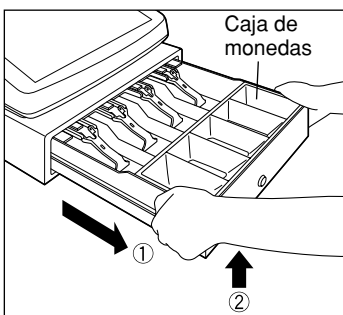

El cajón de la caja registradora es extraíble. Después de terminar la jornada laboral, extraiga el cajón. Para extraer el cajón, tire del mismo completamente hacia delante y extráigalo levantándolo. La caja de monedas de 5 denominaciones también es extraíble.

9 Abertura manual del cajón

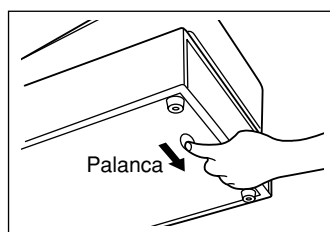

El cajón se abre automáticamente. Sin embargo, cuando haya un fallo o corte de la corriente o la registradora quede fuera de servicio, deslice la palanca situada en la parte inferior de la registradora en la dirección de la flecha. (Vea la figura a la izquierda.)

El cajón no se abrirá, sin embargo, si está cerrado con la llave.

10 Antes de solicitar el servicio de un técnico

Los casos de mal funcionamiento de la columna de la izquierda de la tabla siguiente, indicados bajo el título "Fallo", no son necesariamente averías de la registradora. Se recomienda pues consultar la sección "Comprobación" de la columna de la derecha antes de llamar al servicio técnico.

Fallo	Comprobación
(1) El visualizador muestra los símbolos que no tienen ningún sentido.	<ul style="list-style-type: none"> ¿Se ha inicializado correctamente la máquina como se muestra en "PARA EMPEZAR"? (Tenga presente que la inicialización borra todos los datos y ajustes programados que están almacenados en la memoria.)
(2) El visualizador no se ilumina aunque el selector de modo esté colocado en cualquier otra posición que no sea "OFF".	<ul style="list-style-type: none"> ¿Se suministra alimentación en la toma de corriente? ¿Está la clavija del cable de alimentación desenchufada o mal conectada a la toma de corriente?
(3) El visualizador se ilumina, pero la registradora no responde a los registros.	<ul style="list-style-type: none"> ¿Está el código del dependiente asignado a la registradora? ¿Está el selector de modo bien colocado en la posición "REG"?
(4) No se emiten recibos.	<ul style="list-style-type: none"> ¿Está el rollo de papel bien instalado? ¿Hay algún atasco de papel? ¿Está la función de recibos en el estado "OFF"? ¿Está la palanca de liberación del rodillo impresor bloqueado con seguridad?
(5) No sale el papel del registro diario.	<ul style="list-style-type: none"> ¿Está el carrete de toma bien instalado en el rodamiento? ¿Hay algún atasco de papel? ¿Se ha seleccionado la impresión del registro diario en la programación del estilo de impresión? (Si se ha seleccionado la impresión de recibos, el papel no se bobinará en torno al carrete de toma.)
(6) La impresión no es normal.	<ul style="list-style-type: none"> ¿Está la palanca de liberación del rodillo impresor bloqueado con seguridad? ¿Está el rollo de papel correctamente instalado? ¿Están limpios el cabezal de impresión/sensor/rodillo?

■ Tabla de códigos de error

Cuando se visualicen los siguientes códigos de error, pulse la tecla **CL** y tome la acción apropiada de acuerdo con la tabla siguiente.

Código de error	Estado de error	Acción
E01	Error de registro	Haga el registro con las teclas correctas.
E02	Error de operación incorrecta	Haga el registro con las teclas correctas.
E03	Se ha introducido un código no definido.	Introduzca un código correcto.
E07	La memoria está llena (en la programación de la tecla AUTO).	Programe la tecla AUTO con 25 pasos.
E11	Pulsación obligatoria de la tecla #/TMSBTL para finalización directa	Pulse la tecla #/TMSBTL y prosiga la operación.
E12	Importe recibido obligatorio	Efectúe una operación de importe recibido.
E32	Falta el registro de un código de dependiente.	Efectúe un registro de código de dependiente.
E34	Error de límite de rebose	Haga el registro dentro del límite de registro.
E35	La entrada de precio abierto está inhibida.	Haga un registro de precio preajustado.
E36	La entrada de precio preajustado está inhibida.	Haga un registro de precio abierto.
E37	La finalización directa está inhibida.	Haga una operación de importe recibido.
E67	No se permite la cancelación del subtotal.	Finalice la transacción y corrija las entradas erróneas en el modo de cancelación.

Emplee estas etiquetas con las teclas de sección. Escriba los nombres de sección en las etiquetas y adhiéralas a las teclas de sección sacando primero las cubiertas transparentes de las teclas. (Haga una copia de esta página.)

Ejemplo:

17
Leche

Pan
1 E

18

2 D

22

6 I

26

10 N

30

14 S

20

4 B

24

8 G

28

12 L

32

16 Q

17

1 E

21

5 J

25

9 O

29

13 T

19

3 C

23

7 H

27

11 M

31

15 R

LIMITED WARRANTY

SHARP ELECTRONICS CORPORATION warrants to the first consumer purchaser that this Sharp brand product (the "Product"), when shipped in its original container, will be free from defective workmanship and materials and agrees that it will, at its option, either repair the defect or replace the defective Product or part thereof at no charge to the purchaser for parts or labor for the time period(s) set forth below.

This warranty does not apply to any appearance items of the Product nor to the additional excluded item(s) set forth below nor to any product the exterior of which has been damaged or defaced, which has been subjected to misuse, abnormal service or handling or which has been altered or modified in design or construction.

In order to enforce the rights under this limited warranty, the purchaser should follow the steps set forth below and provide proof of purchase to the servicer.

The limited warranty described herein is in addition to whatever implied warranties may be granted to purchasers by law. ALL IMPLIED WARRANTIES INCLUDING THE WARRANTIES OF MERCHANTABILITY AND FITNESS FOR USE ARE LIMITED TO THE PERIOD(S) FROM THE DATE OF PURCHASE SET FORTH BELOW. Some states do not allow limitations on how long an implied warranty lasts, so the above limitation may not apply to you.

Neither the sales personnel of the seller nor any other person is authorized to make any warranties other than those described herein or to extend the duration of any warranties beyond the time period described herein on behalf of Sharp.

The warranties described herein shall be the sole and exclusive warranties granted by Sharp and shall be the sole and exclusive remedy available to the purchaser. Correction of defects, in the manner and for the period of time described herein, shall constitute complete fulfillment of all liabilities and responsibilities of Sharp to the purchaser with respect to the Product and shall constitute full satisfaction of all claims, whether based on contract, negligence, strict liability or otherwise. In no event shall Sharp be liable, or in any way responsible, for any damages or defects in the Product which were caused by repairs or attempted repairs performed by anyone other than an authorized servicer. Nor shall Sharp be liable, or in any way responsible, for any incidental or consequential economic or property damage. Some states do not allow the exclusion or incidental or consequential damages, so the above exclusion may not apply to you.

THE WARRANTY GIVES YOU SPECIFIC LEGAL RIGHTS. YOU MAY ALSO HAVE OTHER RIGHTS WHICH VARY FROM STATE TO STATE.

<u>Your Product:</u>	XE series Electronic Cash Register
<u>Warranty Period of this Product:</u>	One (1) year for parts and ninety (90) days parts and labor from the date of purchase.
<u>Additional items excluded from warranty coverage:</u>	Any consumable items such as paper supplied with the Product.
<u>Where to obtain service:</u>	At a Sharp Authorized Servicer located in the United States. To find the location of the nearest Sharp Authorized Servicer, call toll free at 1-800-BE-SHARP.
<u>What to do to obtain service:</u>	Ship (prepaid) or carry your Product to a Sharp Authorized Servicer. Be sure to have proof of purchase available. If you ship or mail the Product, be sure it is packaged carefully.

TO OBTAIN SUPPLIES, ACCESSORIES OR PRODUCT INFORMATION, CALL 1-800-BE-SHARP.

SHARP®

SHARP ELECTRONICS CORPORATION

Sharp Plaza, Mahwah, New Jersey 07430-2135

1-800-BE-SHARP

For additional information and product registration,
please visit www.sharpusa.com

SHARP CORPORATION