

CR-4000 SERIES CASH DRAWER USER' S MANUAL

Rev. : C

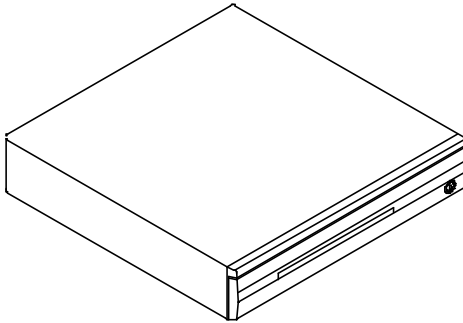

NOTICE

The manufacturer of the POS cash drawer makes no representation or warranties, either expressed or implied, by or with respect to anything in this manual, and shall not be liable for any implied warranties of fitness for a particular purpose or for any indirect, special or consequential damages. Information in this document is subject to change without notice and does not represent a commitment on the part of the manufacturer.

FCC NOTICE

This equipment generates, uses, and can radiate radio frequency energy and if not installed and used in accordance with the instructions manual, may cause interference to radio communications. It has been tested and found to comply with the limits for a Class A digital device pursuant to Subpart J of Part 15 of FCC Rules, which are designed to provide reasonable protection against interference when operated in a commercial environment. Operation of this equipment in a residential area is likely to cause interference in which case the user at his own expense will be required to take whatever measures may be required to correct the interference.





MODEL NUMBERS

Model	CR400X	CR410X	CR421X
Bill Compartment	5 Adjustable	5 Fixed	5 Fixed
Bill clip	Plastic	Metal	Metal
Coin compartment	9 Fixed	9 Fixed	5 Fixed
Coin Roll storage	1 Underneath Cash Tray		4 Behind Cash Tray

INTERFACE APPLICATION

Model Number	Interface	Security Code	Power / Source
CR-4000/4100/4210	Printer drive	N. A.	12/24 V Pulse / Printer
CR-4001/4101/4211	Dedicated RS232 serial	N. A.	12VAC / Adaptor
CR-4002/4102/4212	Non-dedicated RS232 serial	0 ~ 255	
CR-4003/4103/4213	Parallel	0 ~ 255	
CR-4004/4104/4214	Dedicated RS232 serial	N. A.	12VDC / PC
CR-4005/4105/4215	USB	USB PID	12VAC / Adaptor
CR-4005-II/4105-II/4215-II	USB	USB PID	12VAC / Adaptor

CARTON CONTENTS

1. Cash drawer pre-assembled.
2. User's manual.
3. Separators of bill compartment: 4 pcs (for CR4000~5 and CR4005-II only).
4. Key 2pcs: There is a key serial No. sticker on the cash drawer bottom plate. If user lost the key he/she can order the key according to this number.
5. Signal Cable depend on model
 - a). For CR4000/4100/4210: The standard signal cable is CCBLA-180 (or CCBLA-180-1) which has a 8 pin plug at one end to connect to the cash drawer and a 6 pin plug at the other end to connect to the POS system/printer. This cable serves for most popularly used POS equipment such as all Posiflex POS terminals, all Posiflex POS printers, most. Epson POS printers, most Star POS printers and all other compatibles. The user may cut the 6 pin end or order the ready cut cable CCBLA-180A and assemble this free end according to his POS printer specification if the POS printer used applies different connection. The cable connection on. CCBLA-180A is as below:

Wire color	RJ45	Function
Red	Pin 1	Drawer open sense
Blue	Pin 2	Drawer open sense return
Green	Pin 7	+ 24V to solenoid
Yellow	Pin 8	Drawer kick pulse

- b). For CR4001/ 4101/ 4211/ 4002/ 4102/ 4212: CCBLA-196A with one 9PM and one 9PF connector.
 - c). For CR4003/ 4103/ 4213: CCBLA-089-1 with one 25PM and one 25PF connector.
 - d). For CR4004/ 4104/ 4214: The serial signal cable is already built on.
 - e). For CR4005/ 4105/ 4215/ CR4005-II/ 4105-II/ 4215-II: USB cable is already built on.
6. Power Source depend on model
- a). For CR-4000/ 4100/ 4210: not applicable
 - b). For CR-4001/ 4101/ 4211/ 4002/ 4102/ 4212/ 4003/ 4103/ 4213/ 4005/ 4105/ 4215 / CR4005-II / 4105 -II/ 4215-II: Power adapter 12VAC 1.5A
 - c). For CR4004/ 4104/ 4214: Power connector cable and I/O bracket plate.

INSTALLATION

CR4000 / 4100 / 4210 Connect the drawer to POS system/printer as shown below:

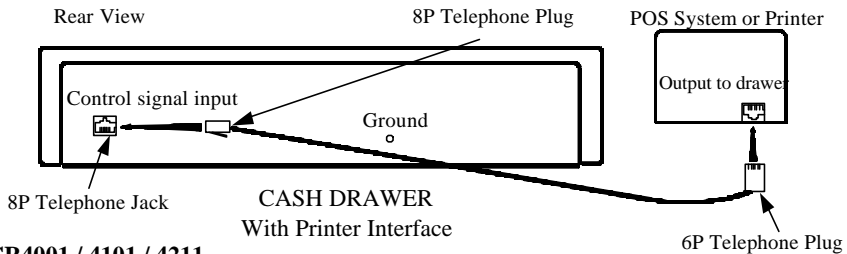

CR4001 / 4101 / 4211

- 1). Connect the drawer serial I/P port to the computer COM port. Connect the power adapter output to the Power Input jack
- 2). No other RS232C devices should be connected to the serial O/P port.
- 3). Set position 3 of S2 to OFF and position 4 of S2 to ON. Please refer to rear panel illustration.

CR4002 / 4102 / 4212

- 1). Connect the drawer serial I/P port to the computer COM port. Connect the power adapter output to the Power Input jack.
- 2). Other RS232C device can be connected to the serial O/P port when needed as long as the security code makes no influence to this RS232C device.
- 3). Set position 3 of S2 to ON and position 4 of S2 to OFF. Set S1 for security code to open cash drawer. In normal practice, the security code is suggested to be a non-displayable ASCII character, for example, a hexadecimal number between 01 to 1F. Please refer to rear panel illustration below.

CR4003 / 4103 / 4213

- 1). Connect the drawer parallel I/P port to the computer LPT port. Connect the power adapter output to the Power Input jack.
- 2). Other parallel device such as a printer can be connected to the parallel O/P port when needed as long as the Security code makes no influence to this parallel device.

- 3). Set S1 for security code to open cash drawer. In normal practice, the security code is suggested to be a non-displayable ASCII character. For example, a hexadecimal number between 01 to 1F. Please refer to rear panel illustration below.

CR4001/ 4101/ 4211/ 4002/ 4102/ 4212/ 4003/ 4103/ 4213 Rear panel illustration.

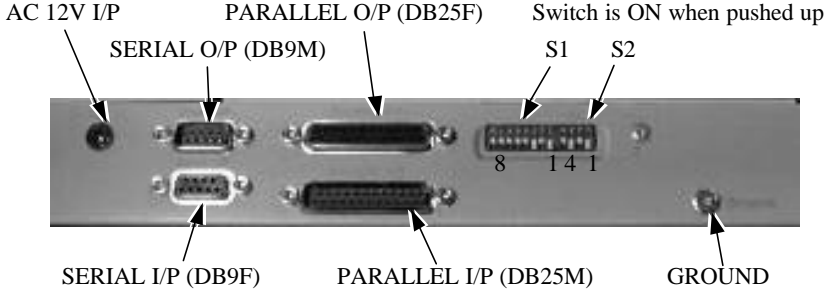

- S1** Set security code. (Default Setting: BIT 1,2,3 OFF and BIT 4,5,6,7,8 ON. Security code is 07H)

BIT	1	2	3	4	5	6	7	8
Number to be added to the security code if OFF.	1	2	4	8	16	32	64	128

- S2** BIT1 ON and BIT2 OFF to receive security code via Pin2 of P4 (DB9F).
 BIT1 OFF and BIT2 ON* to receive security code via Pin3 of P4 (DB9F).
 BIT3 OFF and BIT4 ON for dedicated RS-232C.
 BIT3 ON and BIT4 OFF* for non-dedicated RS-232C.
 (*denotes factory default setting)

CR4004 / 4104 / 4214

- 1). Open the PC case. Put the metal bracket with power connector into one of the I/O windows.
- 2). Connect the cable to the **HDD** type power connector of PC power supply. See illustration below. Then close the PC case.
- 3). Connect the DB-9 connector to the computer's serial port of COM1 (or COM2). Connect the 4P phone plug connector to the added I/O bracket. See below illustration.

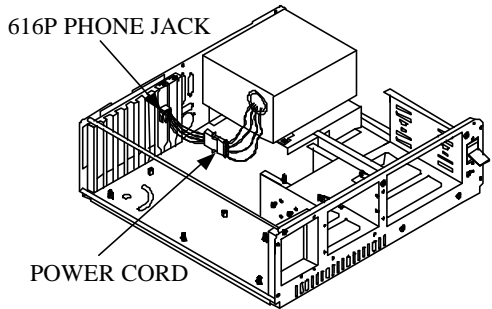

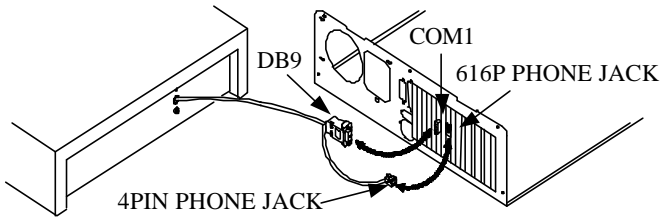

CR4005/ 4105/ 4215/ CR4005-II/ 4105-II/ 4215-II

- 1). Define a drawer number for the cash drawer so that this cash drawer is going to respond accordingly in USB communication. Follow the table below for SWITCH SETTING to adjust the switch S1 according to this drawer number if it is not 7. Please note that within each system there should never be any 2 USB interface cash drawers carrying the same drawer number.

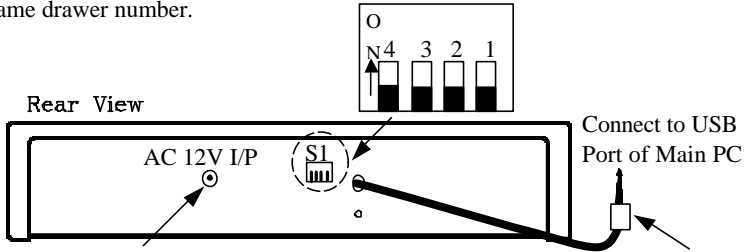

Power Jack of CR4005/4105/4215/ CR4005-II/ 4105-II/ 4215-II USB Connector from CR4005/4105/ 4215/CR4005-II/ 4105-II/ 4215-II

Rear View of Model CR4005/4105/ 4215/CR4005-II/ 4105-II/ 4215-II Cash Drawer with USB Interface

SWITCH SETTING:

Drawer	0	1	2	3	4	5	6	7
SW1	ON	OFF	ON	OFF	ON	OFF	ON	OFF
SW2	ON	ON	OFF	OFF	ON	ON	OFF	OFF
SW3	ON	ON	ON	ON	OFF	OFF	OFF	OFF
SW4	Reserved							

Default setting: Drawer 7 (SW1: OFF; SW2: OFF; SW3: OFF)

- 2). Connect USB connector of cable coming out from the rear side of the USB interface cash drawer to USB port of main PC.
- 3). Check the specification of power adaptor on its nameplate. Insert the power adaptor into the correct power outlet. Insert the output plug to the jack at rear side of CR4005/ 4105/ 4215/ CR4005-II/ 4105-II/ 4215-II to supply power for drawer kickout.
- 4). Install the USB utility driver from Posiflex Product Information CD with Posiflex POS system or visit our web sites <http://www.posiflex.com.tw> or <http://www.posiflextw.com> or <http://www.posiflexusa.com> for latest updates.

UPOS driver application (Applied for all Posiflex cash drawer)

Please first find in Posiflex Product Information CDROM or download from Posiflex web sites for UPOS driver setup. In this application CR4XX3 and CR4XX4 respond to openDrawer command only; CR4XX0, CR4XX1 and CR4XX2 are compliant to UPOS version 1.4; CR4XX5 are compliant to UPOS version 1.7 and CR4XX5-II are compliant to UPOS version 1.8.

FUNCTIONAL TEST

CR4000 / 4100 / 4210

1. Follow the printer's manual of the printer the cash drawer is connected to open cash drawer.
2. If the cash drawer is connected to a Posiflex POS system, follow the technical instruction of the system to open the cash drawer.

CR-4001 / 4101 / 4211 / 4002 / 4102 / 4212 / 4004 / 4104 / 4214

1. Under DOS prompt, type "MODE COM1 96 N 8 1". Hit the **ENTER** key.
2. Type "TYPE CON>COM1". Hit the **ENTER** key.
3. Type "CTRL-G" (Press Ctrl and G keys together). Hit the **ENTER** key, then the drawer will open.
4. Hit **CTRL-C** (Press Ctrl and C keys together) to return the computer back to the normal display mode.

In case the cash drawer is connected to serial port other than COM1 please substitute COM1 above to proper port name.

If the pre-set security code of CR-4002/ 4102/ 4212 has been changed from default 07 Hex. Please change the CTRL-G above accordingly. For CR4001/ 4101/ 4211/ 4004/ 4104/ 4214, this code can be replaced by any character.

CR-4003 / 4103 / 4213

1. Under DOS prompt, type "TYPE CON>LPT1". Hit the **ENTER** key.
2. Type "CTRL-G" (Press Ctrl and G keys together). Hit the **ENTER** key, then the drawer will open.
3. Hit **CTRL-C** (Press Ctrl and C keys together) to return the computer back to the normal display mode.

If the pre-set security code of CR-4003/ 4103/ 4213 has been changed from default 07 Hex. Please change the CTRL-G above accordingly.

CR4005/ 4105/ 4215/ CR4005-II/ 4105-II/ 4215-II

1. Please find in Posiflex Product Information CDROM or go to Posiflex web sites (<http://www.posiflex.com.tw> or <http://www.posiflextw.com> or <http://www.posiflexusa.com>) for USB Cash Drawer Test Program. If you use the Posiflex Product Information CDROM that comes with any Posiflex POS system, please go to folder "\\Drivers\CR\USB" and click "SETUP.EXE" to install the USB Cash Drawer Test Program.



2. Start up the test program and click “STATUS” button. The drawer status of Open/Close or Not present will be displayed under each drawer number as “O”, “C” or “N”
3. Use a key to turn the lock to standby position (the one marked with sign at middle), click the check only the box (es) under the drawer number(s) for the drawer(s) to be tested then click the “KICK” button.
4. The cash drawer will then open and the Open/Close/Not present status of the tested drawer number will be renewed accordingly. If these status are correct, the USB interface cash drawer passes the test.

SPECIFICATIONS

MECHANICAL: Dimensions: 428 (W) x 460 (D) x 100 (H) mm

Weight: 6.0 Kgs

Removable tray with a lock-on cover (option)

ELECTRICAL:

Power Source

Solenoid Drive (for CR-4000 / 4100 / 4210)

Pulse Amplitude 12 to 24 VDC

Pulse Width 100 to 250 msec

Pulse Duty Cycle 10% max.

Max. Current Consumption 0.75A @ 12 VDC/1.5A @ 24 VDC

AC Adaptor (for CR-4001/ 4101/ 4211/ 4002/ 4102/ 4212/ 4003/ 4103/ 4213/ 4005/ 4105/ 4215/ 4005-II/ 4105-II/ 4215-II)

Input Voltage 120 VAC \pm 10 % / 240 VAC \pm 10 % @50 -60 Hz

Output Voltage 12 VAC at 1.5 A

DC Power Kit (for CR-4004 / 4104 / 4214): +12 V DC and + 5 V DC

Interface

Direct Drive: CR4000/ 4100/ 4210

Serial (RS232C)

	CR-4001	CR-4002	CR-4004
	CR-4101	CR-4102	CR-4104
	CR-4211	CR-4212	CR-4214
Baud rate	9600	9600	150 ~ 19200
Parity	None	none	none, even, or odd
Data Bits	8	8	7 or 8
Stop Bits	1 or 2	1 or 2	1 or 2

Parallel (IEEE1284): CR-4003/ 4103/ 4213

USB (1.1): CR-4005/ 4105/ 4215/ 4005-II/ 4105-II/ 4215-II

Security Code

CR-4002/ 4102/ 4212/ 4003/ 4103/ 4213

1-255; factory preset value = 7

CR-4005/ 4105/ 4215/ 4005-II/ 4105-II/ 4215-II

USB PID

Drawer Open Sense

CR-4000/ 4100/ 4210

Drawer open sense circuit shorts when open

CR-4001/ 4101/ 4211/ 4002/ 4102/ 4212

Pin 9 shorts to pin 5 when drawer open

CR-4005/4105/4215/4005-II/4105-II/4215-II

Through USB driver

KEYLOCK OPERATION

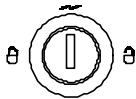

- ⊖ : Physically lock the drawer.
- ⊕ : Open the drawer by the key.
- ⊖⊕ : Automatically open the drawer by POS printer or POS system or interface signal control

Keylock

STRUCTURE

Check Slot



Inside CR-4000/ 4001/ 4002/ 4003/ 4004/ 4005/ 4005-II/ 4100/ 4101/ 4102/ 4103/ 4104/ 4105/ 4105-II

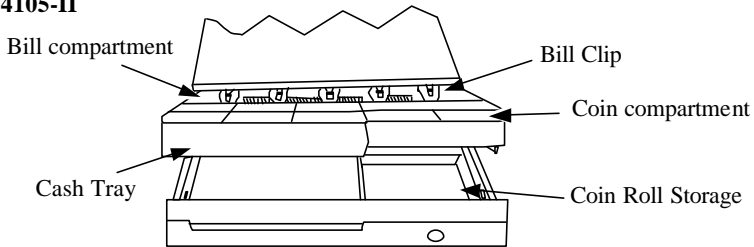

Tray for CR-4210/ 4211/ 4212/ 4213/ 4214/ 4215/ 4215-II

