

Instruction Manual

Underwater Case

PT-023

For the digital camera
CAMEDIA C-8080 Wide Zoom

- Thank you for buying the Underwater Case PT-023.
- Please read this instruction manual carefully and use the product safely and correctly.
- Please keep this instruction manual for reference after reading it.
- Wrong use may cause damage to the camera on the inside from water leakage, and repair may not be possible.
- Before use, perform an advance check as described in this manual.

OLYMPUS CORPORATION

Disclaimer

- Unauthorised copying of this manual in part or in full, except for private use, is prohibited. Unauthorised reproduction is strictly prohibited.
- OLYMPUS CORPORATION shall not be responsible in any way for lost profits or any claims by third parties in case of any damage occurring from incorrect use of this product.
- OLYMPUS CORPORATION shall not be responsible in any way for damage, lost profits, etc. caused by the loss of image data due to defects, disassembly, repair or modification of this product by people, other than third parties specifically authorised by OLYMPUS CORPORATION or for other reasons.

Please read the following before using the product

- This product has been precision-crafted from high quality polycarbonate. When used correctly, it lets you take photographs safely up to a water pressure equivalent to a depth of 40 metres.
- To ensure correct and safe use of the case, please read all instructions on handling and carrying out the system check as well as care, maintenance and storage of the case.
- OLYMPUS CORPORATION shall in no way be responsible for damage caused by water to the camera contained in the case.
- OLYMPUS CORPORATION shall not pay any compensation for accidents (injuries or material damage) that happen during the use of this product.

For safe use

This instruction manual uses various pictographs for correct use of the product and to prevent danger to the user and other persons as well as property damage. These pictographs and their meanings are shown below.

 **WARNING** This indicates contents for which the possibility of human death or severe injury in case of handling under disregard of this indication can be assumed.

 **CAUTION** This indicates contents for which the possibility of human injury or the possibility of material damage in case of handling under disregard of this indication can be assumed.

⚠ WARNING

1. Keep this product out of the reach of babies, infants, and children. There is the possibility of occurrence of the following types of accidents.
 - Injury by dropping onto the body from a height.
 - Injury from parts of the body getting caught in parts which open and close.
 - Swallowing of small parts. Please consult a physician immediately if any parts have been swallowed.
 - Triggering of the flash in front of the eyes may cause permanent vision impairment etc.
2. Do not store with a battery in the digital camera housed in this product. Storage with a battery inserted may lead to leakage of the battery liquid and fire.
3. If leakage of water should occur with a camera installed in this product, quickly remove the battery from the camera. There is the possibility of ignition and explosion from generation of hydrogen gas.
4. This product is made of resin. There is the possibility that injuries may be caused when it becomes broken because of strong impact with a rock or other hard objects. Please handle with sufficient care.
5. The silica gel and the grease for silicone O-rings for this product are not edible.

⚠ CAUTION

1. Do not disassemble or modify this product. This may cause water leakage or trouble. In case of disassembly or modification by persons other than those appointed by OLYMPUS CORPORATION, the guarantee shall not apply.
2. Do not place this product at locations with abnormally high or abnormally low temperatures or at locations with extreme temperature changes. The product may deteriorate.
3. Opening and closing at locations with much sand, dust, or dirt may impair the waterproof characteristic and cause water leakage. This should be avoided.
4. This product has been designed and manufactured for use at a water depth within 40 m. Please note that diving to a depth in excess of 40 m may cause permanent deformation or damage to the Case and the camera inside the Case or may lead to water leakage.

5. Rough handling, such as jumping into the water with the case in your hand or in an outside pocket or throwing the case into the water, etc. could lead to water leakage. Please always take care when using the case.
6. If the camera contained in the case becomes wet because of water leakage, etc., immediately wipe off all moisture and check the camera is working correctly.
7. Before travelling by air, please make sure you remove the O-ring, otherwise the difference in air pressure may make it impossible to open the case.
8. To ensure safe and trouble-free handling and operation of the digital camera in this product, please read the camera's instruction manual carefully.
9. When sealing this product, please take care to ensure no foreign matter such as sand, dirt or hair are on the O-ring or contact surfaces.

Batteries

- Use an exclusive lithium-ion battery (Olympus BLM-1) designed for digital cameras.
- Keep the battery's contacts away from damp or humidity; otherwise this could impair performance and/or cause accidents.
- For additional battery cautions, refer to your digital camera's instruction manual.
- The Power Battery Holder for the C-8080 Wide Zoom (optional B-HLD30) cannot be used with this product.

For Prevention of Water Leakage Accidents

When water leakage occurs while this product is being used, repair of the camera housed in this product may become impossible. Please observe the following cautions for use.

1. When sealing this product, make sure that no hairs, fibers, sand particles or other foreign matter stick not only to the O-ring, but also to the contact surface. Even a single hair or a single grain of sand may cause water leakage. Please check with special care.

Examples for foreign matter sticking to the O-ring

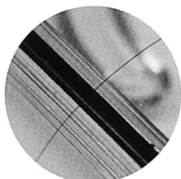

Hair



Fibers

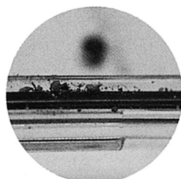

Grains of sand

2. The O-ring is a consumption product. Please replace it at least once a year by new one. Also perform maintenance for every use.
3. Deterioration of the O-ring will progress according to the use conditions and the storage conditions. Immediately replace the O-ring by a new one if it is damaged, shows cracks, or has lost its elasticity.
4. At the time of O-ring maintenance, clean the inside of the O-ring groove and confirm the absence of dirt, dust, sand, and other foreign matter.
5. Apply the specified silicone O-ring grease to the O-ring.
6. The waterproof function is not effective when the O-ring is not installed correctly. When installing the O-ring, take care that it does not project from the groove and that it is not twisted. Also, when sealing the Case, close the lid after confirming that the O-ring has not come out of the groove.
7. This product is an airtight construction made of plastic (polycarbonate). When it is left for a long time in a car, on a boat, at the beach, or at other places reaching a high temperature, or when it is subjected for a long time to uneven external force, it may be deformed and the waterproof function may be lost. Pay sufficient attention to temperature control. Also do not place heavy objects onto the product during storage or transport, and avoid unreasonable storage.
8. When the O-ring contact surface is pressed strongly from the

outside of the Case, or when the Case is twisted, the waterproof function may be lost. Take care not to exert excessive force.

9. Please be sure to perform the advance test and the final test each time before using the case.
10. If you should notice drops of water or other signs of water leakage while taking pictures, immediately stop the dive, remove any water from the camera and the product, test according to the item "Final check", and confirm whether leakage has occurred or not.

Handling the Product

- Use or storage of the product at the following locations may cause defective operation, defects, trouble, damage, fire, internal clouding, or water leakage. Always avoid these locations.
 - Places where high temperatures exist, such as in direct sunlight, in a closed vehicle, etc., and/or where extreme differences in temperatures exist.
 - Places where there is a lot of dust.
 - Places where there are open fires.
 - Places subject to vibrations.
 - Places where volatile chemicals are stored or used.
 - Water deeper than 40 meters.
- This product is made of polycarbonate resin with excellent impact resistance, but it may be damaged by scraping against rocks etc. It also may break when it hits hard objects or is dropped.
- This product is not a case to soften impacts to the camera inside the product. When this product with a digital camera inside it is subjected to impacts or heavy objects are placed onto it, the digital camera may become damaged. Please handle the product with sufficient care.
- When the product is not used for a long time, the waterproof performance may drop because of deterioration of the O-ring etc. Before use, always perform the advance test and the final check.
- Do not apply excessive force to the port mount, TTL cable connector, diffusion plate, tripod socket, etc.
- When a flash is used while the Case is being used, shadows may appear at the edges of the picture. This is especially notable when taking pictures in macro mode on the wide-angle side. Please use a flash after image confirmation.
- Do not use the following chemicals for cleaning, corrosion prevention, prevention of fogging, repair or other purposes. When these are used for the Case directly or indirectly (with the chemicals in vaporized state), they may cause cracking under high pressure or other problems.

Chemicals which cannot be used	Explanation
Volatile organic solvents, chemical detergents	Do not clean the Case with alcohol, gasoline, thinner or other volatile organic solvents or with chemical detergents etc. Pure water or lukewarm water is sufficient.
Anticorrosion agent	Do not use anticorrosion agents. The metal parts use stainless steel or brass, and washing with pure water is sufficient.
Commercial defogging agents	Do not use commercial defogging agents. Always use the specified desiccant silica gel.
Grease other than specified silicone grease	Use only the specified silicone grease for the silicone O-ring, as otherwise the O-ring surface may deteriorate and water leakage may be caused.
Adhesive	Do not use adhesive for repairs or other purposes. When repair is required, please contact a dealer or a service station of our company.

- Do not perform operations other than specified in this instruction manual, do not remove or modify parts other than specified, and do not use parts other than specified.
Any troubles in taking pictures or with the equipment resulting from the above actions shall be outside the guarantee.
- OLYMPUS CORPORATION shall be in no way responsible for accidents involving immersion of a digital camera in water.
- OLYMPUS CORPORATION shall not pay any compensation for accidents (injury or material damage) at the time of use.
- When the enclosure of the balance weight breaks, the metal on the inside may corrode. Take care not to damage the enclosure.
- After use, wash the balance weight with pure water and wipe off all moisture sufficiently.

Contents

Disclaimer	E-1
Please read the following before using the product	E-1
For safe use	E-1
Batteries	E-3
For Prevention of Water Leakage Accidents.....	E-4
Handling the Product.....	E-5
Contents	E-7-8
1. Preparations	E-9
Check the contents of the package.	E-9
Names of the parts.....	E-10
Install the strap.....	E-11
Master the basic operation.	E-11
Holding the Case	E-11
How to Press the Shutter	E-12
How to Use the Mode Dial	E-12
How to Use the Zoom Lever	E-12
Setting the Zoom Lever	E-13
Power Switch Button Operation Method	E-13
Popping up the Flash	E-13
Removing/attaching the standard port.....	E-14
Detaching/attaching the diffusion plate	E-15
Removing the TTL cable connector cap	E-16
Removing the hot shoe cable cap	E-17
Cleaning the TTL connector.....	E-18
2. Advance Check of the Case	E-18
Advance test before use	E-18
Making sure the case is waterproof	E-18
Advance Test	E-19
3. Install the digital camera.	E-20
Check the digital camera.....	E-20
Battery Confirmation	E-20
Confirmation of the Remaining Number of Pictures to be Taken.....	E-20
Removing the carrying strap and lens cap from the digital camera.....	E-20
Removing the filter from the digital camera	E-20
Setting the camera mount on the digital camera.....	E-21
Loading in the Case	E-21
Which digital cameras can be loaded?	E-21
Check the operation of the camera.	E-21
Open the Case.	E-21
Lifting the mode dial knob	E-21
Load the digital camera.	E-22

Fitting the mode dial knob	E-22
Insertion of silica gel	E-22
Check the loading status.	E-23
Seal the Case	E-23
Install the special balance weight.....	E-24
Installation and Removal of the LCD Hood	E-24
Installation	E-24
Removal.....	E-24
Mounting and Removing the Lens Cap.....	E-25
Perform the final checks.	E-25
Visual Inspection	E-25
Setting the camera power to ON and OFF.	E-25
Try to move the mode dial.	E-25
Final Test	E-26
4. Taking Pictures Under Water	E-27
How to Use the Hand Strap	E-27
Take pictures carefully.	E-27
Confirm the picture on the LCD monitor.	E-27
Quietly press the shutter lever.	E-27
Caution when using the flash.....	E-27
5. Handling After Shooting	E-28
Wipe off any waterdrop.	E-28
Take out the digital camera.	E-29
Wash the Case with pure water.	E-30
Dry the Case.	E-30
6. Maintaining the Waterproof Function	E-31
Remove the O-ring.....	E-31
Remove any sand, dirt, etc.	E-31
Install the O-ring.	E-32
How to Apply Grease to the O-ring	E-32
Maintenance of the threaded sections on the	
TTL cable and TTL cable connector	E-33
Maintenance of the TTL Connector Cap	E-33
Replace consumable products.	E-34
7. Appendix	E-35
Q & A on the use of the PT-023	E-35
After-sale Service	E-40
Specifications	E-41
Diver's Insurance Guide	E-41

1. Preparations

Check the contents of the package.

Check that all accessories are in the box.

Contact your dealer if accessories should be missing or damaged.

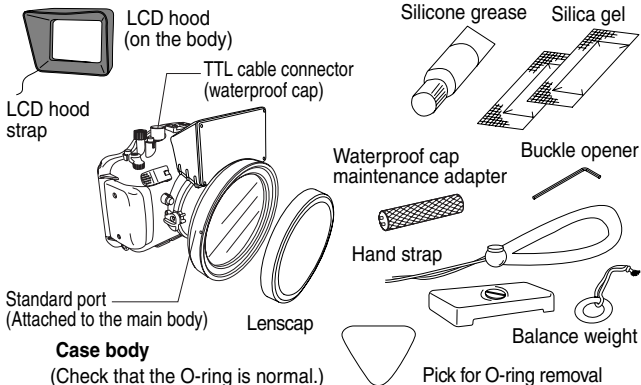

Instruction manual
(this manual)



Warranty card



Diver's insurance guide



Information disc



Names of the parts

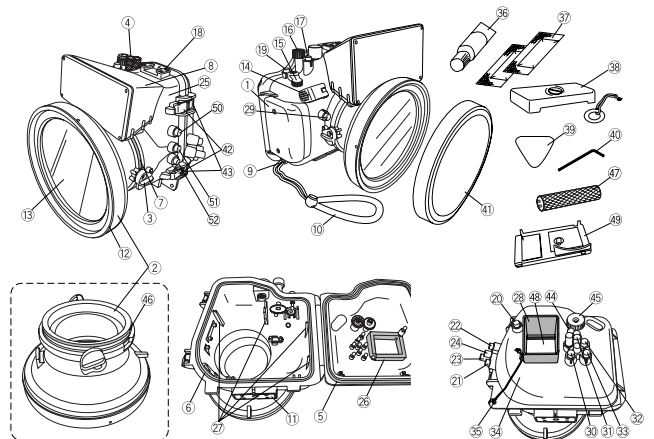

- | | | |
|---|---|--|
| ① Palm grip | * ⑱ Custom button | ③⑤ LCD hood strap |
| ② Standard port (PPO-04) | * ⑳ Self-timer/Remote control/ Erase button | ③⑥ Grease for O-rings (White-cap tube) |
| ③ Port lock buckles | * ㉑ Metering/Print reservation button | ③⑦ Silica gel |
| ④ TTL cable connector (waterproof cap) | * ㉒ AF/Macro/MF button | ③⑧ Balance weight |
| ⑤ O-ring (POL-023A) | * ㉓ Exposure compensation/Data display button | ③⑨ Pick for removing O-rings |
| ⑥ O-ring (POL-023B) | * ㉔ Flash mode/Rotation playback button | ④⑩ Buckle opener |
| ⑦ O-ring (POL-023C) | ②⑤ Front lid | ④① Lens cap |
| ⑧ Diffuser plate and diffuser plate * cover | ②⑥ LCD inner hood | ④② Buckle open/close lever |
| ⑨ Carrying strap ring | ②⑦ Mounting guide rails | ④③ Buckle hook |
| ⑩ Carrying strap | ②⑧ LCD hood | * ④④ Quick View button |
| ⑪ Tripod socket | * ②⑨ AEL button | * ④⑤ Control dial knob |
| ⑫ Lens ring | * ③⑩ LCD monitor button | ④⑥ Standard port O-ring (POL-104) |
| ⑬ Lend window | * ③① OK/Menu button | ④⑦ Waterproof cap maintenance adapter |
| * ⑭ Shutter release lever | * ③② Cross button | ④⑧ LCD monitor window |
| * ⑮ Zoom lever | * ③③ Card select button | ④⑨ Camera mount |
| * ⑯ Mode dial knob | ③④ Rear lid | * ⑤⑩ Flash button |
| * ⑰ Power switch button | | * ⑤① White balance button |
| ⑱ Accessory mount | | * ⑤② Picture quality mode button |

Note : The Case operation parts marked by * corresponds to the operation parts of the digital camera. When the operation parts of the Case are operated, the corresponding functions of the digital camera will operate. For details of the functions, refer to the instruction manual for the digital camera.

Install the strap.

Install the strap on the Case body.

Installation explanation

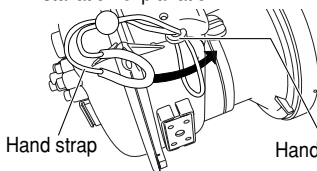

Finished installation

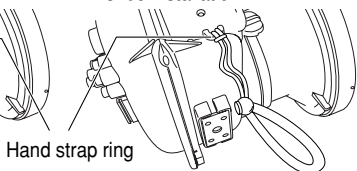

CAUTION : Please install the strap correctly as shown above. OLYMPUS CORPORATION shall bear no responsibility for damage etc. caused by dropping the Case because of incorrect installation of the strap.

Master the basic operation.

Please master the basic operation of the Case before taking pictures.

Holding the Case

Hold the Case securely with both hands, keep your elbows close to your body, and hold the Case so that you can confirm the picture on the LCD monitor of the digital camera through the LCD monitor window of the Case.

Good example

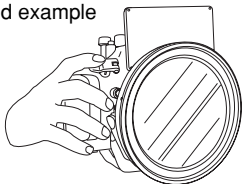

Bad example

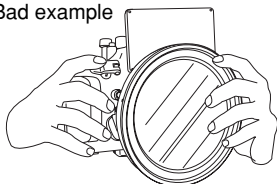

CAUTION : • Do not exert excessive force onto the lens window or the lens ring.
• Take care not to put your fingers etc. over the lens window and the flash diffuser.

Note: • Check your image on the LCD monitor. The viewfinder cannot be used to check the image.

How to Press the Shutter

When pressing the shutter lever, press it gently, so that there will be no movement of the camera.

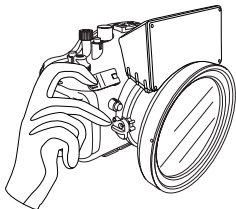

Note: • For more detailed information on operating the shutter release, please consult the digital camera's instruction manual.

How to Use the Mode Dial

The case is equipped with a mode dial knob that fits on the camera's mode dial and functions the same way. After inserting the digital camera into the case, make sure that the mode dial knob is operable before taking any image.

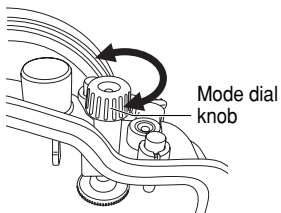

Advice • Please confirm that the mode dial knob has been set securely to the mode dial of the digital camera. If the mode of the digital camera does not change when the mode dial knob is operated, turn the dial while pushing it lightly.

How to Use the Zoom Lever

Zoom operation is possible by operating the zoom lever of this Case corresponding to the zoom lever of the digital camera in the Case.

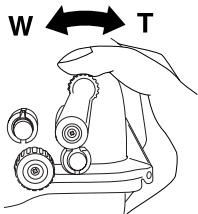

Setting the Zoom Lever

When loading the digital camera in the Case, fit the projecting part of the zoom lever of the camera into the recessed part of the zoom lever of the Case.

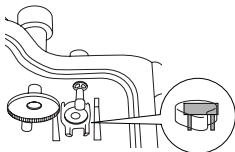

- Advice**
- When loading the camera, confirm that the projecting part of the zoom lever of the camera is properly set to the recessed part of the zoom lever of the Case.
 - When the setting is insufficient, the loading of the camera becomes imperfect and it may not be possible to seal the Case or zooming may not function. Insufficient sealing will cause water leakage.

Power Switch Button Operation Method

Press the power switch button to switch on the camera power supply.

When the power switch button is pressed again, the camera power supply is switched off.

Power switch
button

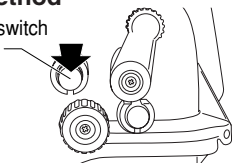

- CAUTION** : • When the digital camera has not been used for about 3 minutes while in the shooting mode, it enters the sleep mode (standby status). In the sleep mode, the lens returns to the wide-angle end and no camera operation is possible. To cancel sleep mode (and return to operation status), press the shutter button or any other button. For details, refer to your digital camera's instruction manual.

Popping up the Flash

Press the flash button on the case to pop up the camera's flash.

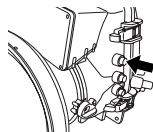

- CAUTION** : • Once the flash is up, it cannot be retracted as long as the camera is in the case. Remove the camera from the case to retract the flash.

Removing/attaching the standard port



The standard port attached to the case should be removed when the Wide Port for PT-023 (optional PPO-05) is used.

The standard port can be removed and attached as follows.

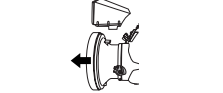
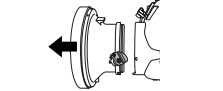
Removing

1 First wipe any moisture off the case, and then slowly turn the two buckles on either side of the standard port in the opening direction (from down to up, in the direction of the arrows as shown in the figure on the right).	
2 When the two buckles have been turned by about 110 degrees from down to up, the standard port begins to separate from the case. (At this time, the diffusion plate also separates from the case. Be careful not to drop the plate.)	
3 Continue turning the buckles slowly until the standard port separates completely from the case. (At this time, the diffusion plate also separates from the case.)	

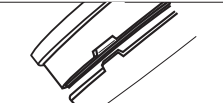
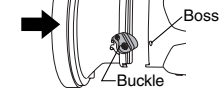
Attaching

1 After aligning the notch on the standard port's case mount with the protrusion on the case's port mount, fit the standard port into the case. (If you are going to mount the diffusion plate at this time, see "Removing/attaching the diffusion plate" on next page.	
2 Mount the standard port on the case so that the bosses on the case fit into the left and right buckles.	
3 Turn the two buckles from up to down until they stop to secure the standard port.	

⚠ CAUTION : • If the standard port is attached improperly to the case, water penetration may result. Also make sure that the buckles on the left and right of the standard port are clamped firmly.

* Refer to the Wide Port for PT-023's (optional PPO-05) instruction manual for detailed instructions on using it.

Detaching/attaching the diffusion plate

The diffusion plate on the case is detachable. Remove the diffusion plate when using the optional PPO-05 Wide Port or when the diffusion plate is not necessary. To attach the diffusion plate, follow the procedure below.

Detaching

1	First make sure the case is completely dry. While gently holding the diffusion plate and standard port, slowly turn the two buckles on either side of the standard port by about 110° in the opening direction (from down to up, in the directions of the arrows).	
2	Keep turning the buckles gently to separate the diffusion plate and standard port completely from the case.	
3	Pull the diffusion plate from the standard port in the direction of the arrow to separate them.	

Attaching

1	Align the diffusion plate's rear window (B) with the case's diffusion guides (A) .	
2	While fitting the diffusion plate mount (C) on the top panel of the standard port into the port mount hole (D) on the bottom of the diffusion plate, insert the standard port into the case.	
3	Make sure that the diffusion plate is wedged between the front of the case and the top of the standard port. Then turn the buckles on either side of the standard port in the direction of the arrows to secure them. (For details on how to mount the standard port, see "Detaching/attaching the standard port" on the previous page.)	

⚠ CAUTION : • The diffusion plate cannot be used when the PPO-05 is mounted.

Removing the TTL cable connector cap

TTL flash shooting is possible by uncapping the TTL cable connector on this case (PT-023) and connecting the FL-20 flash case (optional PFL-01) as described in the following procedure.

TTL flash shooting by combining this case (PT-022) and the case for FL-20 flash (optional PFL-01):

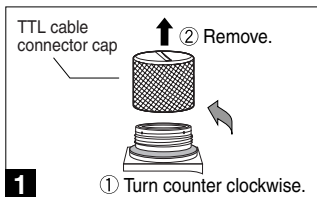

- 1 Remove the TTL cable connector cap from this case.

* The PFL-01 can be used only with the C-770 Ultra Zoom.

- 2 Connect the underwater TTL cable connector, provided with the PFL-01, to the TTL cable connector on this case.

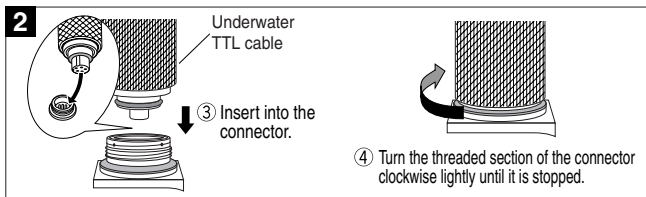

---- How to attach the TTL cable connector cap to the case ----

Make sure there is no foreign matter attached to the O-rings inside the cap and on the TTL cable connector. To secure the cap, gently turn it clockwise until it stops.

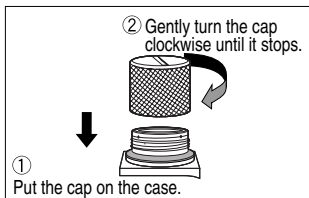
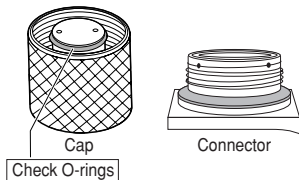





■ ■ ■

⚠ CAUTION : • If the TTL cable connector cap is loose, water penetration may result. Be sure to gently turn the cap until it stops to make sure it is firmly secured. Do not turn or tighten the TTL cable too hard. If it is too tight, it may be difficult to loosen and remove it.

* Refer to the optional PFL-01's instruction manual for detailed instructions on using the TTL cable and hot shoe cable.

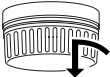
Removing the hot shoe cable cap

To perform TTL flash shooting when this case is used, connect the hot shoe cable provided with the optional PFL-01 between the connector on this case and the C-8080 Wide Zoom's hot shoe.

1	Turn the hot shoe cable connector cap inside the case counterclockwise to remove it.	
2	Insert the connector of the hot shoe cable into the case's connector and turn the connector screws all the way clockwise to connect them firmly.	
3	Insert the cable's hot shoe into the C-8080 Wide Zoom's hot shoe.	
4	When not using the hot shoe cable, attach the hot shoe cable cap to the hot shoe cable connector inside the case and turn the cap all the way clockwise to attach it firmly.	

⚠ CAUTION : • Be sure to remove the camera from the case when inserting the connector of the hot shoe cable into the case's connector.

Cleaning the TTL connector

If the threaded sections of the TTL cable and TTL cable connector stick to each other, the cable may disconnect from the connector. To prevent this, apply O-ring silicon grease (provided with this case) to the threaded sections.

For details, see the maintenance description on page 33 of this manual.

⚠ CAUTION : • If you cannot disconnect the TTL cable, do not use force to disconnect it. Contact Olympus for support.

2. Advance Check of the Case

Advance test before use

This Case has been the subject of thorough quality control for the parts during the manufacturing process and thorough function inspections during the assembly. In addition, a water pressure test is performed with a water pressure tester for all products to confirm that the performance conforms to the specifications. However, depending on the carrying and storage conditions, the maintenance status, etc., the waterproof function may be damaged.

Before diving, always perform the following advance test and the water leakage test after installation of the camera.

Making sure the case is waterproof

Check the parts that ensure the case is waterproof.

1. Make sure that the O-ring between the front and rear lids of the case is attached firmly and the buckle is tightly secured.
2. Make sure that the O-rings between the case and standard port are attached firmly and that the buckles are tightly secured.
3. Make sure that the O-ring on the TTL cable connector cap is attached firmly and that the cap is fitted tightly to the connector.

Advance Test

1. Before installing the digital camera in the Case, immerse the empty Case to the intended water depth to confirm that there is no water leakage.
2. Main causes of water leakage are as follows.
 - The O-ring has not been installed.
 - A part of the O-ring or the entire O-ring is outside the specified groove.
 - O-ring damage, cracks, deterioration or deformation.
 - Sand, fibers, hair or other foreign matter sticking to the O-ring, the O-ring groove or the O-ring contact surface.
 - Damage to the O-ring groove or the O-ring contact surface.
 - When closing the Case, check for catching of the hand strap and silica gel after the above causes have been eliminated.

⚠ CAUTION : • The most suitable method for checking water leakage is to immerse the Case to the intended water depth. When this is difficult, water leakage also can be checked at a shallow depth with no water pressure. Do not feel that this is troublesome, but perform this test.

• If the advance test should show water leakage with normal handling, stop using the Case and contact your dealer or an Olympus service station (listed on the rear page of this instruction manual).

3. Install the digital camera.

Check the digital camera.

Check the digital camera before loading it in the Case.

Battery Confirmation

Since the LCD monitor is used for picture confirmation while taking pictures under water, the battery life becomes short.

Confirm that the remaining battery capacity is sufficient.

Note: • To make sure you aren't prevented from shooting because the battery runs out, it is recommended that you load a fully-charged battery before every diving session.

Confirmation of the Remaining Number of Pictures to be Taken

Confirm that the image storage has a sufficient remaining number of pictures to be taken.

Removing the carrying strap and lens cap from the digital camera

If the digital camera has a carrying strap and lens cap attached, be sure to remove them before inserting the digital camera into the case.

⚠ CAUTION : • If the digital camera is inserted into the case without removing the carrying strap and lens cap, the case cannot be closed properly and water penetration may result.
• Be careful when removing the carrying strap and lens cap from the digital camera. Olympus will not assume any liability for any damage that may result from dropping the camera.

Removing the filter from the digital camera

If the digital camera has a lens filter attached, be sure to remove it before inserting the camera into the case.

⚠ CAUTION : • The digital camera cannot be inserted in the case if a filter is attached to the camera lens. Always be sure to remove the lens filter.

Setting the camera mount on the digital camera

Attach the provided camera mount to the tripod socket of the camera.

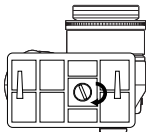

CAUTION: • Attach the camera mount in the proper direction as shown in the above figure.

Loading in the Case

Which digital cameras can be loaded?

This product (PT-023) is exclusively used for the CAMEDIA C-8080 Wide Zoom.

Check the operation of the camera.

Confirm the operation according to the instruction manual for the digital camera.

Open the Case.

Insert the buckle opener of the accessory into the buckle opening lever as shown in the figure (in direction ①). Pull the buckle opener slowly (in direction ②). When not using the buckle opener, hold the buckle opening lever with your thumb and index finger from the side and pull it up slowly.

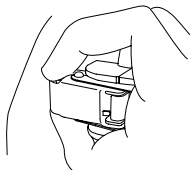
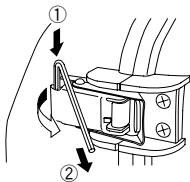

Lifting the mode dial knob

Pull up the mode dial of the case until it stops, so that it does not interfere with the mode dial of the digital camera.

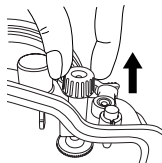

Load the digital camera.

Push the digital camera attached to the camera mount so that the mount's guides slide along the mounting guide rails on the front lid of the case. Push it as far as it goes. Quietly load the digital camera into the Case, taking care that the projecting part of the zoom lever of the digital camera properly fits into the recessed part of the zoom lever of the Case.

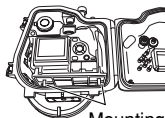

Mounting guide rails



Guides

- CAUTION:**
- Be sure to store the camera flash before loading the camera in this case.
 - After closing the case, make sure that the camera mount is properly attached to the front lid and rear lid.

Fitting the mode dial knob

After the digital camera has been loaded, push down the mode dial of the case from the upper surface of the case and set it so that the lower part of the mode dial of the case on the inside of the case fits properly onto the upper part of the mode dial of the digital camera.

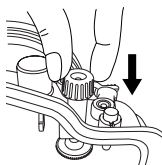

- Advice**
- After properly fitting the case's mode dial knob, turn the knob to make sure that the camera's mode dial switches before closing the case tightly.

Insertion of silica gel

Before sealing the Case, insert the accessory silica gel bag (for prevention of fogging) between the bottom of the camera and the Case. Insert the bag with the glued longer side to the inside.

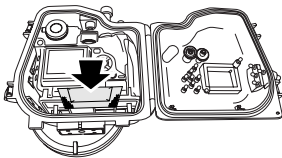

Pay attention to the orientation.

- CAUTION:**
- Insert the silica gel all the way at the specified location and with the specified orientation. When the orientation is not correct, the silica gel bag will be caught when the Case is sealed and water leakage will be caused.
 - Attempting to seal the Case with the bag inserted only part of the way will cause the silica gel bag to get caught by the O-ring and water leakage will occur.
 - Once silica gel has been used, the moisture absorption performance will be impaired. Always exchange the silica gel when the Case is opened and closed.

Check the loading status.

Always perform the following final checks before sealing the Case.

- Has the camera been inserted properly so that the zoom lever works?
- Has the silica gel bag been placed in the correct position and in the proper way?
- Are both the O-rings and the contact surfaces of the front lid free of dirt and other foreign matter?
- Are the O-rings correctly positioned in the groove of the front and rear lids?
- Is the lens port attached properly and are the buckles locked correctly?
- the TTL cable connector cap attached tightly?

Seal the Case.

When the rear lid is closed (quietly, so that the O-ring will not come out of the groove), the buckles are engaged with the edge of the rear lid, and the buckle lock levers are pushed down in arrow direction, the Case will be sealed airtight.

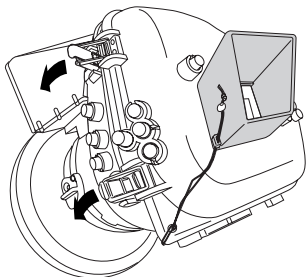

- CAUTION:**
- Seal the Case by turning both buckle lock levers down in arrow direction. When one of the buckles is left open, the Case will not be sealed and water leakage will be caused.

Install the special balance weight.

Install the special balance weight to the tripod mounting thread at the bottom of the Case. Install the balance weight securely by tightening the accessory screw of the balance weight.

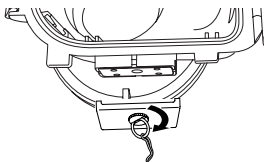

Installation and Removal of the LCD Hood

Installation

Strongly push the mounting projections of the LCD hood as shown in the figure into the guides above and below the LCD monitor window.

Removal

Remove the mounting projections of the LCD hood from the guides above and below the LCD monitor window by widening the LCD hood.

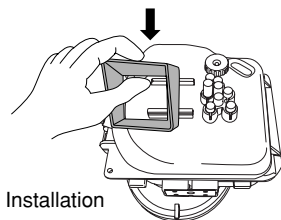
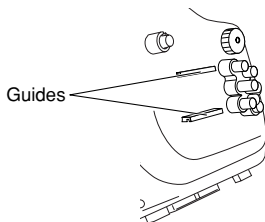

Installation

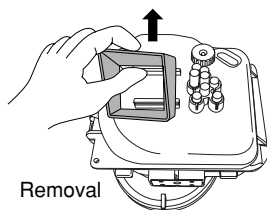

Removal

Mounting and Removing the Lens Cap

Fit the lens cap onto the lens ring as shown in the figure. Be sure to remove the lens cap before shooting.

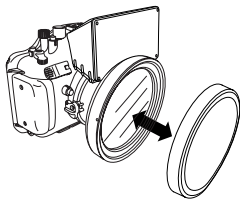

Perform the final checks.

Visual Inspection

After closing the case tightly, check the seal between the front and rear lids and the connection between the port and case to make sure the O-rings are not twisted, that they sit properly in the grooves, and that no foreign matter has been caught between the two parts.

⚠ CAUTION : • Hairs, fibers, and other narrow items are not very apparent, but they may cause entry of water, so that special attention is required.

Setting the camera power to ON and OFF

Move the power switch button and confirm that the camera can be turned ON and OFF.









Try to move the mode dial.

After sealing, turn the mode dial knob and confirm that the mode dial of the camera is switched.

⚠ CAUTION : • After inserting the camera into the case, confirm that the mode dial moves. If it does not move, oil or grease may have gotten on the mode dial. Wipe it clean.

Final Test

The final test after loading the camera is explained below. This is the only way to eliminate worry about possible entry of water! Always perform this test. It can be performed easily in a water tank or a bathtub. The required time is about five minutes.

	Simple water immersion test	Explanatory image	Hints
1	Place the Case slowly into the water.		As the Case is transparent, waterdrops entering into it can be confirmed easily.
2	At first, immerse the Case for only three seconds.		In case of trouble with the O-ring, three seconds are enough for water to enter. Are there air bubbles coming out between the lids? Please check carefully.
3	Check that no water has entered into the Case.		Remove the Case from the water and check that no water has accumulated at the bottom of the Case. Is there any water trickling down?
4	Next, immerse the Case for 30 seconds.		Check carefully for air bubbles! Do not perform any operation yet, but just observe.
5	Check that no water has entered.		Remove the Case from the water and check that no water has accumulated at the bottom of the Case. Perform very careful confirmation.
6	Next, check by immersing for three minutes.		Check carefully for air bubbles! Try operation of the buttons used frequently. Check carefully for air bubbles! If there is still no entry of water, everything is OK!
7	This is the final check. Has the silica gel become moist?		This is very important! Has the silica gel become moist? Please check carefully! As the inside can be seen, the inspection for entry of water also can be made securely!
8	Now everything is all right. Do not forget the balance weight.		Now everything is all right! Have a nice dive! Did you remember to attach the balance weight?

4. Taking Pictures Under Water

How to Use the Hand Strap

Pass your hand through the accessory hand strap and adjust the length with the stop button.

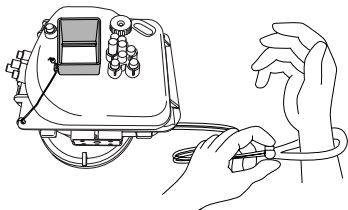

Take pictures carefully.

Confirm the picture on the LCD monitor.

This Case uses the LCD monitor to confirm the picture. The viewfinder cannot be used.

Quietly press the shutter lever.

When pressing the shutter lever, hold the Case securely with both hands and operate the lever quietly to prevent camera shake.

Caution when using the flash

When taking macro shots with a wide-angle setting, the flash may provide uneven and/or insufficient illumination.

Flash reaching range (Land shooting)	Wide angle :	Approx. 0.8 m to 5.8 m
	Tele :	Approx. 0.2 m to 4.0 m

During underwater shooting, shooting conditions (water clarity, suspended matter, etc.) can have a significant effect on the range of the flash.

Always check your pictures on the LCD monitor after shooting.

⚠ CAUTION : • When the Wide Port for PT-023 (optional PPO-05) is used, the light from the camera's built-in flash will not be sufficient for shooting. In this case, use an external flash (for example, the FL-20 Electronic Flash and PFL-01 case).

5. Handling After Shooting

Wipe off any waterdrop.

After underwater shooting, remove any drops of water from the case. Use pressurized air or a soft, lint-free cloth to carefully wipe away any moisture from the hinge between the front and rear lids, the shutter release lever, the handgrip and the buckles.

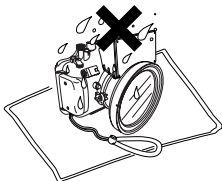

⚠ CAUTION:

- Water left between the front and rear lids or between the case and port can get inside the case once it is opened or the port is detached. Please dry these areas carefully.
- When opening the case or removing the port, make sure no water from outside (e.g. drops from your hair or the diving suit) gets inside of the case and/or on the camera!
- Before opening the case or removing the port, ensure that your hands or gloves are completely clean (free of sand, loose fibers, etc.).
- Never open the case or remove the port in areas where water could splash or spray or where sand or dust could be blown in the air. When this cannot be avoided, for example if the battery or memory card needs to be changed, the case and camera should be protected from the wind or spray with a plastic sheet or similar object.)
- Never touch the digital camera and/or battery you're your hands are wet with sea water.

Note:

- Moisten a cloth or towel with tap water and keep it in a plastic bag. Use this to wipe the salt water or crystals from your hands before you touch the camera.

Take out the digital camera.

Open the case carefully, pull up the mode dial from the upper surface of the case to disengage it from the mode lever of the camera, and then remove the digital camera from the case.

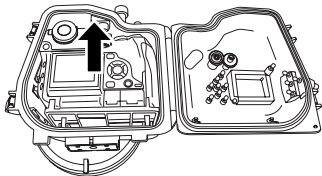

- CAUTION :**
- After opening the case, always put it down with the O-ring side face-up. Otherwise, dirt or other foreign matter could attach itself to the O-rings and/or the contact surfaces, allowing water to penetrate the case during the next dive.
 - For information on storing images, refer to the digital camera's instruction manual.
 - When removing the digital camera from the case, it is very important you make sure the case's mode dial knob is not still attached to the camera's mode dial. Never use force to remove the digital camera. This could damage the camera or the case.

Wash the Case with pure water.

After use, seal the Case again after taking out the camera and wash it sufficiently in pure water as soon as possible. After use in sea water, it is effective to immerse it for a fixed time in pure water to remove any salt.

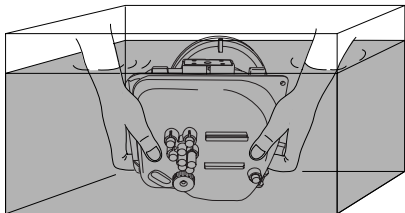

- ⚠ CAUTION :**
- Water leakage may be caused when a high water pressure is applied locally. Before washing the Case with water, remove the digital camera from it.
 - Operate the shutter lever and various buttons of this product in pure water to remove salt adhering to the shaft. Do not disassemble for cleaning.
 - Drying the Case with adhering salt may impair the function. Always wash off any salt after use.

Dry the Case.

After washing with pure water, use a soft cloth without any salt on it and not causing any fibers to wipe off any waterdrop and dry the Case completely at a well ventilated location in the shade.

In particular, to prevent the threaded sections of the TTL cable and TTL cable connector from sticking, be sure to clean the threaded sections with a cotton swab and apply a thin, uniform layer of O-ring silicon grease (provided with this case).

- ⚠ CAUTION :**
- Do not use hot air from a hair drier or the like for drying and do not expose the Case to direct sunlight, as this may accelerate deterioration and deformation of the Case and deterioration of the O-ring, leading to leakage of water.
- When wiping the Case, take care not to cause scratches.

6. Maintaining the Waterproof Function

Remove the O-ring.

Open the Case and remove the O-ring from the Case.

Removal of the O-ring

- ① Insert the O-ring removal pick between the O-ring and the wall of the O-ring groove.
- ② Move the tip of the inserted pick under the O-ring. (Take care not to damage the O-ring groove with the tip of the pick.)
- ③ Hold the O-ring with your fingertips after it has come out of the groove and remove it from the Case.

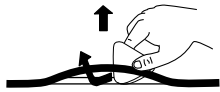

Remove any sand, dirt, etc.

After visually checking that dirt has been removed from the O-ring, checking for attached sand and other foreign matter, as well as for damage and cracks can be done by squeezing the entire circumference of the O-ring lightly with your fingertips.

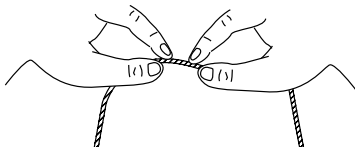

Using a clean cloth free of fibers, dirt, etc., a piece of lint-free tissue paper or a soft toothbrush, remove any foreign matter attached to the grooves of the O-rings. Also remove sand and dirt particles attached to the O-ring contact surfaces on the case.

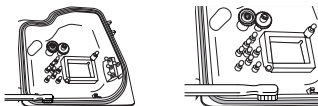





- ⚠ CAUTION :**
- When a mechanical pencil or a similar other sharp object is used to remove the O-ring or to clean the inside of the O-ring groove, the Case and the O-ring may be damaged and water leakage may be caused.
 - When the O-ring is checked with the fingertips, take care not to stretch the O-ring.
 - Never use alcohol, thinner, benzene or similar solvents or chemicals detergents to clean the O-ring. When such chemicals are used, it is likely that the O-ring will be damaged or that its deterioration will be accelerated.

Install the O-ring.

Confirm that no foreign matter is attached, apply a thin coat of the accessory grease to the O-ring, and fit the O-ring into the groove. At this time, confirm that the O-ring does not stick out from the groove.

How to Apply Grease to the O-ring

1	Apply the exclusive lubricant to each O-ring.		Make sure that your fingers and the O-ring are free of dirt, and squeeze about 5 mm of lubricant onto a finger. (5 mm is the most appropriate amount.)
2	Spread the lubricant all over the O-ring.		Surround the lubricant with three fingers and spread it over the ring. Be careful not to use excessive force as this may stretch the O-ring.
3	Check that the O-ring is free of scratch or unevenness.		After spreading the lubricant, check visually and by touch that the O-ring is not scratched and that its surface is flat. If it is damaged in any way, replace it with a brand-new O-ring.
4	Apply lubricant on the O-ring contact surface.		Use the lubricant remaining on the fingers to clean and lubricate the case's contact surface.

- CAUTION:**
- Always perform maintenance of the waterproof function even when the Case has been opened to exchange the battery or the image storage during shooting. Neglecting this maintenance may become the cause of water leakage.
 - When the Case is not to be used for a long time, remove the O-ring from the groove to prevent deformation of the O-ring, apply a thin coat of silicone grease, and store it in a clean plastic bag or the like.
 - When drying is done with salt attached, it is likely that a function impairment will be caused. After use, always wash off any salt.

Maintenance of the threaded sections on the TTL cable and TTL cable connector

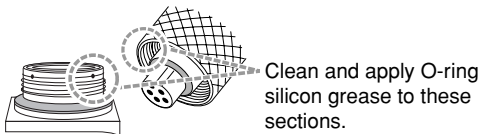

If the threaded sections used to connect the TTL cable to the TTL cable connector are not maintained properly, salt and other seawater residue may adhere the TTL cable and prevent it from being disconnected. After use in seawater, clean off any salt, sand, or other residue as soon as possible, then dry the equipment thoroughly. Clean the threaded sections with a cotton swab and apply a thin, uniform layer of O-ring silicon grease (provided with this case).

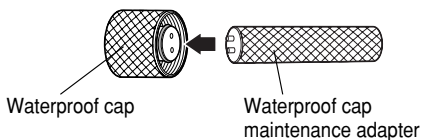

Maintenance of the TTL Connector Cap

After removing the TTL connector cap from the waterproof cap, be sure to clean and grease the O-ring. Use the waterproof cap maintenance adapter to remove the O-ring unit from the waterproof cap.

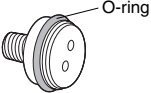

1	Insert the adapter by aligning its pin with the hole on the cap.	
2	Turn the adapter counterclockwise to remove the O-ring unit.	
3	After removing the O-ring attached to the O-ring unit, clean the O-ring groove and apply silicon grease to the O-ring. Then, re-attach the O-ring to the O-ring unit.	

※ Reverse the removal procedure to re-attach the O-ring unit to the waterproof cap.

Replace consumable products.

- The O-ring is a consumable product. Independent of the number of times the Case is used, it is recommended that the O-ring should be replaced by a new one at least once a year.
- Deterioration of the O-ring is accelerated by the use conditions and the storage conditions. Replace the O-ring even before a year has passed if it shows signs of damage, cracking or loss of elasticity.

Note: • Please use original Olympus products for the silicone O-ring grease, the silica gel, and the O-ring. These consumable products also can be purchased at an Olympus service station.

7. Appendix

Q & A on the use of the PT-023

Q1 : Which digital cameras can be used with this case?

A1 : This case is designed exclusively for use with the CAMEDIA C-8080 Wide Zoom.

Q2 : What points should be observed when inserting the digital camera into the case?

A2 : When inserting the digital camera you should pay special attention to the following points:

- (1) Check that the digital camera's battery is fully charged.
This is important because in underwater shooting you can only use the LCD monitor for framing shots. This uses much more battery power than the optical viewfinder.
- (2) Check the number of remaining images that can fit on the memory card.
Please use a card with as much free storage space as possible so you won't have open and close the case to replace the card.
- (3) Remove the carrying strap and lens cap from the digital camera.
If the carrying strap and lens cap are not removed from the digital camera, they could catch between the two lids of the case and prevent it from closing properly. This could lead to water penetration.
- (4) Before closing the case, check that the O-rings sit correctly in the groove.
- (5) Make sure that the buckles used for connection of the case and port and TTL connector cap are closed firmly.
- (6) Make sure that the O-rings and the case's contact surfaces are free of foreign matter and dirt.
- (7) Place the silica gel bag in the case to avoid fogging. Only use Olympus silica gel.
- (8) When loading the digital camera into this case, first attach the camera mount to the camera and make sure that the projecting section of the camera's zoom lever fits into the zoom lever notch on the case. Load the camera carefully, close the rear lid on the case and lock the buckle.
- (9) Install the special balance weight on the tripod mount thread.

Q3 : What cautions must be observed when using and storing the Case?

A3 : Pay special attention to the following items.

- (1) When the O-ring contact surface is pressed strongly from the outside of the Case, or when the Case is twisted, the waterproof function may be impaired and water leakage may be caused.
- (2) When the Case is used, left or stored at the following locations, defective operation or trouble may be caused. Always avoid such locations.

- (a) Places where the Case can reach high temperatures under direct sunlight or in a car, places with extremely low temperatures, and places with extreme temperature variations
 - (b) Places with open fire
 - (c) Places with volatile substances
 - (d) Places with vibrations
- (3) In case of the following handling with a camera loaded into the Case, trouble or breakage may be caused for the Case and/or the loaded camera. Always avoid such handling.
- (a) Hitting other objects
 - (b) Dropping
 - (c) Placing heavy objects on top of the Case
- (4) When the Case is not used for a long time, trouble from formation of mold etc. may be caused. Before use, confirm the operation of all operation parts and perform the advance test and the final test.

Q4 : What cautions must be observed when opening and closing the Case?

A4 : Pay special attention to the following items.

- (1) Do not open and close the Case at locations with water spray or sand spray.
- (2) Wipe off all waterdrops from the gap between the front lid and the rear lid and around projections and recesses such as the buckles. When this is not done, entry of waterdrops into the Case is to be feared at the time of opening and closing.
- (3) When opening the Case, take care that no water will drip from your hair or body into the Case or onto the camera.
- (4) When the case is open, examine the O-rings and the O-ring contact surfaces on the front lid for foreign matter such as hair, fiber, and grains of sand. Remove these if present. Also examine the O-rings used for connection of the case and port.
- (5) Do not touch the camera or the image storage with your hands to which sea water is sticking.
- (6) If you should detect waterdrops or other signs of water leakage while shooting, immediately end the dive, perform the water leakage test again, and confirm that there is no leakage. If the camera is wet, wipe off any moisture and check the operation.

Q5 : How should the Case be handled after use?

A5 : After use, take out the camera as soon as possible and wash the Case with pure water. In case of use in the ocean, it is effective to immerse the Case for a certain time in pure water to remove any salt. Operate the buttons and levers under water to turn the shafts and wash off any salt. After washing, use a dry cloth without any salt on it to wipe off any

moisture and dry the Case in the shade. Do not use hot air from a hair drier or the like and do not dry the Case under direct sunlight. Exposure to high temperatures or direct sunlight may cause deformation, discoloration or breakage of the Case and deterioration of the O-ring. Wipe the inside of the Case with a soft cloth not causing any fibers. Remove the O-ring, wipe off any salt, sand, dust, etc., and also clean the O-ring groove and the O-ring contact surface in the same way and then dry them. When an object with a sharp tip is used to remove the O-ring from the groove, the O-ring may be damaged and water leakage may be caused. Always use the accessory pick for O-ring removal. Be sure to clean the threaded sections on the TTL cable and TTL cable connector after drying and apply a thin, uniform layer of O-ring silicon grease (provided with this case).

Q6 : How should I take pictures under water?

A6 : Please observe the following items for shooting under water.

- (1) Fix the Case with the accessory hand strap to your wrist.
- (2) When you place a finger onto the lens window, the finger will appear in the photo. Pay attention to the position of your fingers when holding the Case.
- (3) When pressing the shutter lever, hold the Case securely with both hands and operate the lever quietly to prevent camera shake.
- (4) Look through the LCD monitor window on the rear of the Case to confirm the picture and then press the shutter lever. Please note that the viewfinder cannot be used. When the LCD monitor is used, the battery is exhausted earlier. In order to avoid losing shutter chances due to an exhausted battery, please always replace a battery with a fully charged battery before each dive.

Q7 : How can I check for water leakage?

A7 : For confirmation, perform the advance test and the final test after loading the camera. The advance test with immersing the Case without the camera to the intended use depth to check for water leakage is the most accurate test, but when this is difficult, it is safer to perform this test even at a depth of 1 m or in a bathtub. The final test also can be performed in a bathtub or a bucket.

Q8 : What are the causes for entry of water?

A8 : The main causes for the entry of water are shown below. Please check them most carefully.

- (1) Forgetting to install the O-ring
- (2) The O-ring is partly or completely outside the groove.

- (3) Damage, deterioration, or deformation of the O-ring
- (4) Sand, fibers, hair or other foreign matter on the O-ring
- (5) When foreign matter (sand, fiber, hair, etc.) is stuck to the O-ring grooves or O-ring contact surfaces.
- (6) Catching of the strap, the bag of silica gel, etc. at the time of sealing the Case.
- (7) Throwing the Case from a boat into the water, jumping with the Case into the water, or other sudden application of strong forces onto the Case. When entering the water, hand the Case over quietly or avoid impacts in other ways.

Q9: What are the important points for O-ring maintenance?

A9: Please observe the following items.

- (1) Never use alcohol, thinner, benzene or similar organic solvents or chemical detergents to clean the O-ring. When such chemicals are used, it is to be feared that the O-ring will be damaged or that its deterioration will be accelerated.
- (2) Use the original Olympus silicone O-ring grease (white cap). The grease attached to Cases up to PT-008 (red cap) and the grease of other companies are not suitable for this silicone O-ring, and use of such grease may cause deterioration of the surface and impairment of the waterproof function.
- (3) In order to avoid deformation of the O-ring when the Case is not used for a long time, remove the O-ring from the Case, apply a thin coat of the special grease, and store the O-ring in a clean plastic bag. For reuse, confirm that the O-ring is free of damage and cracks, that it has sufficient elasticity, that the surface is free of stickiness and other abnormalities, and use it after applying a thin coat of the special grease. Excessive application of grease does not improve the waterproof function or the permissible withstand pressure. However, it may facilitate attachment of sand, dirt, etc.
A thin, uniform coat produces the best result.
- (4) The O-ring is a consumable product. Replace it at least once a year.
- (5) Deterioration of the O-ring is accelerated by the use conditions and the storage conditions. Replace the O-ring immediately by a new one if it shows signs of damage, cracking or loss of elasticity.

Q10: What are the important points for Case maintenance?

A10: Please observe the following items.

- (1) Never use the following chemicals for cleaning, corrosion protection, defogging, repair or other purposes.
 - Never use alcohol, thinner, benzene or similar volatile organic solvents or chemical detergents to clean the Case. Pure water or lukewarm water

is sufficient for cleaning.

- Do not use anticorrosion agents on the metal parts. The metal parts are made of aluminum, brass or stainless steel. Cleaning with pure water is sufficient.
- Do not use commercial defogging agents. Always use the original Olympus defogging silica gel.
- Do not use adhesive for repairs or other purposes. When repair is required, please contact a service station of our company or your dealer.

Q11: Please tell me about repairs.

A11: Please contact a service station of our company or your dealer, if repair should be necessary. Do not try to repair, disassemble or modify the Case yourself. Repair, disassembly or modification by you or third parties not authorized by Olympus invalidates the guarantee.

Q12: What are the model numbers of the PT-023 accessories?

A12: The following accessories are being sold.

- (1) O-ring for the PT-023 case (POL-023A/¥1,050 with tax, POL-023B/¥1,050 with tax, POL-023C/¥1,050 with tax): Silicone rubber packing for sealing the case. Three types of O-rings are available. O-rings designed for models other than the PT-023 cannot be used.
- (2) O-rings for attaching the PPO-04 standard port to the PT-023 case (POL-104/¥1,050 with tax): Silicon rubber packing for sealing the connection between the PPO-04 and PT-023.
- (3) Silicone O-ring grease (PSOLG-1/¥840 with tax): This is a special grease for silicone O-ring maintenance.
- (4) Silica gel (SILCA-5/¥525 with tax): This is a desiccant used to prevent fogging of the glass parts of the Case. The quantity is five bags.
- (5) LCD hood (PFUD-04/¥1,050 with tax): This hood is installed on the LCD monitor window of the Case to make it easier to see the LCD monitor of the camera.
- (6) Balance weight for PT-023 (PWT-023/¥2,625 with tax): This is a weight intended to bring the Case close to neutral buoyancy in sea water. Under consideration of the environment, no lead is used.

h You can order in large computer shops and camera mass sale stores.

h Please contact your dealer or a service station of our company when replacement is required. Replacement will be made against payment.

Q13: How can I take good underwater photos?

A13: Olympus's ZUIKO CLUB online school website has a page describing underwater shooting techniques. You can access this page at the following link:

URL: <http://www.olympus-zuiko.com/school/index.html>

After-sale Service

- You will receive the Warranty card from your dealer. Please make sure that the dealer's name, the date of purchase, etc. have been entered. If they have not been entered, immediately ask your dealer to have them entered. Read the guarantee conditions carefully and keep the guarantee card at a safe location.
- Please contact your dealer or one of the service stations of OLYMPUS CORPORATION listed in this instruction manual for questions on aftersale service for this product or in case of defects. In case of a defect of this product, occurring within one year after the date of purchase and with handling according to this instruction manual, repair based on the conditions specified in the guarantee card is performed free of charge.
Payment is required for repairs after expiration of the guarantee period and for trouble caused by problematic handling by the customer even during the guarantee period.
- OLYMPUS CORPORATION keeps repair parts for this product for approximately five years after the end of production of the product. Accordingly, in principle repairs are accepted during this period. As repair may be possible even after this period, please contact your dealer or a service station in your neighborhood.
- Warranty is limited to and valid only in the region of intended distribution.
- Incidental damages from defects of this product (expenses required for diving, shooting expenses, loss of profit from photos, etc.) shall be excluded from the guarantee. In addition, transport expenses etc. related to repair shall be paid by the customer, independent of whether they are incurred during or after the guarantee period.

Specifications

Available models	Olympus digital camera CAMEDIA C-8080 Wide Zoom
Pressure resistance	Depth of up to 40 m
Main materials	Main body: Transparent polycarbonate Buckles: Stainless steel Grip/shutter release lever/zoom lever/mode dial knob/jog dial: Red polycarbonate Lens window: FL reinforced glass Lens ring: Aluminum Buttons: Nickel-plated brass O-rings/lens cap: Silicone rubber LCD hood: NBR rubber
Dimensions	Width 181 mm x height 188 mm x thickness 200 mm (projections not included)
Weight	1,475 g (LCD hood not included)

* We reserve the right to change the external appearance and the specifications without notice.

Diver's Insurance Guide

We recommend to subscribe to diver's insurance for water leakage. For details, refer to the enclosed Diver's Insurance Guide.