

## User Manual

***Thank you for choosing Philips.***

### ***Need help fast?***

*Read your Quick Start Guide and/or User Manual first for quick tips that make using your Philips product more enjoyable.*

***Register your product and get support at [www.philips.com/welcome](http://www.philips.com/welcome)***

*You can also visit the above website to download User Manual in Danish/Norwegian, Finnish and Swedish.*

*Du kan hente en brugerhåndbog på dansk/norsk og svensk fra ovenstående websted.*

*Du kan gå till ovanstående webbplats om du vill hämta användarhandboken på danska/norska och svenska.*

*Voit ladata edellä mainitusta osoitteesta myös käyttöoppaan norjan-, ruotsin- tai tanskankielisen version.*



# PHILIPS

## Important notes for users in the U.K.

### Mains plug

This apparatus is fitted with an approved 13 Amp plug. To change a fuse in this type of plug proceed as follows:

- 1 Remove fuse cover and fuse.
- 2 Fix new fuse which should be a BS1362 5 Amp, A.S.T.A. or BSI approved type.
- 3 Refit the fuse cover.

If the fitted plug is not suitable for your socket outlets, it should be cut off and an appropriate plug fitted in its place.

If the mains plug contains a fuse, this should have a value of 5 Amp. If a plug without a fuse is used, the fuse at the distribution board should not be greater than 5 Amp.

*Note: The severed plug must be disposed of to avoid a possible shock hazard should it be inserted into a 13 Amp socket elsewhere.*

### How to connect a plug

The wires in the mains lead are coloured with the following code: blue = neutral (N), brown = live (L).

- As these colours may not correspond with the colour markings identifying the terminals in your plug, proceed as follows:
  - Connect the blue wire to the terminal marked N or coloured black.
  - Connect the brown wire to the terminal marked L or coloured red.
  - Do not connect either wire to the earth terminal in the plug, marked E (or e) or coloured green (or green and yellow).

Before replacing the plug cover, make certain that the cord grip is clamped over the sheath of the lead - not simply over the two wires.

### Copyright in the U.K.

Recording and playback of material may require consent. See Copyright Act 1956 and The Performer's Protection Acts 1958 to 1972.

## Italia

### DICHIARAZIONE DI CONFORMITA'

Si dichiara che l'apparecchio BDP7100, Philips risponde alle prescrizioni dell'art. 2 comma 1 del D.M. 28 Agosto 1995 n. 548.

Fatto a Eindhoven

Philips Consumer Electronics  
Philips, Glaslaan 2  
5616 JB Eindhoven, The Netherlands

## Norge

Typeskilt finnes på apparatens underside.

**Observer: Nettbryteren er sekundert innkoplet. Den innebygde nettdelen er derfor ikke frakoplet nettet så lenge apparatet er tilsluttet nettkontakten.**

For å redusere faren for brann eller elektrisk støt, skal apparatet ikke utsettes for regn eller fuktighet.

## ATTENTION!

For Customer Use:

Read carefully the information located at the bottom or rear of your Blu-ray Disc Player and enter below the Serial No. Retain this information for future reference.

Model No. BDP7100

Serial No. \_\_\_\_\_

**DK**

**Advarsel: Usynlig laserstråling ved åbning når sikkerhedsafbrydere er ude af funktion. Undgå udsættelse for stråling.**

**Bemærk: Netafbryderen er sekundært indkoblet og afbryder ikke strømmen fra nettet. Den indbyggede netdel er derfor tilsluttet til lysnettet så længe netstikket sidder i stikkontakten.**

**S**

**Klass I laserparat**

**Varning! Om apparaten används på annat sätt än i denna bruksanvisning specificerats, kan användaren utsättas för osynlig laserstrålning, som överskrider gränsen för laserklass I.**

**Observera! Stömbrytaren är sekundärt kopplad och bryter inte strömmen från nätet. Den inbyggda nätdelen är därför ansluten till elnätet så länge stickproppen sitter i vägguttaget.**

**SF**

**Luokan I laserlaite**

**Varoitus! Laitteen käyttäminen muulla kuin tässä käyttöohjeessa mainitulla tavalla saattaa altistaa käyttäjän turvallisuusluokan I ylittävälle näkymättömälle lasersäteilylle.**

**Oikeus muutoksiin varataan. Laite ei saa olla alttiina tippu- ja roiskevedelle. Huom. Toiminnanvalitsin on kytketty toisiopuolelle, eikä se kytke laitetta irti sähköverkosta. Sisäänrakennettu verkko-osa on kytkettyinä sähköverkkoon aina silloin, kun pistoke on pistorasiassa.**

**CAUTION**

**VISIBLE AND INVISIBLE LASER RADIATION WHEN OPEN. AVOID EXPOSURE TO BEAM**

**ADVARSEL**

**SYNLIG OG USYNLIG LASERSTRÅLING VED ÅBNING UNDGÅ UDSÆTTELSE FOR STRÅLING**

**VARNING**

**SYNLIG OCH OSYNLIG LASERSTRÅLNING NÄR DENNA DEL ÄR ÖPPNAD BETRAKTA EJ STRÅLEN**

**VARO!**

**AVATTAESSA OLET ALTTIINA NÄKYVÄLLE JA NÄKYMÄTTÖMÄLLE LASER SÄTEILYLLE. ÄLÄ KATSO SÄTEESEEN**

**VORSICHT**

**SICHTBARE UND UNSICHTBARE LASERSTRAHLUNG WENN ABDECKUNG GEÖFFNET NICHT DEM STRAHL**

**AUSSETZEN**

**ATTENTION**

**RAYONNEMENT LASER VISIBLE ET INVISIBLE EN CAS D'OUVERTURE EXPOSITION DANGEREUSE AU FAISCEAU**

**This product complies with the radio interference requirements of the European Community.**



**This product complies with the requirements of the following directives and guidelines: 2006/95/EC + 2004/108/EC**

### Disposal of your old product



Your product is designed and manufactured with high quality materials and components, which can be recycled and reused.

When this crossed-out wheeled bin symbol is attached to a product it means the product is covered by the European Directive 2002/96/EC. Please inform yourself about the local separate collection system for electrical and electronic products.

Please act according to your local rules and do not dispose of your old products with your normal household waste. The correct disposal of your old product will help prevent potential negative consequences for the environment and human health.

Due to the inconsistency of disc formats provided by various disc manufacturers, your DVD system/ player/recorder may require a playability enhancement or upgrade. As DVD technology advances, these enhancements will become common and will be easy to complete. Go to [www.philips.com/support](http://www.philips.com/support) for software upgrade.

'CONSUMERS SHOULD NOTE THAT NOT ALL HIGH DEFINITION TELEVISION SETS ARE FULLY COMPATIBLE WITH THIS PRODUCT AND MAY CAUSE ARTIFACTS TO BE DISPLAYED IN THE PICTURE. IN CASE OF 525 OR 625 PROGRESSIVE SCAN PICTURE PROBLEMS, IT IS RECOMMENDED THAT THE USER SWITCH THE CONNECTION TO THE 'STANDARD DEFINITION' OUTPUT. IF THERE ARE QUESTIONS REGARDING OUR TV SET COMPATIBILITY WITH THIS MODEL 525p AND 625p DVD PLAYER, PLEASE CONTACT OUR CUSTOMER SERVICE CENTER.'

This product incorporates copyright protection technology that is protected by method claims of certain U.S. patents and other intellectual property rights owned by Macrovision Corporation and other rights owners. Use of this copyright protection technology must be authorized by Macrovision Corporation, and is intended for home and other limited viewing uses only unless otherwise authorized by Macrovision Corporation. Reserve engineering or disassembly is prohibited.



Manufactured under license from Dolby Laboratories. "Dolby" and the double-D symbol are trademarks of Dolby Laboratories.

English ----- 6

English



Manufactured under license under U.S. Patent #'s: 5,451,942; 5,956,674; 5,974,380; 5,978,762; 6,226,616; 6,487,535 & other U.S. and worldwide patents issued & pending. DTS is a registered trademark & the DTS logos and Symbol are trademarks of DTS, Inc. © 1996–2007 DTS, Inc. All Rights Reserved.

## HDMI

HDMI, and HDMI logo and High-Definition Multimedia Interface are trademarks or registered trademarks of HDMI licensing LLC.

# Table of contents

## General

<b>General Information .....</b>	<b>8</b>
Setup precautions.....	8
Accessories supplied .....	8
Cleaning discs .....	8
About recycling.....	8
<b>Your Product .....</b>	<b>9</b>
BDP7100 Blu-ray Disc player.....	9

## Product Overview

<b>Main Unit .....</b>	<b>10~11</b>
<b>Remote Control.....</b>	<b>12~14</b>
Preparing the remote control.....	14

## Connections

<b>Connect.....</b>	<b>15-19</b>
Connect to the TV.....	15~17
Option 1 - HDMI (best quality) .....	15
Option 2 - HDMI to DVI (best quality) .....	15
Option 3 - Component video (good quality) .....	16
Option 4 - Composite video (standard quality).....	16
Option 5 - S-Video (standard quality) .....	17
Connect to the audio system (optional) .....	17~19
Option 1 - Digital audio, optical connection (good quality) .....	17
Option 2 - Digital audio, coaxial connection (good quality) .....	18
Option 3 - 5.1 analog audio (standard quality) .....	18
Option 4 - Stereo analog audio (standard quality) .....	19
Connect to the power outlet .....	19

## Basic Setup

<b>Set Up .....</b>	<b>20-28</b>
Set the TV connection .....	20
Set the audio connection .....	20
On-Screen menu navigation .....	20
Open the Settings menu .....	21
Configure the languages .....	21~22
Open the language menu .....	21
Change the preferred audio language .....	21
Change the preferred subtitle language .....	22
Change the preferred disc menu language.....	22
Change the player language .....	22
Configure the audio output .....	22~24
Open the audio menu .....	22
Change the format of the digital audio signal .....	23
Enable PCM downsampling .....	23
Enable dynamic range compression.....	23
Change the set up of your speakers .....	24

# Table of contents

Configure the video output .....	24~26
Open the video menu .....	24
Change the aspect ratio .....	24
Enable 24fps (frame per second) .....	25
Change the resolution .....	26
Enable screen messages .....	26
Configure the front display .....	26
About HDMI CEC (Consumer Electronics Control) .....	27
Enable HDMI Setup .....	27
Change the parental setup .....	28
Open the parental setup menu .....	28
Enable the PIN .....	28
Change the rating level.....	28
Change the PIN .....	28

## Playback Functions

<b>Enjoy .....</b>	<b>29-33</b>
Turn on the Blu-ray disc player .....	29
Load a disc .....	29
Videos .....	29
Play a title .....	29
Control titles .....	30
Jump to the next or previous title .....	30
Jump to the next or previous chapter .....	30
Jump to a point of time.....	31
Search through a chapter .....	31
Play a title in slow motion .....	31
Change the audio language .....	31
Change the camera angle .....	31
Change the subtitle language .....	31
Music .....	32
Play a track .....	32
Control tracks .....	32
Pictures .....	32~33
View a picture .....	32
Start a slideshow .....	32
Rotate a picture .....	33
Zoom in and out on a picture .....	33
Set to stand-by .....	33

## Others

<b>Troubleshooting.....</b>	<b>34~35</b>
<b>Specifications .....</b>	<b>36~37</b>
<b>Glossary.....</b>	<b>38~39</b>

## General Information

### **WARNING!**

This product does not contain any user-serviceable parts. Please leave all maintenance work to qualified personnel.

### **Setup precautions**

#### **Finding a suitable location**

- Place this product on a flat, hard and stable surface. Never place the product on a carpet.
- Never place this product on top of other equipment that might heat it up (e.g., receiver or amplifier).
- Never put anything under this product (e.g., CDs, magazines).
- Never place any equipment or heavy objects on top of this product.
- Install this product near the AC outlet where the AC power plug can be easily reached.

#### **Space for ventilation**

- Place this product in a location with adequate ventilation to prevent internal heat build up. Allow at least 10 cm (4") clearance from the rear and the top of this product and 5cm (2") from the left and right to prevent overheating.

#### **Avoid high temperature, moisture, water and dust**

- This product must not be exposed to dripping or splashing.
- Never place any object or items that can damage this product (e.g., liquid filled objects, lighted candles).

### **Accessories supplied**

- 1 Remote control with batteries
- 1 Audio/Video cable
- 1 Quick Start Guide

### **Cleaning discs**

To clean a disc, use a micro fiber cleaning cloth and wipe the disc from the centre to the edge in a straight line.

### **CAUTION!**

Never use solvents such as benzene, thinner, commercially available cleaners, or anti-static sprays intended for discs.

### **About recycling**

These operating instructions have been printed on non-polluting paper. The electronic equipment contains a large number of materials that can be recycled. If you are disposing of an old machine, please take it to a recycling centre. Please observe the local regulations regarding disposal of packaging materials, exhausted batteries and old equipment.



---

---

## **BDP7100 Blu-ray Disc player**

---

---

Watch movies in the highest picture quality available for your HDTV. The BDP7100 Blu-ray Disc player offers full high-definition video playback up to 1080p resolution for an amazing viewing experience. A highly detailed picture and increased sharpness delivers a more true-to-life picture.

### **Upconvert DVDs for enhanced picture quality**

Your current DVDs will look even better than before thanks to video upconversion. Upconversion will increase the resolution of standard definition DVDs to high definition up to 1080p over an HDMI connection. The picture will be less jagged and more realistic for a near high-definition experience.

### **Enjoy your content on different kinds of media**

Full backwards compatibility with DVDs, CDs ensures that you can continue to enjoy your current audio-video collection. Additionally, you can view JPEG digital pictures or listen to MP3 music files.

### **Listen to rich uncompressed multi-channel surround sound**

The BDP7100 supports 5.1 channels of uncompressed audio, which realizes real-to-life sound and makes you feel that you are really there.

### **Intuitive User interface and Remote control**

The Philips logical user interface allows you to easily navigate through your content and settings, so you can quickly find what you are looking for.

### **Easy and simple connection to your HDTV via HDMI**

Connect your BDP7100 to your HDTV with one single HDMI (High Definition Multimedia Interface) cable. The high definition video output signal will be transferred to your HDTV without conversion to analogue signals, so you will get an excellent picture and sound quality, completely free from noise. Thanks to other multiple outputs, you can also easily connect to your home theater system or amplifier.

### **About HDMI CEC (Consumer Electronics Control)**

HDMI CEC allows linked functions of this player with HDMI CEC compliant TVs.

### **Note:**

Philips does not guarantee 100% interoperability with all HDMI CEC devices.

# Main Unit

English

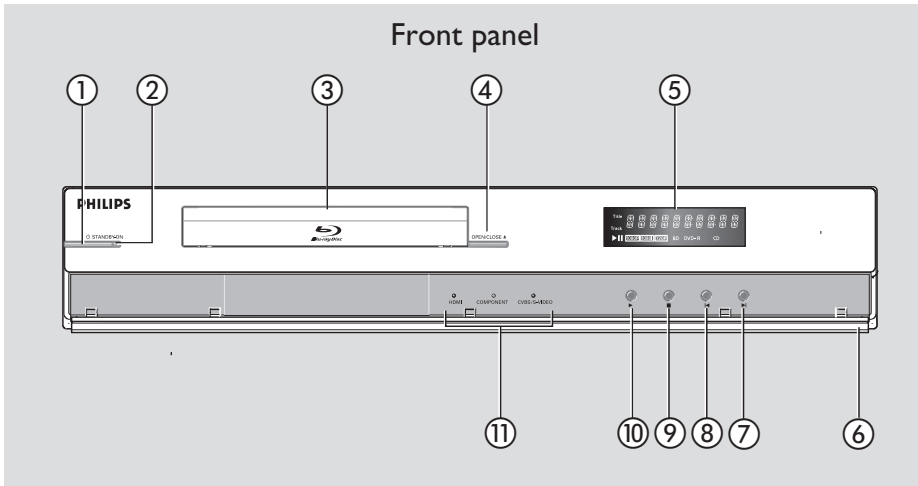

## ① **STANDBY-ON**

Turns on the player or turns off to standby mode.

## ② **Standby-on light**

Shows the on/off status of the player.

- Off - Not connected to a power supply
- Red - Stand-by mode
- Blue - On

## ③ **Disc tray**

## ④ **OPEN/CLOSE ▲**

Opens and closes the disc tray.

## ⑤ **Front display**

Shows information about the player and the disc.

## ⑥ **Cover**

Opens the user access panel.

## ⑦ **▶ (Next/Forward)**

- Videos, music, pictures - Next (short press)
- Videos, music - Forward (long press)

## ⑧ **◀ (Previous/Rewind)**

- Videos, music, pictures - Previous (short press)
- Videos, music - Rewind (long press)

## ⑨ **■ (Stop)**

## ⑩ **▶ (Play)**

## ⑪ **Video output lights**

The video output lights show the video output.

## Main Unit (continued)

English

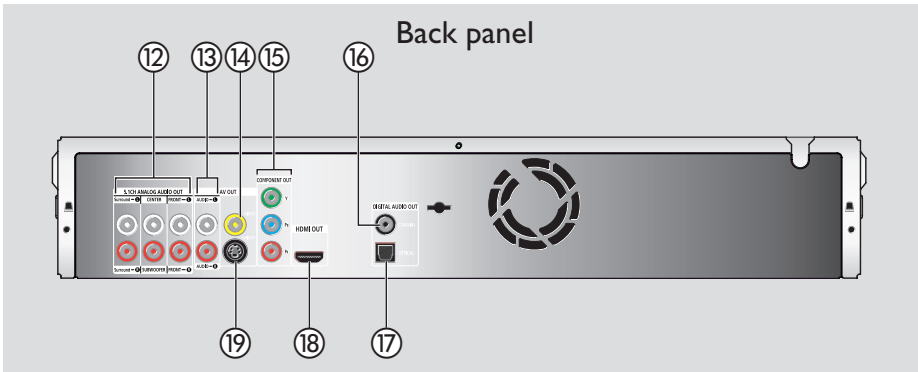

**12 5.1 CH ANALOG AUDIO OUT**

Connects the audio output to an amplifier.

**13 Stereo analogue audio sockets**

Connects the audio output to an amplifier or TV.

**14 Composite VIDEO socket (CVBS)**

**15 COMPONENT OUT (YPbPr) sockets**

**16 DIGITAL AUDIO OUT - COAXIAL**

Connects the audio output to an amplifier.

**17 DIGITAL AUDIO OUT - OPTICAL**

Connects the audio output to an amplifier.

**18 HDMI OUT**

Connects the video and audio signals to a HDMI TV or HDTV.

**19 S-VIDEO socket**

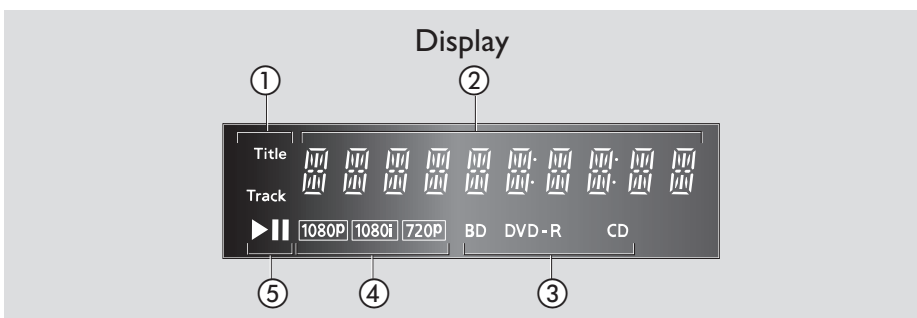

**1 Title/Track indicator**

**2 Status indicator**

Shows the information about playing time, clock and status.

**3 Disc type indicator**

**4 Video output resolution indicator**







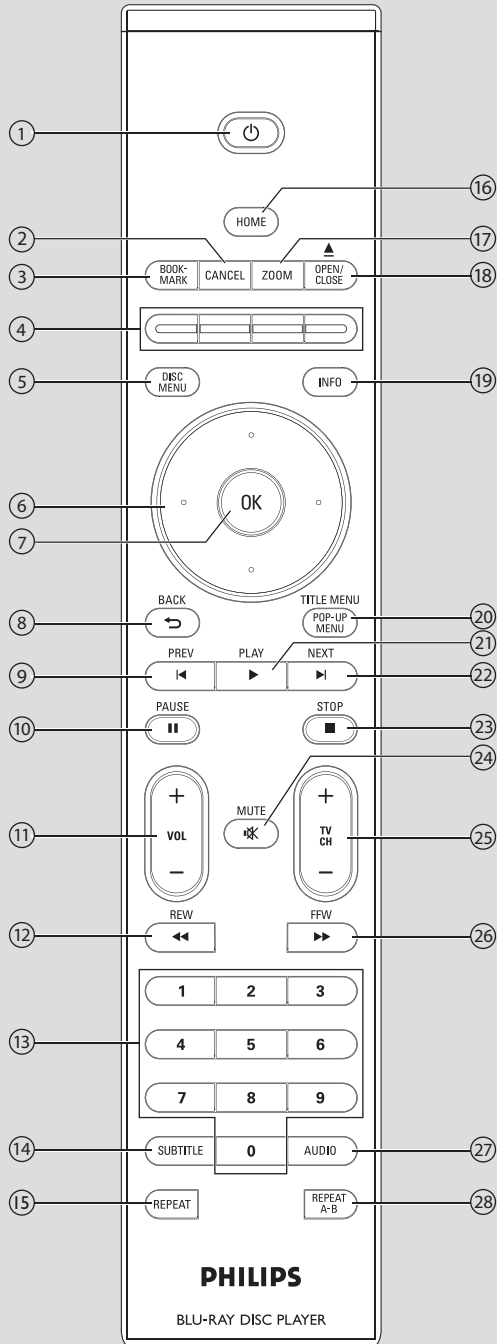



**5 Play mode indicator**

# Remote Control

English



## Remote Control (continued)

- ① **Standby-On** 
  - Turns the player on or to standby mode (short press).
- ② **CANCEL**  
Activates cancel action.
- ③ **BOOKMARK**  
Bookmarks a position or scene on the disc.
- ④ **Colour buttons**  
Activates short cut keys on BD-ROM (when available) or BD-Java's interactive operations.
- ⑤ **DISC MENU**
  - BD, DVD – Access disc menu.
- ⑥ **Cursor keys – Up, down, left and right**  
Navigates on screen display and menu.
- ⑦ **OK**  
Confirms a choice or selection.
- ⑧ **BACK**   
Returns to previous screen or menu.
- ⑨ **PREV** 
  - BD, DVD, CD – Goes to previous chapter or track.
- ⑩ **PAUSE II**  
Pauses disc playback.
- ⑪ **VOL** + –  
Adjusts TV volume. (Philips TV only)
- ⑫ **REW**   
Scans backward.
- ⑬ **Number keys**  
Enter digits: Selects numbered options in the menu (title/chapter numbers, etc.)
- ⑭ **SUBTITLE**
  - BD, DVD – Selects a subtitle language.
- ⑮ **REPEAT**  
Repeats title, chapter, track or disc.
- ⑯ **HOME**  
Access home menu.
- ⑰ **ZOOM**
  - JPEG picture – Zoom in or out.
- ⑱ **OPEN/CLOSE**   
Opens and closes the disc tray.
- ⑲ **INFO**  
Access information menu.
- ⑳ **TITLE MENU/POP-UP MENU**
  - BD – Access pop-up menu.
  - DVD – Access title menu.
- ㉑ **PLAY**   
Starts disc playback.
- ㉒ **NEXT** 
  - BD, DVD, CD – Goes to next chapter or track.
- ㉓ **STOP**   
Stops disc playback.
- ㉔ **MUTE**   
Mutes or restores the TV volume. (Philips TV only)
- ㉕ **TV CH** + –  
Selects TV channel. (Philips TV only)
- ㉖ **FFW**   
Scans forward.
- ㉗ **AUDIO**
  - BD, DVD – Selects an audio language.
- ㉘ **REPEAT A-B**  
Repeats playback a defined sequence.

## Remote Control (continued)

English

### Preparing the remote control

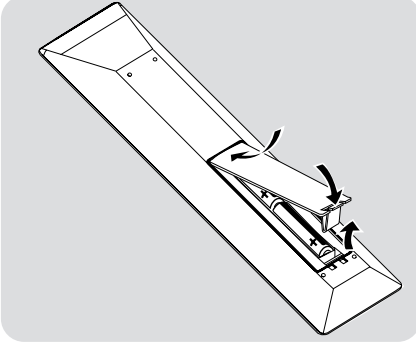

- 1 Open the battery compartment.
- 2 Insert two batteries type R06 or AA, following the indications (+ -) inside the compartment.
- 3 Close the cover.

### CAUTION!

- Remove batteries if they are exhausted or if the remote control is not to be used for a long time.
- Never mix batteries (old and new or carbon and alkaline, etc.).
- Batteries contain chemical substances, they should be disposed of properly.

## Connect to the TV

This player is designed for high-definition televisions (HDTV).

### Need help?

Refer to the documentation that came with your TV for information about:

- The devices that you can connect to your TV.
- The type of cables that you can connect to your TV.

### Option 1 - HDMI (best quality)

- 1 Take a HDMI cable (not supplied).
- 2 Plug one end of the HDMI cable into the **HDMI OUT** socket.
- 3 Plug the other end of the HDMI cable into the HD compliant TV.

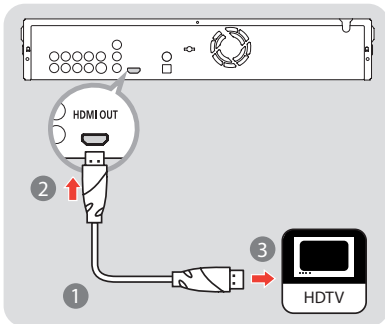

#### Helpful Hint:

– This type of connection requires no audio connection.

### Option 2 - HDMI to DVI (best quality)

- 1 Take a HDMI-DVI cable (not supplied).
- 2 Plug one end of the HDMI-DVI cable into the **HDMI OUT** socket.
- 3 Plug the other end of the HDMI-DVI cable into the HD compliant TV.

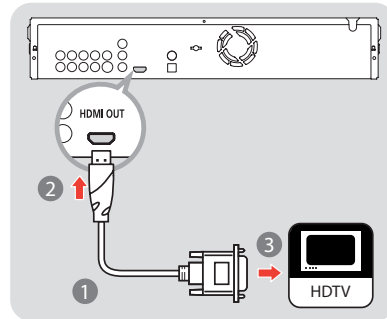

- 4 Take the supplied audio cable.
- 5 Plug one end of the audio cable into the **AUDIO-L** and **AUDIO-R** sockets.
- 6 Plug the other end of the audio cable into the TV.

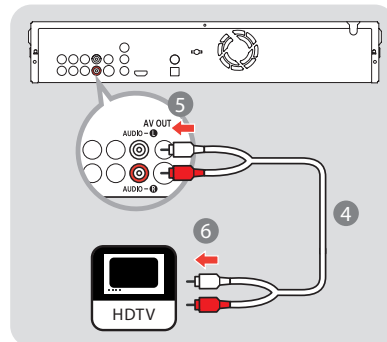

#### Helpful Hint:

– HD TV must support HDCP (High definition content protection) in order for the connection to work. Refer to your television operating instructions for more details.

## Connect (continued)

### Option 3 - Component video (good quality)

#### Note:

When a BD with Image Constraint Token or Digital Only Token is played, the output is disabled.

- 1 Take a component video cable (not supplied).
- 2 Plug one end of the component video cable into the **Y**, **Pb** and **Pr** sockets.
- 3 Plug the other end of the component video cable into the TV.

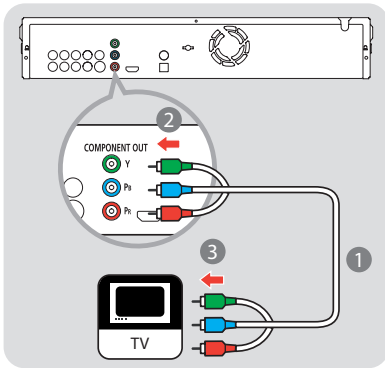

- 4 Take the supplied audio cable.
- 5 Plug one end of the audio cable into the **AUDIO-L** and **AUDIO-R** sockets.
- 6 Plug the other end of the audio cable into the TV.

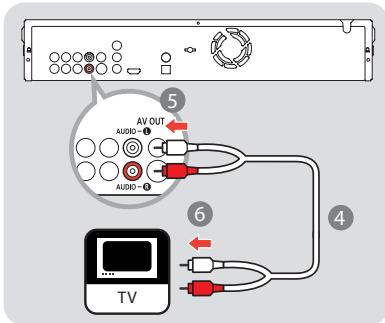

### Option 4 - Composite video (standard quality)

- 1 Take the supplied composite video cable.
- 2 Plug one end of the composite video cable into the **VIDEO** socket.
- 3 Plug the other end of the composite video cable into the TV.

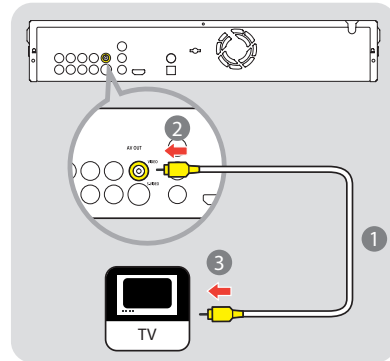

- 4 Take the supplied audio cable.
- 5 Plug one end of the audio cable into the **AUDIO-L** and **AUDIO-R** sockets.
- 6 Plug the other end of the audio cable into the TV.

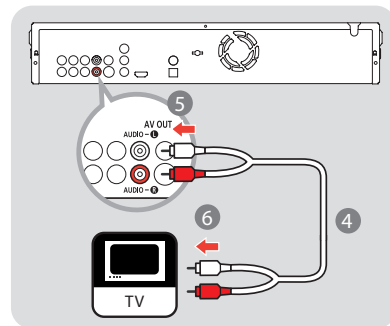



## Connect (continued)

### Option 5 - S-Video (standard quality)

- 1 Take an S-Video cable (not supplied).
- 2 Plug one end of the S-Video cable into the **S-VIDEO** socket.
- 3 Plug the other end of the S-Video cable into the TV.

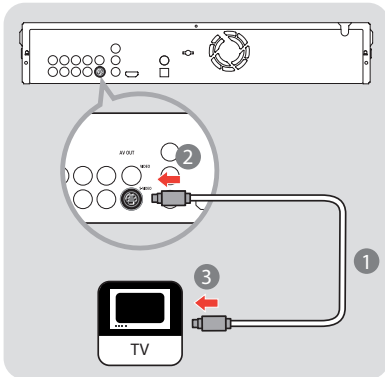

- 4 Take the supplied audio cable.
- 5 Plug one end of the audio cable into the **AUDIO-L** and **AUDIO-R** sockets.
- 6 Plug the other end of the audio cable into the TV.

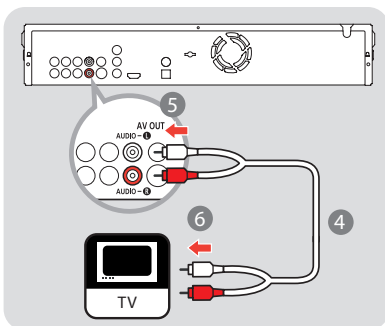

### Connect to the audio system (optional)

#### Need help?

Refer to the documentation that came with your audio system for information about:

- The devices that you can connect to your audio system.
- The type of cables that you can connect to your audio system.

### Option 1 - Digital audio, optical connection (good quality)

- 1 Take an optical audio cable (not supplied).
- 2 Plug one end of the optical audio cable into the **OPTICAL** socket.
- 3 Plug the other end of the optical audio cable into the audio system.

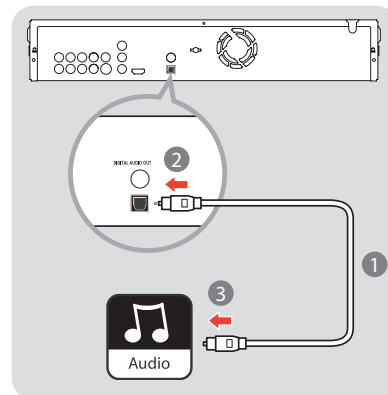

## Connect (continued)

### Option 2 - Digital audio, coaxial connection (good quality)

- 1 Take a coaxial audio cable (not supplied).
- 2 Plug one end of the coaxial audio cable into the **COAXIAL** socket.
- 3 Plug the other end of the coaxial audio cable into the audio system.

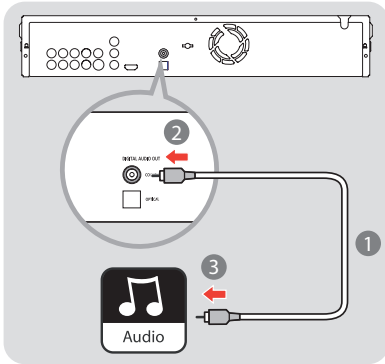

### Option 3 - 5.1 analogue audio (standard quality)

- 1 If you connected the TV to the **COMPONENT OUT, VIDEO** or **S-VIDEO** sockets or used a HDMI-DVI cable, remove the audio cable between the Blu-ray Disc player and the TV.

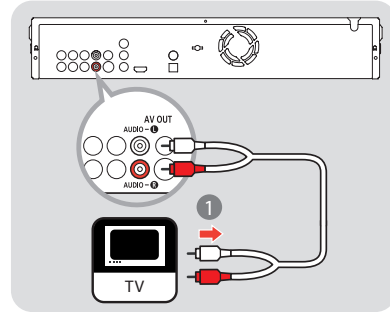

- 2 Take the supplied audio cable.
- 3 Take another two audio cables (not supplied).
- 4 Plug the three audio cables into the **5.1CH ANALOG AUDIO OUT** sockets.
- 5 Plug the other ends of the three audio cables into the audio system.

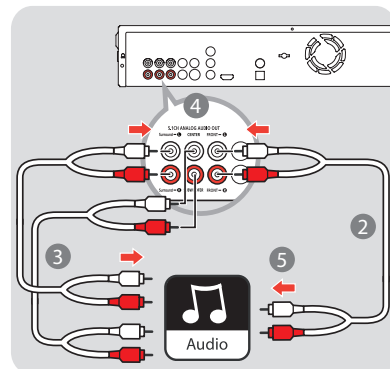

## Connect (continued)

### Option 4 - Stereo analogue audio (standard quality)

- 1 If you connected the TV to the **COMPONENT OUT**, **VIDEO** or **S-VIDEO** sockets or used a HDMI-DVI cable, unplug the audio cable on the TV.

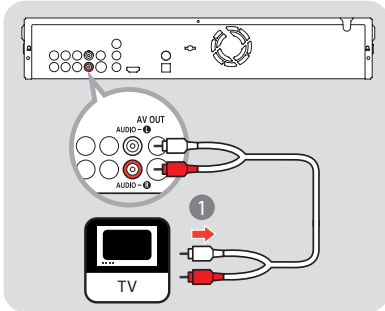

- 2 Plug the ends of the audio cable into the audio system.

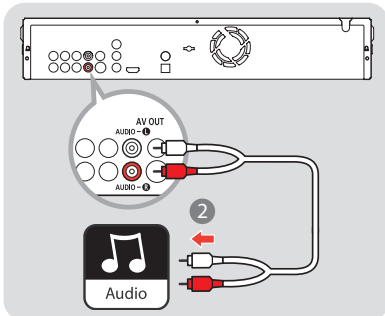

### Connect to the power outlet

The Standby-on light on the front of the player comes on as red.

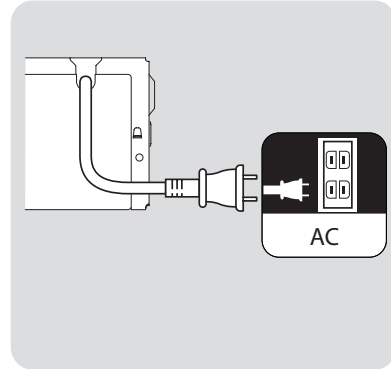

English

## Set Up

### Set the TV connection

#### Important Note:

After you have connected the BDP7100 to your TV and turn on for the first time, follow the instructions on the TV to complete the initial setup for this player. You will not be able to open the disc tray unless the initial setup is completed.

- 1 Connect the BDP7100 to your TV.
- 2 Press **STANDBY-ON** button to turn on this player.
- 3 Turn on your TV and set it to the correct viewing channel. You should see the { **MENU LANGUAGE SELECTION** } appearing on the TV.

#### MENU LANGUAGE SELECTION

Press 1 for English  
 Pulsar 2 para Español  
 Touche 3 pour Français  
 Drücken Sie 4 für Deutsch  
 Premere 5 per Italiano  
 Druk op 6 voor Nederlands  
 Prima 7 para Português

#### Note:

To search for the correct viewing channel, press the Channel Down button on the TV's remote control repeatedly (or **AV, SELECT**,  button) until you see the signal from the player appears on your TV.

- 4 Use the number keys on the remote control to select the preferred player OSD (On Screen Display) language.
- 5 Wait a few seconds for the player to finish initialising the system.

**The BDP7100 is now ready for use.**

### Set the audio connection

- 1 Turn the audio system on.
- 2 Set the audio system to the correct external input.

### On-screen menu navigation

Use the following buttons on the remote control to open and navigate through the on-screen menus.

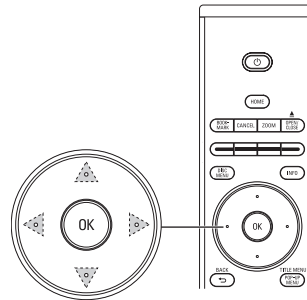

Action	Button
Go up or down in a list	cursor keys: up/down
Move a cell in the list	cursor keys: left/right
Confirm a selection	OK

## Set Up (continued)

### Open the Settings menu

With the Settings menu, you can change the set up of this player.

- 1 Press the **HOME** button on the remote control.  
→ The home menu shows.

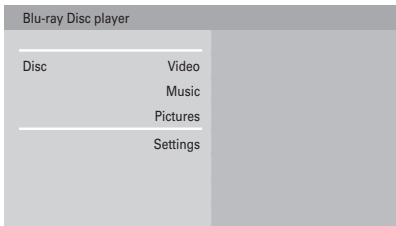

- 2 Select { **Settings** } and press **OK**.  
→ The settings menu shows.

#### Settings menu overview

Language Setup	Audio Subtitle Disc menu Player menu
Audio Ssetup	Digital output PCM downsampling Dynamic compression Speaker setup
Display Setup	TV shape Movie frame (24fps) Resolution Screen message Front display
HDMI Setup	HDMI CEC Format
Parental Setup	Use PIN Rating level New PIN

### Configure the languages

#### Open the language menu

- 1 Open the { **Settings** } menu.
- 2 Select { **Language Setup** } and press **OK**.  
→ The language setup menu shows.

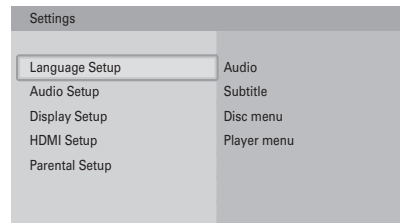

#### Change the preferred audio language

- 1 Open the { **Language Setup** } menu.
- 2 Select { **Audio** } and press **OK**.  
→ The available languages show.



- 3 Choose the preferred language and press **OK**.

#### Helpful Hint:

– When the preferred language is not available, the default language of the disc will be used.

## Set Up (continued)

### Change the preferred subtitle language

- 1 Open the { **Language Setup** } menu.
- 2 Select { **Subtitle** } and press **OK**.  
→ The available languages show.

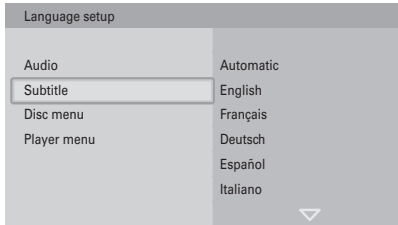

- 3 Choose the preferred language and press **OK**.

#### Helpful Hint:

– When the preferred language is not available, the default language of the disc will be used.

### Change the preferred disc menu language

- 1 Open the { **Language Setup** } menu.
- 2 Select { **Disc menu** } and press **OK**.  
→ The available languages show.

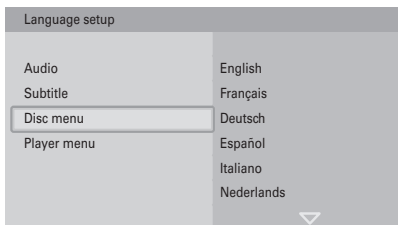

- 3 Choose the preferred language and press **OK**.

#### Helpful Hint:

– When the preferred language is not available, the default language of the disc will be used.

### Change the player language

- 1 Open the { **Language Setup** } menu.
- 2 Select { **Player menu** } and press **OK**.  
→ The available languages show.

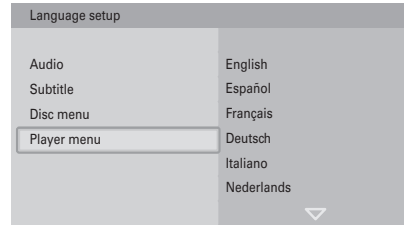

- 3 Choose the preferred language and press **OK**.

## Configure the audio output

### Open the audio menu

- 1 Open the { **Settings** } menu.
- 2 Select { **Audio Setup** } and press **OK**.  
→ The audio setup menu shows.

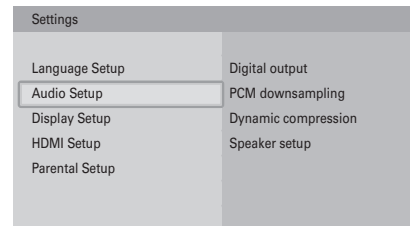

## Set Up (continued)

### Change the format of the digital audio signal

- 1 Open the { **Audio Setup** } menu.
- 2 Select { **Digital output** } and press **OK**.  
→ The available options show.

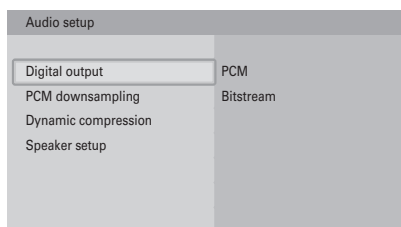

- 3 Choose the preferred option and press **OK**. See 'Audio Output' on Specification chapter for details.

Option	Description
PCM	The format of the digital audio signal is PCM.
Bitstream	The format of the digital audio signal is bitstream.

### Enable PCM downsampling

- 1 Open the { **Audio Setup** } menu.
- 2 Select { **PCM downsampling** } and press **OK**.  
→ The available options show.

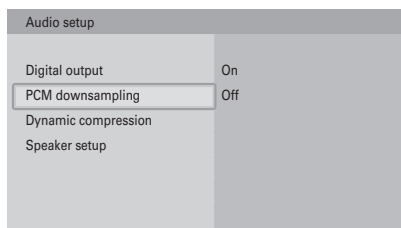

- 3 Choose the preferred option and press **OK**.

Option	Description
On	If the format of the digital audio signal is 96 kHz PCM, the audio is downsampled to 48 kHz.
Off	Regardless of the sampling frequency of the digital audio signal, the audio is never downsampled.

### Enable dynamic range compression

- 1 Open the { **Audio Setup** } menu.
- 2 Select { **Dynamic compression** } and press **OK**.  
→ The available options show.

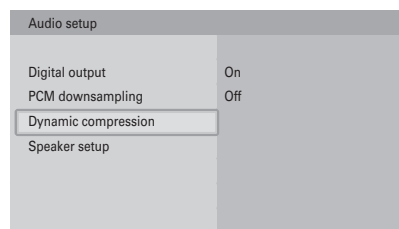

- 3 Choose the preferred option and press **OK**.

Option	Description
On	The dynamic range compression is enabled.
Off	The dynamic range compression is disabled.

## Set Up (continued)

### Change the set up of your speakers

- 1 Open the { **Audio Setup** } menu.
- 2 Select { **Speaker setup** } and press **OK**.

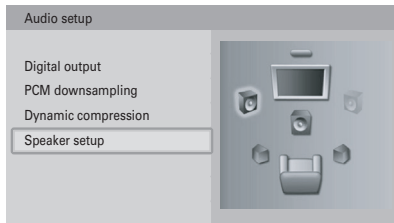

- 3 Select the speakers to change and press **OK**.

Option	Description
Front	Choose between large or small speakers.
Centre	Choose between no speaker, a large or a small speaker.
Rear	Choose between no speakers, large or small speakers.
Subwoofer	Choose between on or off. Available when front speakers are set to large.

- 4 Change the size of your speakers and press **OK**.

#### Helpful Hint:

– When the front speakers are set to large and the subwoofer is on, the subwoofer is used for the output of bass sounds (below 100 Hz). Set the subwoofer to off for output of the bass sounds through the front speakers.

### Configure the video output

#### Open the video menu

- 1 Open the { **Settings** } menu.
- 2 Select { **Display Setup** } and press **OK**.  
→ The display setup menu shows.

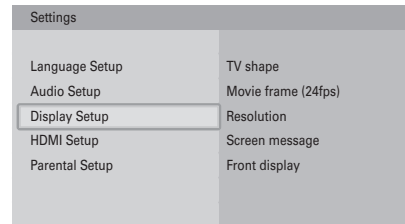

#### Change the aspect ratio

- 1 Open the { **Display Setup** } menu.
- 2 Select { **TV shape** } and press **OK**.  
→ The available options show.

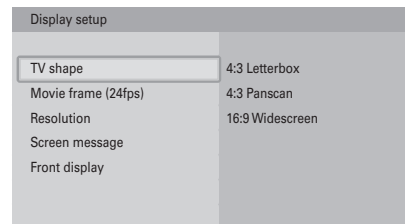



## Set Up (continued)

- 3 Choose the preferred option and press **OK**.

Option	Description
4:3 Letterbox	The TV shape is 4:3. The top and bottom parts of widescreen images show black bars. Refer to <b>A</b> .
4:3 Panscan	The TV shape is 4:3. The left and right parts of widescreen images do not show. Refer to <b>B</b> .
16:9 Widescreen	The TV shape is 16:9 (widescreen). Refer to <b>C</b> .

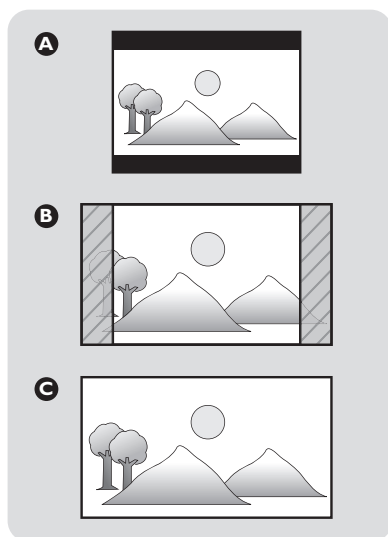

### Enable 24fps (frame per second)

Movies are usually filmed at 24fps. It only applies to TV which can support 24fps. If your TV does not support this frame rate, this menu cannot be selected.

Setting the 24fps feature to { **On** } enables the 24fps for smooth movement in Blu-ray disc film material video. This menu can only be selected in 1080i or 1080p HDMI output resolution mode.

- 1 Open the { **Display Setup** } menu.
- 2 Select { **Movie frame (24fps)** } and press **OK**.  
→ The available options show.

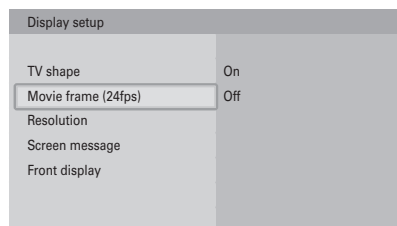

- 3 Choose the preferred option and press **OK**.

Option	Description
On	Enables 24fps output.
Off	Disable 24fps output.

## Set Up (continued)

### Change the resolution

- 1 Open the { **Display Setup** } menu.
- 2 Select { **Resolution** } and press **OK**.  
→ The available options show.

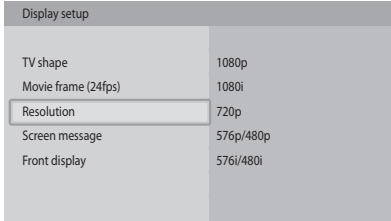

- 3 Choose the preferred option and press **OK**.

### Enable screen messages

- 1 Open the { **Display Setup** } menu.
- 2 Select { **Screen message** } and press **OK**.  
→ The available options show.

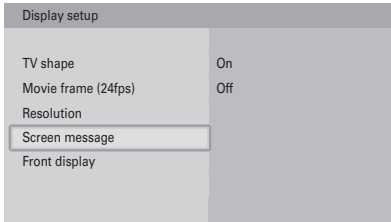

- 3 Choose the preferred option and press **OK**.

Option	Description
On	The screen messages are enabled.
Off	The screen messages are disabled.

### Configure the front display

- 1 Open the { **Display Setup** } menu.
- 2 Select { **Front display** } and press **OK**.  
→ The available options show.

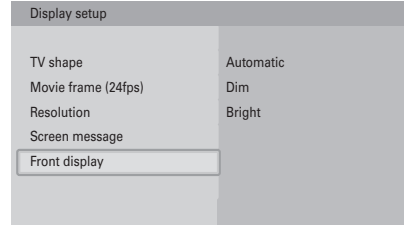

- 3 Choose the preferred option and press **OK**.

Option	Description
Automatic	Low brightness of the front display during playback.
Dim	Low brightness of the front display.
Bright	High brightness of the front display.

## Set Up (continued)

### About HDMI CEC (Consumer Electronics Control)

HDMI CEC allows linked functions of this player with HDMI CEC compliant TVs.

Connect the Blu-ray player to a HDMI CEC compliant TV with a HDMI cable.

#### Enable HDMI Setup

- 1 Open the { **Settings** } menu.
- 2 Select { **HDMI Setup** } and press **OK**.  
→ The HDMI setup menu shows.

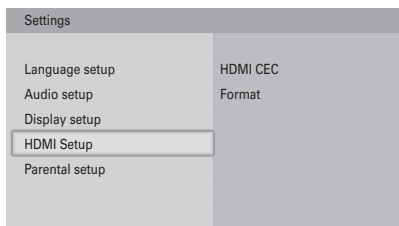

- 3 Select { **HDMI CEC** } and press **OK**.  
→ The HDMI CEC menu shows.

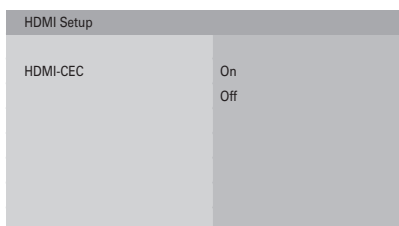

- 4 Choose the preferred option and press **OK**.

Option	Description
On	The HDMI CEC enable.
Off	The HDMI CEC disabled.

If HDMI CEC is set to { **On** }:

- When the player is turned on, the HDMI CEC compliant TV will be turned on automatically and switch to HDMI mode.
- The connected HDMI CEC compliant TV can be turn off by press and hold the  button on the Blu-ray player remote control.

#### Note:

Philips does not guarantee 100% interoperability with all HDMI CEC devices.

## Set Up (continued)

### Change the parental setup

#### Open the parental setup menu

- 1 Open the { **Settings** } menu.
- 2 Select { **Parental Setup** } and press **OK**.  
→ The parental control menu shows.

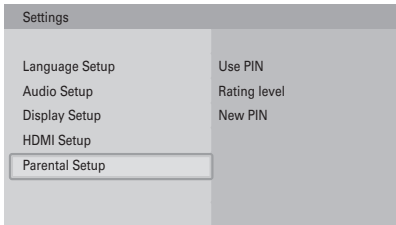

- 3 Enter your PIN.

#### Note:

The default PIN is 0000.

- 4 Follow the on-screen instructions.

#### Enable the PIN

- 1 Open the { **Parental Setup** } menu.
- 2 Select { **Use PIN** } and press **OK**.  
→ The available options show.

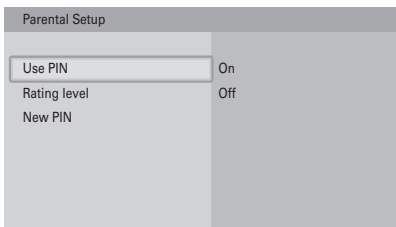

- 3 Choose the preferred option and press **OK**.

Option	Description
On	The PIN is enabled.
Off	The PIN is disabled.

#### Change the rating level

- 1 Open the { **Parental Setup** } menu.
- 2 Select { **Rating level** } and press **OK**.  
→ The available options show.

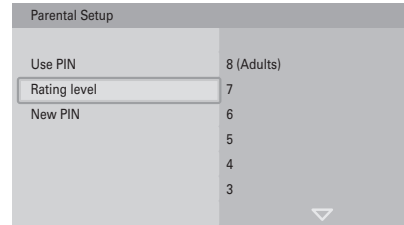

- 3 Choose the preferred option and press **OK**.

#### Helpful Hint:

– For example, when you set the rating level to 6, discs with rating levels 7 and 8 cannot be played.

#### Change the PIN

- 1 Open the { **Parental Setup** } menu.
- 2 Select { **New PIN** } and press **OK**.

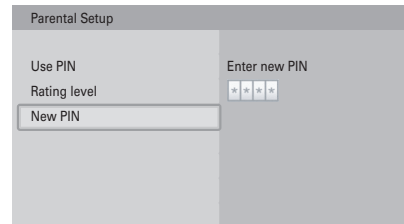

- 3 Follow the on-screen instructions.

## Turn on the Blu-ray disc player

- 1 Turn on the TV to the correct viewing channel for this player.
- 2 On the front of the player, press the **STANDBY-ON** button.  
→ The **Standby-on** light comes on as blue.

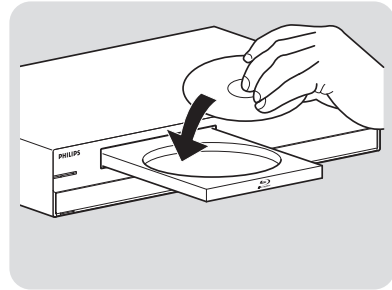
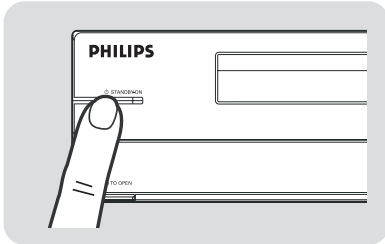

- 3 Press the **OPEN/CLOSE** button again.  
→ The disc tray closes.

## Videos

### Play a title

- 1 Turn on the Blu-ray disc player.
- 2 Load the video disc.  
→ The home menu shows.

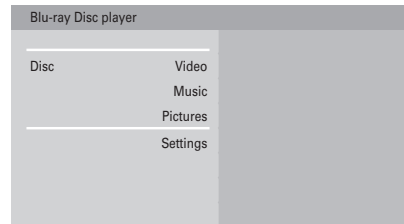

## Load a disc

Before you load a disc into the Blu-ray Disc player, make sure that the disc type is supported. See 'Playable discs' on Specifications chapter.

- 1 Press the **OPEN/CLOSE** button.  
→ The disc tray opens.

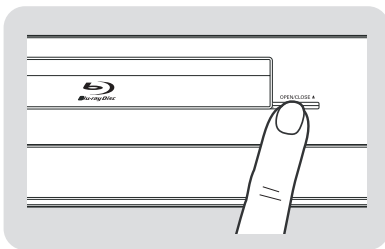

- 2 Place the disc in the disc tray.

- 3 From the home menu, select { **Video** }.  
→ The title list shows.

### Note:

Discs that contain a disc menu show the disc menu. If the disc contains a disc menu, the rest of the procedure is not applicable. Refer to the documentation that came with the disc for instructions that tell you how to operate the disc menu.

- 4 Use the remote control to go to the title.

## Enjoy (continued)

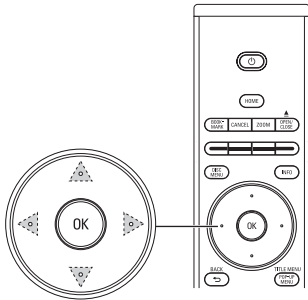

Action	Button
Previous title	cursor key: up
Next title	cursor key: down

- 5 Press the **OK** button.

### Control titles

- 1 Play the title.
- 2 Use the remote control to control the title.

Action	Button
Play/restart the title	
Pause the title	
Stop the title	
Jump to the previous title/chapter	
Jump to the next title/chapter	
Repeat the title/ chapter	
Repeat a defined selection	
Bookmark a point on the disc and press <b>OK</b> to confirm.	→

### Jump to the next or previous title

- 1 Play the title.
- 2 Press the **INFO** button.  
→ The information menu shows.
- 3 Select { **Title** }.
- 4 Select the preferred option and press **OK**.

Option	Button
Previous title	cursor key: left
Next title	cursor key: right

#### Helpful Hint:

– You can use the remote control to jump to the next or previous title. See 'Control titles' on the left for instructions.

### Jump to the next or previous chapter

- 1 Play the title.
- 2 Press the **INFO** button.  
→ The information menu shows.
- 3 Select { **Chapter** }.
- 4 Select the preferred option and press **OK**.

Option	Button
Previous chapter	cursor key: left
Next chapter	cursor key: right

#### Helpful Hint:

– You can use the remote control to jump to the next or previous chapter. See 'Control titles' on the left for instructions.

## Enjoy (continued)



### Jump to a point of time

- 1 Play the title.
- 2 Press the **INFO** button.  
→ The Information menu shows.
- 3 Select { **Playing time** }.
- 4 With the number keys, enter the point of time.
- 5 Press **OK**.

### Search through a chapter

When you search through a chapter, the audio is muted.

- 1 Play the title.
- 2 Go to the chapter.
- 3 Set the speed.

Action	Button
Search forwards	
Search backwards	

### Play a title in slow motion

When you play a title in slow motion, the audio is muted. For Blu-ray discs, only jump slow forward is possible.

- 1 Pause the title.
- 2 Set the speed.

Action	Button
Slow forward	

### Change the audio language

- 1 Play the title.
- 2 Press the **AUDIO** button.  
→ The on-screen display shows.
- 3 Select the audio language.
- 4 Press **OK**.

Action	Button
Up	cursor key: up
Down	cursor key: down

### Change the camera angle

This feature is not applicable to all video discs.

- 1 Play a title.
- 2 Press the **POP-UP MENU** button.  
→ The disc menu shows.
- 3 Select { **Angle** }.  
→ If this is unable to activate angle option, refer to the instruction that comes with the disc for more details.

### Change the subtitle language

- 1 Play the title.
- 2 Press the **SUBTITLE** button.  
→ The on-screen display shows.
- 3 Select the subtitle language.
- 4 Press **OK**.

Action	Button
Up	cursor key: up
Down	cursor key: down

## Enjoy (continued)

### Music

#### Play a track









- 1 Turn on the Blu-ray disc player.
- 2 Load the audio disc.  
→ The home menu shows.
- 3 From the home menu, select { **Music** }.  
→ The music list shows.
- 4 Use the remote control to go to the track.

Action	Button
Next track	cursor key: up
Previous track	cursor key: down

- 5 Press **OK**.

#### Control tracks

- 1 Play the track.
- 2 Use the remote control to control the track.

Action	Button
Play/restart the track	
Pause the track	
Stop the track	
Play the previous track	
Play the next track	
Repeat the track	
Repeat the audio disc	
Play the tracks in random order	

#### Helpful Hint:

– The player automatically switches to stop mode if pausing playback for more than 5 minutes. When you press **PLAY** button, the track will playback from the beginning.

### Pictures

#### View a picture

- 1 Turn on the Blu-ray disc player.
- 2 Load the disc.  
→ The home menu shows.
- 3 From the home menu, select { **Picture** }.  
→ The picture list shows.
- 4 Use the remote control to go to the picture.
- 5 Press **OK**.

#### Start a slideshow

- 1 View the first picture of the slideshow.
- 2 Press the **INFO** button.  
→ The information menu shows.
- 3 Select { **Slideshow** }.  
→ The available options show.
- 4 Choose the preferred speed and press **OK**.



## Rotate a picture

- 1 View the picture or stop the slide show.
- 2 Press the **INFO** button.  
→ The information menu shows.
- 3 Select { **Rotate** }.  
→ The available options show.
- 4 Choose the preferred option and press **OK**.

Option	Description
Rotate	cursor keys: up/down

*Helpful Hint:*

– You can use cursor left/right keys of the remote control to move to the previous/next slide.

## Zoom in and out on a picture

- 1 View the photo or stop the slide show.
- 2 Press **ZOOM** button.
- 3 Press **OK** to zoom.  
or
- 1 View the photo or stop the slide show.
- 2 Press the **INFO** button.  
→ The information menu shows.
- 3 Select { **Zoom** }.  
→ The available options show.
- 4 Choose the preferred option and press **OK**.

Option	Description
On	Zoom in
Off	Normal size (100%)
Scroll	cursor keys: up/down/left/right

## Set to stand-by

- On the front of the player, press the **STANDBY-ON** button.  
→ The **Standby-on** light on the front of your player comes on as red.

*Helpful Hint:*

– When the player is switched to stand-by, it still uses some power. To turn the player off, remove the power cord from the power outlet.

## Troubleshooting

### WARNING!

Under no circumstances should you try to repair this product yourself, as this will invalidate the warranty. Do not open this product as there is a risk of electric shock.

If a fault occurs, first check the points listed below before taking this product for repair. If you are unable to solve a problem by following these instructions, consult your dealer or Philips for help.

Be prepared to give this information:

- A description of the problem and when it occurs
- The type number on the label of the product
- The date of purchase

Problem (General)	Solution
<b>No reaction to the supplied remote control.</b>	<ul style="list-style-type: none"> <li>– Connect the player to the power outlet.</li> <li>– Point the remote control directly at the sensor of the player.</li> <li>– Insert the batteries correctly.</li> <li>– Insert new batteries in the remote control.</li> </ul>
<b>No video signal on the TV.</b>	<ul style="list-style-type: none"> <li>– Turn the TV on.</li> <li>– Turn on the TV to the correct external input.</li> </ul>
<b>Bad video signal on the connected TV.</b>	<ul style="list-style-type: none"> <li>– Clean the disc.</li> <li>– Make sure all cables are firmly inserted.</li> </ul>
<b>No high-definition video signal on the TV via component video.</b>	<ul style="list-style-type: none"> <li>– Does the disc contain high-definition video? High-definition video is not available when the disc does not contain it.</li> <li>– Does the TV support high-definition video? High-definition video is not available when the TV does not support it.</li> </ul>
<b>No audio signal.</b>	<ul style="list-style-type: none"> <li>– Increase the volume level.</li> <li>– Make sure that the audio settings of the TV are correct. Refer to the user manual of your TV.</li> <li>– Try another track or the disc.</li> </ul>
<b>No 5.1-channel audio from the loudspeakers of the audio system.</b>	<ul style="list-style-type: none"> <li>– Does the disc contain 5.1-channel audio? The 5.1-channel audio is not available when the disc does not contain it.</li> <li>– Does the audio system support 5.1-channel audio? The 5.1-channel audio is not available when the audio system does not contain it.</li> <li>– In the 'Settings' menu, set Digital out to PCM.</li> </ul>

## Troubleshooting (continued)

Problem (General)	Solution
<b>Cannot play a disc.</b>	<ul style="list-style-type: none"><li>– Make sure that the Blu-ray Disc player supports the disc type.</li><li>– Make sure that the Blu-ray Disc player supports the region code of the DVD or BD.</li><li>– Clean the disc.</li></ul>
<b>Red cross in the upper right hand corner of the screen.</b>	<ul style="list-style-type: none"><li>– The operation is not possible.</li></ul>
<b>Cannot find a JPEG file.</b>	<ul style="list-style-type: none"><li>– Make sure that the selected folder does not contain more than 1500 files. Only the first 1500 files are shown.</li><li>– Make sure that the file extension is .jpg, .JPG, .jpeg or .JPEG.</li></ul>
<b>Cannot find an MP3 file.</b>	<ul style="list-style-type: none"><li>– Make sure that the selected folder does not contain more than 1500 files. Only the first 1500 files are shown.</li><li>– Make sure that the file extension is .mp3 or .MP3</li></ul>
<b>The player gives no response to any control.</b>	<ul style="list-style-type: none"><li>– Press and hold the ⏻ STANDBY-ON button for 5 seconds to set the player to stand-by.</li></ul>

# Specifications

## Main Unit

Dimensions (w x d x h): 430 x 319 x 79 mm  
Weight: 4.3 kg

## Operating Environment

Operating temperature: 41 to 104 °F (+5 to 40 °C)  
Operating humidity: 10 to 75 % (non-condensing)

## Power

Mains power: 220~230 V, 50 Hz  
**STANDBY-ON** switch:  
Power consumption: 29 W (< 1.1 W stand-by)  
Standby-On light: Red/blue

## Video Output

D/A convertor:  
Quatization: 12 bit  
Sample rates:  
- 480i : 54MHz  
- 480p60: 108MHz  
- 720p60: 74.25MHz  
- 1080i: 74.25MHz  
HDMI: 480p, 720p, 1080i, 1080p  
Component video: 480i, 480p, 720p, 1080i  
Y: 1.0 Vp-p (75 Ω load),  
Pb: 0.70 Vp-p (75 Ω load),  
Pr: 0.70 Vp-p (75 Ω load)  
Composite video (480i): 1 channel: 1.0 Vp-p  
(75 Ω load)  
S-Video (480i): Luminance: 1.0 Vp-p (75 Ω load),  
Chrominance: 0.3 Vp-p (75 Ω load)

## Audio Output

D/A converter : 24bit / 192kHz  
HDMI: PCM multi-channel audio, PCM audio,  
bitstream audio  
Digital audio output: Optical, coaxial (S/PDIF)  
5.1-Channel: Front and rear left,  
front and rear right,  
centre, subwoofer  
2-Channel: Left, right  
Frequency response:  
4 Hz~44 kHz at sampling rate 96 kHz

Signal-to-noise ratio: 120dB (None Weighting)  
Dynamic range: 103dB with DVD Video  
Total harmonic distortion: 0.004%

When you play a video from a disc, the audio is dependent upon:

- The type of audio connection
- The disc type and the audio on the disc
- The selected digital audio format (only for S/PDIF and HDMI connections)

## Playable Discs

Types BD-ROM/R\*/RE\*, DVD-Video,  
DVD-R/RW (Video),  
Audio CD, CD-R/RW  
Region codes BD: B; DVD: 2

\* *Due to the intentional progression of the Blu-ray Disc format by its standard setting authority, Philips cannot guarantee or warrant the playability of future extensions of the Blu-ray Disc format with this product.*

## Remote Control

### Infra-red capabilities

Operating distance 6000 mm (maximum)  
Transmitting LEDs 1  
Carrier frequency range 36 kHz  
Transmission angle ± 15 degrees

### Dimensions

Product dimensions (w x d x h) 237 x 46 x 24.5 mm  
Product weight (excluding batteries) 176 g

### Power

Number of batteries 2  
Battery type AA

## Specifications (continued)

English

PRODUCT IS COMPATIBLE WITH THE FOLLOWING CURRENT FORMATS:

- BD-ROM/R\*/RE\*
- DVD-Video, DVD-R/RW (Video),
- Audio CD, CD-R/RW

PRODUCT WILL NOT PLAY DISCS WITH THE FOLLOWING FORMATS:

- HD DVD
  - Any other
- \* Due to the intentional progression of the Blu-ray Disc format by its standard setting authority, Philips cannot guarantee or warrant the playability of future extensions of the Blu-ray Disc format with this product.*

### Notes:

- Specifications are subject to change without prior notice.
- Weight and dimensions are approximate.

## Glossary

---

**AUDIO-CD:** Audio CD.

**BD:** Blu-ray Disc.

**BD-R:** BD Recordable. You can record a BD-R once and you cannot erase it.

**BD-RE:** BD Rewritable. You can record a BD-RE over and over again. For example, you can use a BD-RE to make sequential back-ups.

**BD-ROM:** BD Read Only Memory. A BD-ROM contains recorded data. For example, high-definition videos.

**CD:** Compact Disc.

**CD-R:** CD Recordable. You can record a CD-R once and you cannot erase it. For example, you can use it to archive data.

**CD-RW:** CD Rewritable. You can record a CD-RW over and over again. For example, you can use a CD-RW to make sequential back-ups.

**Chapter:** Sections of a video or a music track.

**CVBS:** Composite video. A type of video signal.

**Dolby Digital:** A surround sound system developed by Dolby Laboratories containing up to six channels of digital audio (front left and right, surround left and right, centre and subwoofer).

**Dolby Digital Plus:** The next-generation audio technology that delivers 'better-than-DVD' sound for all high-definition media providing up to 7.1 channels of audio. It is for the future, but remains fully compatible with existing Dolby Digital home entertainment systems.

**Dolby TrueHD:** Dolby's next-generation lossless technology developed for high-definition disc-based media that delivers true high-definition sound, while providing up to 7.1 channels of lossless audio that is bit-for-bit identical to the studio master.

**DTS:** Digital Theater Systems. This is a surround sound system, but it is different from the Dolby Digital. The formats were developed by different companies.

**DTS-HD High Resolution Audio:** Offers sound quality significantly better than current DVD, providing up to 7.1 channels of audio and secondary audio streams. It is also fully compatible with existing DTS capable home entertainment systems.

**DVD:** Digital Versatile Disc.

**DVD-VIDEO:** DVD Video.

## Glossary (continued)

**DVD+/-R:** DVD Recordable. You can record a DVD+/-R once and you cannot erase it. For example, you can use it to archive data.

**DVD+/-RW:** DVD Rewritable. You can record a DVD+/-RW over and over again. For example, you can use a DVD+/-RW to make sequential back-ups.

**GB:** Gigabyte.

**HDMI:** High Definition Media Interface. It is a direct digital connection that can carry digital high-definition video as well as digital multi-channel audio.

**JPEG:** Data compression standard for digital images.

**kbps:** Kilobit per second (1000 bit/s).

**MP3:** Data compression standard for digital audio.

**PCM:** Pulse Code Modulation. A digital audio encoding system.

**Title:** A complete video on a disc.

**Track:** A music track on a disc.

Meet Philips at the Internet  
<http://www.philips.com/welcome>

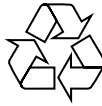

BDP7100



AK68-01471A



Sgpjp-0735/12-1