

Use and Care Guide



KitchenAid®

FOR THE WAY IT'S MADE.™

A Note to You	2
Range Safety	3-5
Getting to Know Your Range	6
Using and Caring for Your Cooktop	9
Using and Caring for Your Oven	14
Using the Self-Cleaning Cycle ...	36
If You Need Assistance or Service	40
Warranty	44

1-800-422-1230

Call us with questions or comments.

KITCHENAID®
Electric Range

Model: KERI500

A Note to You

Thank you for buying a KITCHENAID® appliance!

KitchenAid designs the best tools for the most important room in your house. To ensure that you enjoy many years of trouble-free operation, we developed this Use and Care Guide. It contains valuable information concerning how to operate and maintain your new appliance properly and safely. Please read it carefully.

Also, please complete and mail the enclosed Product Registration Card.

Please record your model's information.

Whenever you call our Consumer Assistance Center at **1-800-422-1230** or request service for your appliance, you need to know your complete model number and serial number. You can find this information on the model and serial number plate (see diagram on page 6 for location of plate).

Please also record the purchase information.

NOTE: You must provide proof of purchase or installation date for in-warranty service.

Keep this book and the sales slip together in a safe place for future reference.

Model Number _____

Serial Number _____

**Purchase/
Installation Date** _____

**Builder/Dealer
Name** _____

Address _____

Phone _____

Range Safety

IMPORTANT SAFETY INSTRUCTIONS

Your safety is important to us.

This guide contains safety symbols and statements. Please pay special attention to these symbols and follow any instructions given. Here is a brief explanation of the use of the symbol.



This symbol alerts you to hazards such as fire, electrical shock, or other injuries.

WARNING

To reduce the risk of fire, electrical shock, injury to persons, or damage when using the range, follow basic precautions, including the following:

General

- Read all instructions before using the range.
- Install or locate the range only in accordance with the provided Installation Instructions. The range must be installed by a qualified installer. The range must be properly connected to electrical supply and grounded.



- **WARNING:** To reduce the risk of tipping the appliance, the appliance must be secured by a properly installed anti-tip bracket. To check if the bracket is installed properly, see “The anti-tip bracket” on page 8.
- **CAUTION:** Do not store things children might want above the range. Children could be burned or injured while climbing on it.
- Do not leave children alone or unattended in area where the range is in use. They should never be allowed to sit or stand on any part of the range. They could be burned or injured.

- Do not use the range for warming or heating the room. Persons could be burned or injured, or a fire could start.
- Use the range only for its intended use as described in this manual.



- Do not touch surface units, areas near units, heating elements, or interior surfaces of oven. Surface units and heating elements may be hot even though they are dark in color. Areas near surface units and interior surfaces of an oven become hot enough to cause burns. During and after use, do not touch, or let clothing or other flammable materials contact surface units, areas near units, heating elements, or interior surfaces of oven until they have had sufficient time to cool. Other surfaces of the range, such as the oven vent opening, the surface near the vent opening, the cooktop, and the oven door and window, could also become hot enough to cause burns.



- Do not operate the range if it is damaged or not working properly.



- Do not wear loose or hanging garments when using the range. They could ignite if they touch a hot surface unit and you could be burned.
- Use only dry pot holders. Moist or damp pot holders on hot surfaces could result in burns from steam. Do not let pot holder touch hot heating elements. Do not use a towel or bulky cloth for a pot holder. It could catch on fire.
- Keep range vents unobstructed.
- Do not heat unopened containers. They could explode. The hot contents could cause burns and container particles could cause injury.
- Use only cookware approved for oven use. Follow cookware manufacturer's instructions, especially when using glass or plastic cookware.
- Do not store flammable materials on or near the range. The fumes could create an explosion and/or fire hazard.
- Do not repair or replace any part of the range unless specifically recommended in this manual. All other servicing should be referred to a qualified technician.
- Disconnect the electrical supply before servicing the range.

When using the cooktop

- Make sure the reflector bowls are in place during cooking. Cooking without reflector bowls could subject the wiring and components underneath them to damage.
- Do not line reflector bowls with aluminum foil or other liners. Improper installation of these liners could result in a risk of electrical shock or fire.
- Select a pan with a flat bottom that is about the same size as the surface unit. If pan is smaller than the surface unit, some of the heating element will be exposed and could result in the igniting of clothing or pot holders. Correct pan size also improves cooking efficiency.
- Check to be sure glass cookware is safe for use on the range. Only certain types of glass, glass-ceramic, ceramic, earthenware, or other glazed cookware are suitable for cooktops without breaking due to the sudden change in temperature.
- Never leave surface units unattended at high heat settings. A boilover could result and cause smoking and greasy spillovers that could ignite.



- Turn pan handles inward, but not over other surface units. This will help reduce the chance of burns, igniting of flammable materials, and spills due to bumping of the pan.
- Grease is flammable. Do not allow grease to collect around cooktop or in vents. Wipe spillovers immediately.



- Do not use water on grease fires. Never pick up a flaming pan. Smother flaming pan on range by covering with a well-fitting lid, cookie sheet, or flat tray. Flaming grease outside of pan can be extinguished with baking soda or, if available, a multipurpose dry chemical, or foam-type extinguisher.
- Do not soak removable heating elements in water. The element will be damaged and shock or fire could result.

When using the oven

- Always position oven rack(s) in desired location while oven is cool. If a rack must be removed while oven is hot, do not let pot holder contact hot heating elements in oven.

- Use care when opening oven door. Let hot air or steam escape before removing or replacing food.
- Small amounts of formaldehyde and carbon monoxide are given off in the Self-Cleaning cycle from fiberglass insulation and food decomposition. Significant exposure to these substances could cause cancer or reproductive harm. Exposure can be minimized by venting with a hood or open window and wiping out excess food spills prior to self-cleaning.



- Do not use oven cleaners. No commercial oven cleaner or oven liner protective coating of any kind should be used in or around any part of the oven.
- Before self-cleaning the oven, remove broiler pan, broiler grid, oven racks, and other cookware. Do not use your oven to clean miscellaneous parts unless you are instructed to do so in this Use and Care Guide.
- Do not clean door gasket. It is essential for a good seal. Care should be taken not to rub, damage, or move the gasket. Clean only parts recommended in this Use and Care Guide.

– SAVE THESE INSTRUCTIONS –

Getting to Know Your Range

This section tells you what features your range has and where they are located. It also discusses some safety and convenience features that you should know about, but which are not needed to operate the range. Please review this information before using your range.

Feature locations

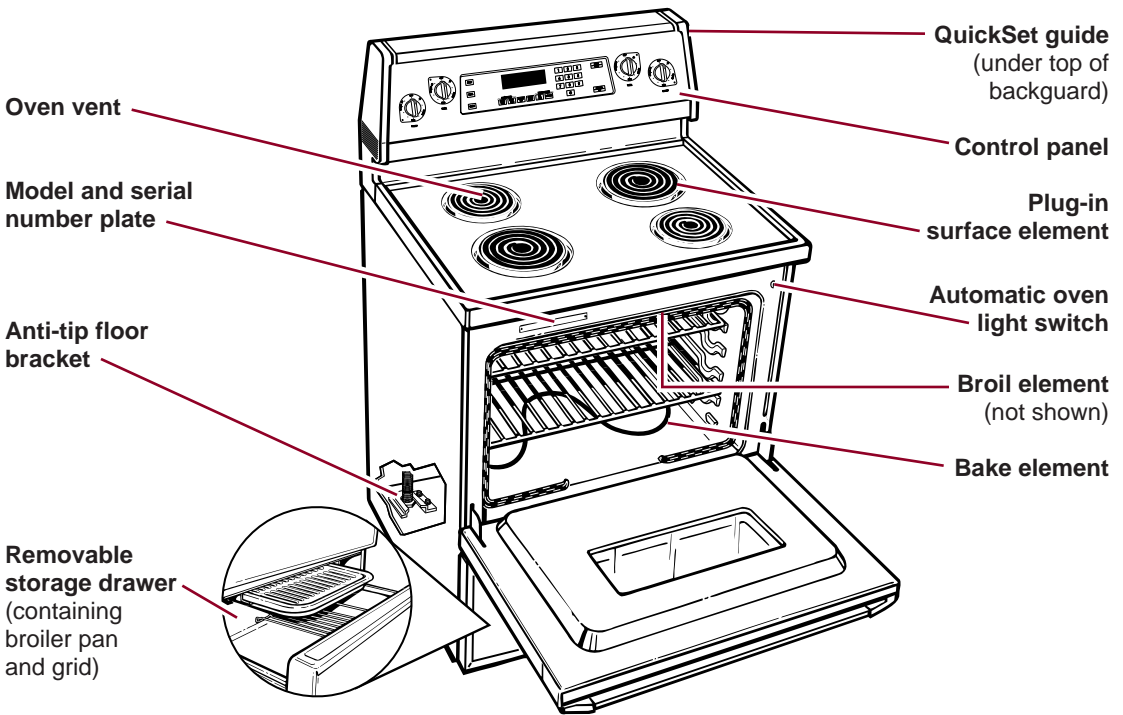

Control panel

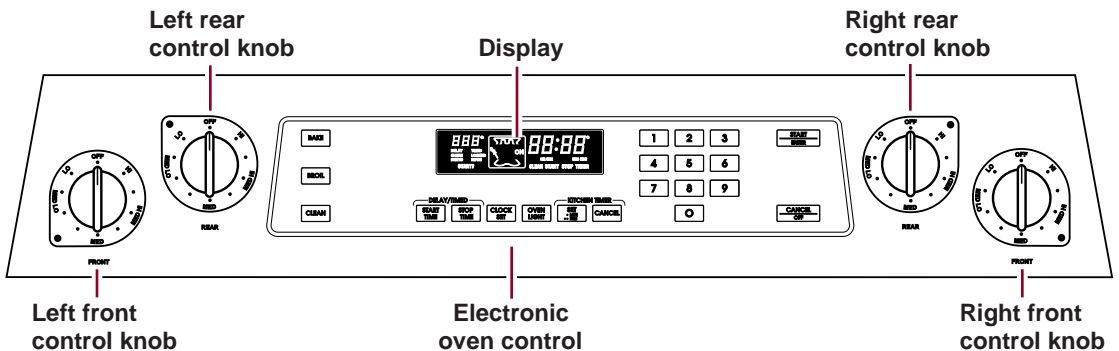



The oven vent

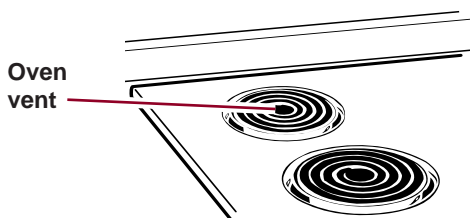

Hot air and moisture escape from the oven through a vent under the left rear surface unit. You can cook on the unit or keep food warm on it while the oven is on. The vent is needed for air circulation. **Do not block the vent by using large pans or covers.** Poor baking/roasting can result.

NOTE: Plastic utensils left over the vent can melt.

! WARNING



Burn Hazard

Use pot holders when touching items left near oven vent.

Failure to do so can result in burns.

The storage drawer

You can remove the storage drawer to make it easier to clean under the range and to check for installation of the anti-tip bracket. **Use care when handling the drawer.**

Removing the storage drawer:

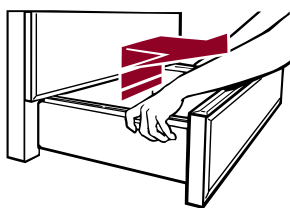

- 1. Empty** drawer of any pots and pans before removing drawer. **Use** recessed area on top edge of drawer to pull drawer straight out to the first stop. **Lift** front and **pull out** to the second stop.
- 2. Lift** back slightly and **slide** drawer all the way out.

Replacing the storage drawer:

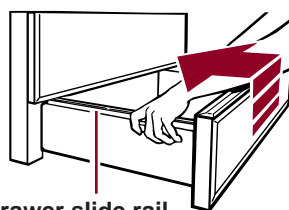

Drawer slide rail

- 1. Fit** ends of drawer slide rails into the drawer guides on both sides of opening.
- 2. Lift** drawer front and **press in** until metal stops on drawer slide rails clear white stops on drawer guides. **Lift** drawer front again to clear second stop and **slide** drawer closed.



The anti-tip bracket

The range will not tip during normal use. However, tipping can occur if you apply too much force or weight to the open door without the anti-tip bracket properly secured.

	⚠ WARNING
	<p>Tip Over Hazard</p> <p>Connect anti-tip bracket to the range.</p> <p>Reconnect anti-tip bracket, if the range is moved.</p> <p>Do not push down on the open oven door.</p> <p>Follow the Installation Instructions.</p> <p>Do not let children climb onto the oven door.</p> <p>Failure to follow these instructions can result in death, burns, or other injury.</p>

To verify the anti-tip bracket is engaged:

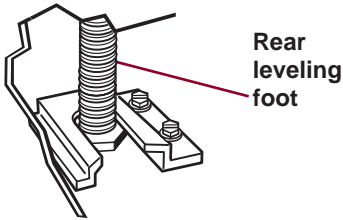

- **Remove** the storage drawer.
(See page 7.)
- **Look** to see if the anti-tip bracket is attached to floor with screws.
- **Make sure** left rear leveling foot is positioned under the anti-tip bracket.
- **See** Installation Instructions for further details.

Using and Caring for Your Cooktop

This section tells you how to operate the controls to the cooktop. It also includes tips on how to cook with and maintain the cooktop.

IN THIS SECTION

Using the surface units	9	Caring for your cooktop	11
Cookware tips	10	Cleaning your cooktop	13

Using the surface units

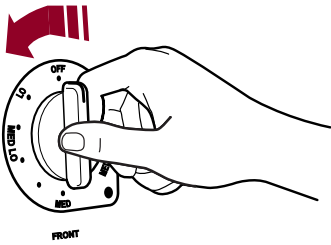

Control knobs

Push in control knobs before turning them to a setting. Set them anywhere between HI and OFF.

Power on lights

Each control knob has a Power On Light. When you use a control knob to turn on a surface unit, the Power On Light by that knob will glow.



! WARNING



Fire Hazard

Turn off all controls when done cooking.

Failure to do so can result in death, fire, or burns.

Control setting guide

For best results, start cooking at the high setting; then turn the control knob down to continue cooking.

SETTING	RECOMMENDED USE
HI	<ul style="list-style-type: none"> To start foods cooking. To bring liquids to a boil.
MED HI	<ul style="list-style-type: none"> To hold a rapid boil. To fry chicken or pancakes.
MED	<ul style="list-style-type: none"> For gravy, pudding, and icing. To cook large amounts of vegetables.
MED LO	<ul style="list-style-type: none"> To keep food cooking after starting it on a higher setting.
LO	<ul style="list-style-type: none"> To keep food warm until ready to serve.



Cookware tips

- **Select a pan** that is about the same size as the surface unit.



- **NOTE:** For best results and greater energy efficiency, use only flat-bottomed cookware that makes good contact with the surface units. Cookware with rounded, warped, ribbed (such as some porcelain enamelware), or dented bottoms could cause severe overheating, which damages the cookware and/or surface unit.

You can, however, use the newer cookware available with slightly indented bottoms or very small expansion channels. This cookware is specially designed to provide the good contact needed for best cooking results.

Also, woks, canners, and teakettles with flat bottoms suitable for use on your cooktop are now available in most stores that sell housewares.

- **The pan** should have straight sides and a tight-fitting lid.
- **Choose medium to heavy gauge** (thickness) pans that are fairly lightweight.
- **The pan material** (metal or glass) affects how fast heat transfers from the surface unit through the pan material and how evenly heat spreads over the pan bottom. Choose pans that provide the best cooking results.
- **Handles** should be made of sturdy, heat-resistant material and be securely attached to the pan.

NOTE: Do not leave empty cookware, or cookware which has boiled dry, on a hot surface unit. The cookware could overheat and damage the cookware or surface unit.

Home canning information



- **Use the largest surface unit** for best results. Also, use a canner/pan which can be centered over the surface unit and which does not extend more than 1 inch outside surface unit area. Large diameter canners/pans, if not properly centered, trap heat and can cause damage to the cooktop.
- **Start with hot water.** This reduces the time the control is set on high. Reduce heat setting to lowest position needed to keep water boiling.
- **Keep reflector bowls clean** for best heat reflection.
- **Refer** to your canner manual for specific instructions.

Optional canning kit

The large diameter of most water-bath or pressure canners combined with high heat settings for long periods of time can shorten the life of regular surface units and cause damage to the cooktop.

If you plan to use the cooktop for canning, we recommend the installation of a Canning Kit. Order the kit (Part No. 242905) from your KitchenAid dealer, or call **1-800-422-1230** and follow the instructions and telephone prompts you hear.



Caring for your cooktop

Your cooktop is designed for easy care. You can do most cleaning with items found around your home. Cleaning your cooktop whenever spills or soiling occurs will help to keep it looking and operating like new.

NOTE: Let cooktop cool before cleaning.

Removing surface units and reflector bowls for cleaning

Removing

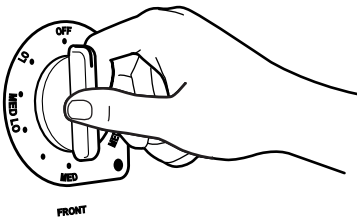

1. **Make sure** all surface units are off and cool before removing surface units and reflector bowls.

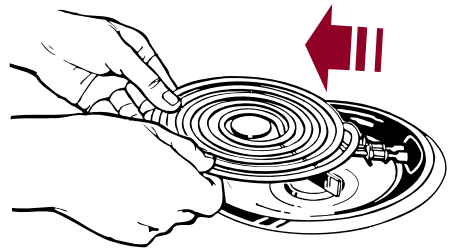

3. **Pull** the surface unit straight away from the receptacle.

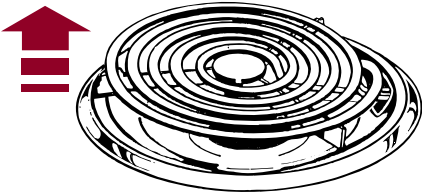

2. **Lift** the edge of the unit, opposite the receptacle, just enough to clear the reflector bowl.

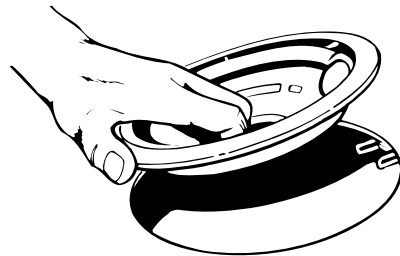

4. **Lift out** the reflector bowl. See "Cleaning your cooktop" on page 13 for cleaning instructions.



Using and Caring for Your Cooktop

Replacing

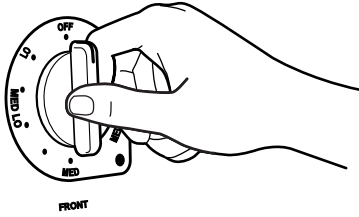

1. **Make sure** all surface units are off and cool before replacing surface units and reflector bowls.



2. **Line up** openings in the reflector bowl with the surface unit receptacle.

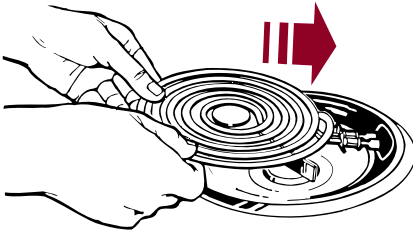

3. **Hold** the surface unit as level as possible with the terminal just started into the receptacle. **Push** the surface unit terminal into the receptacle.



4. When terminal is pushed into the receptacle as far as it will go, push **down** the edge of the surface unit opposite the receptacle.

NOTE: Reflector bowls reflect heat back to the cookware on the surface units. They also help catch spills. When they are kept clean, they reflect heat better and look new longer.

If a reflector bowl gets discolored, some of your cookware may not be flat enough, or some may be too large for the surface unit. In either case, some of the heat that's meant to go into or around cookware goes down and heats the reflector bowl. This extra heat can discolor it.

Cleaning under the lift-up cooktop

1. **Lift** front of cooktop at both front corners until the support rods lock into place.

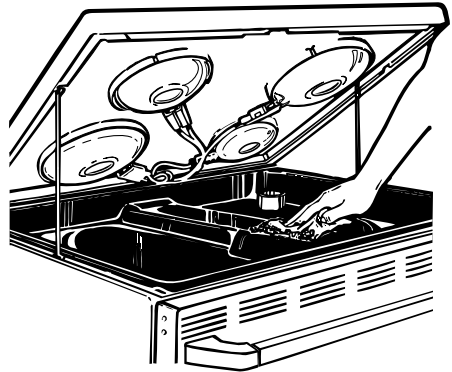

2. **Wipe** with warm, soapy water. **Use** a soapy steel-wool pad on heavily soiled areas.
3. **To lower the cooktop**, lift cooktop from both sides while pushing the support rods back to unlock them. **Lower** the cooktop into place.



Cleaning your cooktop



⚠️ WARNING

Explosion Hazard

Do not store flammable materials such as gasoline near this appliance.

Doing so can result in death, explosion, fire, or burns.

PART	WHAT TO USE	HOW TO CLEAN
Coil element surface units	No cleaning required	<ul style="list-style-type: none"> • Spatters or spills will burn off. • Do not immerse in water.
Porcelain-enamel reflector bowls	Nonabrasive, plastic scrubbing pad and warm, soapy water OR The Self-Cleaning cycle	<ul style="list-style-type: none"> • Wipe off excess spills. • Wash, rinse, and dry thoroughly. <p>OR</p> <ul style="list-style-type: none"> • Place upside down on oven racks in oven during the Self-Cleaning cycle.
Cooktop surface	Sponge and warm, soapy water	<ul style="list-style-type: none"> • Wash, wipe with clean water, and dry thoroughly. • Use nonabrasive, plastic scrubbing pad on heavily soiled areas. • Do not use abrasive or harsh cleansers. They may damage the finish. <p>NOTE: Do not allow foods containing acids (such as vinegar, tomato, or lemon juice) to remain on surface. Acids may remove the glossy finish. Also wipe up milk or egg spills when cooktop is cool.</p>

Using and Caring for Your Oven

This section tells you, step by step, how to operate all oven functions controlled by the electronic control. Carefully follow these instructions, along with the cooking tips and cleaning information, for successful use of your range.

IN THIS SECTION

Using the electronic oven control	14	Timed cooking	25
Setting the clock	16	Cooking tips	28
Using the kitchen timer	16	Cleaning your oven and controls	33
Baking/roasting	18	Using and replacing the oven light(s)	35
Adjusting oven temperature	20		
Broiling	22		

Using the electronic oven control

For a quick reference guide on using the electronic oven control, see the QuickSet Guide under top of backguard.

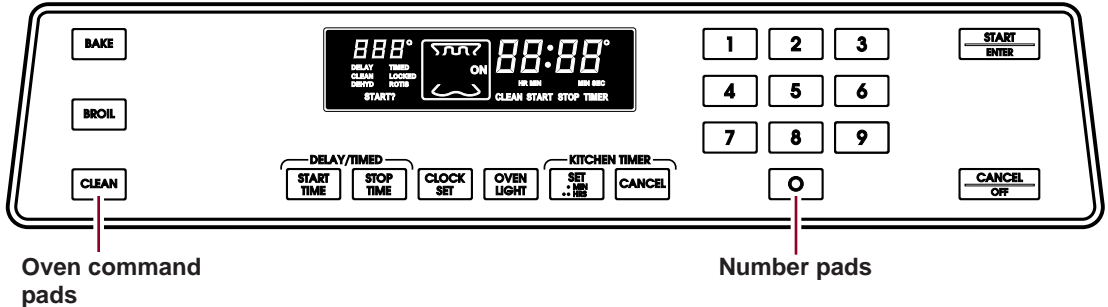

Display/clock

- When you first plug in the range, a tone will sound and the display will show “88:88.” If, after you set the clock (page 16), the display again shows “88:88,” your electricity was off for a while. Reset the clock.
- The time display will show “Err” and three short tones will sound if a time or temperature is incorrectly entered.

Starting an operation



After programming a function, you must press the Start/Enter pad to start the function. If you do not press the Start/Enter pad within 5 seconds of programming, “START?” will show in the display as a reminder.



Canceling an operation



The Cancel/Off pad will cancel any function, except for the Clock Set and Kitchen Timer functions. When you press the Cancel/Off pad, the large display will show the time of day.

Changing audible signals

Audible signals tell you if a function is entered correctly or not. They also tell you when a cycle is completed.

To shut off audible signals during programming:

PRESS
and hold
for 4
seconds



To shut off all signals except for the end-of-timer tone:

PRESS
and hold
for 4
seconds



To change the end-of-timer tone to a 4-second tone:

PRESS
and hold
for 4
seconds



A short tone will sound to tell you the signals have been changed. Repeat step above to turn the signals back on.



Setting the clock

1. Choose Clock Set.

PRESS



Example:
YOU SEE



2. Set Time.

Example:
PRESS



Example:
YOU SEE



3. Start clock.

PRESS



If the time has not been entered correctly, three short tones will sound and “Err” is displayed for 1 second. The previous display then reappears. Repeat Steps 1, 2, and 3 to re-enter the time of day.

Using the kitchen timer

The Kitchen Timer does not start or stop the oven. It works like a regular kitchen timer. It can be set in hours and minutes up to 99 hours, 99 minutes, or in minutes and seconds up to 99 minutes, 99 seconds.

1. Choose Kitchen Timer.

PRESS
once to
count down
minutes
and seconds



YOU SEE

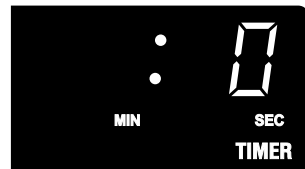



PRESS
twice to
count down
hours and
minutes



YOU SEE



2. Set time.

Example:
PRESS



Example:
YOU SEE

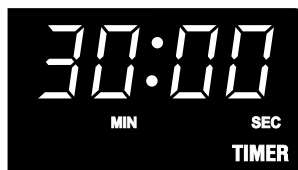

3. Start Kitchen Timer.

PRESS



The Kitchen Timer will begin counting down immediately after you press the Start/Enter pad.

When time is up, you will hear a single tone that sounds every 5 seconds.

PRESS
to turn off tone



YOU SEE



NOTE: To change the end-of-timer tone to a 4-second tone, press and hold the Kitchen Timer Set pad for 4 seconds. A short tone will sound to tell you the tone has been changed.

To cancel the kitchen timer:

PRESS





Baking/roasting

1. Prepare oven.

Position the rack(s) properly. For correct rack placement, see “Rack positions” on page 28 and “Rack placement” chart on page 29. When roasting, place food in the oven. For large roasts and turkeys, place rack in position 1 (closest to oven bottom).

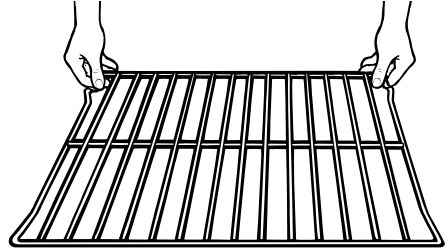

2. Choose setting.

PRESS

BAKE

YOU SEE

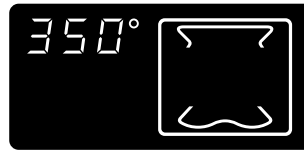

3. Set temperature (optional).

Do this step if you want to set a temperature other than 350°F.

Example:
PRESS

3

7

5

Example:
YOU SEE



(See the “Baking chart” on page 30 or the “Roasting chart” on page 32 for temperature recommendations.)



4. When baking, preheat oven. When roasting, start oven.

PRESS



Example:
YOU SEE



NOTE: After the temperature reaches 170°F, the red display will show the actual oven temperature at each 5°F increase and stop at the set temperature. **To see the set temperature before it is reached, press** the Bake pad. The set temperature will be displayed for 5 seconds.

5. When baking, put food in oven.

NOTE: If you want to change the baking temperature after baking has begun, repeat Steps 2, 3, and 4.

6. After cooking, turn off oven.

PRESS



Example:
YOU SEE
(time of day)

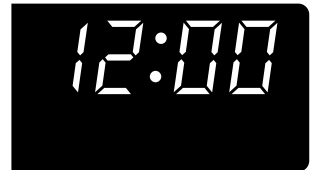



Adjusting oven temperature

Although your new oven is properly adjusted to provide accurate temperatures, it may cook faster or slower than your old oven.

If, after using the oven for a period of time, you are not satisfied with the baking/roasting results, you can change the offset temperature by following the steps below. The control will “remember” the selected offset even after the power has been interrupted or lost.

NOTE: Do not measure oven temperature with a thermometer. Opening the oven door will lower the oven temperature and give you an inaccurate reading. Also, the thermometer temperature reading will change as your oven cycles.

1. Choose Bake setting.

PRESS
and hold
for 4 seconds



Example:
YOU SEE



Release the Bake pad when a number appears in the temperature display and you hear a tone.

“0” (the setting shown) is set at the factory.

2. Set new offset temperature.

PRESS



Example:
YOU SEE

Adjustment 5°F cooler:



Each time you press the Bake pad, the displayed temperature will increase by 5°F. **To decrease the temperature, hold down** the Bake pad until the display goes past 35°F. At that point the display will return to 0 and will then decrease 5°F for every time you press the Bake pad. You can set the offset temperature adjustment as low as -35°F or as high as +35°F. (To determine the amount of adjustment needed, see the chart on page 21.)



3. Enter the adjustment.

PRESS



Example:
YOU SEE
(time of day)

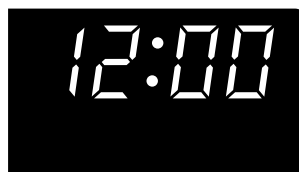

How to determine the amount of adjustment needed

The following chart tells you how much to adjust the offset temperature to get the desired cooking results. You can determine cooking results by amount of browning, moistness, and rising times for baked foods.

TO COOK FOOD ...	ADJUST BY THIS NUMBER OF DEGREES
A little more	+5 to +10
Moderately more	+15 to +20
Much more	+25 to +35
A little less	-5 to -10
Moderately less	-15 to -20
Much less	-25 to -35



Using and Caring for Your Oven

Broiling

NOTE: Preheating is not necessary when broiling.

1. Position rack.

See the “Broiling chart” on page 24 for recommended rack positions.

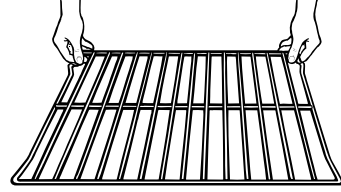

2. Put food in oven.

Place food on grid in broiler pan and place in center of the oven rack.

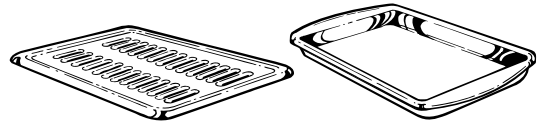

Broiler grid

Broiler pan

3. Position door.

Close the door to the Broil Stop position (open about 4 inches [10 cm]). The door will stay open by itself.

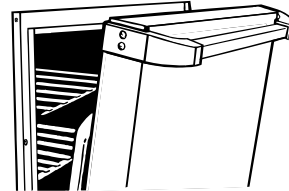

4. Choose broil setting.

PRESS



YOU SEE

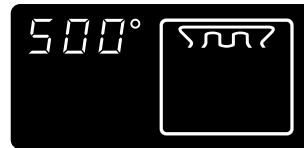

5. Set temperature (optional).

Do this step if you want to use variable temperature broiling (see page 23).

Example:
YOU SEE



Example:
YOU SEE



(See the “Broiling chart” on page 24 for temperature recommendations.)



6. Start oven.

PRESS



Example:
YOU SEE



NOTE: Leave the door partly open whenever using the oven to broil. This allows the oven to maintain proper temperatures. If you want to change the broiling temperature after broiling has begun, repeat Steps 4, 5, and 6.

7. When broiling is done, turn off oven.

PRESS



Example:
YOU SEE
(time of day)

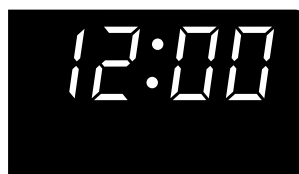

Variable temperature broiling

- **If food is cooking** too fast or you want the food to broil slower from the start, set the broil temperature between 170°F and 325°F (77°C and 163°C). These temperature settings allow the broil heating element to cycle and to slow cooking. The lower the temperature, the slower the cooking.
- **Fish and chicken** are some foods that may cook better if you use lower broiling temperatures. (See the “Broiling chart” on page 24 for temperature recommendations.)



Using and Caring for Your Oven

Broiling tips

- **Always start** broiling with a cold broiler pan for even results.
- **To retain more natural juice**, do not pierce meat with a fork.
- **Trim** the outer layer of fat from steaks and chops.
- **Slit** fatty edges to prevent meat from curling during broiling.
- **Use a nonstick cooking spray or vegetable oil** on the broiler pan and grid when broiling fish to prevent sticking.

Broiling chart

– Press the Broil pad.

– The recommended rack position is numbered lowest (1) to highest (5).

MEAT	RACK POSITION	TEMPERATURE	APPROXIMATE TOTAL TIME (MINUTES)
Steak, 1" thick	4	500°F	
• rare			16
• medium			21
• well-done			25
Steak, 1½" thick	4	500°F	
• rare			23
• medium			28
Hamburger patties or steaks, ½" thick or less			
• medium	5	500°F	8-12
Lamb chops, 1" thick	4	400°F	18-20
Ham slice, ½" thick	4	500°F	10-12
1" thick	4	500°F	20-22
Pork chops, 1" thick	4	450°F	25-28
Frankfurters	4	500°F	8
Chicken pieces	3	500°F	32
Fish, ½" thick	3	350°F	20
1" thick	3	350°F	20-22
Calves liver, ½" thick	4	350°F	10-12

Temperatures and times are guidelines only and may need to be adjusted to individual tastes.



Timed cooking

The electronic clock/oven control will turn the oven on and off at times you set, even when you are not around.

Delayed time cooking is ideal for foods which do not require a preheated oven, such as meats and casseroles. **Do not use delayed time cooking for cakes, cookies, etc. – they will not rise properly. Before using timed cooking, make sure the clock is set to the correct time of day.** (See “Setting the clock” on page 16.)

To start baking/roasting now and stop automatically:

1. Prepare oven.

Position the oven rack(s) properly and place the food in the oven. For correct rack placement, see “Rack positions” on page 28 and “Rack placement” chart on page 29.

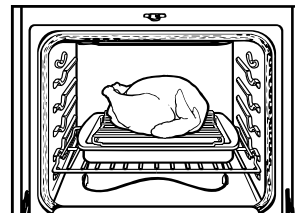

! WARNING

Food Poisoning Hazard

Do not let food sit in oven more than one hour before or after cooking.

Doing so can result in death, food poisoning, or sickness.

2. Choose setting.

PRESS

BAKE

YOU SEE

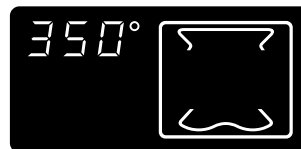

3. Set temperature (optional).

Do this step if you want to set a temperature other than 350°F.

Example:

PRESS

3

7

5

Example:

YOU SEE



(See the “Baking chart” on page 30 or the “Roasting chart” on page 32 for temperature recommendations.)



Using and Caring for Your Oven

4. Set stop time.

PRESS



Example:
YOU SEE
(time of day)



Example:
PRESS



Example:
YOU SEE



5. Start oven.

PRESS



When baking/roasting is done, “End” and the time of day will show in the display. Four tones will sound, followed by one short tone every minute, until you open the door or press the Cancel/Off pad.

Example:
YOU SEE
(time of day)



To delay start and stop automatically:

1. Prepare oven.

Position the oven rack(s) properly and place the food in the oven. For correct rack placement, see “Rack positions” on page 28 and “Rack placement” chart on page 29.

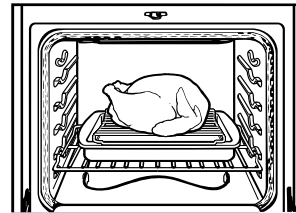

2. Choose setting.

PRESS



YOU SEE

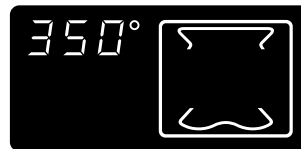

continued on next page



3. Set temperature (optional).

Do this step if you want to set a temperature other than 350°F.

Example:
PRESS



Example:
YOU SEE



(See the “Baking chart” on page 30 or the “Roasting chart” on page 32 for temperature recommendations.)

4. Set start time.

PRESS



Example:
YOU SEE
(time of day)



Example:
PRESS



Example:
YOU SEE



5. Set stop time.

PRESS



Example:
YOU SEE
(time of day)



Example:
PRESS



Example:
YOU SEE



6. Complete entry.

PRESS



Example:
YOU SEE
(time of day)



When start time is reached:

Example:
YOU SEE





Using and Caring for Your Oven

When baking/roasting is done, “End” and the time of day will show in the display. Four tones will sound, followed by one short tone every minute, until you open the door or press the Cancel/Off pad.

Example:
YOU SEE
(time of day)



To cancel timed cooking settings:

PRESS



Example:
YOU SEE
(time of day)

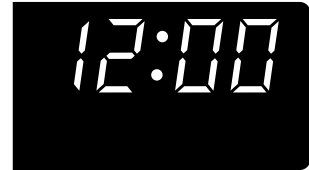

Cooking tips

Baking tips

The hot air must circulate around the pans in the oven for even heat to reach all parts of the oven. This results in better baking.

For best air circulation:

- Place the pans so that one is not directly over the other.



- For best results, allow 1½ to 2 inches of space around each pan and between pans and oven walls.
- When baking with one pan, place pan in the center of the oven rack.

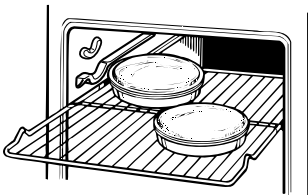

- When baking with two pans, place pans in opposite corners of the oven rack.

NOTE: “Oven peeking” may cause heat loss, longer cooking times, and unsatisfactory baking or roasting results. Rely on your timer.

Rack positions

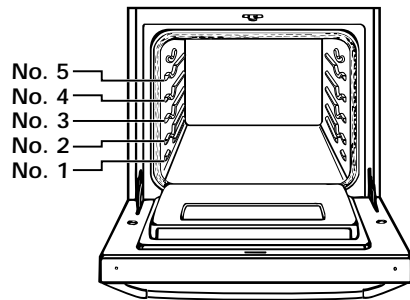

Your oven has two straight racks and five rack positions. Rack position 5 is the highest position, or farthest from the bottom of the oven. Rack position 1 is the lowest position, or closest to the bottom of the oven.

For proper cooking, follow these guidelines:

- When using one rack, place the rack so the top of the food will be centered in the oven.
- When using two racks, place one rack in position 1 and the other rack in position 3.
- Use only one cookie sheet in the oven at a time when using the Bake setting.



Bakeware tips

- **When baking with insulated cookie sheets or baking pans**, place them in the bottom third of the oven. You may need to increase the recommended baking times, so test for doneness before removing from the oven.
- **When using ovenproof glassware or dark bakeware**, reduce the oven temperature by 25°F, but use the same baking time. Because these pans absorb heat, producing darker bottom browning and crispier crusts, place the rack in the center of the oven. When baking pies and bread, you can use the temperature suggested in the recipe.

Rack placement for specific foods:

(For rack positions, see “Rack positions” on page 28.)

FOOD	RACK POSITION
Frozen pies	2
Angel food and bundt cakes, most quick breads, yeast breads, casseroles, meats	1 or 2
Cookies, biscuits, muffins, cakes, nonfrozen pies	2 or 3

Using aluminum foil in the oven

Use aluminum foil to catch spillovers from pies or casseroles.

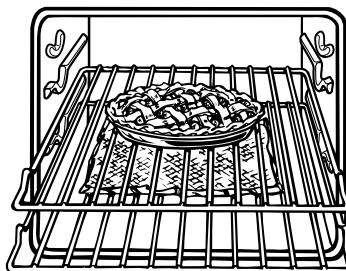

- **Place** the foil on the oven rack below the rack with the food. Turn foil edges up and make sure foil is about 1 inch (3 cm) larger all around than the dish holding the food.
- **Do not cover** the entire rack with aluminum foil. It will reduce air circulation and cause poor cooking results.
- **Do not line** oven bottom or entire oven rack with foil or other liners. It could affect the quality of your baking.



Baking chart

FOOD	OVEN TEMPERATURE	APPROXIMATE COOKING TIME (MINUTES)
Breads, yeast		
• loaf	375°F	30-40
• rolls, pan	400°F	12-15
Breads, quick		
• biscuits	450°F	10-15
• muffins	400°F	20-25
• popovers	450°F	20-25
• corn bread	425°F	25-30
• nut bread	350°F	60-75
• gingerbread	350°F	25-30
Cakes		
• angel food	375°F	30-40
• layer cake	350-375°F	20-30
• loaf cake	350°F	35-45
• sponge cake	350°F	35-45
• pound cake	350°F	34-45
• fruit cake	300°F	2-2½ hrs
• sheet cake	300°F	25-35
Cookies		
• drop	375°F	10-15
• rolled and refrigerated	375°F	12-18
• chocolate	375°F	10-15
• fruit and molasses	375°F	10-15
• brownies	350°F	20-30
• macaroons	350°F	12-15
Miscellaneous		
• apples, baked	375°F	50-60
• beans, baked	300°F	5-6 hrs
• custard, cup	325°F	35-40
• potatoes, baked	400°F	75
• pudding		
bread	350°F	45-60
cottage	375°F	30-40
rice	325°F	40-60
• scalloped dishes	350°F	60-90
• soufflé	350°F	50-60
Pastries		
• cream puffs	400°F	35-40
• custard and pumpkin pie	350°F	30-40
• pastry shell	450°F	10-12
• two crust fruit pie		
cooked filling	400°F	25-30
uncooked filling	400°F	40-50
• meringue topping	350°F	10-15

Temperatures and times are guidelines only and may need to be adjusted to individual tastes.



Roasting tips

- **Roast** meats fat-side up in a shallow pan using a roasting rack.
- **Use a roasting pan** that fits the size of the food to be roasted. Meat juices may overflow the sides of a pan that is too small. Too large of a pan will result in increased oven spatter.
- **Spatter can be reduced** by lining the bottom of the roasting pan with lightly crushed aluminum foil.

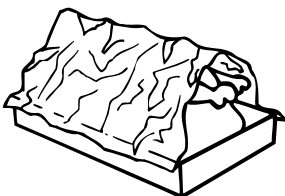

- **A foil tent** will slow down surface browning for long-term roasting, as when roasting a turkey. Place tent-shaped foil loosely over meat to allow for air circulation. Do not seal foil or meat will be steamed.

- **Use an accurate meat thermometer** to determine when meat has reached desired degree of doneness. Insert the thermometer into the center of the thickest portion of the meat or inner thigh or breast of poultry. For an accurate reading, the tip of the thermometer should not touch fat, bone, or gristle.
- **After reading the thermometer once**, push it further into the meat ½ inch or more and read again. If the temperature drops, return the meat to the oven for more cooking.
- **Check pork and poultry** with a thermometer in 2-3 places to ensure adequate doneness.
- **Poultry and roasts will be easier to carve** if loosely covered with foil and allowed to stand 10-15 minutes after removal from the oven.



Roasting chart

- Roast at oven temperature of 325°F.*
Preheating is not needed.
- Place roasting pan on rack position 1 or 2.

MEAT	APPROXIMATE WEIGHT	APPROXIMATE MINUTES PER POUND	MEAT THERMOMETER TEMPERATURE
Beef			
rolled rib	3-5 lbs		
• rare		25-29	140°F
• medium		35-37	160°F
• well-done		45-47	170°F
standing rib	6-7 lbs		
• rare		23-25	140°F
• medium		30-32	160°F
• well-done		35-40	170°F
rump roast	4-6 lbs		
• medium		25-30	160°F
• well-done		35-37	170°F
Lamb			
leg	6-7 lbs		
• rare		18-20	140°F
• medium		21-24	150-155°F
• well-done		30-32	180°F
Pork			
loin	3-4 lbs	45-48	170°F
	5-6 lbs	28-30	170°F
shoulder	4-5 lbs	40-44	185°F
ham,	3-5 lbs	17-18	130°F
fully cooked	8-10 lbs	13-14	130°F
Poultry			
chicken*	3-4 lbs	28-30	185°F**
turkey,	10-16 lbs	14-19	170-180°F
unstuffed	18-25 lbs	11-15	170-180°F
Veal			
loin	3-4 lbs	35-38	170°F
shoulder	5-6 lbs	43-45	170°F

* For chicken, set the oven temperature to 350°F.

** The muscles may not be large enough to use a thermometer.



Cleaning your oven and controls

	⚠ WARNING
	<p>Explosion Hazard</p> <p>Do not store flammable materials such as gasoline near this appliance.</p> <p>Doing so can result in death, explosion, fire, or burns.</p>

PART	WHAT TO USE	HOW TO CLEAN
Control knobs	Sponge and warm, soapy water	<ul style="list-style-type: none"> • Turn knobs to OFF and pull straight away from control panel. • Wash, rinse, and dry thoroughly. Do not soak. • Do not use steel wool or abrasive cleansers. They may damage the finish of the knobs. • Replace knobs. Make sure all knobs point to OFF.
Control panel	Sponge and warm, soapy water OR Paper towel and spray glass cleaner	<ul style="list-style-type: none"> • Wash, wipe with clean water, and dry thoroughly. • Do not use steel wool or abrasive cleansers. They may damage the finish. • Do not spray cleaner directly on panel. Apply cleaner to paper towel. <p>NOTE: Make sure you have not turned the oven on when cleaning panel. If you have, press the Cancel/Off pad.</p>
Exterior surfaces (other than control panel)	Sponge and warm, soapy water	<ul style="list-style-type: none"> • Wash, wipe with clean water, and dry thoroughly. • Use nonabrasive, plastic scrubbing pad on heavily soiled areas. • Do not use abrasive or harsh cleansers. They may damage the finish.
Broiler pan and grid (clean after each use)	Steel-wool pad and warm, soapy water	<ul style="list-style-type: none"> • Wash, rinse, and dry thoroughly. • Do not clean the pan and grid in the Self-Cleaning cycle.

continued on next page



Using and Caring for Your Oven

PART	WHAT TO USE	HOW TO CLEAN
Oven racks	Steel-wool pad and warm, soapy water OR The Self-Cleaning cycle	<ul style="list-style-type: none">• Wash, rinse, and dry thoroughly. OR <ul style="list-style-type: none">• Leave in oven during Self-Cleaning cycle. NOTE: Racks will permanently discolor and become harder to slide if left in oven during the Self-Cleaning cycle. Apply a small amount of vegetable oil to the side rungs to aid sliding.
Oven door glass	Paper towel and spray glass cleaner OR Warm, soapy water and a nonabrasive, plastic scrubbing pad	<ul style="list-style-type: none">• Make sure oven is cool.• Follow directions provided with the cleaner.• Wash, wipe with clean water, and dry thoroughly.
Oven cavity	Self-Cleaning cycle	<ul style="list-style-type: none">• Wipe up food spills containing sugar as soon as possible after the oven cools down. (See “Using the Self-Cleaning Cycle” on page 36.)• See “Using the Self-Cleaning Cycle” on pages 36-39.



Using and replacing the oven light(s)

Your oven may have a standard oven light or two side halogen lights. The oven light(s) will come on when you open the oven door. To turn the light(s) on when the oven door is closed, **press** the Oven Light pad on the control panel. **Press** the pad again to turn off the light(s).

Replacing the oven light (models with light on back wall):

1. **Disconnect** appliance at main power supply. Make sure the oven is cool before replacing the light bulb.

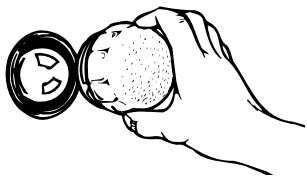

2. **Remove** the glass bulb cover in the back of the oven by screwing it out counter-clockwise.
3. **Remove** the light bulb from its socket. **Replace** the bulb with a 40-watt appliance bulb.
4. **Replace** the bulb cover by screwing it in clockwise. **Reconnect** appliance at main power supply.

NOTE: The oven light will not work during the Self-Cleaning cycle.

Replacing oven lights (models with side halogen lights):

1. **Disconnect** appliance at the main power supply. Make sure the oven is cool before replacing the light bulb.

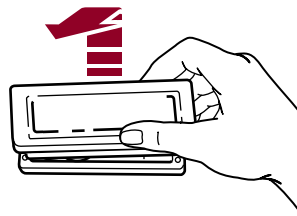

2. **Remove** glass light cover by grasping front edge of cover and pulling it away from the side wall of the oven.
3. **Remove** the light bulb from its socket. **Replace** the bulb with another halogen bulb (12 volt, 5 watt maximum, available at most hardware stores).
4. **Replace** the light cover by snapping it back into wall. **Reconnect** appliance at main power supply.

NOTE: The oven lights will not work during the Self-Cleaning cycle.

Using the Self-Cleaning Cycle

The Self-Cleaning cycle saves you from the toil and mess that often come with hand-cleaning the oven interior. Like the other functions of your oven, you operate the Self-Cleaning cycle with the easy-to-use electronic control. To use this cycle properly, follow the step-by-step instructions in this section.



!WARNING

Burn Hazard

Do not touch the oven during the Self-Cleaning cycle.
Keep children away from oven during Self-Cleaning cycle.
Do not use commercial oven cleaners in your oven.
Failure to follow these instructions can result in burns, or illness from inhaling dangerous fumes.

Before you start

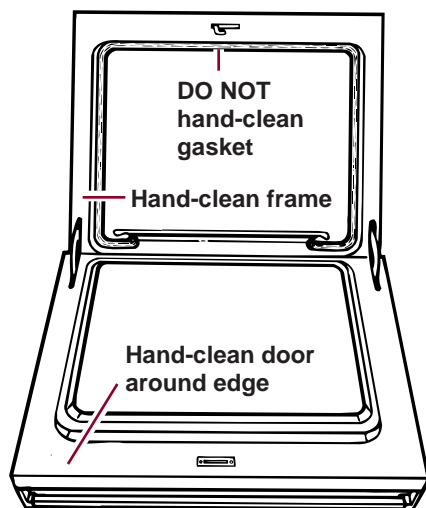

Before you start the Self-Cleaning cycle, make sure you:

- **Hand-clean the areas shown.** They do not get hot enough during the Self-Cleaning cycle for soil to burn away. Use hot water and detergent or a soapy steel-wool pad for cleaning.

NOTE: DO NOT clean, move, or bend the gasket. Poor cleaning, baking and roasting may result.

- **Remove** the broiler pan and grid and anything else being stored in the oven.
- **Wipe out** any loose soil or grease. This will help reduce smoke during the Self-Cleaning cycle.

- **Wipe up** food spills containing sugar as soon as possible after the oven cools down. When sugar is heated to a high temperature in the Self-Cleaning cycle, the high temperature can cause the sugar to burn and react with the porcelain. This can cause staining and etching or pitting.
- **Remove** the oven racks from the oven if you want them to remain shiny. You can clean racks in the Self-Cleaning cycle, but they will discolor and become harder to slide. If you clean racks in the Self-Cleaning cycle, place them on the rack guides.
- **Heat and odors** are normal during the Self-Cleaning cycle. Keep the kitchen well ventilated by opening a window or by turning on a vent hood or other kitchen vent during the cycle.

NOTES:

- **Do not block** the vent during the Self-Cleaning cycle. Air must move freely for best cleaning results.
- **Do not leave** plastic utensils on the cooktop. They may melt.
- **Do not leave** any foil in oven during the Self-Cleaning cycle. Foil could burn or melt and damage the oven surface.
- **The oven lights** will not work during the Self-Cleaning cycle.



Setting the controls

Make sure clock is set to correct time of day.

(See "Setting the clock" on page 16.)

To start cleaning immediately:

1. Choose clean setting.

PRESS



YOU SEE



A 3-hour Self-Cleaning cycle will be set.

NOTE: You cannot open the door when LOCKED is on.

2. Set clean time (optional).

If you want a Self-Cleaning cycle other than 3 hours, **press** the desired number pads for the new time up to 4 hours.

Example:
PRESS



Example:
YOU SEE



- Use 2 hours for light soil.
- Use 3-4 hours for moderate to heavy soil.

3. Start oven.

PRESS



Example:
YOU SEE



NOTE: If you want to change the cleaning time after cleaning has begun, repeat Steps 1-3.

To delay clean using start time:

1. Choose clean setting.

PRESS



YOU SEE



A 3-hour Self-Cleaning cycle will be set.

NOTE: You cannot open the door when LOCKED is on.

continued on next page



Using the Self-Cleaning Cycle

2. Set clean time (optional).

If you want a Self-Cleaning cycle other than 3 hours, **press** the desired number pads for the new time up to 4 hours.

Example:
PRESS



- Use 2 hours for light soil.
- Use 3-4 hours for moderate to heavy soil.

Example:
YOU SEE



3. Set start time.

PRESS



Example:
PRESS



Example:
YOU SEE
(time of day)



Example:
YOU SEE



4. Complete entry.

PRESS



Example:
YOU SEE



NOTE: If you want to change the cleaning time after cleaning has begun, repeat Steps 1-4.

Example:
YOU SEE



After the Self-Cleaning cycle is completed:

Example:
YOU SEE
(time of day)

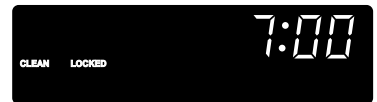

When the oven cools to normal baking/roasting temperatures:

Example:
YOU SEE
(time of day)



To stop the Self-Cleaning cycle at any time:

PRESS



Example:
YOU SEE
(time of day)

When the oven cools to normal baking/roasting temperature:



For best cleaning results

- After the oven cools to room temperature, wipe up any residue or ash with a damp cloth or sponge. If any spots remain, clean with a mild abrasive cleanser or cleaning sponge.
- Clean the oven before it gets heavily soiled. Cleaning a very soiled oven takes longer and results in more smoke than usual.
- If the Self-Cleaning cycle does not get the oven as clean as you expected, the cycle may not have been set long enough or you may not have prepared the oven properly. Set the Self-Cleaning cycle longer the next time and hand-clean areas noted on page 36.

How the cycle works

The Self-Cleaning cycle uses very high heat to burn away soil and grease. During the cycle, the oven gets much hotter than it does for normal baking or broiling. This high heat breaks up the soil or grease and burns it away.

Your oven is preset for a 3-hour Self-Cleaning cycle. However, the cycle time can be adjusted to the amount of soil in your oven. The cycle can be set anywhere between 2 and 4 hours. (See “Setting the controls” on page 37.)

The graph at the right is representative of a normal, 3-hour Self-Cleaning cycle. Note that the heating stops when the 3-hour setting is up, but it takes longer for the oven to cool enough to unlock.

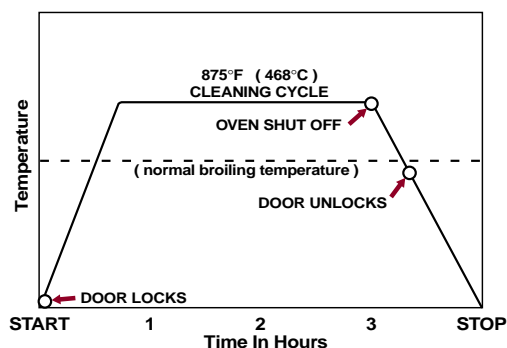

If You Need Assistance or Service

Questions or comments? Call our toll-free Consumer Assistance Center telephone number, 1-800-422-1230.

This section is designed to help you save the cost of a service call. Part 1 of this section outlines possible problems, their causes, and actions you can take to solve each problem. Parts 2 and 3 tell you what to do if you still need assistance or service. When calling our Consumer Assistance Center for help or calling for service, please provide a detailed description of the problem, your appliance's complete model and serial numbers, and the purchase or installation date. (See page 2.) This information will help us respond properly to your request.

1. Before calling for service:

If your appliance should fail to operate, review the following list before calling your dealer. You could save the cost of a service call.

PROBLEM	POSSIBLE CAUSE	WHAT TO DO
Nothing will operate	The unit is not wired into a live circuit with proper voltage.	Wire the unit into a live circuit with proper voltage. (See Installation Instructions.)
	A household fuse has blown or a circuit breaker has tripped.	Replace household fuse or reset circuit breaker.
The oven will not operate	You have not set the electronic control correctly.	Refer to the section in this manual describing the function you are operating.
	You have programmed a delayed start time.	Wait for the start time to be reached or cancel and reset the controls.
The surface units will not operate	A household fuse has blown or a circuit breaker has tripped.	Replace household fuse or reset circuit breaker.
	You have not plugged in surface units all the way.	Turn control knobs to OFF and plug surface units in all the way. (See "Replacing" on page 12.)
	You have not set the control knobs correctly.	Push control knobs in before turning to a setting.
The control knob(s) will not turn	You are not pushing in before turning.	Push control knob(s) in before turning to a setting.



PROBLEM	POSSIBLE CAUSE	WHAT TO DO
The Self-Cleaning cycle will not operate	You have programmed a delayed start time.	Wait for the start time to be reached or cancel and reset the controls.
Cooking results are not what you expected	<p>The range is not level.</p> <p>The oven temperature seems too low or too high.</p> <p>You did not preheat the oven before baking.</p> <p>The recipe you are using may need to be altered to improve the taste or appearance of the food.</p> <p>The pan used is not the correct type or size.</p> <p>There is not proper air circulation around pan when baking.</p> <p>Cookware does not fit the surface unit being used.</p>	<p>Level range. (See Installation Instructions.)</p> <p>Adjust the oven temperature. (See “Adjusting oven temperature” on page 20.)</p> <p>Preheat oven when called for in recipe.</p> <p>Alter recipe as needed.</p> <p>Refer to a reliable cookbook or recipe for recommended pan type and size.</p> <p>Allow 1½ to 2 inches (4-5 cm) of air space on all sides of pan.</p> <p>Pan should be the same size or slightly larger than surface unit being used.</p>
The display is flashing “88:88”	There has been a power failure.	Reset the clock. (See page 16.)
“F-” followed by a number shows in the display		Call for service. (See Step 3 on page 42.)

continued on next page



If You Need Assistance or Service

2. If the problem is not due to one of the items listed in Step 1:

- Call KitchenAid Consumer Assistance Center:



1-800-422-1230

One of our trained consultants can instruct you in how to

obtain satisfactory operation from your appliance or, if service is necessary, recommend a qualified service company in your area.

- If you prefer, write to:

KitchenAid Brand Home Appliances
Consumer Assistance Center
c/o Correspondence Dept.
2000 North M-63
Benton Harbor, MI 49022-2692

Please include a daytime phone number in your correspondence.

3. If you need service*:

- Call your dealer or the repair service he recommends.



• All service should be handled locally by the dealer from whom you purchased the unit or an authorized KitchenAid servicer.

- If you are unable to obtain the name of a local authorized KitchenAid servicer, call our Consumer Assistance Center telephone number (see Step 2).

4. If you are not satisfied with the action taken:

- Contact the Major Appliance Consumer Action Program (MACAP). MACAP is a group of independent consumer experts that voices consumer views at the highest levels of the major appliance industry.
- Contact MACAP only when the dealer, authorized servicer, and KitchenAid have failed to resolve your problem.

Major Appliance Consumer Action Program
20 North Wacker Drive
Chicago, IL 60606

- MACAP will in turn inform us of your action.

* When asking for help or service:

Please provide a detailed description of the problem, your appliance's complete model and serial numbers, and the purchase date. (See page 2.) This information will help us respond properly to your request.

Don't forget, KitchenAid offers a full line of quality home appliances.

Built-In Refrigerators

Trash Compactors

Ranges & Cooktops

Freestanding Refrigerators

Hot Water Dispensers

Microwave Ovens

50-Pound Ice Makers

Food Waste Disposers

Washers & Dryers

Dishwashers

Built-In Ovens

Mixers & Blenders

For more information on these appliances, or the one you have purchased, call our toll-free Consumer Assistance Center telephone number, **1-800-422-1230**.

KitchenAid®

Electric Range

Warranty

LENGTH OF WARRANTY:	KITCHENAID WILL PAY FOR:	KITCHENAID WILL NOT PAY FOR:
ONE-YEAR FULL WARRANTY FROM DATE OF PURCHASE.	Replacement parts and repair labor costs to correct defects in materials or workmanship. Service must be provided by an authorized KitchenAid servicing outlet.	A. Service calls to: <ol style="list-style-type: none"> 1. Correct the installation of the range. 2. Instruct you how to use the range. 3. Replace house fuses or correct house wiring. B. Repairs when range is used in other than normal home use. C. Damage resulting from accident, alteration, misuse, abuse, improper installation, or installation not in accordance with local electrical codes. D. Any labor costs during the limited warranties. E. Replacement parts or repair labor costs for units operated outside the United States. F. Pickup and delivery. This product is designed to be repaired in the home. G. Repairs to parts or systems caused by unauthorized modifications made to the appliance.
SECOND-THROUGH FIFTH-YEAR LIMITED WARRANTY FROM DATE OF PURCHASE.	Replacement parts for any electric element to correct defects in materials or workmanship. Replacement parts for solid state touch control system to correct defects in materials or workmanship.	
SECOND-THROUGH TENTH-YEAR LIMITED WARRANTY FROM DATE OF PURCHASE.	Replacement parts for the porcelain oven cavity/inner door if the part rusts through due to defects in materials or workmanship.	

7/95

KITCHENAID DOES NOT ASSUME ANY RESPONSIBILITY FOR INCIDENTAL OR CONSEQUENTIAL DAMAGES. Some states do not allow the exclusion or limitation of incidental or consequential damages, so this exclusion or limitation may not apply to you. This warranty gives you specific legal rights, and you may also have other rights which vary from state to state.

Outside the United States, a different warranty may apply. For details, please contact your authorized KitchenAid dealer.

If you need service, first see the "If You Need Assistance or Service" section of this book. After checking "If You Need Assistance or Service," additional help can be found by calling our Consumer Assistance Center telephone number, **1-800-422-1230**, from anywhere in the U.S.A.

KitchenAid
Benton Harbor, Michigan 49022-2692