

**SHARP**®

# PN-S655

LCD MONITOR

OPERATION GUIDE

**HDMI**™  
HIGH-DEFINITION MULTIMEDIA INTERFACE

# Contents

<b>Basic Operation .....</b>	<b>3</b>
<b>Menu Items .....</b>	<b>5</b>
Displaying the menu screen .....	5
Menu item details .....	6
Adjustments for PC screen display .....	10
<b>Initialization (Reset)/Functional Restriction Setting... ..</b>	<b>11</b>
<b>Controlling the Monitor with a PC (RS-232C).....</b>	<b>12</b>
PC connection.....	12
Communication conditions .....	12
Communication procedure .....	12
RS-232C command table.....	16
<b>Controlling the Monitor with a PC (LAN) .....</b>	<b>21</b>
Settings to connect to a LAN.....	21
Controlling with a PC.....	23

This guide contains instructions regarding operation, settings, and similar details.  
For instructions regarding connection and installation, refer to the included Operation Manual.

## Manual Scope

- Microsoft, Windows and Internet Explorer are registered trademarks of Microsoft Corporation.
- HDMI, the HDMI Logo and High-Definition Multimedia Interface are trademarks or registered trademarks of HDMI Licensing LLC.
- Adobe, Acrobat, and Reader are either registered trademarks or trademarks of Adobe Systems Incorporated in the United States and/or other countries.
- This product comes with RICOH Bitmap Fonts produced and sold by RICOH COMPANY, LTD.
- All other brand and product names are trademarks or registered trademarks of their respective holders.
- Language of OSD menu used in this manual is English by way of example.
- Illustrations in this manual may not exactly represent the actual product or display.

# Basic Operation

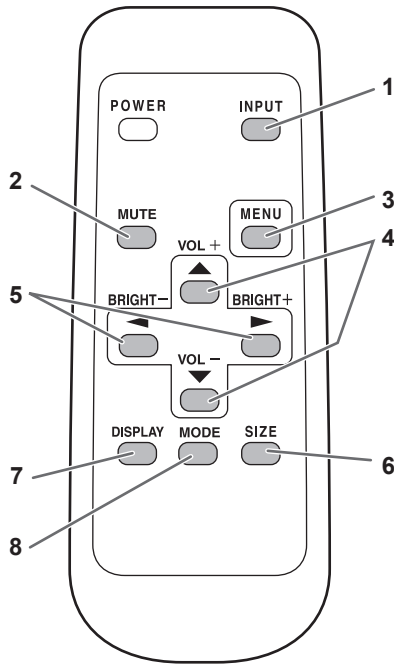

## 1. INPUT (Input mode selection)

The menu is displayed. Press or to select the input mode, and press to enter.  
\* You can select the input terminal by pressing the input switch of the monitor.

Input mode	Video	Audio
PC1 DVI-D <sup>*1</sup>	PC1 input terminal	PC audio input terminal
PC2 HDMI <sup>*2</sup>	PC2 input terminal	
PC3 D-SUB	PC3 input terminal	
PC4 RGB <sup>*3</sup>	PC4 input terminals	
AV1 DVI-D <sup>*1</sup>	AV1 input terminal	AV audio input terminals
AV2 HDMI <sup>*2</sup>	AV2 input terminal	
AV3 COMPONENT <sup>*3</sup>	AV3 input terminals	
AV4 S-VIDEO	AV4 input terminal	
AV5 VIDEO	AV5 input terminal	

- \*1 Select the terminal for DVI SELECT. (See page 7.)
- \*2 Select the terminal for HDMI SELECT. (See page 7.)  
Select the terminal for HDMI AUDIO SELECT which is used for audio input. (See page 7.)
- \*3 Select the terminal for BNC SELECT. (See page 7.)

## 2. MUTE

Turns off the volume temporarily.  
Press the MUTE button again to turn the sound back to the previous level.

## 3. MENU

Displays and turns off the menu screen (see page 5).

## 4. VOL +/- (Volume adjustment)

Pressing or displays the VOLUME menu when the menu screen is not displayed.



Press or to adjust the volume of the sound.  
\* If you do not press any buttons for about 4 seconds, the VOLUME menu automatically disappears.

## 5. BRIGHT +/- (Backlight adjustment)

Pressing or displays the BRIGHT menu when the menu screen is not displayed.



Press or to adjust the brightness.  
\* If you do not press any buttons for about 4 seconds, the BRIGHT menu automatically disappears.

## 6. SIZE (Screen size selection)

The menu is displayed.  
Press or to select the screen size. (See page 4.)

## 7. DISPLAY

Displays monitor information. Every time you press this button, the display changes from INFORMATION 1 → INFORMATION 2 → display clear and so on.

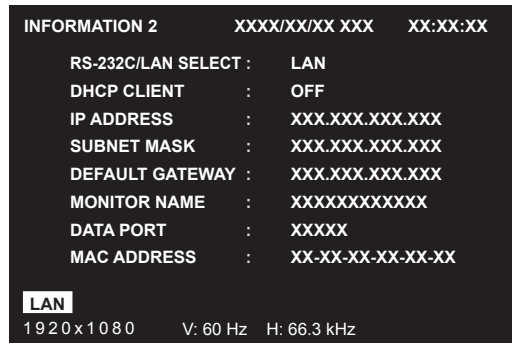
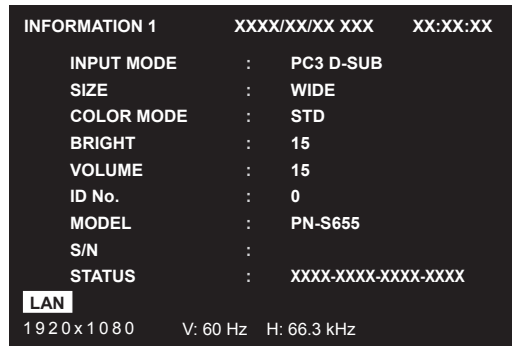

- The display disappears automatically after about 15 seconds.
- **LAN** is displayed during LAN communication.

## 8. MODE (Color mode selection)

Each time you press this button, the color mode changes in the following order:

STD (Standard) → VIVID → sRGB → STD...

- sRGB applies to PC input only.  
sRGB is international standard of color representation specified by IEC (International Electrotechnical Commission). Color conversion is made in taking account of liquid crystal's characteristics and represents color tone close to its original image.

## Basic Operation

### ■Switching the screen size

Even when the screen size is changed, the display may remain the same depending on the input signal.

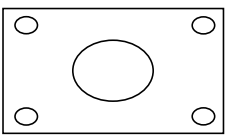
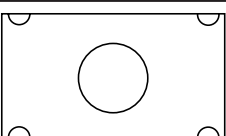
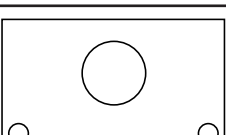
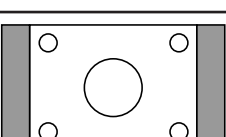
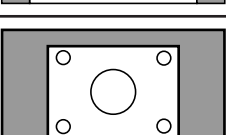
<b>WIDE</b>		PC input	Displays image so it fills the entire screen.
		AV input	An image with a 4:3 aspect ratio is stretched to fill the entire screen.
<b>ZOOM 1</b>		PC input	An image with a 4:3 aspect ratio is enlarged to fill the entire screen without changing the aspect ratio. The edges of the image may be cut off.
		AV input	
<b>ZOOM 2</b>		PC input	Use this size if ZOOM 1 cuts off the subtitles.
		AV input	
<b>NORMAL</b>		PC input	Displays image so it fills the screen without changing the aspect ratio of the input signals.
		AV input	Displays the entire image of the aspect ratio of 4:3 without changing the aspect ratio.
<b>Dot by Dot</b>		PC input	Displays the dots of the signals input from the connected PC as the corresponding dots on the screen. *
		AV input	Displays the dots of the input signals as the corresponding dots on the screen.

\*: With a monitor of screen resolution 1600 x 1200 or 1920 x 1200, selecting Dot by Dot displays the NORMAL screen.

#### TIPS

- Using this monitor's screen-size switching or dual-screen display functions to compress or expand the screen for commercial or public viewing in establishments like cafes or hotels may infringe on the rights of the creators, as protected by Copyright Law, so please be careful.
- When "Enlarge" is set, the screen size is fixed to "WIDE" mode.
- When dual-screen display is selected, the screen size cannot be changed.
- The appearance of the original video may change if you select a screen size with a different aspect ratio than the original image (e.g. TV broadcast or video input from external equipment).
- When an ordinary non-wide image (4:3) is viewed with the whole screen using the screen-size switching function of this monitor, the edge of the image may be lost or appear distorted. If you wish to respect the creator's intentions, set the screen size to "NORMAL".
- When playing commercial software, parts of the image (like subtitles) may be cropped. In this case select the optimal screen size using the screen-size switching function of this monitor. With some software, there may be noise or distortion at the edges of the screen. This is due to the characteristics of the software, and is not a malfunction.
- Depending on the original image size, black bands may remain at the edges of the screen.

# Menu Items

## Displaying the menu screen

Video and audio adjustment and settings of various functions are enabled. This section describes how to use the menu items. See pages 6 to 8 for details of each menu items.

### Example of operation

(Adjusting CONTRAST in the PICTURE menu)

1. Press to display the menu screen.

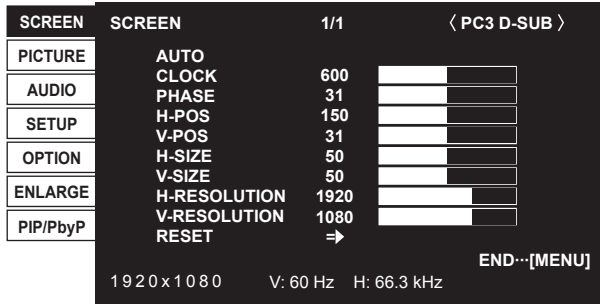

2. Press or to select PICTURE, and press . PICTURE menu is displayed.

3. Press or to select CONTRAST.

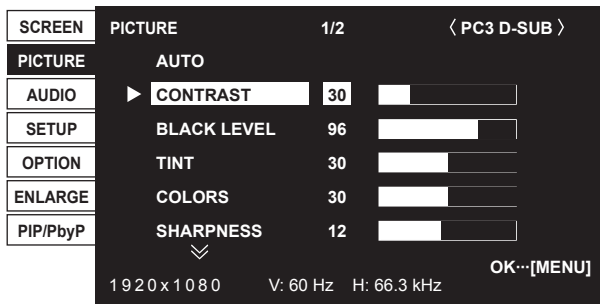

4. Press or to adjust the setting.

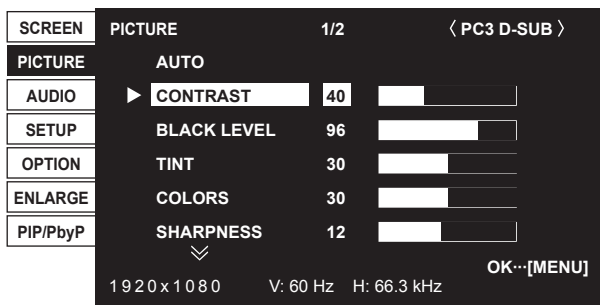

For items that have , press , make settings and then press .

5. Press twice to close the menu screen.

#### TIPS

- The menu will differ depending on the input mode.
- The menu screen will close automatically if no operation is performed for about 15 seconds. (DATE/TIME SETTING, SCHEDULE and LAN SETUP screens will close in about 4 minutes.)

## Menu screen display

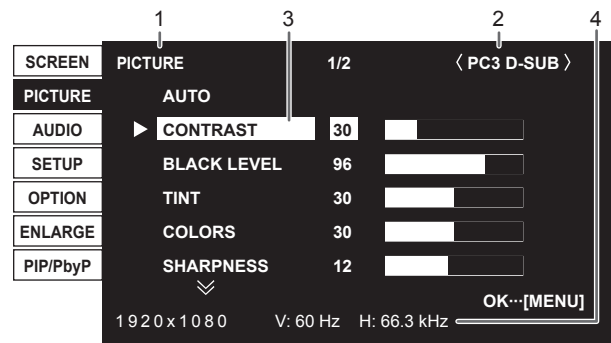

- Name of the menu
- Input mode
- An item being selected (highlighted)
- Screen resolution of input signal, and other data.

#### TIPS

- Items that cannot be selected appear in gray. (e.g. Function not supported by the current input signal)

## Menu Items

### Menu item details

The menu will differ depending on the input mode.

#### ■ SCREEN

##### AUTO (PC3/PC4)

The CLOCK, PHASE, H-POS, and V-POS are automatically adjusted.

Pressing  performs adjustment.

Use this automatic adjustment when you use the PC3 input terminal or PC4 input terminals to display a PC screen for the first time or when you change the setting of the PC. (See page 10.)

##### CLOCK (PC3/PC4)

Adjusts frequency for sampling clock for applicable video. Adjust when there is flickering in the form of vertical stripes. When using the adjustment pattern (see page 10), make adjustments so that no vertical stripe noise appears in it.

##### PHASE (PC3/PC4)

Adjusts sampling clock phase for applicable video. Useful when small characters appear with low contrast and/or there are flickers at corners. When using the adjustment pattern (see page 10), make adjustments so that no horizontal stripe noise appears in it.  
\* Adjustments to PHASE should be made only after CLOCK has been correctly set.

##### H-POS

Adjust the horizontal position of the image.

##### V-POS

Adjust the vertical position of the image.

##### H-SIZE

Adjust the horizontal size of the image.

##### V-SIZE

Adjust the vertical size of the image.

##### H-RESOLUTION (PC3/PC4)

Sets proper horizontal resolution when the resolution of input signals is not recognized properly. (Adjustment may be impossible with some signals.)

##### V-RESOLUTION (PC3/PC4)

Sets proper vertical resolution when the resolution of input signals is not recognized properly. (Adjustment may be impossible with some signals.)

##### RESET

Resets the values of the SCREEN menu items to the factory preset values.  
Select "ON" and then press .

#### ■ PICTURE

##### AUTO (PC3/PC4)

The CONTRAST and BLACK LEVEL are automatically adjusted.

Pressing  performs adjustment.

##### CONTRAST

Adjusts the brightness of the image.

##### BLACK LEVEL

Adjusts the entire brightness of the video signals.

##### TINT

Adjusts the hue. Selecting + changes the color towards green, and selecting - changes it towards magenta.

#### COLORS

Adjusts the color intensity.

#### SHARPNESS

Adjusts the sharpness of the image.

#### ADVANCED (AV input)

You can adjust more specifically. (See page 10.)

#### COLOR MODE

Changes the color mode on the screen. The color mode on the screen can also be changed using a remote control unit. (See page 3.)

\* sRGB is PC input only. See page 3 for details.

#### WHITE BALANCE

THRU..... Displays the input signal level as is. (for PC1/PC2 only)

PRESET ..... Selects the color temperature using PRESET.

USER..... Used for adjusting R-CONTRAST, G-CONTRAST, and B-CONTRAST respectively.

#### PRESET

Selects the color temperature when the WHITE BALANCE is set to PRESET.

The setting values are shown for reference. The color temperature of the screen varies over time.

This function is not intended to keep the color temperature constant.

#### R-CONTRAST

Adjusts red component when the WHITE BALANCE is set to USER.

#### G-CONTRAST

Adjusts green component when the WHITE BALANCE is set to USER.

#### B-CONTRAST

Adjusts blue component when the WHITE BALANCE is set to USER.

#### COPY TO USER

Copies the value set for PRESET to the USER setting.  
Select "ON" and then press .

#### GAMMA

Select a gamma value.

#### RESET

Resets the values of the PICTURE menu items to the factory preset values.

Select "ON" and then press .

#### ■ AUDIO

##### TREBLE

Adjusts the volume of treble-level sound.

##### BASS

Adjusts the volume of bass-level sound.

##### BALANCE

Adjusts the balance of the audio sound between right and left.

##### RESET

Resets the values of the AUDIO menu items to the factory preset values.  
Select "ON" and then press .

**■SETUP****OSD H-POSITION**

Adjusts the horizontal display position of menu screen.

**OSD V-POSITION**

Adjusts the vertical display position of menu screen.

**LANGUAGE**

Sets the display language for the menu screen.

**HDMI AUTO VIEW**

When ON is selected, the screen size is adjusted automatically according to the screen size control signal included in the video signal input from the AV2 input terminal.

**PICTURE FLIP**

A picture flips to appear.

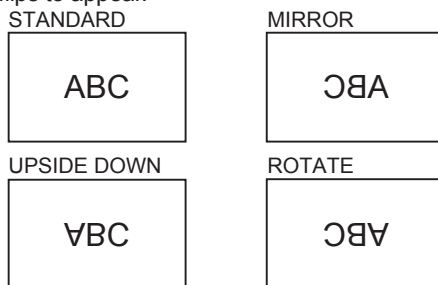
**POWER ON DELAY**

You can delay the screen display after the monitor is turned on. The period can be set up to 60 seconds in units of one second. When this function is activated, the power LED flashes (at approx. 1 second interval) in orange. This function is disabled when 0 is specified.

**STANDBY MODE**

When STANDARD is selected, startup time from standby mode is reduced. Note, however that, more power will be consumed in standby mode.

When LOW POWER is selected, current consumption is reduced while the monitor is in standby mode. Note, however, that the startup time from standby mode becomes longer. Also, certain RS-232C commands cannot be used in standby mode. (See page 16.)

**RS-232C/LAN SELECT**

Selects the method with which to control the monitor from the computer.

**RS-232C/LAN COMMAND**

Set the return value for the RS-232C command. Normally, you do not need to change this setting from NORMAL.

NORMAL ..... The end code of the return value is CR+LF.  
 MODE1 ..... The end code of the return value is CR only.  
 MODE2 ..... The length of the return value is fixed to 4 digits. The end code is CR only.  
 When the return value has 1 to 3 digits, the empty digit(s) from the left is filled with a one-byte space(s).

**ID No. SET**

Assigns ID numbers to monitors connected in a daisy chain (see page 13), using RS-232 cables.





The numbers 1 to 255 are available for ID numbers.

If "0" is set, the system regards this as the state where no ID number is set.

**LAN SETUP**

Configures the settings to control the monitor from the computer via LAN. (See page 21.)

**■OPTION****DATE/TIME SETTING**

Set the date and time. Press  or  to select the date and time, and press  or  to change the numerical values.

Set the date in "Year/Month/Day" order.

Set the time on a 24-hour basis.

**SCHEDULE (See page 9.)**

You can set the time to switch the monitor on and off.

**INPUT SELECT**

DVI SELECT ..... Selects the input mode to be used.

BNC SELECT ..... Selects the input mode to be used.

HDMI SELECT ... Selects the input mode to be used.

HDMI AUDIO SELECT .. Selects a terminal to which audio signals are input in PC2/AV2 mode.

**QUICK SHOOT**

Reduces the visual lag inherent in fast-motion scenes.

**AUDIO OUTPUT**

Sets the volume of sound output from the PC/AV audio output terminals.

VARIABLE ..... You can adjust the volume using VOLUME.

FIXED ..... Fixes the sounds.

**INPUT SIGNAL (PC3/PC4)**

If a computer connected to the PC3/PC4 input terminal outputs any of the following resolutions, make a selection from the following options.

480 LINES ..... AUTO, 640x480 or 848x480

768 LINES ..... AUTO, 1024x768, 1280x768, or 1360x768

1050 LINES ..... 1400x1050 or 1680x1050

**SCAN MODE (AV input)**

Sets the scan mode used for AV mode input.

MODE1 ..... Over-scan display

MODE2 ..... Under-scan display

MODE3 ..... Under-scan display when the input signal is 1080i/p. Otherwise, over-scan display

\* Even when MODE1 is selected, under-scan display is used when the input signal is 1080i/p and the screen size is Dot by Dot.

**SELF ADJUST**

On a PC3/PC4 screen, specify whether to perform screen adjustment automatically or not. When ON is selected, the screen is automatically adjusted when its resolution is 800 x 600 or higher and the timing of input signals changes. "ADJUSTING" appears on the screen during the adjustment.

**POWER MANAGEMENT**

POWER MANAGEMENT determines whether or not to switch modes from no signal to the input signal standby mode when the PC screen is displayed.

**AUTO INPUT CHANGE**

Specify whether to change inputs automatically. When ON is selected and no signal is present in the selected input mode, AUTO INPUT CHANGE automatically changes the selected mode to another mode where a video signal is present.

When video signals exist in multiple input modes, the switching priority is as follows:

PC1, PC2, PC3, PC4, AV1, AV2, AV3, AV4 and AV5.

(Input mode switching may take 15 seconds or more, depending on the connected equipment. Input signals may not be detected properly and a priority may change, depending on the connected equipment or video signals.)

## Menu Items

### COLOR SYSTEM

Select the color system of the AV equipment which is connected to AV4 and AV5 input terminal. (AUTO / PAL / PAL-60 / SECAM / NTSC3.58 / NTSC4.43)  
When AUTO is selected, the color system is automatically set according to the input signal.

### ■ENLARGE (PC input)

#### ENLARGE H

Sets the number of screen splits (number of monitors) in the longest direction used for the enlargement. (See page 9.)

#### ENLARGE V

Sets the number of screen splits (number of monitors) in the shortest direction used for the enlargement. (See page 9.)

#### ENLARGE-POS H / ENLARGE-POS V

Specify the split screen to be displayed when the enlargement function is used. (See page 9.)

#### BEZEL H / BEZEL V

Sets the frame width of the display when the enlargement function is used.

#### H-POS

Adjust the horizontal position of the enlarged screen.

#### V-POS

Adjust the vertical position of the enlarged screen.

### ■PIP/PbyP

#### PIP MODES

Sets the display method.

OFF .....Displays one screen.

PIP.....Displays a sub screen inside a main screen.

PbyP.....Displays a main screen and a sub screen in a line.

PbyP2.....Displays a main screen which measures 1280 pixels in the longest direction and a sub screen in a line.

#### PIP SIZE

Sets the size of the sub screen in PIP mode.

#### PIP H-POS

Adjusts the horizontal position of the sub screen in PIP mode.

#### PIP V-POS

Adjusts the vertical position of the sub screen in PIP mode.

#### PIP BLEND

In PIP mode, use this menu item to display the sub screen transparently.

#### PIP SOURCE

Selects the input signal of the sub screen in PIP, PbyP, or PbyP2 mode.

#### SOUND CHANGE

Sets the sound which is output in PIP, PbyP, or PbyP2 mode. If the main screen is displayed as a full screen by the AUTO OFF function, the sound for the main screen is output even when the sound for the sub screen is specified.

#### MAIN POS

Sets the position of the main screen in PbyP or PbyP2 mode.

#### PbyP2 POS

Sets the position of the sub screen in PbyP2 mode.

### AUTO OFF

Sets the display method when no signals for the sub screen are input in PIP, PbyP, or PbyP2 mode.

MANUAL..... Displays a main screen and a black sub screen.

AUTO..... Displays the main screen as a full screen.

#### TIPS

- When WHITE BALANCE is set to THRU, BLACK LEVEL, CONTRAST, TINT, COLORS and GAMMA cannot be set.
- If COLOR MODE is set to sRGB or VIVID, the following items cannot be set.  
WHITE BALANCE, PRESET, R-/G-/B-CONTRAST, COPY TO USER, and GAMMA

### ■Dual screen display

You can display the screens of the PC input signal and AV input signal simultaneously.

Set this function with "PIP MODES" in the PIP/PbyP menu.

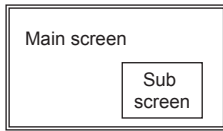
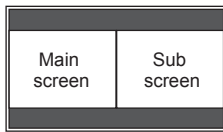
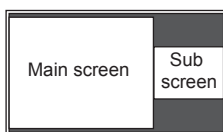
<b>PIP</b>		A sub screen is displayed inside a main screen.
<b>PbyP</b>		A main screen and a sub screen are displayed in a line.
<b>PbyP2</b>		Displays a main screen which measures 1280 pixels in the longest direction and a sub screen in a line.

- \* The currently selected input signal is displayed on the main screen.
- \* You cannot simultaneously display the screens of signals of the same type, such as two types of PC input signals or two types of AV input signals.
- \* The dual screen display cannot be used with the combination of PC1 and AV2 or of AV1 and PC2.

#### TIPS

- You might infringe on a copyright of the author which is protected by copyright law when you display the images of the computer screen and television/VCR simultaneously for profit-making or to show the image to the public.
- The screen size for dual-screen display is the same as the screen size for single-screen display. The Dot by Dot screen is displayed in NORMAL size except when it is set as the PIP main screen.
- When dual-screen display is selected, the AUTO INPUT CHANGE function is disabled.
- When dual-screen display is selected, the screen cannot be enlarged.
- When dual-screen display is selected, the following adjustments of ADVANCED are invalid and adjusting is disabled.  
3D-NR, MPEG-NR and 3D-Y/C
- When dual-screen display is selected, the INPUT SELECT options cannot be set.



## ■Enlarge

- You can align several monitors and integrate them into a single large screen to display.
- Up to five monitors can be aligned in both the longest and shortest directions.
- Each monitor displays enlarged views of separated images.

(Example)

Longest direction: 2 monitors

Shortest direction: 2 monitors

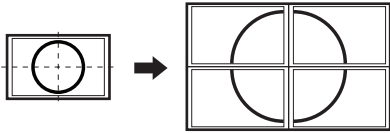

Longest direction: 3 monitors

Shortest direction: 2 monitors

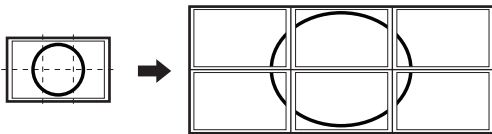

### Setting procedure

In the ENLARGE menu, set ENLARGE H/V and ENLARGE-POS H/V. (See page 8.)

- Set the number of monitors aligned in the longest direction in **ENLARGE H**.
- Set the number of monitors aligned in the shortest direction in **ENLARGE V**.
- Set the section of the separated image to be displayed on each monitor in **ENLARGE-POS H** and **ENLARGE-POS V**.

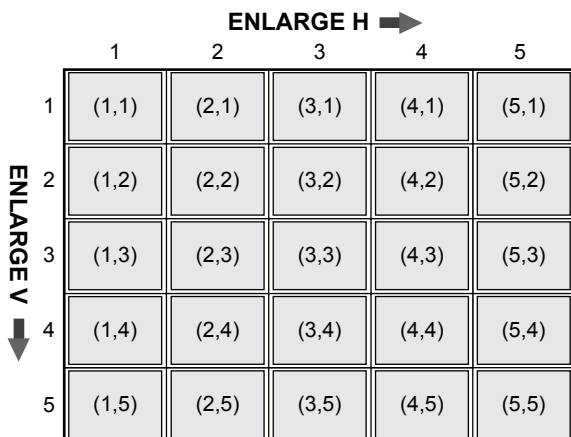

\* The numbers in parentheses are the setting values in (ENLARGE-POS H, ENLARGE-POS V) format.

### TIPS

- AV input signals cannot be used for the Enlarge function.
- To connect 6 or more monitors using PC1 signals, a splitter for the video signal (commercially available) is required.
- When connected in PC2/PC3/PC4, a splitter for the video signal (commercially available) is required.
- When Enlarge is used, the AUTO INPUT CHANGE function is disabled.
- To cancel the enlargement, set 1 for ENLARGE H and ENLARGE V respectively.

## ■SCHEDULE

You can set the time to switch the monitor on and off. Set this function with "SCHEDULE" in the OPTION menu. (See page 7.)

SCHEDULE		< PC3 D-SUB >					
No.	(1)	POWER (2)	DAY OF THE WEEK (3)			TIME (4)	INPUT (5)
1	---	---	---	---	---	---	---
2	---	---	---	---	---	---	---
3	---	---	---	---	---	---	---
4	---	---	---	---	---	---	---
5	---	---	---	---	---	---	---
6	---	---	---	---	---	---	---
7	---	---	---	---	---	---	---
8	---	---	---	---	---	---	---

OK...[MENU]

1920x1080    V: 60 Hz    H: 66.3 kHz

- Press or to select the SCHEDULE number, and press .
- Set the SCHEDULE. (See the description below.)  
Press or to select items, and press or to change the setting.
- Press .  
SCHEDULE becomes effective.

### (1)

- : SCHEDULE effective
- : SCHEDULE not effective

### (2) POWER

ON : Switches the monitor on at the specified time.  
OFF : Switches the monitor off at the specified time and puts the monitor in standby mode.

### (3) DAY OF THE WEEK

Specifies the day of the week to execute the SCHEDULE.

ONLY ONCE:

Executes the SCHEDULE once on the specified day.

Specify the day of the week to execute the SCHEDULE.

EVERY WEEK:

Executes the SCHEDULE on the specified day of the week every week. Specify the day of the week to execute the SCHEDULE.

Periodic setting such as "Monday through Friday" is also possible.

EVERY DAY:

Executes the SCHEDULE every day regardless of the day of the week.

### (4) TIME

Specifies the time to execute the SCHEDULE.

Set the time on a 24-hour basis.

### (5) INPUT

Specifies the input mode at power-on. When not specifying, the screen at the previous power-off appears.

Input modes displayed on "PC1/AV1" depend on DVI

SELECT settings.

Input modes displayed on "PC2/AV2" depend on HDMI

SELECT settings.

Input modes displayed on "PC4/AV3" depend on BNC

SELECT settings.

## Menu Items

### Caution

- Do not switch off the main power after setting the SCHEDULE.
- Specify the correct date and time. (See page 7.) SCHEDULE does not function unless the date and time are specified.
- Check regularly that the set date and time are correct.
- When the SCHEDULE is set, the setting of STANDBY MODE is disabled. (The current power consumption will be the same as when STANDARD is set.)

### TIPS

- Up to 8 SCHEDULE items can be registered.
- Setting the SCHEDULE flashes the power LED alternately in red and orange in standby mode.
- A SCHEDULE that has a large number has precedence over that of a small number when schedules overlap.

## ■ADVANCED items (AV input) (See page 6.)

### FLESH TONE

Adjust the hue control.

### 3D-NR

Reduce the noise of playback images on video. Setting a higher level reduces more noise. However, it may cause blurring on an image.

### MPEG-NR

Reduce block noise caused by digital compression.

### 3D-Y/C (AV5)

Specify whether to perform 3-dimension Y/C separation. If dot interference or cross-color is occurring in fast-motion scenes, selecting "OFF" may improve the image quality.

### C.M.S.-HUE

Adjusts color tone with 6 colors of R (red), Y (yellow), G (green), C (cyan), B (blue), and M (magenta).

### C.M.S.-SATURATION

Adjusts color vividness with 6 colors of R (red), Y (yellow), G (green), C (cyan), B (blue), and M (magenta).

### C.M.S.-VALUE

Adjusts color brightness with 6 colors of R (red), Y (yellow), G (green), C (cyan), B (blue), and M (magenta).







### TIPS

- When FLESH TONE is set to LOW or HIGH, C.M.S.-HUE/-SATURATION/-VALUE cannot be set.

## Adjustments for PC screen display

### ■Automatic adjustment

When you use the PC3 input terminal or PC4 input terminals to display a PC screen for the first time, or when you change the setting of the PC, use the automatic screen adjustment.

1. **Switch the input to PC3 or to PC4 and display the adjustment pattern.** (See the description below.)
  2. Press  and use  or  to display the SCREEN menu.
  3. Press  and select "AUTO".
  4. Press .
- The automatic adjustment is complete in several seconds.
5. Press  twice to close the menu screen.

### TIPS

- If the screen cannot be adjusted properly with one automatic adjustment, repeat the automatic adjustment two or three times. Try manual adjustment if necessary.

### ■Screen display for adjustment

Before making adjustments in the SCREEN menu or PICTURE menu, display an image to brighten the entire screen. If you are using a Windows PC, use the adjustment pattern on the supplied CD-ROM.

#### Opening the adjustment pattern

1. Load the supplied CD-ROM into the computer's CD-ROM drive.
2. Open the CD-ROM in [My Computer].
3. Double-click [Adj\_uty.exe].  
The adjustment pattern will appear.  
Adjust the screen automatically or manually.

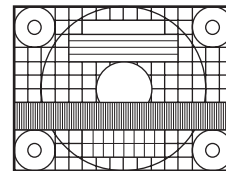

4. When adjustment is finished, press the [Esc] on the computer's keyboard to quit the adjustment program.
5. Eject the CD-ROM from the CD-ROM drive.

### TIPS

- If the display mode on the computer you are using is 65,000 colors, the color levels in the color pattern may appear differently or grayscale may appear to be colored. (This is due to the specifications of the input signal and is not a malfunction.)

# Initialization (Reset)/Functional Restriction Setting

You can return the settings to their factory-preset values and restrict operations.

1. After pressing **SIZE** for about 5 seconds, press **▲**, **▼**, and **▶** in that order.

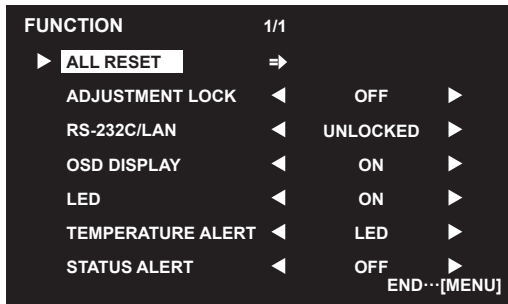

2. Select and set the items.

## ALL RESET

Resets the settings to the factory default settings.

Press **▶**, select the resetting method, and then press **MENU**.

After initialization, turn the main power switch off and then back on.

ALL RESET1 ....Resets all the settings to the factory default settings.

ALL RESET2 ....Returns all settings to the factory default settings except for the following items:  
LAN SETUP, RS-232C/LAN SELECT, NETWORK, MAIL, and SERVICE & SUPPORT (See page 7, and pages 25 to 28.)

## ADJUSTMENT LOCK

You can disable operations on the monitor and the remote control unit that use buttons.

OFF ... Enables operation.

1..... Disables all operations other than turning power on/off and FUNCTION.

2..... Only the FUNCTION operation is enabled.  
Disables all operations other than FUNCTION (not even power on/off).

## RS-232C/LAN

Specifies whether to allow control via RS-232C or LAN (see pages 12 and 21).

## OSD DISPLAY

Hides/shows menus.

The FUNCTION screen cannot be hidden.

## LED

Specifies whether to light power LEDs.

## TEMPERATURE ALERT

Selects the notification method for an abnormal temperature.

OFF ..... Do not notify about an abnormal temperature.

OSD & LED .. When an abnormal temperature is detected, the power LED flashes in red and green alternately and the screen displays a message: TEMPERATURE.

LED..... When an abnormal temperature is detected, the power LED flashes in red and green alternately.

## STATUS ALERT

Selects the notification method for a hardware error.

OFF ..... Do not notify about the error.

OSD & LED .. When a hardware error is detected, the power LED flashes in red and the screen displays a message: STATUS [xxxx].

LED..... When a hardware error is detected, the power LED flashes in red.

3. Press **MENU** to return to the normal screen.

## TIPS

- When both abnormal temperature and hardware error are detected, the hardware error notification overrides.

# Controlling the Monitor with a PC (RS-232C)

You can control this monitor from a PC via RS-232C (COM port) on the PC.

You can also connect multiple monitors via a daisy chain by using a PC. By assigning ID numbers to each monitor (see page 13), you can make input mode selection/adjustment or can check the status of a specific monitor.

## ! Caution

- To control the monitor via RS-232C, set RS-232C/LAN SELECT to RS-232C.
- You cannot use RS-232C and LAN control simultaneously.

## PC connection

### ■ One-to-one connection with a PC

Connect with RS-232 straight cable between the PC's COM port (RS-232C connector) and the RS-232C input terminal on the monitor.

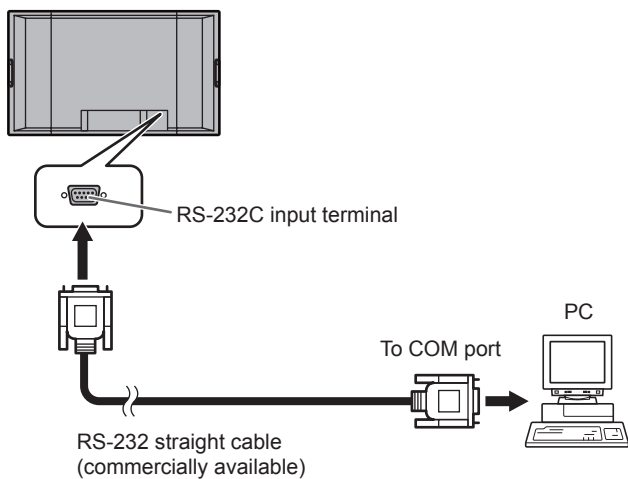

### ■ Daisy chain connection... **Advanced operation**

Connect with RS-232 straight cable between the PC's COM port (RS-232C connector) and the RS-232C input terminal on the first monitor.

Next, connect RS-232 straight cable to the first monitor's RS-232C output terminal and to the second monitor's RS-232C input terminal. Connect in the same way to the third and subsequent monitors.

Up to 25 monitors can be connected. (Depending on the length of the cable used and the surrounding environment.)

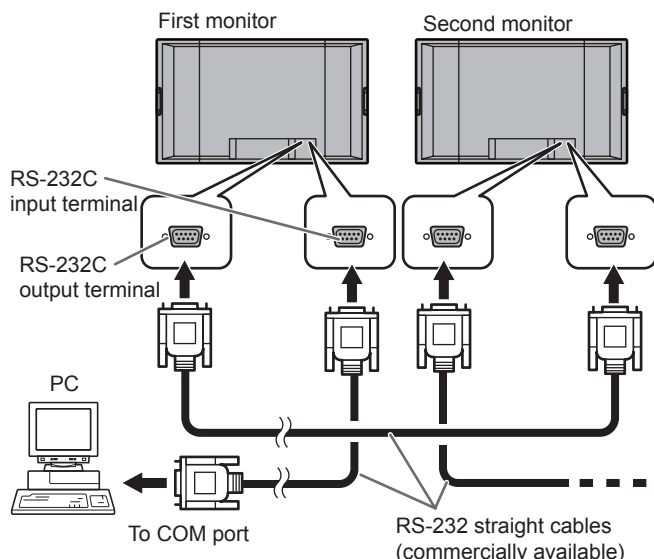

## Communication conditions

Set the RS-232C communication settings on the PC to match the monitor's communication settings as follows:

Baud rate	9600 bps	Stop bit	1 bit
Data length	8 bits	Flow control	None
Parity bit	None		

## Communication procedure

### ■ Command format

When a command is sent from the PC to the monitor, the monitor operates according to the received command and sends a response message to the PC.

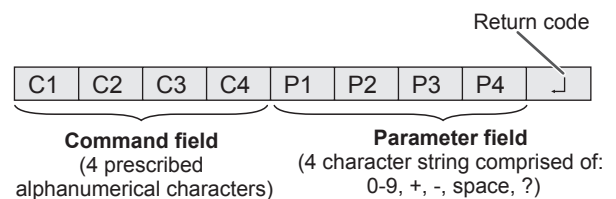

Example: VOLM0030  
VOLM \_ \_ 30

- \* Be sure to input 4 characters for the parameter. Pad with spaces (" ") if necessary.

(" " is a return code (0DH, 0AH or 0DH))

Wrong : VOLM30

Right : VOLM \_ \_ 30

When inputting a negative value, specify a numerical value in three digits.

Example: AUTC-009

Do not use spaces for MPOS, DATE, and SC01 through SC08. Specify parameters using a specified number of characters.

Example: MPOS010097

If a command has "R" listed for "DIRECTION" in the "RS-232C command table" on page 16, the current value can be returned by using "?" as the parameter.

Example:

VOLM ? ? ? ? ← From PC to monitor (How much is current volume setting?).

30 ← From monitor to PC (Current volume setting: 30).

- \* If an ID number (see page 13) has been assigned (For example, ID number = 1).

VOLM \_ \_ \_ ? ← From PC to monitor.

30 \_ 001 ← From monitor to PC.

## Response code format

When a command has been executed correctly

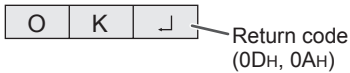

A response is returned after a command is executed.

- \* If an ID number has been assigned

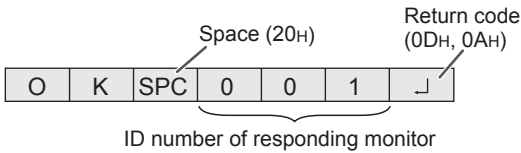

When a command has not been executed

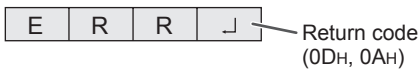

- \* If an ID number has been assigned

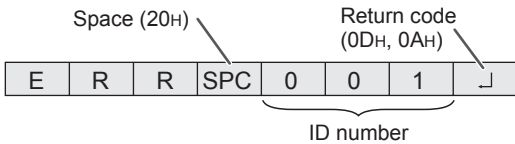

### TIPS

- "ERR" is returned when there is no relevant command or when the command cannot be used in the current state of the monitor.
- If communication has not been established for reasons such as a bad connection between the PC and monitor, nothing is returned (not even ERR).
- If no monitor has been assigned the designated ID number (e.g. if the command IDSL0002  is used, but no monitor with ID number: 2 is found), no response is returned.
- If RS-232C/LAN COMMAND is set to options other than NORMAL, the return code for a response is 0D<sub>H</sub> only.

If execution of the command is taking some time



When the following commands are used, "WAIT" is returned. In this case, a value will be returned if you wait a while. Do not send any command during this period.

No ID number is attached to WAIT response.

- Commands which return WAIT:
  1. When repeater control is used
  2. When an IDSL or IDLK command is used
  3. When one of the following commands is used: RSET, INPS, ASNC, WIDE, EMAG, EPOS, PXSL, POWR, AGIN, MWIN, MWIP, MWPP, ESTG, EMHV, EPHV, ESHV

When control via RS-232C is locked (to prevent use) using the operation lock function (see page 11)



When RS-232C/LAN SELECT is set to LAN

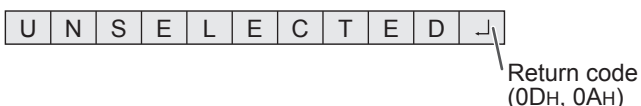

## Communication interval

- After OK or ERR is returned, you must send the following commands.  
To set a timeout for the command response, specify 10 seconds or longer.
- Provide an interval of 100 ms or more between the command response and the transmission of the next command.

```
VOLM0020
OK
```

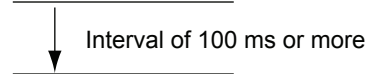

```
INPS0001
WAIT
OK
```

### TIPS

- When executing ALL RESET, set the timeout period to 30 seconds or longer.
- When turning the power on while the POWER ON DELAY function is in use, set the timeout period to the POWER ON DELAY period + 10 seconds or longer.

## Advanced operation

This section explains commands for daisy chain connection. The basic communication procedure is the same as in the "One-to-one connection with a PC" section.

## ID numbers

You can assign a unique ID number to each monitor (see page 7). This allows you to control a particular monitor in a daisy chain of monitors.

You can assign ID numbers either from the menu screen (using the remote control) or from the PC using RS-232 cable.

[Example]

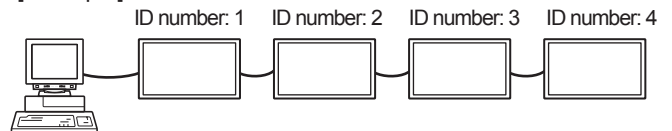

If monitors are connected as shown above, you can execute commands like "Set the volume of the monitor with ID 4 to 20".

When controlling monitors linked in a daisy chain by designating ID numbers, you should basically avoid any duplication of ID numbers.

ID numbers do not have to be assigned in ascending order starting from the PC. They can also be connected as shown below.

[Example]

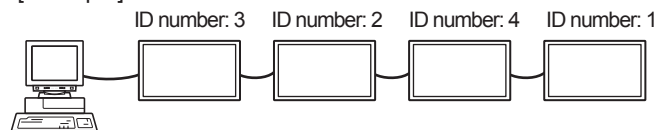

## Controlling the Monitor with a PC (RS-232C)

### ■ Commands for ID control

The command examples shown on this page assume the following connection and ID number set up.

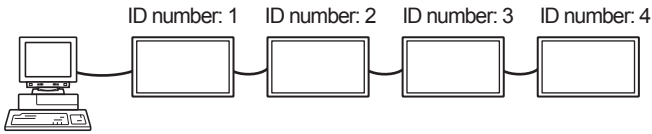

**IDST** .....A monitor receiving this command sets its own ID number in the parameter field.

Example:

IDST0001

OK \_ 001 ← The ID number of this monitor is set to 1.

#### TIPS

You can automatically assign ID numbers by using the IDST command with the Repeater control (see “Repeater control” on page 15).

For example, using the command “IDST001+” automatically sets the ID numbers, as shown below.

[Example]

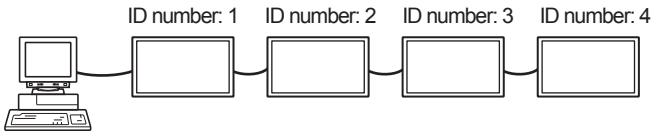

IDST001 + ← ID setting command with repeater control

WAIT

OK \_ 001 ← “OK” response from ID number: 1

OK \_ 002 ← “OK” response from ID number: 2

OK \_ 003 ← “OK” response from ID number: 3

OK \_ 004 ← “OK” response from ID number: 4 (End)

**IDSL** .....The parameter of this command sets the ID number of the monitor. The monitor is subject to the next command.

Example:

IDSL0002 ← The next command is for the monitor with ID number: 2.

WAIT ← Searching for monitor with ID number: 2

OK \_ 002 ← Found monitor with ID number: 2

VOLM0030 ← Sets volume of monitor with ID number: 2 to 30.

WAIT ← Processing

OK \_ 002 ← OK response from monitor with ID number: 2

VOLM0020 ← Sets volume to 20.

OK \_ 001 ← The volume of the monitor with ID number: 1 (the one directly connected to the PC) is set to 20.\*

\* The IDSL command is effective only once, for the immediately succeeding command.

**IDLK** .....The parameter of this command sets the ID number of the monitor. The monitor is subject to all subsequent commands.

Example:

IDLK0002 ← Following commands are for the monitor with ID number: 2.

WAIT ← Searching for monitor with ID number: 2

OK \_ 002 ← Found monitor with ID number: 2

VOLM0030 ← Sets volume of monitor with ID number: 2 to 30.\*

WAIT ← Processing

OK \_ 002

VOLM0020 ← Sets volume of monitor with ID number: 2 to 20.\*

WAIT

OK \_ 002

IDLK0000 ← Canceling fixed ID number setting

WAIT ← Canceling IDLK

OK \_ 002 ← Cancellation complete

VOLM0010

OK \_ 001 ← The volume of the monitor with ID number: 1 (the one directly connected to the PC) is set to 10. (IDLK is canceled.)

\* The IDLK command remains effective until it is canceled, or power is shut off.

**IDCK**.....Provides screen display of the ID number currently assigned to a monitor, and the ID number currently set for IDLK (if any).

Example:

(After executing IDLK0002)

IDCK0000 ← (Parameter has no meaning.)

ID : 001 IDLK : 002 ← Returned response. The ID number is also displayed on the monitor screen.

IDCK000 + ← Repeater control. (If a command is used with repeater control, ID designation using IDSL or IDLK is canceled.)

WAIT

ID : 001 IDLK : 000

ID : 002 IDLK : 000

ID : 003 IDLK : 000

ID : 004 IDLK : 000

## ■ Repeater control

This system has a function to allow setting of multiple monitors connected in a daisy chain using a single command. This function is called repeater control. You can use Repeater control function without assigning ID numbers.

[Example]

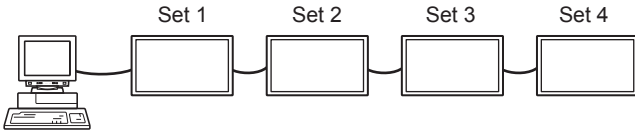

\* If monitors are connected as shown above, you can execute a command like "Set all monitors' input settings to PC1 DVI-D".

## ■ Repeater control command

Repeater control is achieved by setting the FOURTH CHARACTER of the parameter to "+".

Example:

VOLM030 + ← Sets volume of all monitors to 30.

In repeater control, responses are returned by all the connected monitors.

If you want to determine that a value has been returned by a specific set, assign ID numbers to each monitor in advance. When some monitors do not return their responses, the probable cause is that the monitors could not receive the command or command processing is not complete. Do not send a new command.

Example: (When 4 monitors are connected, and assigned ID numbers: 1 through 4)

```
VOLM030 +
WAIT
OK _ 001
OK _ 002
OK _ 003
OK _ 004 ← If 4 monitors are connected in
              a chain, reliable operation can
              be ensured by sending a new
              command only after a reply
              has been returned by 4th (last)
              monitor.
```

Repeater control can also be used for reading settings.

Example:

```
VOLM ??? +
WAIT
10 _ 001
20 _ 002
30 _ 003
30 _ 004
```

Volume settings for all monitors are returned.

### TIPS

- If repeater control is used during ID designation (IDSL, IDLK), the ID designation is canceled.

## Controlling the Monitor with a PC (RS-232C)

### RS-232C command table

#### How to read the command table

- Command: Command field (See page 12.)
- Direction: W When the "Parameter" is set in the parameter field (see page 12), the command functions as described under "Control/Response Contents".  
 R The returned value indicated under "Reply" can be obtained by setting "????", "\_\_\_\_?" or "???" (repeater control) in the parameter field (see page 12).
- Parameter: Parameter field (See page 12.)
- Reply: Response (Returned value)
- \*: "A" indicates a command which can be used in power standby mode regardless of the STANDBY MODE setting.  
 "B" indicates command which can be used in power standby mode when STANDBY MODE is set to STANDARD. (It cannot be used in the power standby mode when LOW POWER is selected.)  
 "-" indicates a command which cannot be used in power standby mode.

#### Power control/Input mode selection

Function	Command	Direction	Parameter	Reply	Control/Response contents	*	
POWER CONTROL	POWR	W	0		Switches to standby mode.	A	
			1		Returns from standby mode.		
		R		0			Standby mode
				1			Normal mode
				2			Input signal waiting mode
INPUT MODE SELECTION	INPS	W	0		Toggle change for input mode. Terminals not selected in DVI SELECT/ BNC SELECT/HDMI SELECT cannot be selected.	B	
			1		PC1 DVI-D "ERR" when AV1 DVI-D is selected for DVI SELECT.		
			2		PC3 D-SUB		
			3		AV3 COMPONENT "ERR" when PC4 RGB is selected for BNC SELECT.		
			4		AV5 VIDEO		
			6		PC4 RGB "ERR" when AV3 COMPONENT is selected for BNC SELECT.		
			7		AV1 DVI-D "ERR" when PC1 DVI-D is selected for DVI SELECT.		
			8		AV4 S-VIDEO		
			9		AV2 HDMI "ERR" when PC2 HDMI is selected for HDMI SELECT.		
			10		PC2 HDMI "ERR" when AV2 HDMI is selected for HDMI SELECT.		
		R		1		PC1 DVI-D	A
				2		PC3 D-SUB	
				3		AV3 COMPONENT	
				4		AV5 VIDEO	
				6		PC4 RGB	
				7		AV1 DVI-D	
				8		AV4 S-VIDEO	
				9		AV2 HDMI	
				10		PC2 HDMI	

#### SCREEN menu

Function	Command	Direction	Parameter	Reply	Control/Response contents	*	
AUTO	ASNC	W	1		When the input mode is PC3, PC4.	-	
CLOCK	CLCK	WR	0-1200	0-1200	When the input mode is PC3, PC4. Varies depending on the signal.		
PHASE	PHSE	WR	0-63	0-63	When the input mode is PC3, PC4.		
POSITIONING	POSITION OF THE LONGEST DIRECTION	HPOS	WR	0-100	0-100		0-800 on PC3/PC4. Varies depending on the signal.
	POSITION OF THE SHORTEST DIRECTION	VPOS	WR	0-100	0-100		0-200 on PC3/PC4. Varies depending on the signal.
SIZE	POSITION OF THE LONGEST DIRECTION	HSIZ	WR	0-100	0-100		
	POSITION OF THE SHORTEST DIRECTION	VSIZ	WR	0-100	0-100		
RESOLUTION	H-RESOLUTION	HRES	WR	300-1920	300-1920		When the input mode is PC3, PC4.
	V-RESOLUTION	VRES	WR	200-1200	200-1200		Only even numbers are valid for parameters. Varies depending on the signal.
RESET	ARST	W	1				



## PICTURE menu

Function	Command	Direction	Parameter	Reply	Control/Response contents	*	
AUTO	AGIN	W	1		When the input mode is PC3, PC4.	-	
CONTRAST	CONT	WR	0-60	0-60	0-127 on PC3/PC4.	B	
BLACK LEVEL	BLVL	WR	0-60	0-60	0-127 on PC3/PC4.		
TINT	TINT	WR	0-60	0-60			
COLORS	COLR	WR	0-60	0-60			
SHARPNESS	SHRP	WR	0-24	0-24			
ADVANCED (When the input mode is AV.)	FLESH TONE	FLES	WR	0-2	0-2	0: OFF, 1: LOW, 2: HIGH	B
	3D-NR	TDNR	WR	0-2	0-2	0: OFF, 1: LOW, 2: HIGH	
	MPEG-NR	MPNR	WR	0-1	0-1	0: OFF, 1: ON	
	3D-Y/C	YCSP	WR	0-1	0-1	0: OFF, 1: ON (When the input mode is AV5)	
	C.M.S.-HUE	CMHR	WR	-10-10	-10-10	R	B
						Y	
						G	
						C	
						B	
						M	
		CRST	W	1		Resets the hue.	
	C.M.S.-SATURATION	CMSR	WR	-10-10	-10-10	R	B
						Y	
						G	
						C	
						B	
						M	
		CRST	W	2		Resets the saturation.	
	C.M.S.-VALUE	CMVR	WR	-10-10	-10-10	R	B
						Y	
G							
C							
B							
M							
CRST		W	3		Resets the brightness.		
COLOR MODE	BMOD	WR	0	0	STD	B	
			2	2	VIVID		
			3	3	sRGB (When the input mode is PC)		
WHITE BALANCE	THRU	CTMP	WR	0	0	When the input mode is PC1/PC2.	B
	PRESET			1-15	1-15	From 1: approximately 3,000K to 15: approximately 10,000K (500K steps)	
	USER			99	99		
	R-CONTRAST	CRTR	WR	0-512	0-512	"ERR" when CTMP is not set to 99.	
	G-CONTRAST	CRTG	WR	0-512	0-512		
	B-CONTRAST	CRTB	WR	0-512	0-512		
COPY TO USER	CPTU	W	0		Copies a preset value to the user setting.	-	
GAMMA	GAMM	WR	0-2	0-2	0: 1.8, 1: 2.2, 2: 2.4	B	
RESET	ARST	W	2			-	

## AUDIO menu

Function	Command	Direction	Parameter	Reply	Control/Response contents	*
TREBLE	AUTR	WR	-10-10	-10-10		B
BASS	AUBS	WR	-10-10	-10-10		
BALANCE	AUBL	WR	-10-10	-10-10		
RESET	ARST	W	3			-

# Controlling the Monitor with a PC (RS-232C)

## SETUP menu

Function		Command	Direction	Parameter	Reply	Control/Response contents	*
OSD H-POSITION		OSDH	WR	0-100	0-100		B
OSD V-POSITION		OSDV	WR	0-100	0-100		B
LANGUAGE		LANG	WR	14	14	ENGLISH	B
				1	1	DEUTSCH	
				2	2	FRANÇAIS	
				3	3	ITALIANO	
				4	4	ESPAÑOL	
				5	5	РУССКИЙ	
HDMI AUTO VIEW		HDAW	WR	0-1	0-1	0: OFF, 1: ON	B
PICTURE FLIP		PFIL	WR	0-3	0-3	0: STANDARD, 1: MIRROR, 2: UPSIDE DOWN, 3: ROTATE	B
Power On Delay		PWOD	WR	0	0	OFF	B
				1-60	1-60	ON	
STANDBY MODE		STBM	WR	0-1	0-1	0: STANDARD, 1: LOW POWER	B
RS-232C/LAN SELECT		CTLS	WR	0-1	0-1	0: RS-232C 1: LAN	B
RS-232C/LAN COMMAND		CMDM	WR	0-2	0-2	0: NORMAL, 1: MODE1, 2: MODE2	B
ID NUMBER	ID NO. SETTING	IDST	W	0-255		Sets the monitor's ID number. ("0" means "no ID number".)	A
					R	0-255	
	ID NO. SETTING (ONCE)	IDSL	W	1-255		Sets a monitor ID number. This ID number is only effective for the command immediately after this command.	
					0	Clears the ID number if one has been designated.	
	ID NO. SETTING (SUBSEQUENT)	IDLK	W	1-255		Sets a monitor ID number. This ID number is effective for the next and all subsequent commands after this command.	
0					Clears the ID number if one has been designated.		
ID CHECK	IDCK	W	0	ID : xxx IDLK : yyy	Displays monitor's own ID number and the selected ID number on the screen.	B	

## OPTION menu

Function		Command	Direction	Parameter	Reply	Control/Response contents	*
DATE/TIME SETTING		DATE	WR	AABBCCDDEE	AABBCCDDEE	AA: Year, BB: Month, CC: Day, DD: Time, EE: Minute	B
SCHEDULE		SC01-SC08	WR	ABCDEFGHIJGH	ABCDEFGHIJGH	Schedule of a specified number A: Schedule 0 = Not effective, 1 = Effective B: Power 0 = OFF, 1 = ON C: Day of the week 1 0 = Only once, 1 = Every week, 2 = Every day D: Day of the week 2 0 = Sunday, 1 = Monday through 6 = Saturday, 9 = Not exist E: Day of the week 3 0 = Sunday, 1 = Monday through 6 = Saturday, 9 = Not exist F: Time 00-23 G: Minute 00-59 H: Input 0 = Not specified, 1 = PC1/AV1, 2 = PC3, 3 = PC4/AV3, 4 = AV5, 5 = AV4, 6 = PC2/AV2	B
INPUT SELECT	DVI SELECT	DVSL	WR	0-1	0-1	0: PC1 DVI-D, 1: AV1 DVI-D	B
	BNC SELECT	BNSL	WR	0-1	0-1	0: PC4 RGB, 1: AV3 COMPONENT	B
	HDMI SELECT	HDSL	WR	0-1	0-1	0: PC2 HDMI, 1: AV2 HDMI	B
	HDMI AUDIO SELECT	HMDA	WR	0-1	0-1	0: DIGITAL, 1: ANALOG	B
QUICK SHOOT (PC)		QSPC	WR	0-1	0-1	0: OFF, 1: ON	B
QUICK SHOOT (AV)		QSAV	WR	0-1	0-1	0: OFF, 1: ON	B
AUDIO OUTPUT		AOUT	WR	0-1	0-1	0: VARIABLE, 1: FIXED	B
INPUT RESOLUTION (PC)	RESOLUTION CHECK	PXCK	R			Returns current resolution in the form of hhh, vvv.	-
	PIXEL SETTING (PC3, PC4)	PXSL	WR	1	1	V: 768) 1360 x 768	
				2	2	V: 768) 1280 x 768	
				3	3	V: 768) 1024 x 768	
				5	5	V: 480) 848 x 480	
				6	6	V: 480) 640 x 480	
				7	7	V: 1050) 1680 x 1050	
				8	8	V: 1050) 1400 x 1050	
				9	9	V: 768) AUTO	
				10	10	V: 480) AUTO	
INPUT RESOLUTION (AV)	RESOLUTION CHECK	RESO	R		-	480i, 480p, 1080i, 720p, 1080p, VGA, etc.	-
SCAN MODE		SCAN	WR	0-2	0-2	0: MODE1, 1: MODE2, 2: MODE3 (When the input mode is AV)	B
SELF ADJUST		AADJ	WR	0-1	0-1	0: OFF, 1: ON	B
POWER MANAGEMENT		PMNG	WR	0-1	0-1	0: OFF, 1: ON	B
AUTO INPUT CHANGE		AINC	WR	0-1	0-1	0: OFF, 1: ON	B
COLOR SYSTEM		CSYS	WR	0-5	0-5	0: AUTO, 1: PAL, 2: PAL-60, 3: SECAM, 4: NTSC3.58, 5: NTSC4.43	B

## ENLARGE menu (When the input mode is PC)

Function		Command	Direction	Parameter	Reply	Control/Response contents	*
ENLARGE MODE		EMAG	WR	0-4	0-4	0: OFF, 1: 2 x 2, 2: 3 x 3, 3: 4 x 4, 4: 5 x 5	
		EMHV	WR	11-55	11-55	1 x 1 (OFF) to 5 x 5 ("m x n" is expressed as "mn", where m and n are the numbers of monitors specified for the longest direction and the shortest direction respectively.)	
BEZEL WIDTH	WIDTH OF THE SHORTER SIDE	BEZH	WR	0-100	0-100		
	WIDTH OF THE LONGER SIDE	BEZV	WR	0-100	0-100		
IMAGE POSITION (M x N)		EPHV	WR	11-55	11-55	Specify values in the order of ENLARGE-POS H/ENLARGE-POS V. (See page 9.)	
IMAGE POSITION (2 x 2)		EPOS	WR	0-3	0-3	See the description below.	
IMAGE POSITION (3 x 3)		EPOS	WR	0-8	0-8		
IMAGE POSITION (4 x 4)		EPOS	WR	0-15	0-15		
IMAGE POSITION (5 x 5)		EPOS	WR	0-24	0-24		
ENLARGED SCREEN POSITIONING	THE LONGEST DIRECTION	EPSH	WR	-999-999	-999-999	The setting range depends on the ENLARGE MODE setting and the IMAGE POSITION.	
	THE SHORTEST DIRECTION	EPSV	WR	-999-999	-999-999		
ENLARGE/IMAGE POSITION SETTING		ESTG	WR	XXYY	XXYY	XX: ENLARGE MODE (Same as EMAG), YY: IMAGE POSITION (Same as EPOS)	
		ESHV	WR	XXYY	XXYY	XX: ENLARGE MODE (Same as EMHV), YY: IMAGE POSITION (Same as EPHV)	

• IMAGE POSITION (EPOS) setting

2 x 2

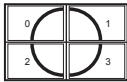

3 x 3

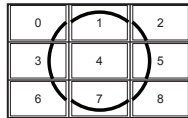

4 x 4

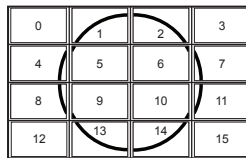

5 x 5

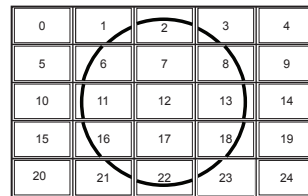

## PIP/PbyP menu

Function		Command	Direction	Parameter	Reply	Control/Response contents	*
PIP MODES		MWIN	WR	0-3	0-3	0: OFF, 1: PIP, 2: PbyP, 3: PbyP2	B
PIP SIZE		MPSZ	WR	1-12	1-12		B
PIP POS	THE LONGEST DIRECTION	MHPS	W	0-100			B
	THE SHORTEST DIRECTION		R		0-100		B
PIP V/H-POS		MPOS	W	0-100,0-100		Specify the position in MPOSxxxxyy format. (xxx: Longer side, yyy: Shorter side position)	B
			R		0-100,0-100	Returns a response in (xxx,yyy) format. (xxx: Longer side, yyy: Shorter side position)	B
PIP BLEND		MWBL	WR	0-15	0-15		B
PIP SOURCE		MWIP	WR	1	1	PC1 DVI-D	B
				2	2	PC3 D-SUB	
				3	3	AV3 COMPONENT	
				4	4	AV5 VIDEO	
				6	6	PC4 RGB	
				7	7	AV1 DVI-D	
				8	8	AV4 S-VIDEO	
				9	9	AV2 HDMI	
				10	10	PC2 HDMI	
SOUND CHANGE				MWAD	WR	1-2	
MAIN POS (Main screen)		MWPP	WR	0-1	0-1	0: POS1, 1: POS2	B
PbyP2 POS (Sub screen)		MW2P	WR	0-2	0-2	0: POS1, 1: POS2, 2: POS3	B
AUTO OFF		MOFF	WR	0-1	0-1	0: MANUAL, 1: AUTO	B

## Initialization/Functional Restriction Setting (FUNCTION) menu

Function	Command	Direction	Parameter	Reply	Control/Response contents	*
ALL RESET	RSET	W	0-1		0: ALL RESET 1, 1: ALL RESET 2	-
ADJUSTMENT LOCK	ALCK	WR	0-2	0-2	0: OFF	B
OSD DISPLAY	LOSD	WR	0-1	0-1	0: ON, 1: OFF	B
LED	OFLD	WR	0-1	0-1	0: ON, 1: OFF	B
TEMPERATURE ALERT	TALT	WR	0-2	0-2	0: OFF, 1: OSD & LED, 2: LED	B
STATUS ALERT	SALT	WR	0-2	0-2	0: OFF, 1: OSD & LED, 2: LED	B

## Controlling the Monitor with a PC (RS-232C)

### Others

Function		Command	Direction	Parameter	Reply	Control/Response contents	*
SCREEN SIZE (PC)		WIDE	WR	1-5	1-5	1: WIDE, 2: NORMAL, 3: Dot by Dot, 4: ZOOM1, 5: ZOOM2	B
SCREEN SIZE (AV)		WIDE	WR	1-5	1-5	1: WIDE, 2: ZOOM1, 3: ZOOM2, 4: NORMAL, 5: Dot by Dot	B
VOLUME		VOLM	WR	0-31	0-31		B
MUTE		MUTE	WR	0-1	0-1	0: OFF, 1: ON	-
INFORMATION	MODEL	INF1	R		Value		A
	SERIAL NO	SRNO	R		Value		
BRIGHT		VLMP	WR	0-31	0-31	Brightness	B
TEMPERATURE SENSOR		DSTA	R		0	Internal temperature normal	A
					1	Internal temperature abnormal (Standby mode)	
					2	Internal temperature abnormal (Temperature is normal now, but it was abnormal during operation.)	
					3	Internal temperature abnormal (Brightness of the backlight decreases.)	
					4	Temperature sensor abnormal	
TEMPERATURE ACQUISITION		ERRT	R		Value	Temperature at temperature sensors 1 through 3 are returned in the following forms: [Sensor 1], [Sensor 2], [Sensor 3] Indicates a temperature sensor abnormality when "126" is returned.	A
CAUSE OF LAST STANDBY MODE		STCA	W	0		Initialization	A
			R	0	No detectable error has occurred		
			1	Standby mode by POWER button			
			2	Main power "OFF" by the main power switch			
			3	Standby mode by RS-232C or LAN			
			4	Waiting mode by No Signal (Incl: VESA DPMS/DMPM)			
			6	Standby mode by abnormal temperature			
			8	Standby mode by SCHEDULE setting			

# Controlling the Monitor with a PC (LAN)

Your monitor can be connected to a LAN allowing you to control it from a PC on the LAN. You can also configure the monitor to send e-mail notification when it has a problem. The connection requires a commercially available LAN cable (UTP cable, Category 5, straight through).

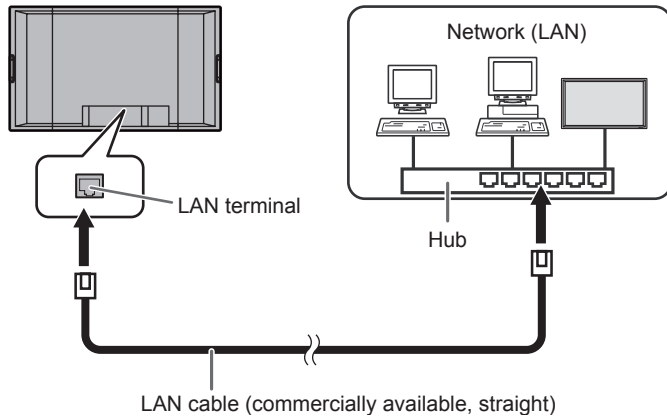

## TIPS

- You must assign an IP address to the monitor by following the procedures in "Settings to connect to a LAN". (See the description on the right.)
- Your PC must be installed with Internet Explorer (version 6.0 or later).
- To control the monitor via LAN, set RS-232C/LAN SELECT to LAN. (See page 7.)
- You cannot use RS-232C and LAN control simultaneously.

## Settings to connect to a LAN

Set the monitor's IP address and subnet mask to match the settings of your LAN.

These settings can be made on either the monitor or a PC connected to the monitor.

The settings depend on the configuration of your LAN. Ask your LAN administrator for details.

### ■ To set on the monitor

Set RS-232C/LAN SELECT on the SETUP menu to LAN, and then set the LAN SETUP options. (See page 7.)

After setting each item, select SET and press .

#### DHCP CLIENT

If your LAN has a DHCP server and you wish to obtain an address automatically, change this setting to ON.

To set the address manually, set this to OFF.

#### IP ADDRESS

If the DHCP CLIENT is set to OFF, specify an IP address.

Press  or  to select items, and press  or  to change the values.

#### SUBNET MASK

If the DHCP CLIENT is set to OFF, specify the subnet mask.

Press  or  to select items, and press  or  to change the values.

#### DEFAULT GATEWAY

If the DHCP CLIENT is set to OFF, specify the default gateway.

If you are not using a gateway, specify "0.0.0.0".

Press  or  to select items, and press  or  to change the values.

#### RESET

Resets the values of the LAN settings to the factory preset values.

Select ON and then press .

## Controlling the Monitor with a PC (LAN)

### ■ To set from a PC

When the monitor is connected to a PC, LAN settings can be configured via PC.

#### Set up process

- (1) Connect your monitor to a PC
- (2) Specify the PC's IP address
- (3) Configure the monitor's LAN settings

#### (1) Connecting your monitor to a PC

Connect a commercially available crossover LAN cable (UPT cable, Category 5) to the LAN port on the PC and this monitor.

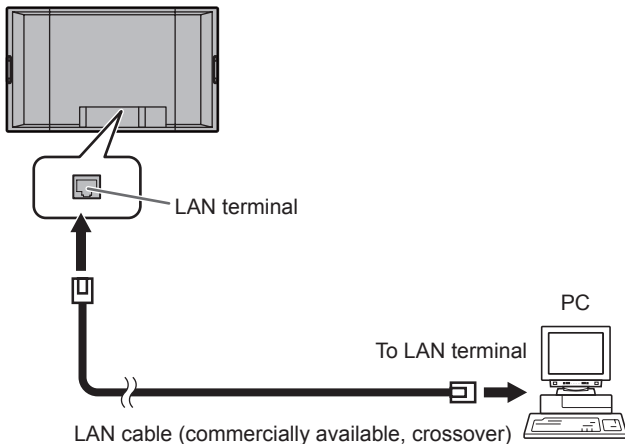

#### (2) Specifying the PC's IP address

To configure the monitor's LAN settings, you must temporarily change the settings on the PC.

This explanation is based on Windows XP.

1. Log on to the PC with an administrator account.
2. Click [Start], and then click "Control Panel".
3. Click "Network and Internet Connections", and then click "Network Connections".  
If you are using the classic display style, double-click on "Network Connections".
4. Right click on "Local Area Connection" and from the menu, click "Properties".
5. Click "Internet Protocol (TCP/IP)", and then click "Properties".
6. Make a note of the current IP address, subnet mask, and default gateway settings.

Make sure you write this information now as you will be changing the IP address, subnet mask, and default gateway settings back to these settings afterwards.

7. Temporarily change the IP address and subnet mask.  
To access the monitor as it is shipped from the factory, set as follows.

- IP Address: 192.168.150.3
- Subnet Mask: 255.255.255.0
- Default Gateway: (leave blank)

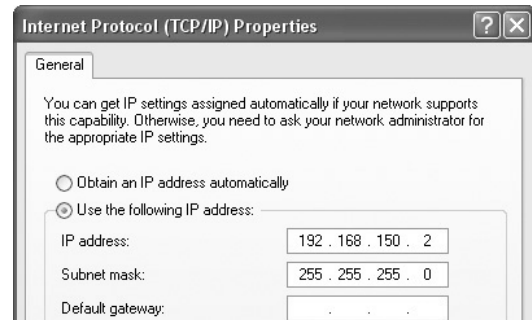

8. Click [OK] and then reboot the PC.

#### TIPS

- This monitor is factory preset as shown below.  
IP Address : 192.168.150.2  
Subnet Mask : 255.255.255.0  
Default Gateway : 0.0.0.0

#### (3) Configuring the monitor's LAN settings

Access the monitor using Internet Explorer.

##### Controlling the monitor

1. Turn the power ON to the monitor.
2. Set RS-232C/LAN SELECT on the SETUP menu to LAN.

##### PC operation

3. Launch Internet Explorer, in the "Address" box type "http://192.168.150.2/" and press the Enter key.



You will be prompted to enter a user name and password.

4. Leave the user name and password boxes blank and click [OK].

5. Click on “LAN SETUP” under NETWORK.

SHARP LCD Monitor PN-S855		PN-S855
INFORMATION		PC3 D-SUB 1920x1080
MODEL	PN-S855	
S/N		
POWER	ON	
DATE/TIME	2008/1/1 TUE 00:45:54 <small>* The monitor's date and time when you accessed it are displayed.</small>	
INPUT MODE	PC3 D-SUB	
SIZE	NORMAL	
COLOR MODE	STD	
BRIGHT	31	
VOLUME	15	
ID No. SET	0	
STATUS	0000-0000-0000-0000	
URL INFORMATION		
RS-232C/LAN SELECT	LAN	
DHCP CLIENT	OFF	
IP ADDRESS	192.168.150.2	
SUBNET MASK	255.255.255.0	
DEFAULT GATEWAY	0.0.0.0	
MONITOR NAME	PNS855	
DATA PORT	10008	
MAC ADDRESS	00-1C-EE-85-C1-74	

6. Specify the “DHCP CLIENT”, “IP ADDRESS”, etc.

SHARP LCD Monitor PN-S855		PN-S855
NETWORK - LAN SETUP		PC3 D-SUB 1920x1080
DHCP CLIENT	ON <input type="radio"/> OFF <input checked="" type="radio"/>	
IP ADDRESS	192   168   150   2	
SUBNET MASK	255   255   255   0	
DEFAULT GATEWAY	0   0   0   0	
DNS SERVER	0   0   0   0 <small>* Please input "0.0.0.0" if you don't use it.</small>	
[Apply]		
RESET	Execute <small>* Settings of LAN (except DNS SERVER) return to initial values.</small>	

### DHCP CLIENT

If your LAN has a DHCP server and you wish to obtain an address automatically, change this setting to “ON”. To set the address manually, set this to “OFF”.

### IP ADDRESS

If the DHCP CLIENT is set to “OFF”, specify an IP address.

### SUBNET MASK

If the DHCP CLIENT is set to “OFF”, specify the subnet mask.

### DEFAULT GATEWAY

If the DHCP CLIENT is set to “OFF”, specify the default gateway. If you are not using a default gateway, specify “0.0.0.0”.

- When the setting is changed, click [Apply].
- Check the message and click [Yes].
- Exit Internet Explorer.
- Restore the PC’s IP address jotted in Step 6, “(2) Specifying the PC’s IP address”.
- Connect the monitor and the PC to the LAN.

### ! Caution

- Wait 10 seconds after clicking [Apply] before proceeding.
- When operating using the remote control unit or similar, click [Refresh].

## Controlling with a PC

### Basic operation

You use Internet Explorer on a PC on the LAN to control the monitor.

- Launch Internet Explorer on the PC.
- In the “Address” box, type “http://” followed by your monitor’s IP address followed by “/”, then press the Enter key.

When prompted to enter a user name and password, type the user name and password that you specified in the security settings (see page 25), and click [OK].

If you did not make any security settings, leave the spaces blank and click on [OK].

- You can check, control, and change the monitor’s status and settings by clicking the menu items on the left side of the screen.

SHARP LCD Monitor PN-S855		PN-S855
INFORMATION		PC3 D-SUB 1920x1080
MODEL	PN-S855	
S/N		
POWER	ON	
DATE/TIME	2008/1/1 TUE 00:45:54 <small>* The monitor's date and time when you accessed it are displayed.</small>	
INPUT MODE	PC3 D-SUB	
SIZE	NORMAL	
COLOR MODE	STD	
BRIGHT	31	
VOLUME	15	
ID No. SET	0	
STATUS	0000-0000-0000-0000	
URL INFORMATION		
RS-232C/LAN SELECT	LAN	
DHCP CLIENT	OFF	
IP ADDRESS	192.168.150.2	
SUBNET MASK	255.255.255.0	
DEFAULT GATEWAY	0.0.0.0	
MONITOR NAME	PNS855	
DATA PORT	10008	
MAC ADDRESS	00-1C-EE-85-C1-74	

- If you see an [Apply] button next to a setting, click it after you change that setting.

### TIPS

- See pages 24 to 28 for details on each setting.
- If you click [Refresh] before the screen finishes updating the current display, the “Server Busy Error” will appear. Wait for a moment before operating your monitor again.
- You cannot operate the monitor while it is warming up.
- If “DHCP CLIENT” is set to “ON”, press  on the remote control unit two times and then check the monitor’s IP address.

# Controlling the Monitor with a PC (LAN)

## ■ INFORMATION

Information about this monitor appears.

SHARP LCD Monitor PN-S655 PN-S655  
PC3 D-SUB  
1920x1080

**INFORMATION**

MODEL	PN-S655
S/N	
POWER	ON
DATE/TIME	2008/1/1 TUE 00:45:54 <small>* The monitor's date and time when you accessed it are displayed.</small>
INPUT MODE	PC3 D-SUB
SIZE	NORMAL
COLOR MODE	STD
BRIGHT	31
VOLUME	15
ID No. SET	0
STATUS	0000-0000-0000-0000
URL INFORMATION	
RS-232C/LAN SELECT	LAN
DHCP CLIENT	OFF
IP ADDRESS	192.168.150.2
SUBNET MASK	255.255.255.0
DEFAULT GATEWAY	0.0.0.0
MONITOR NAME	PNS655
DATA PORT	10008
MAC ADDRESS	00-1C-EE-85-C1-74

Browser Language: English

## ■ CONTROL

You can control the operations corresponding to the buttons (POWER INPUT SIZE) on the remote control unit. (See page 3.)

SHARP LCD Monitor PN-S655 PN-S655  
PC3 D-SUB  
1920x1080

**CONTROL**

POWER	<input checked="" type="radio"/> ON <input type="radio"/> OFF
INPUT MODE	PC3 D-SUB
SIZE	NORMAL
COLOR MODE	STD
BRIGHT	31
VOLUME	15
MUTE	<input type="radio"/> ON <input checked="" type="radio"/> OFF

\* Please click [Refresh] button to check the setting of each item after you change it.

Browser Language: English

## ■ ADJUSTMENT

You can adjust these settings which are also available on the monitor's menu.

- SCREEN (See page 6.)
- PICTURE (See Page 6.)
- PICTURE (ADVANCED) (See Page 6.)
- AUDIO (See page 6.)
- SETUP (See page 7.)
- OPTION (See page 7.)
- SCHEDULE (See page 9.)
- ENLARGE (See page 9.)
- PIP/PbyP (See page 8.)
- FUNCTION (See page 11.)

SHARP LCD Monitor PN-S655 PN-S655  
PC3 D-SUB  
1920x1080

**ADJUSTMENT - SCREEN**

AUTO	<input type="button" value="Execute"/>
CLOCK	600
PHASE	35
H-POS	556
V-POS	22
H-SIZE	60
V-SIZE	60
H-RESOLUTION	1920
V-RESOLUTION	200

\* Settings of the screen adjustment return to initial values.

\* Please click [Refresh] button to check the setting of each item after you change it.

Browser Language: English

## TIPS

- In standby mode, Power ON is the operation available.



## ■ NETWORK (LAN SETUP)

This screen allows you to set the settings necessary when the monitor is connected to a LAN.

SHARP LCD Monitor PN-S655 PN-S655  
PC3 D-SUB PC3 D-SUB  
1920x1080 1920x1080

**NETWORK - LAN SETUP**

DHCP CLIENT  ON  OFF

IP ADDRESS 192 . 168 . 150 . 2

SUBNET MASK 255 . 255 . 255 . 0

DEFAULT GATEWAY 0 . 0 . 0 . 0

DNS SERVER 0 . 0 . 0 . 0  
\* Please input "0.0.0.0" if you don't use it.

Apply

RESET Execute  
\* Settings of LAN (except DNS SERVER) return to initial values.

Refresh

Browser Language English

### DHCP CLIENT

If your LAN has a DHCP server and you wish to obtain an address automatically, change this setting to "ON".  
To set the address manually, set this to "OFF".

### IP ADDRESS

If the DHCP CLIENT is set to "OFF", specify an IP address.

### SUBNET MASK

If the DHCP CLIENT is set to "OFF", specify the subnet mask.

### DEFAULT GATEWAY

If the DHCP CLIENT is set to "OFF", specify the default gateway.  
If you are not using a default gateway, specify "0.0.0.0".

### DNS SERVER

Specify the DNS server address.  
If you are not using a DNS server, specify "0.0.0.0".

### RESET

Clicking [Execute] returns all of the LAN SETUP settings to the factory-preset values except for the DNS SERVER setting.

## ■ NETWORK (SECURITY)

This screen allows you to specify the security-related settings.

SHARP LCD Monitor PN-S655 PN-S655  
PC3 D-SUB PC3 D-SUB  
1920x1080 1920x1080

**NETWORK - SECURITY**

USER NAME [ ] [ ] [ ] [ ]  
\* MAX 8 characters

PASSWORD [ ] [ ] [ ] [ ] [ ] [ ] [ ] [ ]  
\* MAX 8 characters

PASSWORD (CONFIRMATION) [ ] [ ] [ ] [ ] [ ] [ ] [ ] [ ]  
\* Please input the same password once again.

Apply

\* This user name / password is for accessing via Web browser and Telnet.

ACCEPT IP ADDRESS  All IP Addresses  From only specific IP addresses

IP ADDRESS 1 [ ] [ ] [ ] [ ]  
\* Please input "0.0.0.0" if you don't use it.

IP ADDRESS 2 [ ] [ ] [ ] [ ]  
\* Please input "0.0.0.0" if you don't use it.

IP ADDRESS 3 [ ] [ ] [ ] [ ]  
\* Please input "0.0.0.0" if you don't use it.

Apply

Refresh

Browser Language English

### USER NAME / PASSWORD

Sets up a user name and password to restrict access to this monitor.

After entering a user name and password, click [Apply].

### ACCEPT IP ADDRESS

You can limit access to this monitor by registering IP addresses of PCs that should have access.

To limit access, specify the option "From only specific IP addresses". Otherwise, to allow access from any PC, specify "All IP Addresses".

### IP ADDRESS 1 to 3

If "ACCEPT IP ADDRESS" is set to "From only specific IP addresses", enter the IP addresses that you want to allow.

### TIPS

- The USER NAME and PASSWORD can be up to 8 alphanumeric characters or symbols.
- To cancel the user name and/or password after it has been set, make the box empty and click [Apply].

# Controlling the Monitor with a PC (LAN)

## ■ NETWORK (GENERAL)

This screen allows you to specify the general LAN settings.

MONITOR NAME	PN6555 * MAX 16 characters
AUTO LOGOUT TIME	1280 M * from 1 to 65535 If you set 0, this function is disabled.
DATA PORT	10008 * from 1025 to 65535
SEARCH PORT	8005 * from 1025 to 65535

### MONITOR NAME

Specify a name for this monitor as it should appear on the Internet Explorer screen.

### AUTO LOGOUT TIME

Specify the time (in minutes) to elapse before automatically disconnecting this monitor from the network.  
Specify in minutes from 1 to 65535. A value of '0' will disable this function.

### DATA PORT

Specify the TCP port number to use for exchanging data with the monitor.  
Specify a value from 1025 to 65535.

### SEARCH PORT

Specify the port number to use when searching for this monitor.  
Specify a value from 1025 to 65535.

### TIPS

- The MONITOR NAME can be up to 16 alphanumeric characters or symbols.

## ■ MAIL (ORIGINATOR)

This screen allows you to configure the e-mail sent periodically or when the monitor has an error.

The settings depend on the configuration of your LAN. Ask your LAN administrator for details.

SMTP SERVER	<input type="text"/> * MAX 64 characters
ORIGINATOR E-MAIL ADDRESS	<input type="text"/> * MAX 64 characters
ORIGINATOR NAME	<input type="text"/> * MAX 64 characters
AUTHENTICATION	<input type="radio"/> NONE <input type="radio"/> POP before SMTP
POP SERVER	<input type="text"/> No need the setting. * MAX 64 characters
ACCOUNT NAME	<input type="text"/> No need the setting. * MAX 64 characters
PASSWORD	<input type="password"/> * MAX 64 characters

### SMTP SERVER

Specify the SMTP server address for sending e-mail.

- \* When using a domain name, make sure to specify the DNS server as well. (See page 25.)

### ORIGINATOR E-MAIL ADDRESS

Specify the e-mail address for this monitor.  
This address becomes the e-mail address of the originator.

### ORIGINATOR NAME

Specify the name for the originator.  
This name appears in the "Originator Name" field of the e-mail.

### AUTHENTICATION

Specify the authentication method to use when sending e-mail.

### POP SERVER

If the "AUTHENTICATION" method is "POP before SMTP", specify the POP server address.

### ACCOUNT NAME / PASSWORD

If the "AUTHENTICATION" method is "POP before SMTP", specify the account name and password to connect to the POP server.

### TIPS

- You can enter up to 64 alphanumeric characters or symbols for the ORIGINATOR E-MAIL ADDRESS, ORIGINATOR NAME, ACCOUNT NAME, and PASSWORD.
- The SMTP SERVER and POP SERVER can be up to 64 characters.  
The following characters can be used: a-z, A-Z, 0-9, - , .

## MAIL (RECIPIENT)

This screen allows you to specify the recipients of the e-mail sent periodically or when the monitor has an error.

### RECIPIENT E-MAIL ADDRESSES

Specify the e-mail addresses to send error notification e-mail to.

### CONDITION

Specify the conditions to send mails.  
When you check PERIODICAL, specify the date and time to send the mails in the PERIODICAL setting.

### CONFIRMATION

Sends test e-mail.  
This allows you to confirm that the e-mail settings are configured properly.

### Attach the log file to a TEMPERATURE/HARDWARE error e-mail

When this option is checked, a log is added to the mail which notifies a temperature or status error.

### TIPS

- The RECIPIENT E-MAIL ADDRESSES can be up to 64 alphanumeric characters or symbols.

## MAIL (PERIODICAL)

When PERIODICAL for CONDITION of MAIL (RECIPIENT) is checked, set the date and time to send the mail.

### DAY OF THE WEEK

Specify the day of the week to send the periodical mails.

### TIME

Specify the time of the day to send the periodical mails.

### ! Caution

- Do not turn off the main power when you set to send the periodical mails.
- Specify the correct date and time. (See page 7.)  
If the date and time settings are incorrect, the periodical mail is not sent properly.
- Regularly confirm that the specified date and time is correct.

## Controlling the Monitor with a PC (LAN)

### ■ SERVICE & SUPPORT (URL INFORMATION)

You can display a specific URL in the URL INFORMATION field on the INFORMATION screen when an error occurs in the monitor. (See page 24.)

URL INFORMATION * MAX 64 characters	CONDITION			CONFIRMATION
	ALWAYS	TEMPERATURE	HARDWARE	
<input type="text"/>	<input type="checkbox"/>	<input type="checkbox"/>	<input type="checkbox"/>	<input type="button" value="Test"/>

Browser Language:

#### URL INFORMATION

Enter a URL to display when an error occurs on the monitor. Up to 64 alphanumeric characters or symbols can be used.

#### CONDITION

Specify the condition to display the URL.

#### CONFIRMATION

The home page of the specified URL is displayed. You can check whether the URL you entered is correct.

#### TIPS

- It is also possible to specify the message text, such as the name of a contact or a telephone number, to be displayed instead of the linked URL.

# MEMO

**SHARP**<sup>®</sup>  
SHARP CORPORATION