

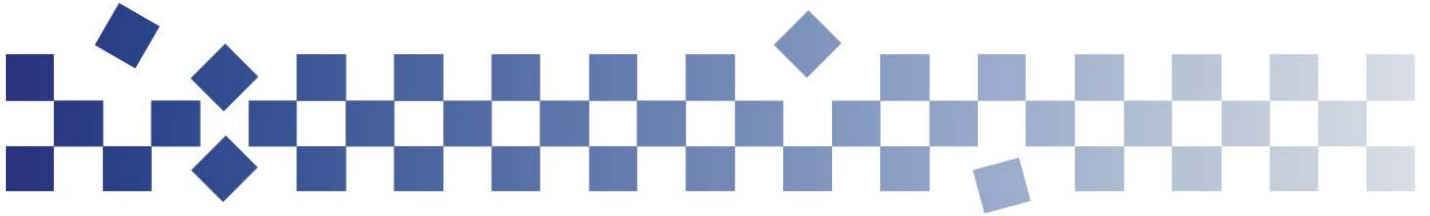

SOYO

M17GS

17" TFT
LCD MONITOR



Getting Start

Table of content	1
View of Monitor.....	2
Unpacking	3
Warning	3
Hardware Installation.....	4
Hardware Installation Step by Step.....	5
Menu control button.....	6
Key introduction.....	6
Cleaning Notices	7
Precaution	7
Troubleshooting.....	7
OSD (On-Screen Display) Menu Mode	8-9
Display Mode.....	10
Specification	10-11





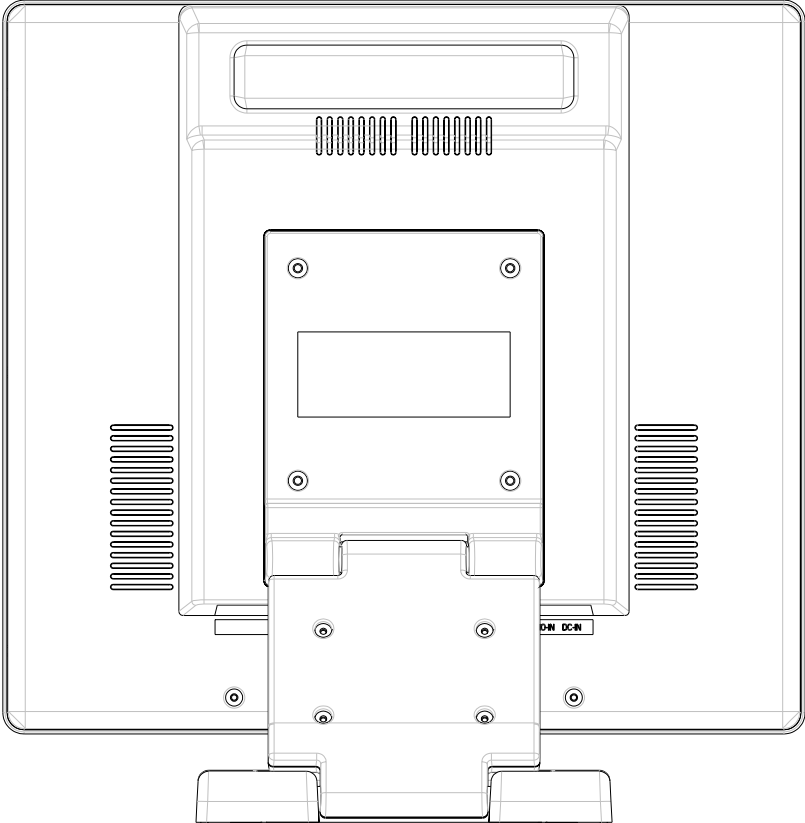
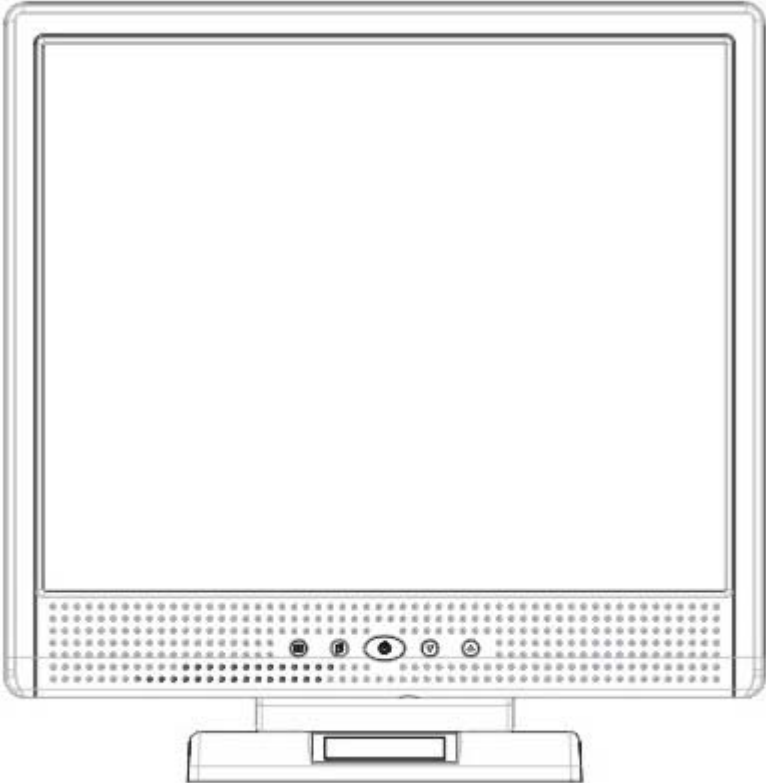

All Information in this manual may change from time to time without prior notice.

View of Monitor

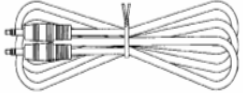
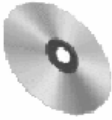

Unpacking

Our 17" LCD monitor shall be content with these following items. Make sure you get all these set ready, otherwise contact to your dealer or store which you purchased it. At last, feel free to contact us.

<p>17" TFT LCD Monitor</p>			
<p>External Univ15 pin D-sub (RGB Analog) input signal cable</p>		<p>Power Cord</p>	
<p>ADAPTER TECH. External Universal AC Adaptor STD-1203 (100-240V, 50/60Hz)</p>		<p>Audio connector : stereo Phone Jack</p>	
<p>CD User's manual</p>		<p>Quick Start Guide</p>	
<p>DVI cord *</p>			

* DVI function is optional.

Warning

1. Make sure that the system power is turned off.
2. Plug the signal cable to the signal connector at the rear of PC.
3. Plug adapter output cable to the jack at the rear of LCD monitor and the power cord to the adapter.
4. Connect the power cord to power source.
5. Turn on the computer and the monitor.
6. For the best quality of the performance, we suggest you to set resolution as page 10 (Display Mode).

Hardware Installation

Be carefully to your LCD monitor, it's very exquisite but easy to broken. Turn off LCD's and PC's power before you set it up. Follow our installation step by step.

Input

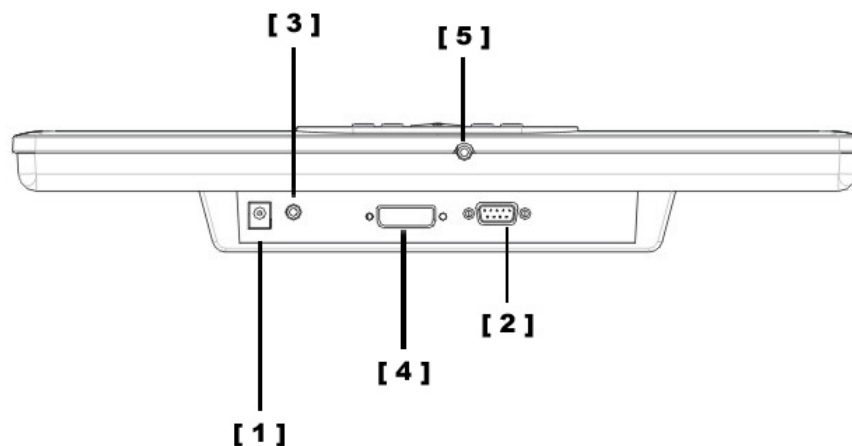
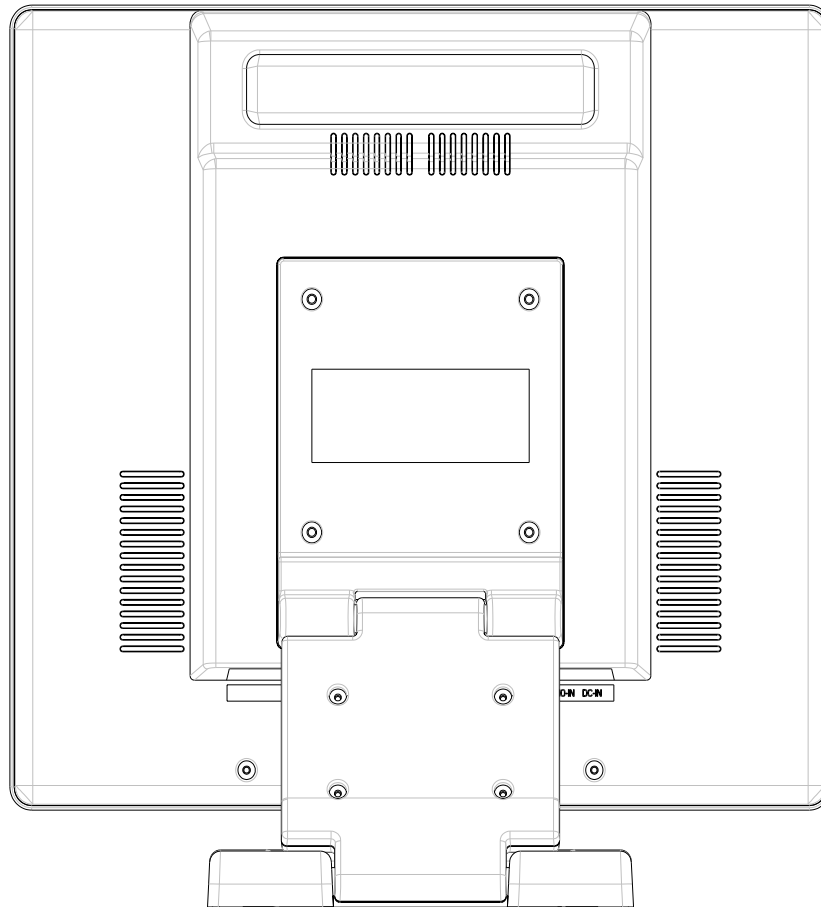

- [1] DC port :** This is for connecting the power cable.
- [2] PC In :** This can be connected with the D-Sub 15 pin signal Cable.
- [3] LINE in :** This can be connected to the audio-out connector of any sound resource.
- [4] DVI port :** This can be connected with the DVI signal Cable.
- [5] Earphone jack :** This is for connecting the earphone.

Hardware Installation Step by Step

1. Turn your LCD opposite carefully which can see all the connection port.
2. Inset the signal cable such as RGB analog (standard) to its own port, and the other side connects to computer.



3. Inset the Audio connector to its own port, and the other side connects to computer line out.



4. Put AC Adaptor and Power Cord together.



5. Inset the DC cable to its own port (DC in), and the other side connect to socket.



6. Congratulations you had done with it. You can enjoy the excellent performance.

Monitor Adjusting

Menu control button

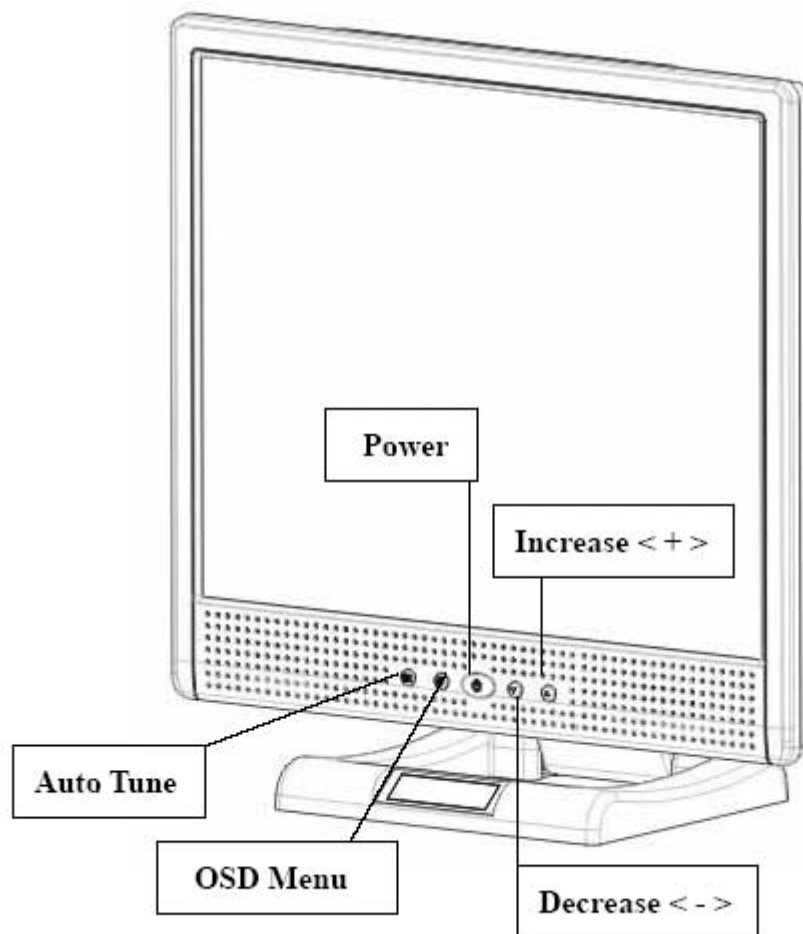

Key introduction

Power: Turn the LCD power on and off. When the power is on, the light is showing green, stand by will be orange.

OSD Menu: Press the button to OSD menu, menu right adjustment.

Auto Tune: Auto adjust, menu left adjustment.

Decrease <->: Decrease the option value in the OSD menu.

Increase <+>: Increase the option value in the OSD menu.

Cleaning Notice

1. Be gentle to clean the screen.
2. Never, ever, using any kind of corrosiveness chemical dissolvent to clean the screen, it may hurt your screen surface.
3. We suggest that using a clean camel hair brush or a soft, clean, lint-free cloth to wipe the screen.
4. Don't give any pressure directly to the LCD

Precaution

1. Do not expose the monitor to direct sunlight or heat.
2. Do not spill liquid on the monitor.
3. Do not attempt to open the monitor. You may be hurt by electric shock. For service, call your place of purchase.
4. Do not use your monitor when magnets or electronic products are operating nearby.
5. Do not use harsh chemicals or strong cleaning solvents to clean the monitor screen. Wipe it with clean, soft clothes applied with mild solution.
6. Do not place anything on your monitor. Bad ventilation may elevate temperature in the monitor.
7. Don't use your fingers to touch the LCD Screen, directly. Fingerprint that contains oil and may be difficult to clear.

Troubleshooting

Make sure that your monitor is properly installed if you have encountered any trouble using this product.

· There is no picture on the screen.

Check:

1. Power saving mode. Press any key and move the mouse to deactivate the mode.
2. Signal cable connector pins. If there are bent or missing pins, consult your place of purchase.

· Characters look too dark or too light

Check:

1. Using OSD Menu to adjust the Brightness.

· When your monitor shall be Adjusted?

Check:

1. If the resolution or frequency is being changed.

· The Text appears on the screen are unclear.

Check

1. Make sure the resolution or refresh rate match with the Display Mode.

OSD (On-Screen Display) Menu Mode

Option select

1. Press the OSD button to access menu.
2. Using Auto Tune for left adjustment.
3. Press OSD again for right adjustment.



Brightness:
Adjust the brightness of the display.



Main menu brightness adjust



Contrast :
Adjust the difference between light and dark area.

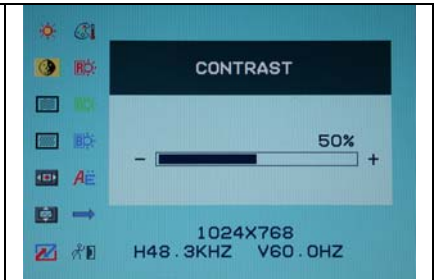

Main menu contrast adjust



Phase :
Adjust the phase of PLL.



Main menu phase adjust



Clock :
Adjust the frequency of the PLL.

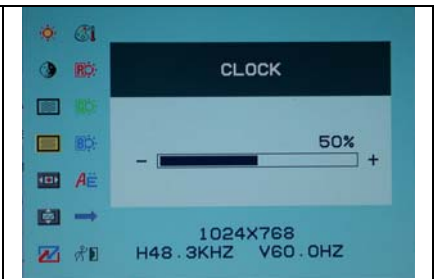

Main menu clock adjust



Horizontal Position :
Adjust the horizontal position of the display.

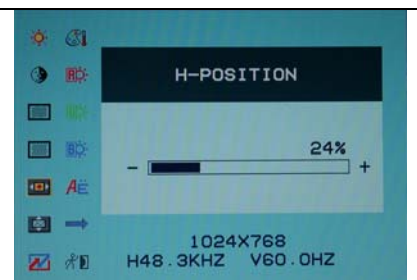

Main menu H position adjust



Vertical Position :
Adjust the vertical position of display.

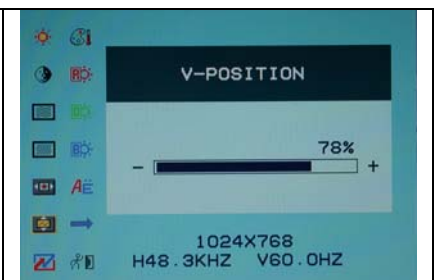

Main menu V position adjust



Reset :
Recall the default setting.

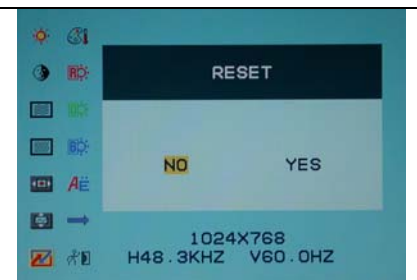

Main menu Reset



Color Temp :
Adjust the color Temperature.



Main menu color temp. adjust



Language :
Language support.



Main menu language adjust



Miscellaneous :



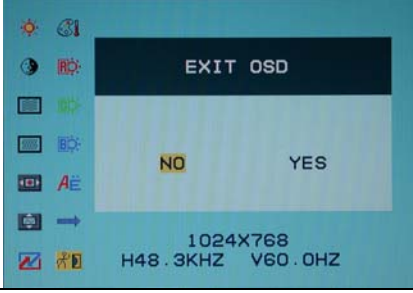

Main menu miscellaneous adjust

<p> EXIT : Saving and Leave.</p>	 <p>Main menu EXIT adjust</p>
--	---

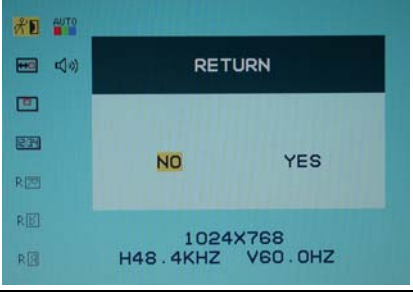
Miscellaneous

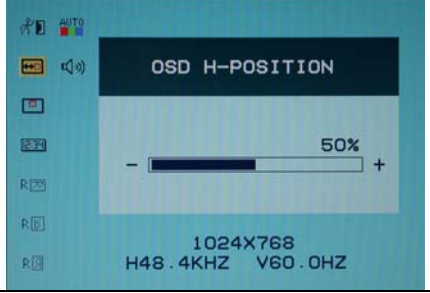
<p> Return : Return to main menu.</p>	 <p>Return</p>
---	---

<p> Horizontal Position : Adjust the horizontal position of the OSD.</p>	 <p>OSD H position adjust</p>
--	--

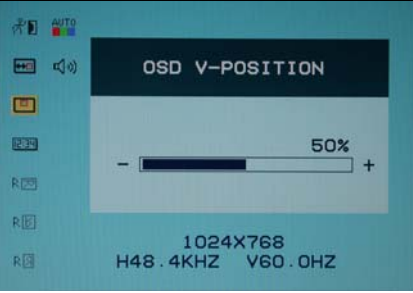
<p> Vertical Position : Adjust the vertical position of the OSD.</p>	 <p>OSD V position adjust</p>
---	---

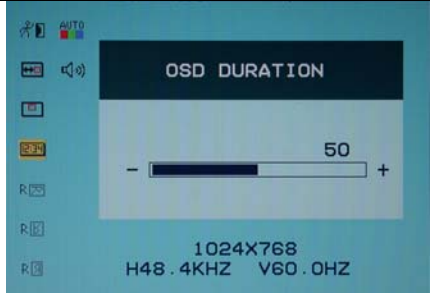
<p> OSD Duration : Adjust the timing of the OSD menu.</p>	 <p>OSD duration adjust</p>
---	---

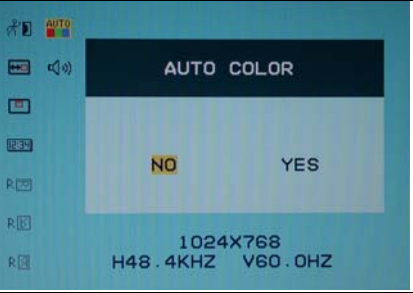
<p> Auto color : Adjust the color automatically.</p>	 <p>Auto color adjust</p>
--	--

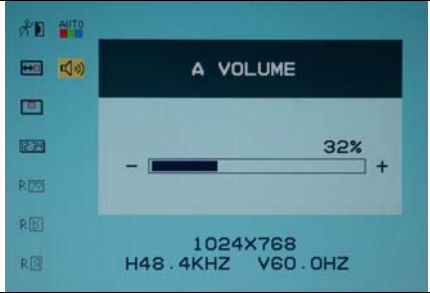
<p> Volume : Adjust of speaker.</p>	 <p>Menu Volume adjust</p>
---	---

DISPLAY MODE

Incoming Display Mode		
Resolution	Horizontal Frequency (KHz)	Vertical Frequency (Hz)
640X350	31.475	70.100
640X480	31.469	59.940
640X480	37.500	75.000
720X400	31.469	70.087
800X600	37.879	60.317
800X600	46.875	75.000
1024X768	48.363	60.004
1024X768	60.023	75.029
1280X1024	63.981	60.020
1280X1024	79.976	75.024

1. We offer you 8 available modes compatible with Windows.
2. If any interference occurs on your screen while you modulating your PC or OSD. It is normal.
3. To have Best quality present on the PC, remember to upgrade your video card Driver. We strongly recommend you to choose a Mode listed in the table.
4. The other Modes may not be supported that are not list on the table above
5. You may use the power management on your computer. It's good for last service life of the product.

Specification

LCD Panel	Type Viewing Angle Contrast Ratio Brightness Response Time(Tr+Tf) Display Colors Max Resolution Pixel Pitch	17.0" TFT Active Matrix LCD Display H:140° , V:140° 450 : 1 (Typical) 260 cd/m ² (Typical) (14+2) 16 ms 16.7M colors(True color) 1280X1024(SXGA) 0.264mm(H)x0.264mm(V)
Input Signals	RGB Analog DVI*	Video Level:0.7Vp-p(75Ω) Sync TTL with 75Ω internal pull-up resistors Frequency FH:30~79KHz FV:56~75Hz Support digital RGB signal with TMDS signaling type
Compatibility	PC	Up to 1280X1024@75Hz(Non-interlaced)
Connector	RGB Analog Audio Power	D-sub 15-pins Stereo Phone Jack, RCA-Jack(L/R)* 12V/DC Power Jack
Power	Voltage Consumption Power saving mode	100-240V, 50/60Hz(universal) via external AC Adapter Active < 48 Watt Max Standby < 3 Watt
Internal Speaker		2Wx2(Stereo)
User Interface	LED Indicator	Active - Green Standby - Orange Off - Turn off
Operating Condition	Temperature Air Humidity	5°C~40°C 20% ~ 80% R.H.
Dimensions (W x H x D)	Physical	377.8mm(W) x 385.9mm(H) x 53.5mm(D)

Net Weight		4.0 Kg
DDC		DDC1/DDC2B Compliant
Power Management		VESA DPMS, EPA Energy Star
Regulation (Certifications)		CE, FCC, VCCI, UL/CUL,BSMI

* DVI function is optional.