

SERVICE MANUAL

BG-3S CHASSIS

MODEL COMMANDER DEST. CHASSIS NO. MODEL

COMMANDER DEST. CHASSIS NO.

KV-HF21M80 *RM-952* *Vietnam* *SCC-U28EA-A*

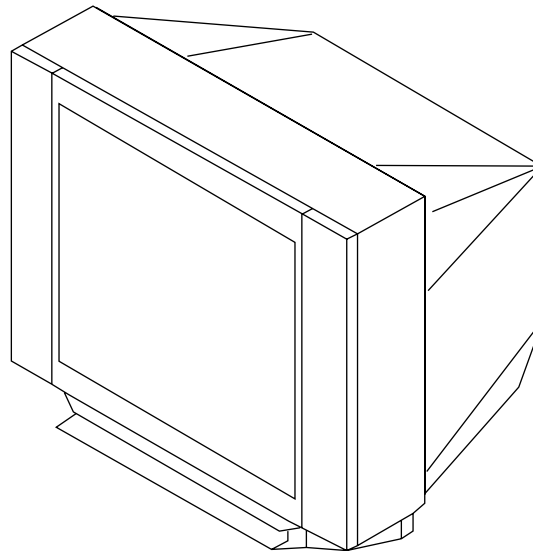

TRINITRON® COLOR TV
SONY®

SPECIFICATIONS

		Note
Power requirements	110-240 V AC, 50/60 Hz	
Power consumption (W)	Indicated on the rear of the TV	
Television system	B/G, I, D/K, M	
Color system	PAL, PAL 60, SECAM, NTSC4.43, NTSC3.58	
Channel coverage		
B/G	VHF: E2 to E12 / UHF: E21 to E69 / CATV: S01 to S03, S1 to S41	
I	UHF: B21 to B68 / CATV: S01 to S03, S1 to S41	
D/K	VHF: C1 to C12, R1 to R12 / UHF: C13 to C57, R21 to R60 CATV: S01 to S03, S1 to S41, Z1 to Z39	
M	VHF: A2 to A13 / UHF: A14 to A79 / CATV: A-8 to A-2, A to W+4, W+6 to W+84	
⏏ (Antenna)	75-ohm external terminal	
Audio output	5W + 5W	
Number of terminal		
📺 (Video)	Input: 2 Output: 1	Phono jacks; 1 V _{P-P} , 75 ohms
🎵 (Audio)	Input: 2 Output: 1	Phono jacks; 500 mV _{rms}
🎧 (Headphone)	Output: 1	Minijack
Picture tube	21 inch	
Tube size (cm)	54	Measured diagonally
Screen size (cm)	51	Measured diagonally
Dimension (w/h/d, mm)	640 × 456 × 488	
Mass (kg)	27	

Design and specifications are subject to change without notice.

CAUTION

SHORT CIRCUIT THE ANODE OF THE PICTURE TUBE AND THE ANODE CAP TO THE METAL CHASSIS, CRT SHIELD, OR CARBON PAINTED ON THE CRT, AFTER REMOVING THE ANODE.

SAFETY-RELATED COMPONENT WARNING!!

COMPONENTS IDENTIFIED BY SHADING AND MARK \triangle ON THE SCHEMATIC DIAGRAMS, EXPLODED VIEWS AND IN THE PARTS LIST ARE CRITICAL TO SAFE OPERATION. REPLACE THESE COMPONENTS WITH SONY PARTS WHOSE PART NUMBERS APPEAR AS SHOWN IN THIS MANUAL OR IN SUPPLEMENTS PUBLISHED BY SONY.

TABLE OF CONTENTS

<u>Section</u>	<u>Title</u>	<u>Page</u>	<u>Section</u>	<u>Title</u>	<u>Page</u>
	SELF DIAGNOSIS FUNCTION	4	5. DIAGRAMS		
1. GENERAL		8	5-1. Block Diagram		37
2. DISASSEMBLY			5-2. Frame Schematic Diagram		40
2-1. Rear Cover Removal		19	5-3. Circuit Boards Location		42
2-2. Chassis Assy Removal		19	5-4. Schematic Diagrams and Printed Wiring Boards ...		43
2-3. F Bracket Removal		19	(1) Schematic Diagram of A (1/2) Board		45
2-4. Service Position		19	(2) Schematic Diagram of A (2/2) Board		48
2-5. Replacement of Parts		20	(3) Schematic Diagram of C3 Board		54
2-5-1. Replacement of Control Button		20	(4) Schematic Diagram of F Board		57
2-5-2. Replacement of Light Guide		20	5-5. Semiconductors		59
2-6. Terminal Bracket Removal		20	6. EXPLODED VIEW		
2-7. Degauss Coil Removal		20	6-1. Chassis		61
2-8. Picture Tube Removal		21	7. ELECTRICAL PARTS LIST		63
3. SET-UP ADJUSTMENTS					
3-1. Beam Landing		22			
3-2. Convergence		23			
3-3. Focus Adjustment		25			
3-4. G2 (Screen) and White Balance Adjustments		25			
4. CIRCUIT ADJUSTMENT					
4-1. Adjustments with Commander		26			
4-2. Adjustment Method		27			
4-3. Picture Quality Adjustments		32			
4-4. A Board Adjustment After IC003 (Memory) Replacement		32			
4-5. Picture Distortion Adjustment		33			

SELF DIAGNOSTIC FUNCTION

The units in this manual contain a self-diagnostic function. If an error occurs, the STANDBY/TIMER lamp will automatically begin to flash.

The number of times the lamp flashes translates to a probable source of the problem. A definition of the STANDBY/TIMER lamp flash indicators is listed in the instruction manual for the user's knowledge and reference. If an error symptom cannot be reproduced, the remote commander can be used to review the failure occurrence data stored in memory to reveal past problems and how often these problems occur.

1. DIAGNOSTIC TEST INDICATORS

When an errors occurs, the STANDBY/TIMER lamp will flash a set number of times to indicate the possible cause of the problem. If there is more than one error, the lamp will identify the first of the problem areas.

Result for all of the following diagnostic items are displayed on screen. No error has occurred if the screen displays a "0".

Diagnostic Item Description	No. of times STANDBY/TIMER lamp flashes	Self-diagnostic display/Diagnostic result	Probable Cause Location	Detected Symptoms
• Power does not turn on	Does not light	—	<ul style="list-style-type: none"> • Power cord is not plugged in. • Fuse is burned out F4601 (F) 	<ul style="list-style-type: none"> • Power does not come on. • No power is supplied to the TV. • AC power supply is faulty.
<ul style="list-style-type: none"> • +B overcurrent (OCP) or overvoltage (OVP) • Vertical deflection stopped • Horizontal deflection overdrive 	2 times	002:000 or 002:001~255 003:001~255 004:001~255 at the same time	<ul style="list-style-type: none"> • H.OUT Q511 is shorted. (A board) • IC1800 is shorted. (C3 board) • -13V is not supplied. (A board) • IC 503 faulty (A board) • IC 301 faulty (A board) 	<ul style="list-style-type: none"> • Power does not come on. • Load on power line is shorted. • Has entered standby state after horizontal raster. • Vertical deflection pulse is stopped. • Power line is shorted or power supply is stopped.
• White balance failure (no PICTURE)	5 times	005:000 or 005:001~225	<ul style="list-style-type: none"> • G2 is improperly adjusted. (Note 2) • CRT problem. • Video OUT IC1800 is faulty. (C3 board) • IC301 is faulty. (A board) • No connection A board to C3 board. 	<ul style="list-style-type: none"> • No raster is generated. • CRT cathode current detection reference pulse output is small.
• Micro reset	—	101:00 or 101:001~225	<ul style="list-style-type: none"> • Discharge CRT (C3 Board) • Static discharge • External noise 	<ul style="list-style-type: none"> • Power is shut down shortly, after this return back to normal. • Detect Micro latch up.

Note 1: If a + B overcurrent is detected, stoppage of the vertical deflection is detected simultaneously.

The symptom that is diagnosed first by the microcontroller is displayed on the screen.

Note 2: Refer to screen (G2) Adjustment in section 3-4 of this manual.

2. DISPLAY OF STANDBY/TIMER LIGHT FLASH COUNT

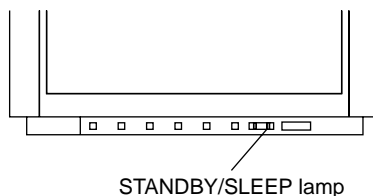
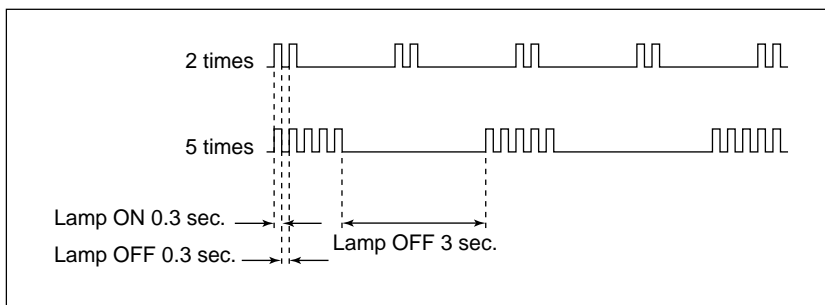

<u>Diagnostic Item</u>	<u>Flash Count*</u>
+B overcurrent/overvoltage Vertical deflection stopped	2 times
White balance failure	5 times

* One flash count is not used for self-diagnostic.

3. STOPPING THE STANDBY/TIMER FLASH

Turn off the power switch on the TV main unit or unplug the power cord from the outlet to stop the STANDBY/TIMER lamp from flashing.

4. SELF-DIAGNOSTIC SCREEN DISPLAY

For errors with symptoms such as “power sometimes shuts off” or “screen sometimes goes out” that cannot be confirmed, it is possible to bring up past occurrences of failure for confirmation on the screen:

[To Bring Up Screen Test]

In standby mode, press buttons on the remote commander sequentially in rapid succession as shown below:

Screen display → channel [5] → Sound volume [0] → Power ON
↑

Note that this differs from entering the service mode (mode volume [+]).

Self-Diagnosis screen display

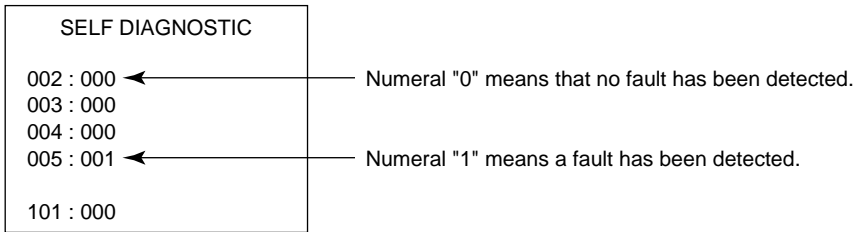

5. HANDLING OF SELF-DIAGNOSTIC SCREEN DISPLAY

Since the diagnostic results displayed on the screen are not automatically cleared, always check the self-diagnostic screen during repairs. When you have completed the repairs, clear the result display to “0”.

Unless the result display is cleared to “0”, the self-diagnostic function will not be able to detect subsequent faults after completion of the repairs.

[Clearing the result display]

To clear the result display to “0”, press buttons on the remote commander sequentially as shown below when the diagnostic screen is being displayed.

Channel [8] → 0

[Quitting Self-diagnostic screen]

To quit the entire self-diagnostic screen, turn off the power switch on the remote commander or the main unit.

6. SELF-DIAGNOSTIC CIRCUIT

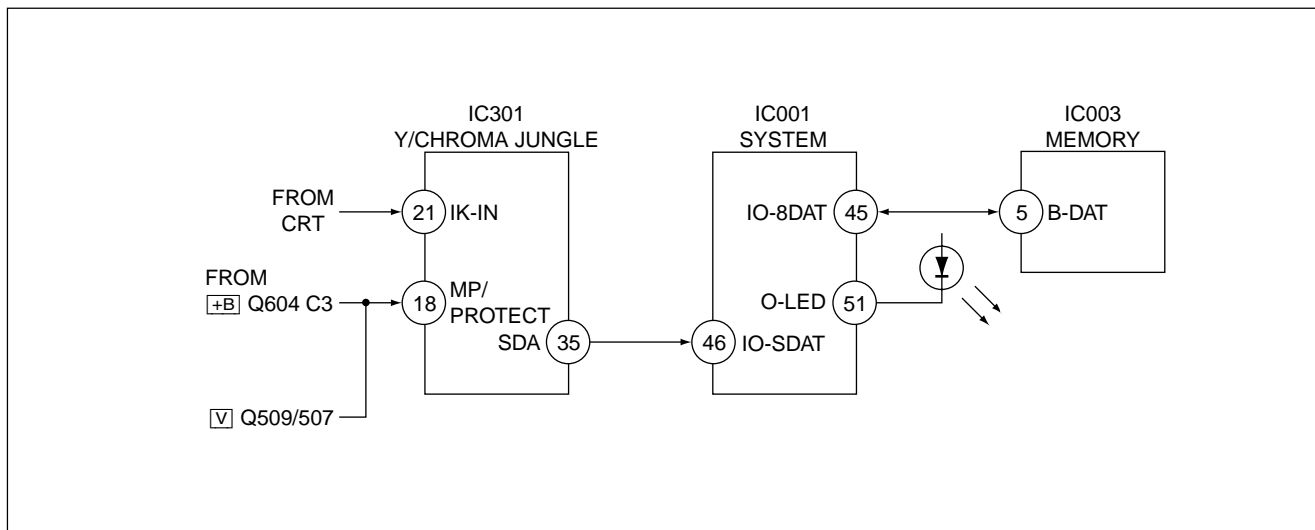

+B overcurrent (OCP)

Occurs when an overcurrent on the +B(135) line is detected by Q604. If Q604 go to ON and the voltage to pin 18 of IC301 should go down when V.SYNC is more than seven verticals in a period, the unit will automatically turn off.

Vertical deflection stopped

Occurs when an absence of the vertical deflection pulse is detected by Q509 and IC001 shut down the power supply.

Vertical deflection overcurrent

Occurs when an overcurrent on V drive line is detected by Q507. Power supply will be shut down when detect this by IC001.

White balance failure

If the RGB levels* do not balance or become low level within 5 seconds, this error will be detected by IC301. TV will stay on, but there will be no picture.





* (Refers to the RGB levels of the AKB detection Ref pulse that detects IK.)

The operating instructions mentioned here are partial abstracts from the Operating Instruction Manual. The page numbers of the Operating Instruction Manual remain as in the manual.

SECTION 1 GENERAL

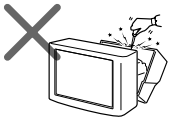
WARNING

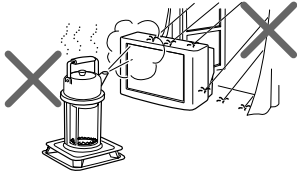
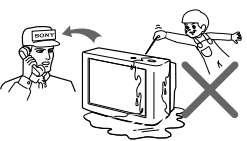
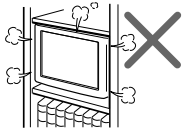
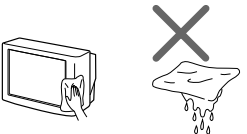
- Dangerously high voltages are present inside the TV.
- Operate the TV only between 110 – 240 V AC.

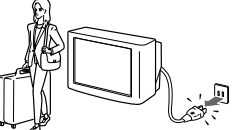
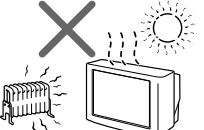
 <p>Do not open the cabinet and the rear cover of the TV. Refer servicing to qualified personnel.</p>	 <p>Install the TV in a stable position. Do not allow children to climb onto it.</p>
 <p>To prevent fire or shock hazard, do not expose the TV to rain or moisture.</p>	 <p>Do not operate the TV if any liquid or solid object falls into it. Have it checked immediately by qualified personnel only.</p>
 <p>Do not install the TV in a confined space, such as a bookcase or built-in cabinet. Do not block the ventilation openings of the TV.</p>	 <p>Clean the TV with a dry and soft cloth. Do not use benzene, thinner, or any other chemicals to clean the TV. Do not scratch the picture tube.</p>
 <p>Do not pull the power cord to disconnect the TV. Pull it out by the plug.</p>	 <p>Do not plug in too many appliances to the same power socket. Do not damage the power cord.</p>
 <p>Disconnect the power cord if you are not going to use the TV for several days.</p>	 <p>Do not install the TV in hot, humid or excessively dusty places.</p>

Using Your New TV

Getting Started

Step 1

Connect the antenna

If you wish to connect a VCR, see the "Connecting a VCR" diagram below.

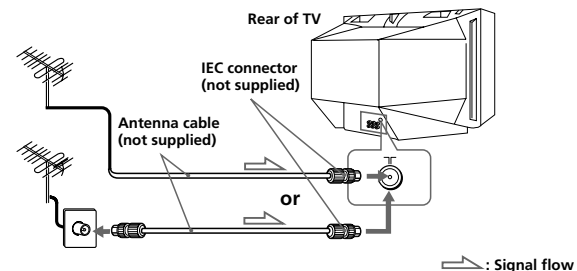

Connecting a VCR

To watch the video, press  (see page 13).

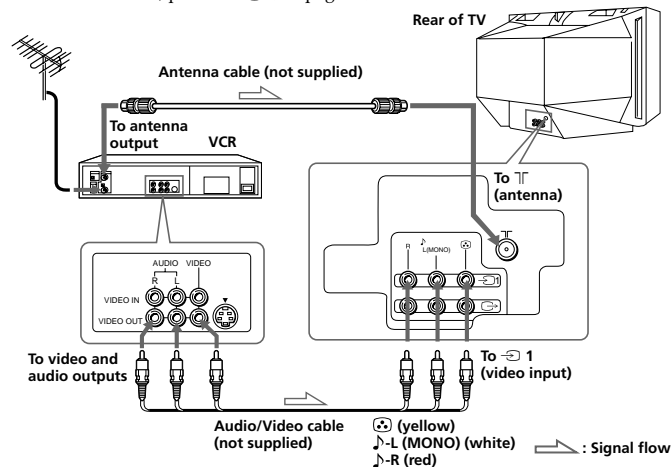

Notes

- If you connect a monaural VCR, connect the yellow plug to Ⓜ (the yellow jack) and the black plug to J-L (MONO) (the white jack).
- If you connect a VCR to the Ⓜ (antenna) terminal, preset the signal output from the VCR to the program number 0 on the TV.
- When no signal is input to the connected video equipment, the TV screen becomes blue.

CAUTION

Do not connect the power cord until you have completed making all other connections; otherwise a minimum leakage current might flow through the antenna and other terminals to ground.

Step 2

Insert the batteries into the remote

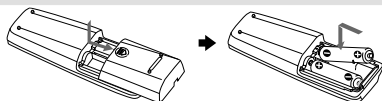

Note

- Do not use old batteries nor use different types of batteries together.

Step 3

Preset the channels automatically

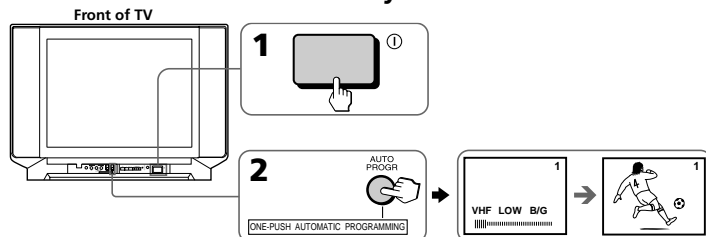

Tips

- If you want to stop automatic channel presetting, press SELECT twice.
- If your TV has preset an unwanted channel or cannot preset a particular channel, then preset your TV manually (see page 10).

Note

- During automatic channel presetting, your TV screen will indicate "B/G", "I", "D/K" or "M" for the TV system ("TV SYS").

Now You Are Ready. . .

To watch your TV, see page 12.

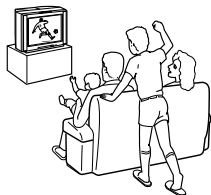

Connecting the 3D WOOFER

You can enjoy high quality sound by connecting the 3D WOOFER.

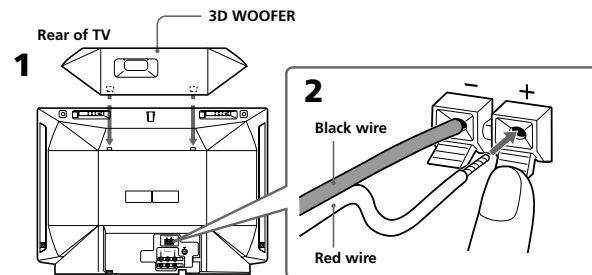

1 Attach the 3D WOOFER into the footholds on the top of your TV.

2 Connect the wires to the 3D WOOFER (8 Ω) terminals at the rear of your TV. The red wire should be connected to the \oplus red terminal and the black wire to the \ominus black terminal.

Notes

- Connect only the supplied 3D WOOFER; otherwise your TV may malfunction.
- Unplug your TV from the wall outlet when connecting the 3D WOOFER.
- To prevent a malfunction caused by a short circuit of the terminals, make sure that none of the 3D WOOFER wire strands stick out, making contact with the neighbouring speaker terminal.

Connecting optional components

You can connect optional audio/video components, such as a VCR, multi disc player, camcorder, video game or stereo system.

To watch the picture of the connected equipment, press (see page 13).

Connecting a camcorder/video game equipment using the 2 (video input) jacks

Front of TV

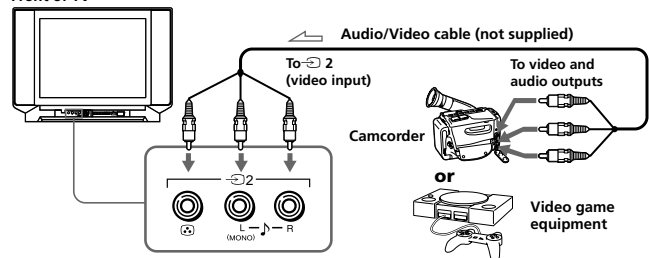

Note

- You can also connect video equipment to the 1 (video input) jacks at the rear of your TV.

Connecting audio/video equipment using the (monitor output) jacks

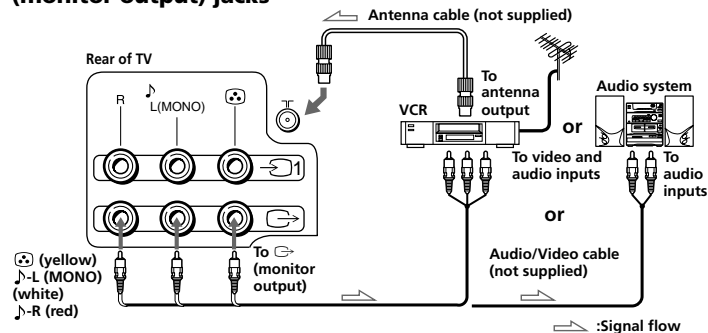

Note

- When connecting a monaural VCR, connect the yellow plug to (the yellow jack) and the black plug to L (MONO) (the white jack).

Using Your New TV

Securing the TV

To prevent the TV from falling, secure the TV using one of the following methods:

- A** With the supplied screws, attach the band to the TV stand and to the rear of the TV using the provided hole.

or

- B** Put the cord or chain through the clamps to secure the TV against a wall or pillar.

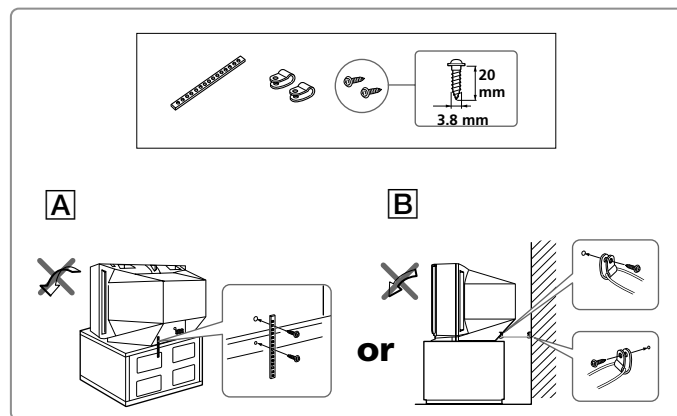

Presetting channels

You can preset up to 100 TV channels in numerical sequence from program number 1 using the remote and the buttons on your TV as well.

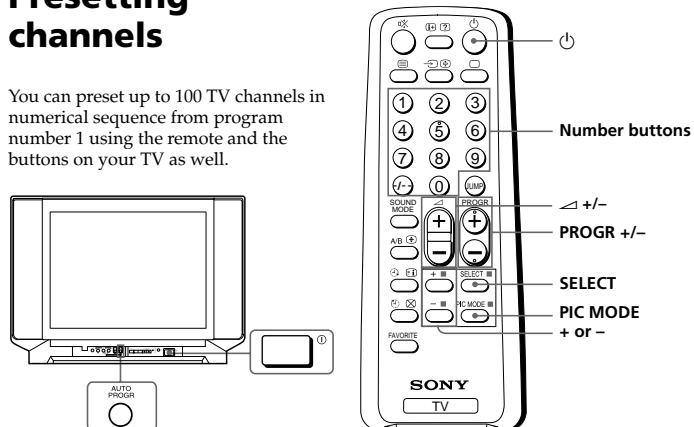

Presetting channels automatically

- 1 Press ① to turn on the TV.



- 2 Press AUTO PROGR.



Note

- During automatic channel presetting, your TV screen will indicate "B/G", "I", "D/K" or "M" for the TV system ("TV SYS").

To preset channels automatically from a specified program number

- (1) Press SELECT until "AUTO PROGRAM" appears.
- (2) Press + or -.
The on-screen display will start flashing.
- (3) Press PROGR +/- or the number buttons until the desired program number appears.
- (4) Press + or -.

continued

Presetting channels (continued)

Presetting channels manually

- 1 Press SELECT until "MANUAL PROGRAM" appears.



- 2 Press + or -.



- 3 Press PROGR +/- or the number buttons until the desired program number appears.

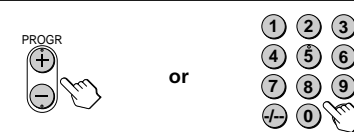

- 4 Press + or - until the desired channel picture appears.

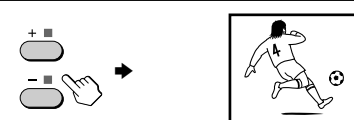

- 5 Press SELECT.



To change the TV system setting

If the picture or sound is abnormal when receiving programs through the ㄗ (antenna) terminal

- (1) Press SELECT until "TV SYS" appears.



- (2) Press + or - to select the appropriate TV system until the picture or sound quality is optimal.

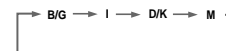

To change the color system setting

If the color is abnormal when receiving programs through the ㊄ (antenna) terminal or the ㊄ (video input) jack

- Press SELECT until "COL SYS" appears.



- Press + or - to select the appropriate color system until the color is optimal.

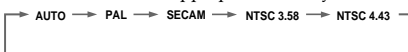

Tip

- Normally set "COL SYS" to "AUTO".

Skipping program numbers

- Press PROGR +/- or the number buttons until the unused or unwanted program number appears.
- Press SELECT until "MANUAL PROGRAM" appears.
- Press + or -.
- Press PIC MODE.
- Press SELECT.

To preset the skipped program number again

Preset the channel automatically or manually.

Tip

- You can also use SELECT and ㄤ +/- on the TV to preset channels and skip program numbers.

To use the fine tuning (FINE) function

The fine tuning (FINE) function may help to reduce the following problems: double images and lines moving across the TV screen.

You can use the fine tuning function as below:

- Select the program number you want to adjust.
- Press SELECT until "MANUAL PROGRAM" appears on the screen.
- Press + or - on the remote control once.
- Press ㊄ ㊄ to display "FINE" on the screen.
- Press + or - continuously until the above problems are minimized. The + or - icon on the screen flashes while tuning.
- Press SELECT to return to normal screen.

Using Your New TV

Watching the TV

This section explains functions used while watching the TV. Most operations can be done using the remote.

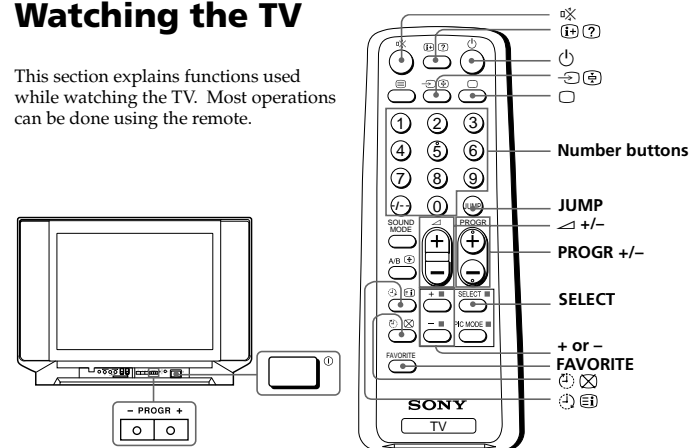

- Press ㊄ to turn on the TV.

When the TV is in the standby mode (the ㊄ indicator on the TV is lit red), press ㊄ on the remote or PROGR +/- on the TV.



- Press PROGR +/- or the number buttons to select the TV program.

For double digit numbers, press +/-, then the number (e.g., for 25, press +/-, then 2 and 5).

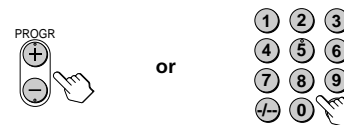

- Press ㄤ +/- to adjust the volume.



Additional tasks

To	Do this
Turn off temporarily	Press . The on the TV lights up red.
Turn off completely	Press on the TV.
Mute the sound	Press .
Watch the video input (VCR, camcorder, etc.)	Press to select "VIDEO 1" or "VIDEO 2". To return to the TV program, press .
Jump back to the previous channel	Press JUMP.
Display the on-screen information*	Press .
Adjust the volume of each TV program automatically	Press SELECT repeatedly until "INTELLIGENT VOL" appears, then press + or - to select "ON". To cancel, select "OFF".
Adjust the picture position when it is not aligned to the TV screen (KV-XF21M83/XF21M80 only)	Press SELECT repeatedly until "PIC ROTATION" appears, then press + or - to adjust the alignment of the picture position.

PIC ROTATION

The or icon on the screen flashes while adjusting.

* The picture, sound, and either the program number or video mode are displayed. The on-screen display for the picture and sound information disappears after about 3 seconds.

Changing the on-screen display language

- 1 Press SELECT until "LANGUAGE / 语言: ENGLISH" appears on the screen.



- 2 Press + or - to select "中文".



Tip

- You can also use SELECT and / on the TV to select the on-screen display language.

continued

Watching the TV (continued)

Setting the Wake Up timer

- 1 Press until the desired period of time appears.

The Wake Up timer starts immediately after you have set it.

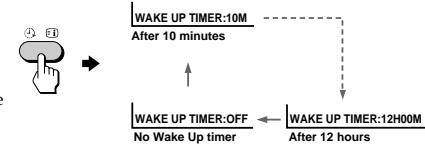

- 2 Select the TV program or video mode you want to display when you wake up.
- 3 Press or set the Sleep timer if you want the TV to turn off automatically.

The on the TV lights up orange.

To cancel the Wake Up timer

Press until "WAKE UP TIMER: OFF" appears or turn off the TV's main power.

Note

- If no buttons or controls are pressed for more than two hours after the TV is turned on using the Wake Up timer, the TV automatically goes into the standby mode. To continue watching the TV, press any button or control on the TV or the remote.

Setting the Sleep timer

Press until the desired period of time appears.

The Sleep timer starts immediately after you have set it.

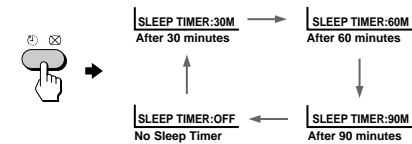

To cancel the Sleep timer

Press until "SLEEP TIMER: OFF" appears or turn the TV off.

Advanced Operations

Customizing the picture and sound

You can customize the picture and sound by selecting the picture and sound modes or by adjusting its settings.

You can change the sound effect by selecting the surround mode.

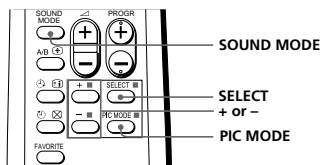

Selecting the picture and sound modes

To select the picture mode

Press PIC MODE repeatedly until you get the desired picture mode.

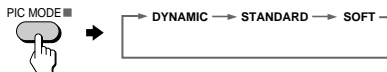

Select	To
DYNAMIC	receive high contrast pictures.
STANDARD	receive normal contrast pictures.
SOFT	receive mild pictures.

To select the sound mode

Press SOUND MODE repeatedly until you get the desired sound mode.

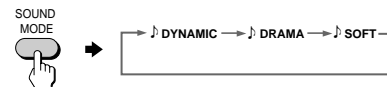

Select	To
DYNAMIC	listen to dynamic and clear sound that emphasizes the low and high sound.
DRAMA	listen to sound that emphasizes vocals and background music.
SOFT	receive soft sound.

Advanced Operations

continued

Customizing the picture and sound (continued)

Adjusting the picture and sound settings

- 1 Press SELECT until the desired setting appears.



Each time you press SELECT, the setting item will change as follows:



- 2 Press + or - to adjust the item.



- 3 To adjust other items, repeat steps 1 to 2.

* "HUE" can be adjusted for the NTSC system only.

Notes

- When you select a picture or sound mode, the adjusted settings will be reset according to the selected mode.
- You can also use SELECT and \triangle +/- on the TV to adjust the picture and sound settings.

Selecting the surround mode

- 1 Press SELECT repeatedly until "SURROUND" appears.



- 2 Press + or - to select the desired surround sound.



Select	To
MOVIE	listen to sound that spreads out over a large area, giving the feeling of being at a movie theatre.
MUSIC	listen to the sound that gives the feeling of being at a live concert.
OFF	turn off the surround sound.

Viewing your favorite channels

You can display six of your favorite channels for quick and easy selection. You can change the favorite channel setting as well.

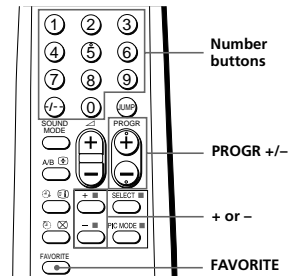

Selecting a favorite channel

- 1 Press FAVORITE.

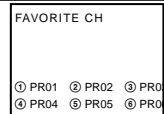

- 2 Press the number button from 1 to 6 to select the desired channel.

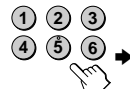

When you use the FAVORITE CH feature for the first time, six preset channels will appear.

Changing the favorite channel setting

- 1 Press SELECT until "FAVORITE CH SET UP" appears.



- 2 Press + or - to select the favorite channel you want to change (e.g. PR03).

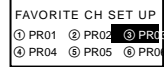

- 3 Press PROGR +/-, or number buttons to change the program number.

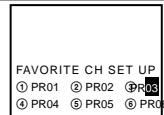
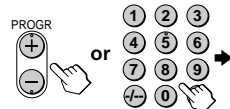

- 4 Repeat steps 2 and 3 to set other favorite channels.

- 5 Press SELECT.

Blocking the channels (CHILD LOCK)

You can prevent a child from watching certain channels by using the buttons on the remote control.

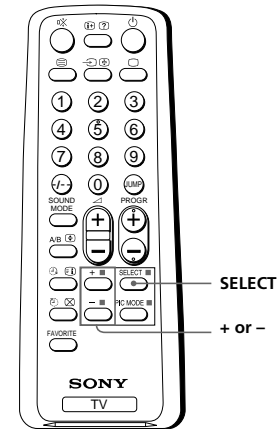

- 1 Select the channel you want to lock.

- 2 Press SELECT until "CHILD LOCK" appears on the screen.



CHILD LOCK: OFF

- 3 Press + or - to select "ON".

The  symbol appears on the screen.

To unlock the channel, press + or - to select "OFF". The  symbol disappears from the screen.

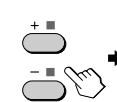



Note





- If you preset a locked channel, that particular channel will be unlocked automatically.

Additional Information

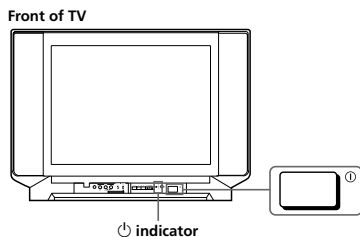
Self-diagnosis function

Your TV is equipped with a self-diagnosis function. If there is a problem with your TV, the  indicator flashes red. The number of times the  indicator flashes indicates the possible causes.



















- 1** Check that the  indicator flashes red a number of times between 3-second intervals.
- 2** Count the number of times the  indicator flashes.
- 3** Press  (main power) to turn off your TV.
- 4** Inform your nearest Sony service center about the number of times the  indicator flashes. Be sure to note the model name and serial number located on the rear of your TV.

Additional Information

Troubleshooting

If you find any problem while viewing your TV, please check the following guide. If any problem persists, contact your Sony dealer.

Symptom	Solutions	Possible cause
 Snowy picture	<ul style="list-style-type: none"> Check the antenna cable and connection on the TV, VCR and on the wall. (page 4) Press SELECT until "MANUAL PROGRAM" appears on the screen then preset the channel again. (page 10) 	<ul style="list-style-type: none"> Connection is loose or the cable is damaged. Channel presetting is inappropriate or incomplete.
 Noisy sound	<ul style="list-style-type: none"> Check the antenna type (VHF/UHF). Contact a Sony dealer for advice. Adjust the antenna direction. Contact a Sony dealer for advice. Try using a booster. 	<ul style="list-style-type: none"> The antenna type is inappropriate. The antenna direction is inappropriate. Signal transmission is low.
 Distorted picture	<ul style="list-style-type: none"> Turn off or disconnect the booster if it is in use. 	<ul style="list-style-type: none"> Broadcast signals are too strong.
 Noisy sound	 Good picture	<ul style="list-style-type: none"> If the sound of some channels are noisy, select the channel, then select the appropriate TV system ("TV SYS"). (page 10) The TV system setting is inappropriate.
 Noisy sound	 No picture	<ul style="list-style-type: none"> Check the power cord, antenna and the VCR connections. Press  (power). Press  (main power) on the TV to turn off the TV for about five seconds, then turn it on again.
 No sound		<ul style="list-style-type: none"> The power cord, antenna or VCR is not connected. The TV is not turned on.

Symptom	Solutions	Possible cause
Good picture 	<ul style="list-style-type: none"> Press \triangleleft + to increase the volume level. Press \times to cancel the muting. 	<ul style="list-style-type: none"> The volume level is too low. The sound is muted.
No sound 		
Dotted lines or stripes 	<ul style="list-style-type: none"> Do not use a hair dryer or other equipment near the TV. Adjust the antenna direction for minimum interference. Contact a Sony dealer for advice. 	<ul style="list-style-type: none"> There is local interference from cars, neon signs, hair dryers, power generators, etc.
Double images or "ghosts" 	<ul style="list-style-type: none"> Use a highly directional antenna. Use the fine tuning (FINE) function. (page 11) Adjust the antenna direction. Contact a Sony dealer for advice. Turn off or disconnect the booster if it is in use. 	<ul style="list-style-type: none"> Broadcast signals are reflected by nearby mountains or buildings. The antenna direction is inappropriate. Use of a booster is inappropriate.
No color 	<ul style="list-style-type: none"> Press SELECT until "COLOR" appears on the screen, then press + or - to adjust the color level. (page 16) Press SELECT until "COL SYS" appears on the screen, then check the color system setting (usually set this to "AUTO"). (page 11) Adjust the antenna direction. Contact a Sony dealer for advice. 	<ul style="list-style-type: none"> The color level setting is too low. The color system setting is inappropriate. The antenna direction is inappropriate.
Abnormal color patches 	<ul style="list-style-type: none"> Keep external speakers or other electrical equipment away from the TV. Do not move the TV while the TV is turned on. Press \odot (main power) on the TV to turn off the TV for about five minutes, then turn it on again. 	<ul style="list-style-type: none"> The magnetic disturbance from external speakers or other equipment, or the direction of the earth's magnetic field may affect the TV.

Troubleshooting (continued)

Symptom	Solutions	Possible cause
Picture slant (KV-XF21M83/ XF21M80 only) 	<ul style="list-style-type: none"> Press SELECT until "PIC ROTATION" appears on the screen, then press + or - to align the picture to the TV screen. (page 13) 	<ul style="list-style-type: none"> The terrestrial magnetism affects your TV set.
Lines moving across the TV screen.	<ul style="list-style-type: none"> Use the fine tuning (FINE) function. (page 11) 	<ul style="list-style-type: none"> There is interference from external sources, e.g., heavy machineries, nearby broadcast station.
The \odot indicator on your TV flashes red a number of times between 3-second intervals.	<ul style="list-style-type: none"> Contact your nearest Sony service center. (page 19) 	<ul style="list-style-type: none"> Your TV may need service.
TV cabinet creaks.	—	<ul style="list-style-type: none"> Changes in room temperature sometimes make the TV cabinet expand or contract, making a noise. This does not indicate a malfunction.
A "boom" sound is heard when the TV is turned on.	—	<ul style="list-style-type: none"> The TV's demagnetizing function is working. This does not indicate a malfunction.

continued

Additional Information | 21

22 | Additional Information

Identifying parts and controls

Refer to the pages indicated in parentheses () for details.

Front panel

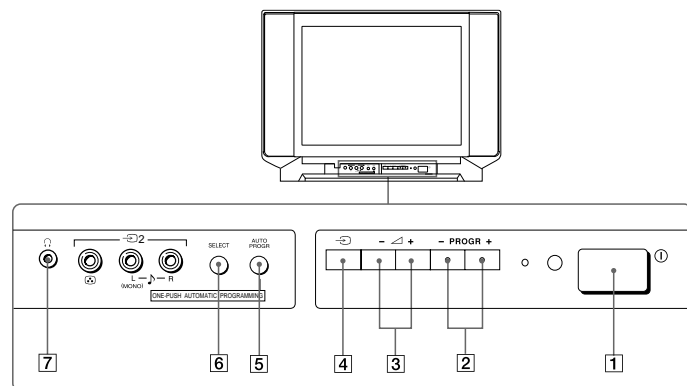

- 1 ① (main power) button (5)
- 2 PROGR +/- (program) buttons (10)
- 3 \triangleleft +/- (volume) buttons (12)
- 4 \rightarrow (TV/video) button (13)
- 5 AUTO PROGR (program) button (5)
- 6 SELECT button (10)
- 7 H (headphone) jack

Remote Control

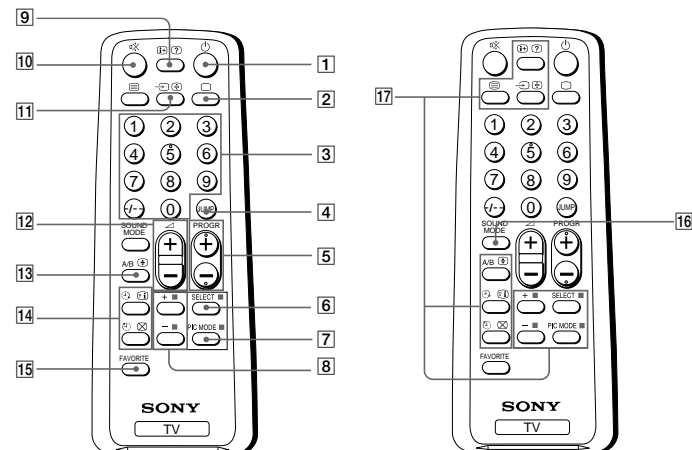

- 1 P (power) button (12)
- 2 TV button (13)
- 3 Number buttons (12)
- 4 JUMP button (13)
- 5 PROGR +/- buttons (10)
- 6 SELECT button (10)
- 7 PIC MODE button (15)
- 8 +/- buttons (10)
- 9 D (display) button (13)
- 10 M (muting) button (13)
- 11 V (video) button (13)
- 12 \triangleleft +/- (volume) buttons (12)
- 13 A/B button
(not used for this model)
- 14 Timer setting buttons (14)
 - W (wake up timer)
 - S (sleep timer)
- 15 FAVORITE button (17)

- 16 SOUND MODE button (15)
- 17 Teletext operation buttons
(not used for KV-HF21M80/
TF21M80/XF21M83/XF21M80)
 - T (text) E (enlarge)
 - R (reveal) H (hold)
 - I (index) X (text clear)
 - ■ (FASTEXT: red, green, yellow, blue)

Names/symbols of buttons on the remote are indicated in different colors to represent the available functions.

Label color	Button function
White	For general TV operations
Green	For Teletext operations

SECTION 2 DISASSEMBLY

2-1. REAR COVER REMOVAL

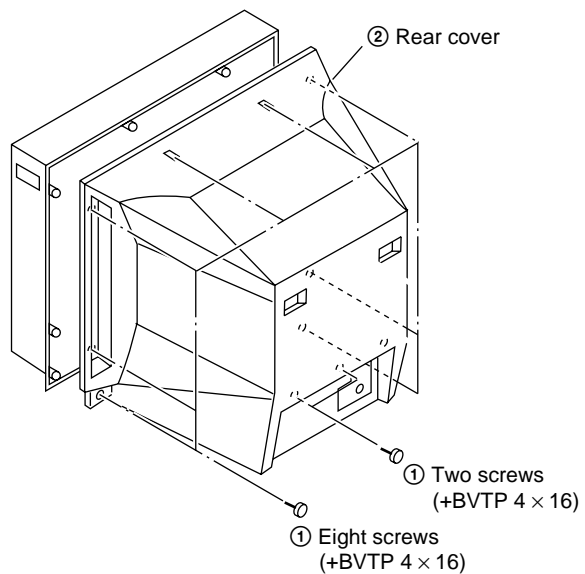

2-3. F BRACKET REMOVAL

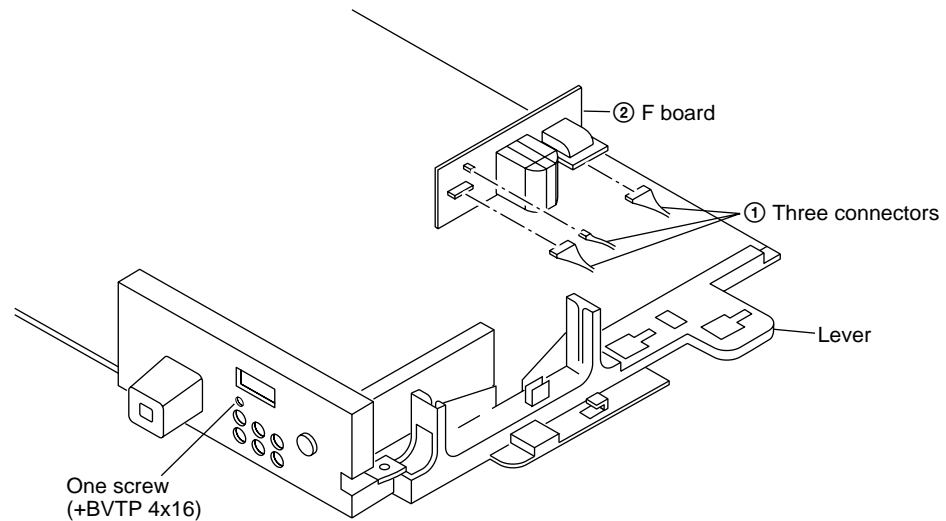

2-2. CHASSIS ASSY REMOVAL

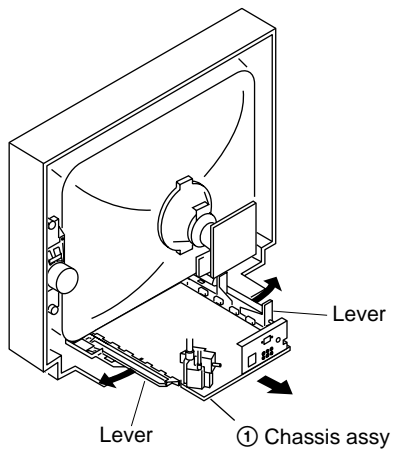

2-4. SERVICE POSITION

(Note: Remove F Bracket first.)

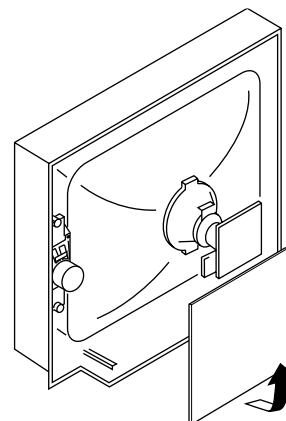

2-5. REPLACEMENT OF PARTS

For replacement of the Multi Button, unscrew it to exchange with new parts, and fix it with screws (+BVTP).

2-5-1. REPLACEMENT OF MULTI BUTTON

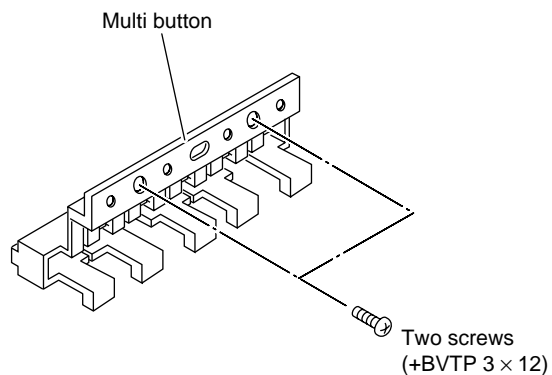

2-6. TERMINAL BRACKET REMOVAL

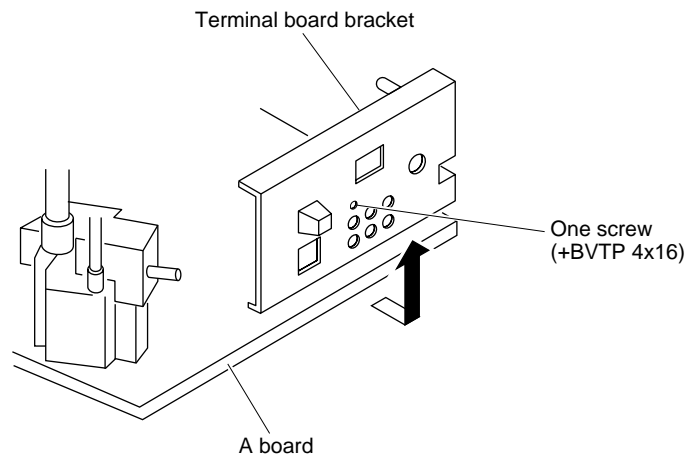

2-7. DEGAUSS COIL REMOVAL

2-5-2. REPLACEMENT OF LIGHT GUIDE

For replacement of Light Guide, pull it out to exchange with the new part.

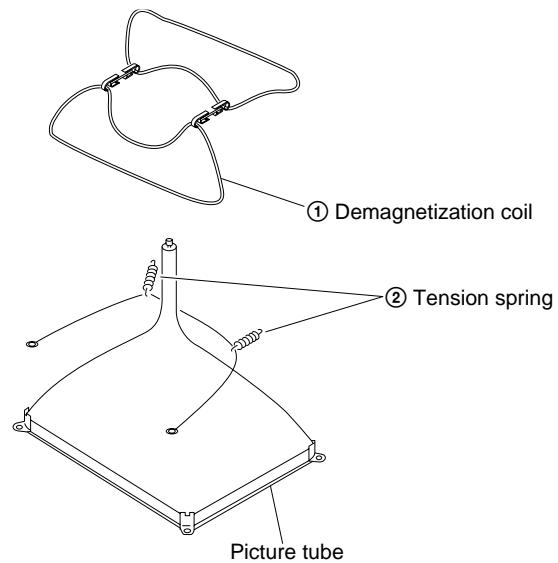
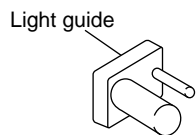

2-8. PICTURE TUBE REMOVAL

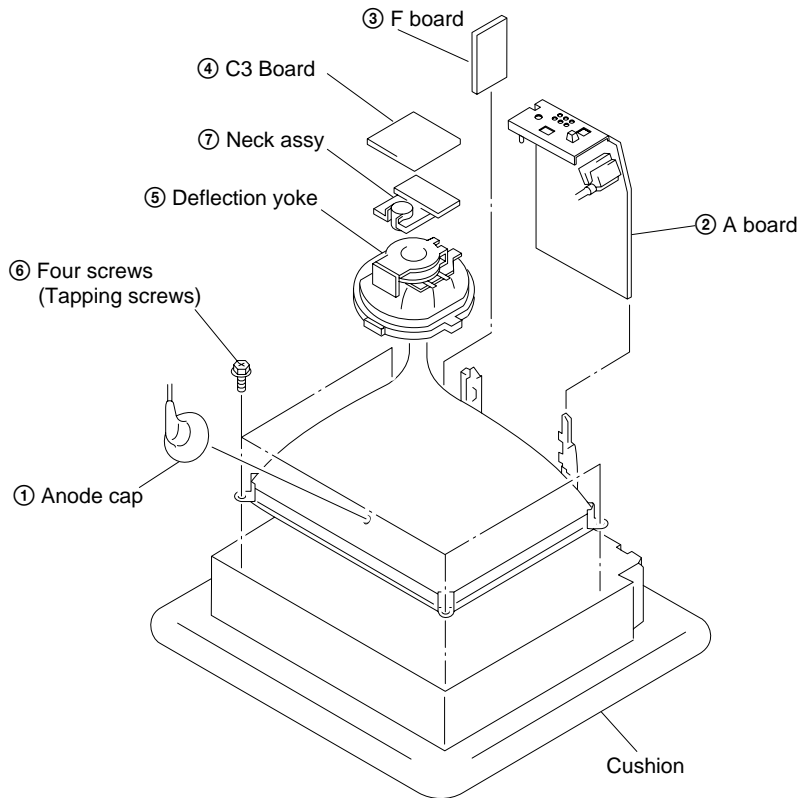

•REMOVAL OF ANODE-CAP

NOTE : After removing the anode, short circuit the anode of the picture tube and the anode cap to the metal chassis, CRT shield or carbon paint on the CRT.

•REMOVING PROCEDURES

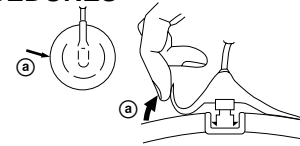

① Turn up one side of the rubber cap in the direction indicated by the arrow (a).

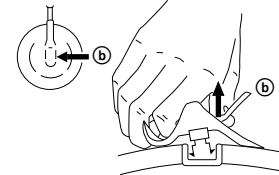

② Using a thumb pull up the rubber cap firmly in the direction indicated by the arrow (b).

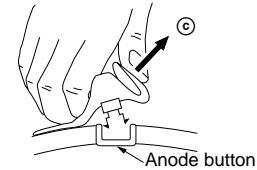

③ When one side of the rubber cap is separated from the anode button, the anode-cap can be removed by turning up the rubber cap and pulling it up in the direction of the arrow (c).

• HOW TO HANDLE AN ANODE-CAP

- ① Do not damage the surface of anode-caps with sharp shaped objects.
- ② Do not press the rubber too hard so as not to damage the inside of anode-cap. A metal fitting called the shatter-hook terminal is built into the rubber.
- ③ Do not turn the foot of rubber over too hard. The shatter-hook terminal will stick out or damage the rubber.

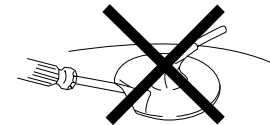
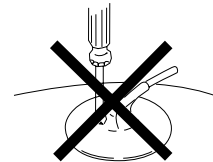

SECTION 3 SET-UP ADJUSTMENTS

- The following adjustments should be made when a complete realignment is required or a new picture tube is installed.
- These adjustments should be performed with rated power supply voltage unless otherwise noted.

Controls and switches should be set as follows unless otherwise noted:

PICTURE control normal
BRIGHTNESS control normal

Perform the adjustments in the following order :

1. Beam Landing
2. Convergence
3. Focus
4. White Balance

Note : Test Equipment Required.

1. Color-bar/Pattern Generator
2. Degausser
3. Oscilloscope

Preparation :

- In order to reduce the influence of geomagnetism on the set's picture tube, face it east or west.
- Switch on the set's power and degauss with the degausser.

3-1. BEAM LANDING

1. Input a white signal with the pattern generator.

Contrast	} normal
Brightness	
2. Position neck Assy as shown in Fig3-2.
3. Set the pattern generator raster signal to a green raster.
4. Move the deflection yoke to the rear and adjust with the purity control so that the green is at the center and the blue and the red take up equally sized areas on each side.
(See Figures 3-1 through 3-3.)
5. Move the deflection yoke forward and adjust so that the entire screen is green. (See Figure 3-1.)
6. Switch the raster signal to blue, then to red and verify the condition.
7. When the position of the deflection yoke has been decided, fasten the deflection yoke with the screws and DY spacers.
8. If the beam does not land correctly in all the corners, use a magnet to adjust it.
(See Figure 3-4.)

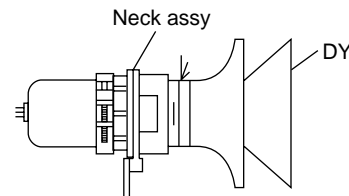

Note:
Neck Assy is exactly behind
DY (no gap between Neck
Assy and DY)

Fig. 3-2

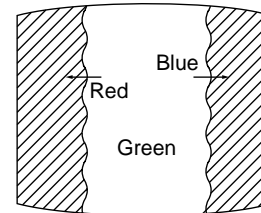

Fig. 3-3

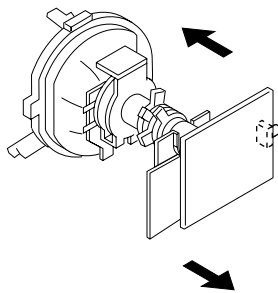

Fig. 3-1

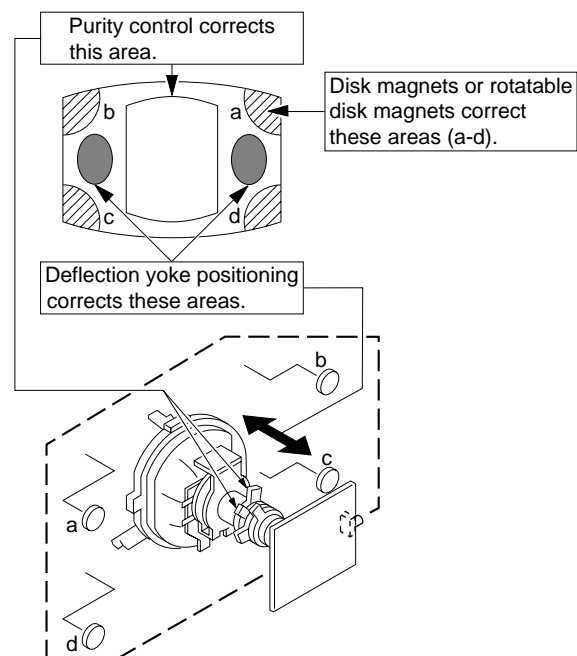

Fig. 3-4

3-2. CONVERGENCE

Preparation :

- Before starting this adjustment, adjust the focus, horizontal size and vertical size.
- Minimize the brightness setting.
- Provide dot pattern.

(1) Horizontal and Vertical Static Convergence

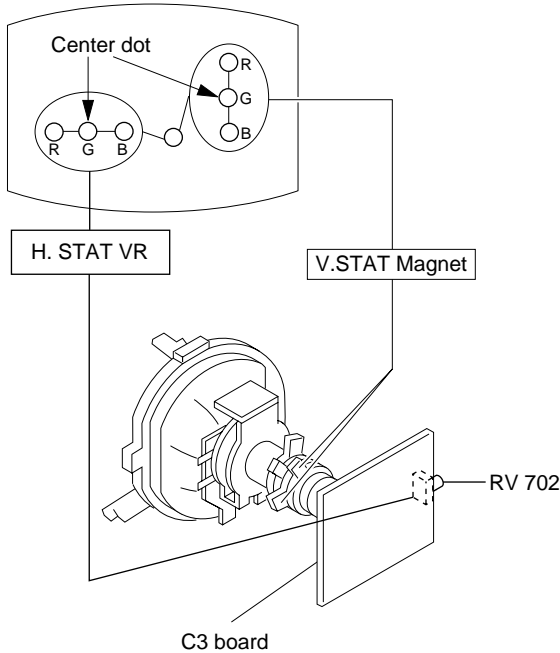

(Moving vertically), adjust the V. STAT magnet so that the red, green and blue dots are on top of each other at the center of the screen.

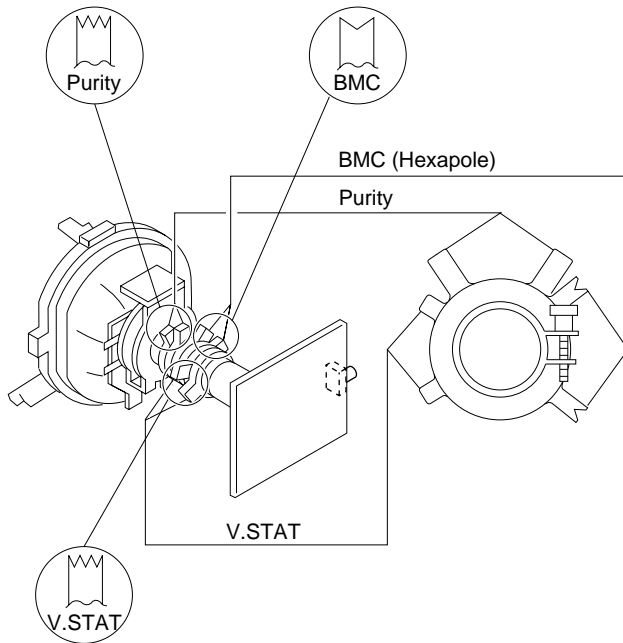

① V. STAT

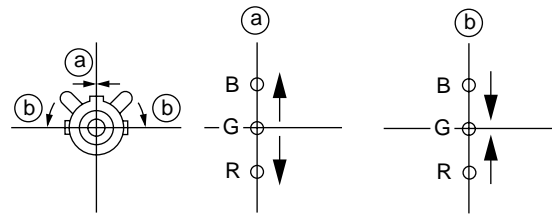

② H. STAT VR

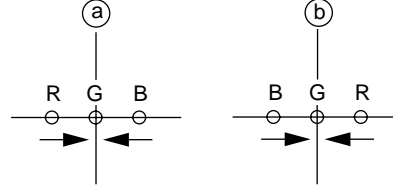

③

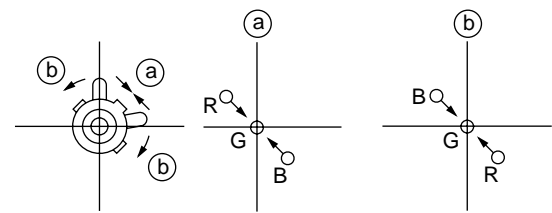

④ BMC (Hexapole) Magnet.

If the red, green and blue dots are not balanced or aligned, then use the BMC magnet to adjust in the manner described below.

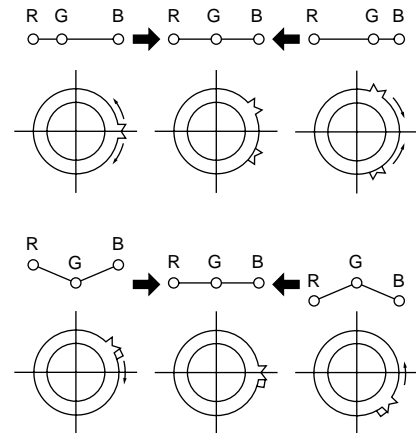

④ Y separation axis correction magnet adjustment.

1. Receive the cross-hatch signal and adjust [PICTURE] to [MIN] and [BRIGHTNESS] to [STANDARD] .
2. Adjust the Y separation axis correction magnet on the neck assembly so that the horizontal lines at the top and bottom of the screen are straight.

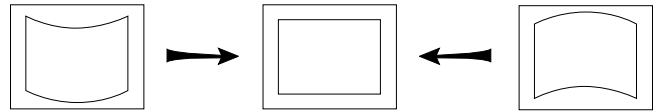
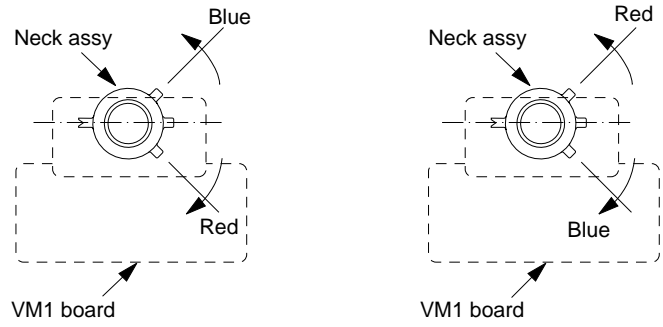

Note

1. The Red and Blue magnets should be equally far from the horizontal center line.
2. Do not separate the Red and Blue magnets too far. (Less than 8 mm)

(2) Dynamic Convergence Adjustment

Preparation:

- Before starting this adjustment, adjust the horizontal static convergence and the vertical static convergence

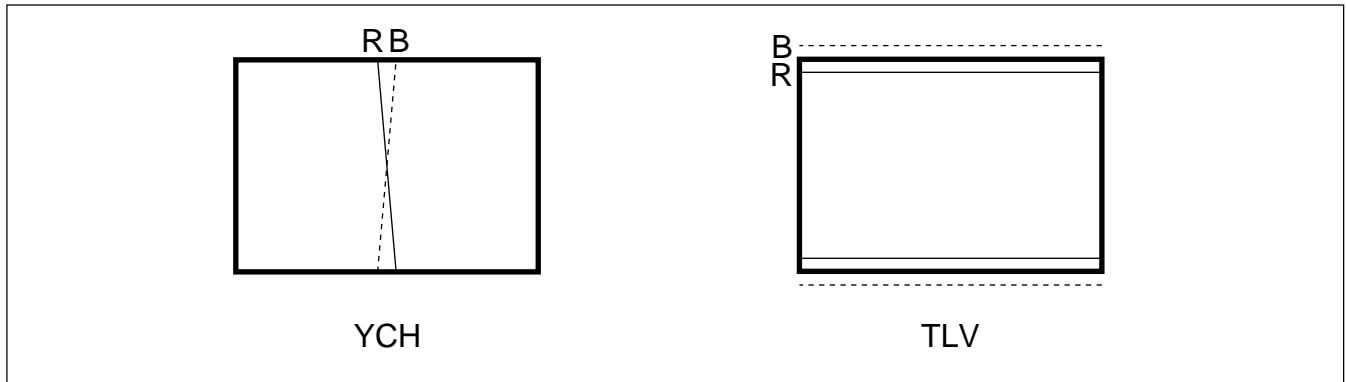

on DY

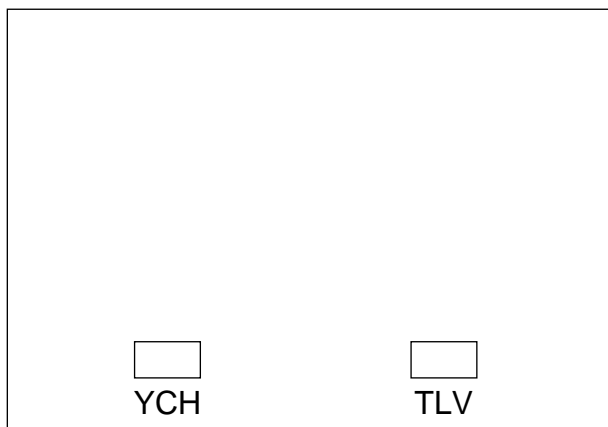

(3) Screen-corner Convergence

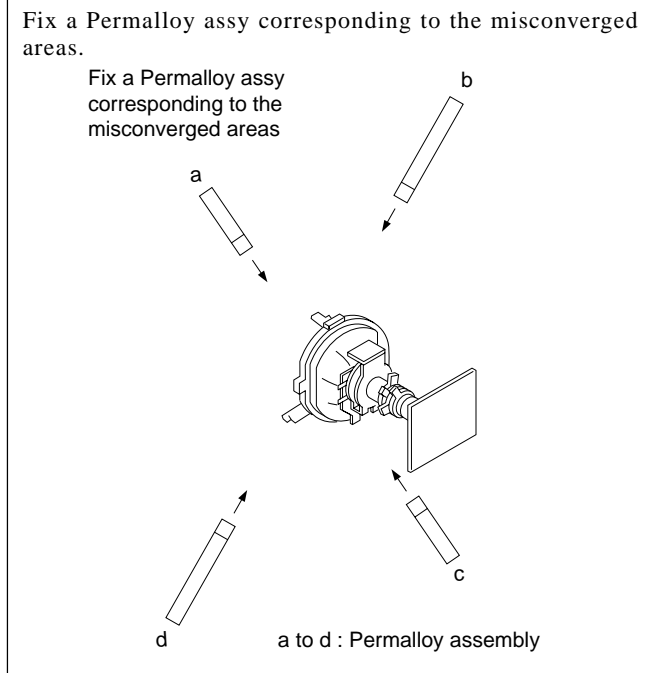
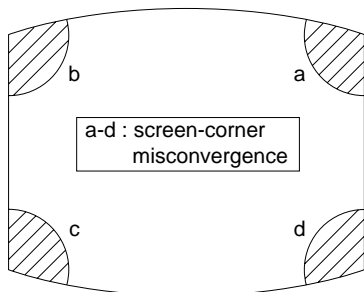

3-3. FOCUS ADJUSTMENT

Adjust FOCUS control on the flyback transformer for the best focus.

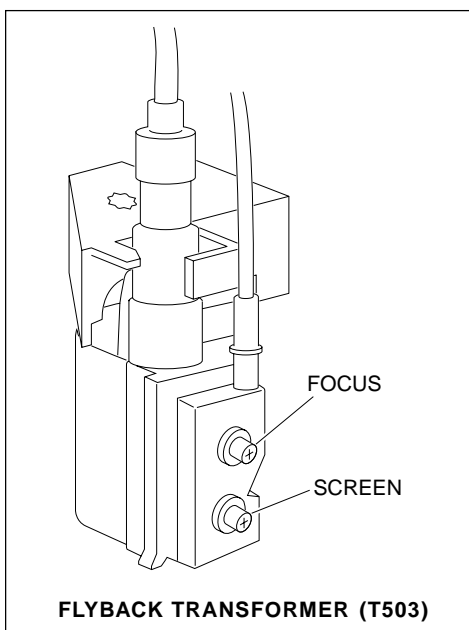

3-4. G2 (SCREEN) AND WHITE BALANCE ADJUSTMENTS

1. G2 (SCREEN) ADJUSTMENT

- 1) Set the PICTURE to normal.
- 2) Put to VIDEO input mode without signals.
- 3) Connect R, G and B of the C3 board cathode to the oscilloscope.
- 4) Adjust BRIGHTNESS to obtain the cathode voltage to the value below.
- 5) Adjust G2 (Screen) on FBT until picture shows the point before cut-off.

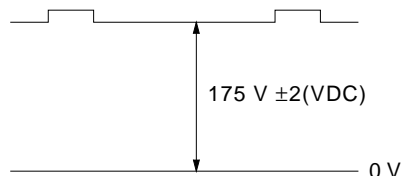

2. WHITE BALANCE ADJUSTMENT

- 1) Set to Service Mode (Refer Section 5-1: ADJUSTMENTS WITH COMMANDER).
- 2) Input white raster signal.
- 3) Set the PICTURE to minimum.
- 4) Select GCT (WHB 4) and BCT (WHB 5) with [1] and [4], and adjust the level with [3] and [6] for the best white balance.
- 5) Set the PICTURE to maximum.
- 6) Select GDR (WHB 1) and BDR (WHB 2) with [1] and [4], and adjust the level with [3] and [6] for the best white balance.
- 7) Write into the memory by pressing [MUTING] then [0].

3. SUB BRIGHT ADJUSTMENT

- 1) Set to service mode.
- 2) Input a staircase signal of black to white from the pattern generator.
- 3) BRIGHTNESS50%.
PICTURE MINIMUM
- 4) Select SBR (WHB7) with [1] and [4], and adjust SBR (WHB7) level with [3] and [6] so that the second stripe from the right is dimly lit.

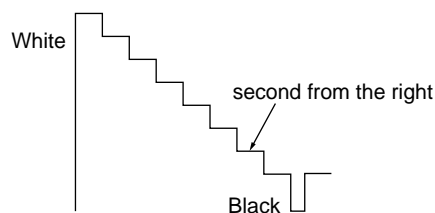

SECTION 4 CIRCUIT ADJUSTMENTS

4-1. ADJUSTMENTS WITH COMMANDER

Service adjustments are made with the RM-952 that comes with this unit.

a. ENTERING SERVICE MODE

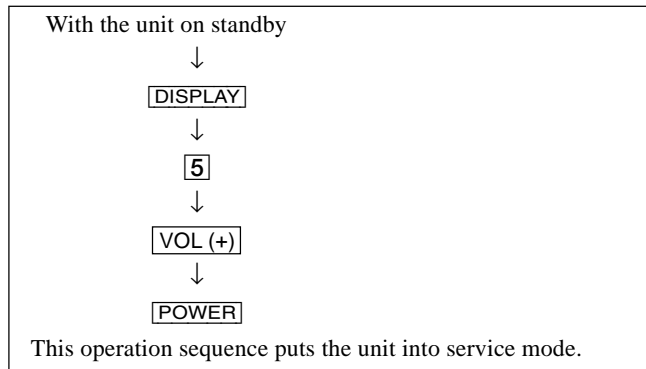

b. METHOD OF CANCELLATION FROM SERVICE MODE

Set the standby condition (Press [POWER] button on the commander), then press [POWER] button again, hereupon it becomes TV mode.

c. METHOD OF WRITE INTO MEMORY

- 1) Set to Service Mode.
- 2) Press [1] (UP) and [4] (DOWN), select an item of adjustment.
- 3) Press [MUTING] button and it will indicate WRITE on the screen.
- 4) Press [0] button to write into memory.

d. MEMORY WRITE CONFIRMATION METHOD

- 1) After adjustment, pull out the plug from AC outlet, and then plug into AC outlet again.
- 2) Turn the power switch ON and set to Service Mode.
- 3) Call the adjusted items again to confirm adjustments were made.

The screen display is :

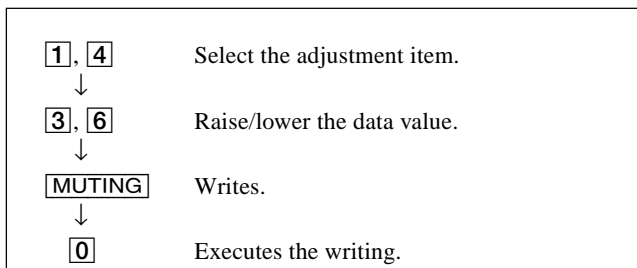
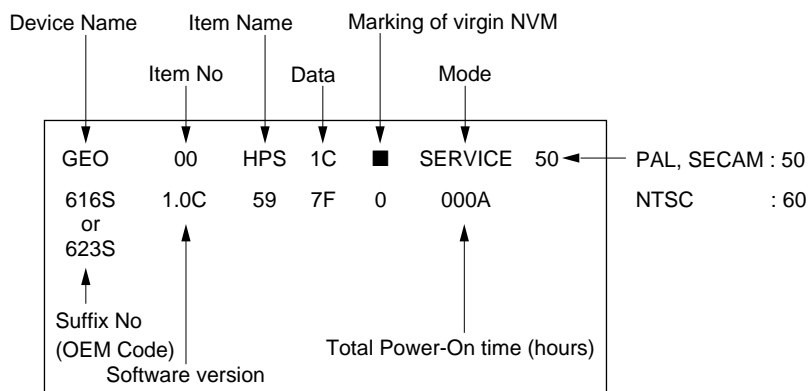

- [7], [0] All the data becomes the values in memory.
- [8], [0] All user control goes to the standard state.
- [5], [0] Service data initialization (Be sure not to use usually.)
- [2], [0] Write 50Hz adjustment data to 60Hz, or vice versa.

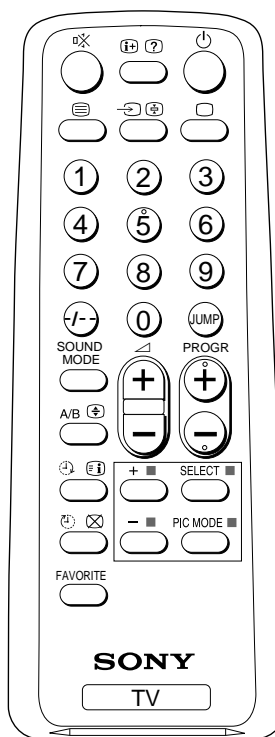

RM-952

4-2. ADJUSTMENT METHOD

Item Number 00 of device GEO

This explanation uses H-Position as an example.

1. Select "GEO 00 HPS" with the **[1]** and **[4]** buttons.
2. Raise/lower the data with the **[3]** and **[6]** buttons.
3. Select the optimum state. (The standard is 1F for PAL reception.)
4. Write with the **[MUTING]** button. (The display changes to WRITE.)
5. Execute the writing with the **[0]** button. (The WRITE display will be changed to red color while executing, and back to SERVICE.)

Use the same method for all Items. Use **[1]** and **[4]** to select the adjustment item, use **[3]** and **[6]** to adjust, write with **[MUTING]**, then execute the write with **[0]**.

- Note :**
1. In **[WRITE]**, the data for all items are written into memory together.
 2. For adjustment items that have different standard data between 50Hz or 60Hz, be sure to use the respective input signal after adjustment.

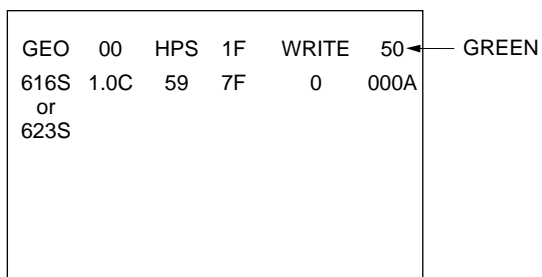
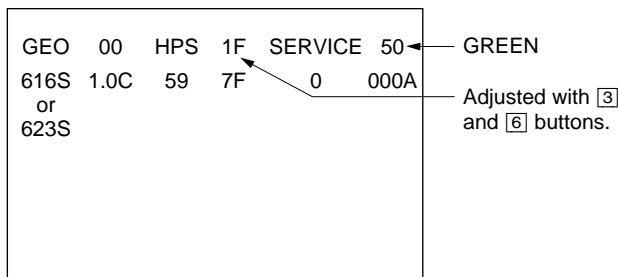

Written with **[MUTING]**

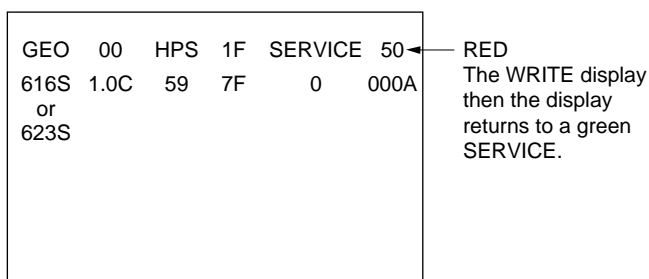

Write executed with **[0]**

Adjustment Item Table

Device Name	Functionality		Note	Data Range	Function	Note for Different Data	Register No. (bit)	Slava Address	RAM Address (bit)
	No	Name							
GEO	0	HPS	7	3F	H Position	50/60HZ	12 (7-2)	CXA2130S(88H)	82 (7-2)
	1	HSZ	1F	3F	H Size	50/60HZ	11 (7-2)		81 (7-2)
	2	PAP	1F	3F	Pin Amp	50/60HZ	13 (7-2)		83 (7-2)
	3	TLT	7	0F	Trapezium	50/60HZ	15 (7-4)		85 (7-4)
	4	VPS	1F	3F	V Position	50/60HZ	0F (7-2)		7F (7-2)
	5	VSZ	1F	3F	V Size	50/60HZ	0E (7-2)		7E (7-2)
	6	SCO	7	0F	S Correction	50/60HZ	10 (7-4)		80 (7-4)
	7	VLN	7	0F	V Linearity	50/60HZ	10 (3-0)		80 (3-0)
	8	BOW	7	0F	AFC Bow	50/60HZ	16 (7-4)		86 (7-4)
	9	AGL	7	0F	AFC-Angle	50/60HZ	16 (3-0)		86 (3-0)
	10	UPN	1F	3F	Upper Pin	50/60HZ	14 (7-2)		84 (7-2)
	11	LPN	1F	3F	Lower Pin	50/60HZ	18 (7-2)		88 (7-2)
	12	HBL	0	1	H Blanking on/off		18 (1)		67 (1)
	13	LBL	7	0F	Left H Blanking	50/60HZ	17 (7-4)		87 (7-4)
14	RBL	7	0F	Right H Blanking	50/60HZ	17 (3-0)	87 (3-0)		
WHB	0	RDR	2A	3F	R Drive	DYNAMIC/others	09 (7-2)	CXA2130S(88H)	8F (7-2)
	1	GDR	2A	3F	G Drive	DYNAMIC/others	0A (7-2)		90 (7-2)
	2	BDR	2A	3F	B Drive	DYNAMIC/others	0B (7-2)		91 (7-2)
	3	RCT	7	0F	R Cutoff	SECAM/others	07 (3-0)		93 (3-0)
	4	GCT	7	0F	G Cutoff	SECAM/others	08 (7-4)		94 (7-4)
	5	BCT	7	0F	B Cutoff	SECAM/others	08 (3-0)		94 (3-0)
	6	BMN	15	1F	Brightness Minimum Data				97
7	SBR	28	3F	Sub Brightness Control			98		
SAJ	0	PMX	33	3F	Picture Maximum Data			CXA2130S(88H)	96
	1	SHU	8	0F	Sub Hue Control	TV/Video			99
	2	SSH	3	0F	Sub Sharpness Control	TV/Video			9A
	3	SCL	1F	3F	Sub Color Control	NTSC/others			9B
VP	0	EHT	4	0F	EHT Comp	50/60HZ	15 (3-0)	CXA2130S(88H)	85 (3-0)
	1	GMA	2	03	Gamma Correction	Refer NVM Map A4	0B (1-0)		1A3 (1-0)
	2	YDL	6	0F	Y Delay	PAL/SECAM/NTSC	0C (3-0)		8C (3-0)
	3	SST	1	03	SECAM ID Start Position		1B (1-0)		6A (1-0)
	4	SSP	1	03	SECAM ID Stop Position		1B (3-2)		6A (3-2)
	5	SLV	2	03	SECAM ID Level		1C (1-0)		6B (1-0)
	6	SBF	22	3F	SECAM BELL fO		1C (7-2)		6B (7-2)
	7	DYC	0	1	Dynamic Color on/off		0A (1)		59 (1)
	8	ABL	1	1	ABL Mode Switching	Standard Always 0	09 (1)		58 (1)
	9	VTH	1	1	ABL Detection Vth Switching		09 (0)		58 (0)
	10	SF0	1	1	FO Switching for Sharpness	NTSC/others	05 (1)		198 (1)
	11	DCX	1	1	DC Trans. Ratio Switching		06 (1)		55 (1)
12	SHT	1	1	Pre-/Overshoot ratio Switch	NTSC/others	06 (0)	199 (0)		

Adjustment Item Table

Device Name	Functionality		Note	Data Range	Function	Note for Different Data	Register No. (bit)	Slava Address	RAM Address (bit)	
	No	Name								
VP	13	HDW	0	1	H Drive Pulse Width Switch	TV/Video/Text	00 (6)		4F (6)	
	14	AFC	1	03	AFC Gain Control		0F (1-0)		8D (1-0)	
	15	HOS	7	0F	H Oscillation		0C (7-4)		5B (7-4)	
	16	HSS	0	1	Slice Level of H Sync Sep.		0D (1)		5C (1)	
	17	VSS	0	1	Slice Level of V Sync Sep.	0D (0)	5C (0)			
	18	HMS	0	1	Macro Vision C/m off/on	50/60Hz	0E (0)		7E (0)	
	19	YUV	0	1	YUV Switch Control		01 (0)		50 (0)	
	20	CDV	1	3	CD mode for Video	Video only not memorized	0D (5-4)		1A1 (5-4)	
	21	RON	1	1	R ON		01 (3)		50 (3)	
	22	GON	1	1	G ON		01 (2)		50 (2)	
	23	BON	1	1	B ON		01 (1)		50 (1)	
	24	PON	1	1	P ON		00 (7)		4F (7)	
	25	BLK	0	1	BLK Off		12 (0)		61 (0)	
	26	VMC	0	1	VM Off	13 (0)	62 (0)			
AP	0	INF	0	3F	Input Attenuation When surround off		00 (5-0)	TDA7429	19F (5-0)	
	1	INS	0	3f	Input Attenuation When surround on		02		1A0 (5-0)	
	2	PH1	0	3	Phase 1 Register Selection				76 (1-0)	
	3	PH2	0	3	Phase 2 Register Selection				76 (3-2)	
	4	PH3	0	3	Phase 3 Register Selection				76 (5-4)	
	5	PH4	0	3	Phase 4 Register Selection		76 (7-6)			
	6	BCS	2	3	Bass Center Shift		#4 (3-0)		1A8 (1-0)	
	7	TCS	2	3	Treble Center Shift		#5 (3-0)		1A9 (1-0)	
8	TRF	2	3	RF Treble Offset	#5 (3-0)	1A9 (5-4)				
MSP	0	WST	15	FF	W/G Stereo Threshold			MSP3415D(84H) (844)	157 (7-0)	
	1	WBT	EA	FF	W/G Bilingual Threshold				158 (7-0)	
	2	WLL	5	FF	W/G Monaural Threshold				159 (7-0)	
	3	WAC	0	0F	W/G Agreement Count				15A (3-0)	
	4	WDL	30	FF	W/G Search Delay				15B (7-0)	
	5	NDL	20	FF	NICAM Search Delay				15C (7-0)	
	6	SDL	10	FF	Stereo status Read Delay				15D (7-0)	
	7	AGC	1	1	AGC Switch Auto/Constant				BB (7)	108 (7)
	8	REL	28	3F	AGC Gain at Constant Mode				BB (6-1)	108 (6-1)
	9	CRM	0	1	Carrier muting on/off				BB (9)	107 (9)
	10	ACO	1	1	Audio Clock out on/off				83 (5)	10C (5)
	11	FP	1B	7F	FM Prescale for non-M system				0E (7-0)	16C (6-0)
	12	FPM	32	7F	FM Prescale for M system				0E (7-0)	16D (6-0)
	13	FH	36	7F	FM Prescale for HDEV				0E (7-0)	16E (6-0)
	14	FHM	65	7F	FM Prescale for HDEV and M				0E (7-0)	16F (6-0)
	15	WGP	2A	7F	W/G Prescale				0E (7-0)	170 (6-0)
	16	NIP	6D	7F	NICAM Prescale				10 (7-0)	138 (6-0)
	17	ERR	50	FF	Auto FM switch Threshold				21 (10-3)	166 (7-0)
18	VOL	6D	FF	Loud Speaker gain 7000h to 7f0h	0000 (15-4)	1A7 (7-0)				

Adjustment Item Table

Device Name	Functionality		Note	Data Range	Function	Note for Different Data	Register No. (bit)	Slava Address	RAM Address (bit)
	No	Name							
TXT	0	TXH	1	3	Teletext Horizontal Position			(58H)	18D (1-0)
	1	TXV	0	3	Teletext Vertical Position				18D (6-4)
OPM	0	OSH	0A	3F	OSD H Position	Option-Misc			AC (7-2)
	1	COM	0	03	Comb Selection				A5 (7-6)
	2	APC	1	1	APC Switch				A4 (5)
	3	TSY	0	03	TV Sys at Auto TV Sys				A4 (4-3)
	4	MUT	0	1	No Signal Mute				A4 (0)
	5	AFM	0	1	Auto FM switch				A4 (1)
	6	RFB	0	3	C-BPF Control				A5 (5-4)
	7	TVO	0	7	Tilt to V-Angle offset				A5 (2-0)
	8	DBL	0	1	Disable Blueback Function				A4 (2)
OPB	0	OP1	FF	FF	Optional Bits 1 (see below)	Option-Bits			45
	1	OP2	1	FF	Optional Bits 2 (see below)				46
	2	OP3	0	FF	Optional Bits 3 (see below)				47

NOTE

- shaded items are fixed data.
- Standard data listed on the Adjustment Item Table are reference values, therefore it may be different for each model and for each mode.
- Note for Different Data Those are the standard data values written on the microprocessor. Therefore, the data values of the modes and stored respectively in the memory.
In case of a device replacement, adjustment by rewriting the data value is necessary for some items.

ITEM INFORMATION.

No. OPB0 OP1

Item	XTAL 4.43	XTAL 3.58	SECAM	2nd. Lang	B/G	I	D/K	M
KV-HF21M80	1	1	1	1	1	1	1	1

No. OPB1 OP2

Item	TOP	NICAM	HDEV	Thai Bil	Dis. Fav	DVD Input	AV Input	
KV-HF21M80	0	0	1	0	0	0	1	0

No. OPB2 OP3

Item	Pic Rot	2199	Auto PIC	Auto TV sys	US ST	AV Mono	11 KEY	Color SW
KV-HF21M80	0	0	1	1	0	0	0	0

4-3. PICTURE QUALITY ADJUSTMENTS

SUB COLOR ADJUSTMENT

1. Input a PAL color-bar.
2. Set to the following condition:
PICTURE 100%, BRIGHTNESS 50%, COLOR 50%
3. Connect an oscilloscope to pin ① (B OUT) of CN305, A board.
4. Set to Service Mode and select SAJ 3 'SCL' with **[1]** and **[4]** of the commander then adjust to VB2=VB3=VB4 with **[3]** and **[6]**.
5. Press **[MUTING]** → **[0]** of the commander to write the data.
6. Adjust SAJ 3 'SCL' as step 2 to 5 when receiving NTSC color-bar.

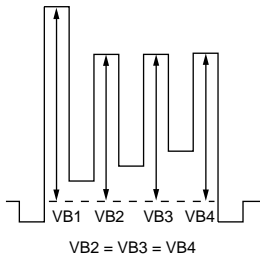

SUB HUE ADJUSTMENT

1. Select Video 1.
2. Input a NTSC color-bar, video into Video 1.
3. Set the following condition:
PICTURE 100%, BRIGHTNESS 50%, COLOR 50%
4. Connect an oscilloscope to pin ① (B OUT) of CN305, A board.
5. Select SAJ 1 'SHU' with **[1]** and **[4]** of the commander by setting to Service Mode and adjust to VB1=VB2=VB3=VB4 with **[3]** and **[6]**.

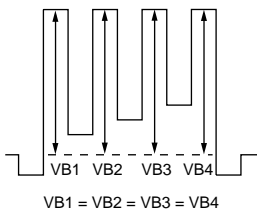

6. Press **[MUTING]** → **[0]** of the commander to write the data.

BELL FILTER ADJUSTMENT

1. Input SECAM color-bar signal.
2. Connect the dual-trace oscilloscope to the pin ⑨ (R-Y) of CN303 (not mounted).
3. Adjust SERVICE MODE, ITEMS 'SBF' as shown below.

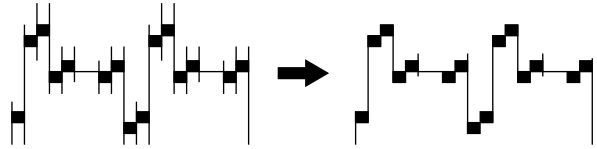

4-4. A BOARD ADJUSTMENT AFTER IC003 (MEMORY) REPLACEMENT

When replacing IC003 (MEMORY), be sure to change IC001 (μ -COM) to the following new IC at the same time.

IC001(μ -CON):CXP86449-616S (KV-HF21M60/HF21P50)
CXP86449-623S (KV-HF21M80)

1. Enter to Service Mode.
2. Press commander buttons **[5]** and **[0]** (Data Initialize), and **[2]** and **[0]** (Data Copy) to initialize the data.
3. Call each item number and check if the respective screen shows the normal picture.
In cases where items are not well adjusted, rectify the items with fine adjustment.
Write the data per each item number (**[MUTING]** + **[0]**).
4. Select item numbers "OPB0" (OP1), "OPB1" (OP2) and "OPB2" (OP3) and respectively set the bit per model with command buttons **[3]** and **[6]**.
5. Press commander buttons **[8]** and **[0]** (Test Normal) to return to the data that was set on the shipment from the factory.
(This will also cancel Service Mode.)

4-5. PICTURE DISTORTION ADJUSTMENT

Item Number 00 – 0B

GEO 0 HPS (H POSITION)

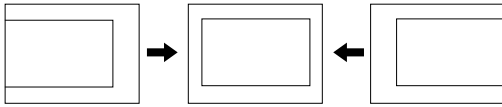

GEO 1 HSZ (H SIZE)

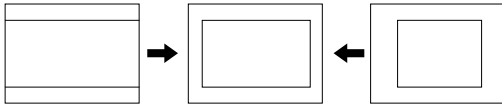

GEO 2 PAP (PIN AMP)

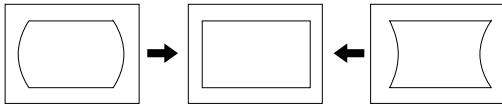

GEO 3 TLT (TRAPEZIUM)

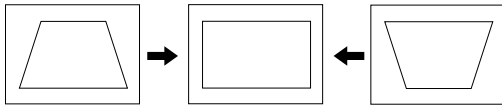

GEO 4 VPS (V POSITION)

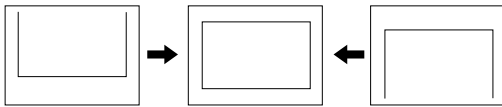

GEO 5 VSZ (V SIZE)



GEO 6 SCO (VERTICAL S-Correction)

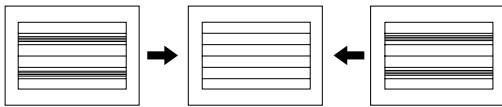

GEO 7 VLN (V LINEARITY)

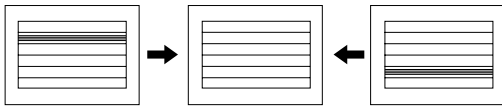

GEO 8 BOW (AFC.BOW)

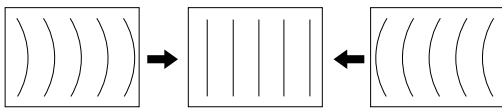

GEO 9 AGL (AFC.ANGLE)

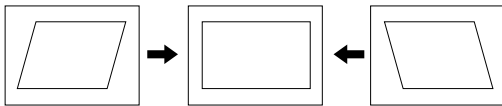

GEO 0A UPN (UPPER CORNER PIN)

GEO 0B LPN (LOWER CORNER PIN)

SECTION 5
DIAGRAM

KV-HF21M80
RM-952

KV-HF21M80
RM-952

KV-HF21M80
RM-952

5-1. BLOCK DIAGRAM

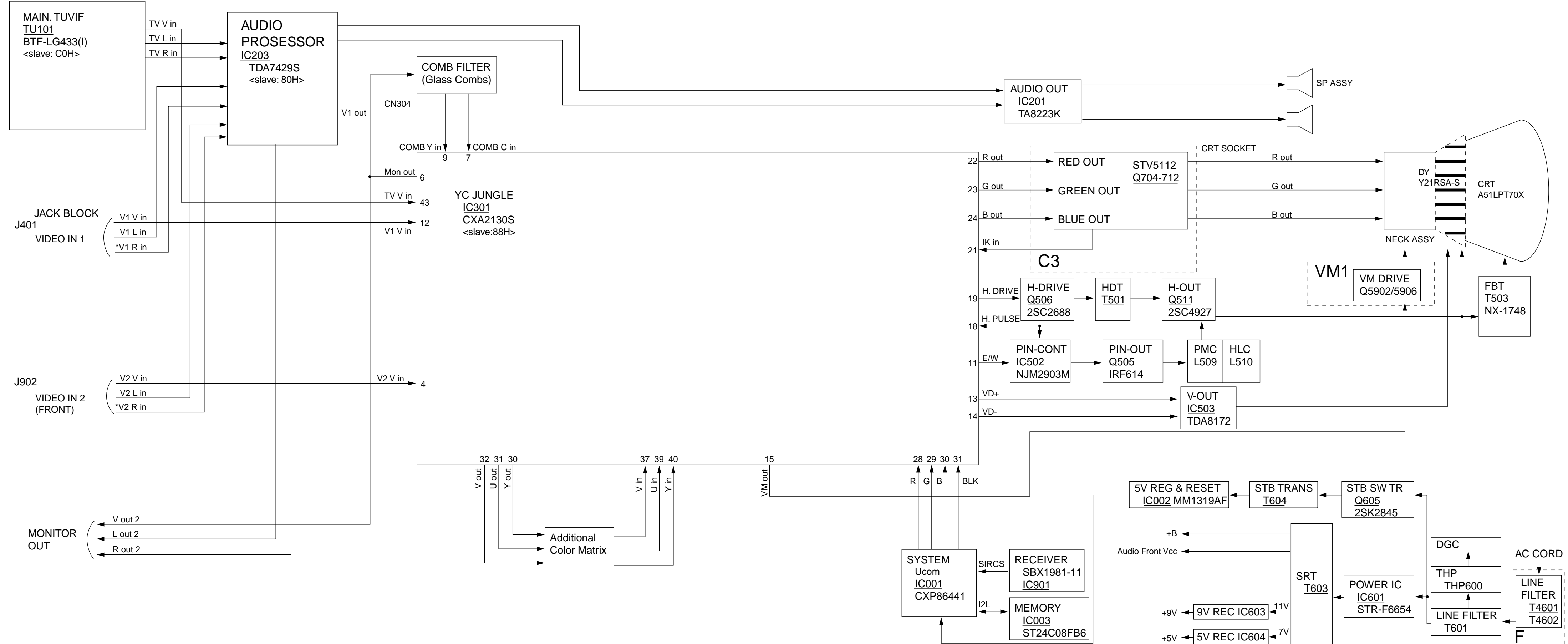





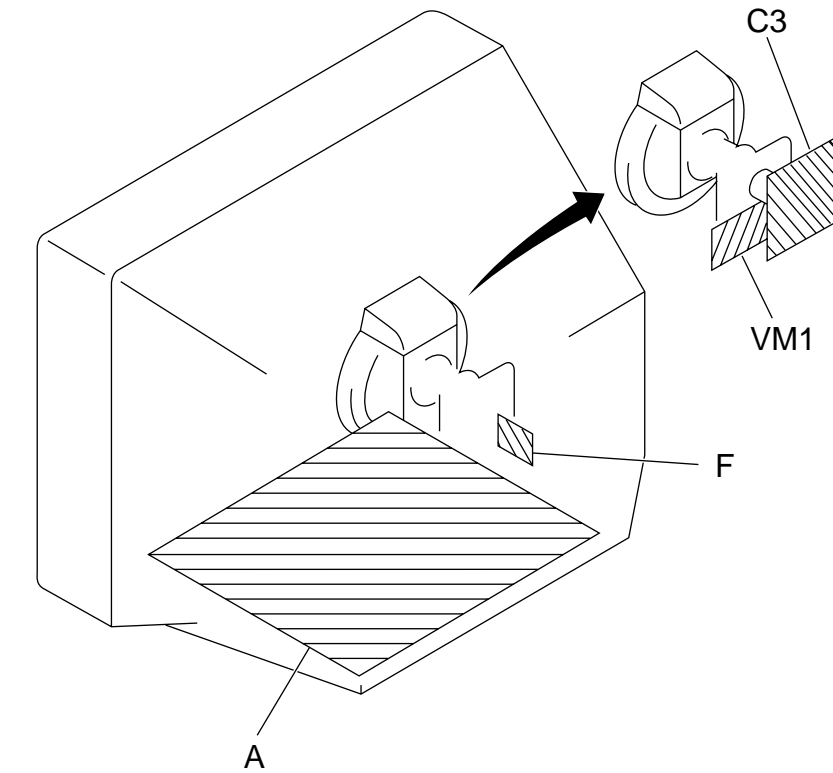
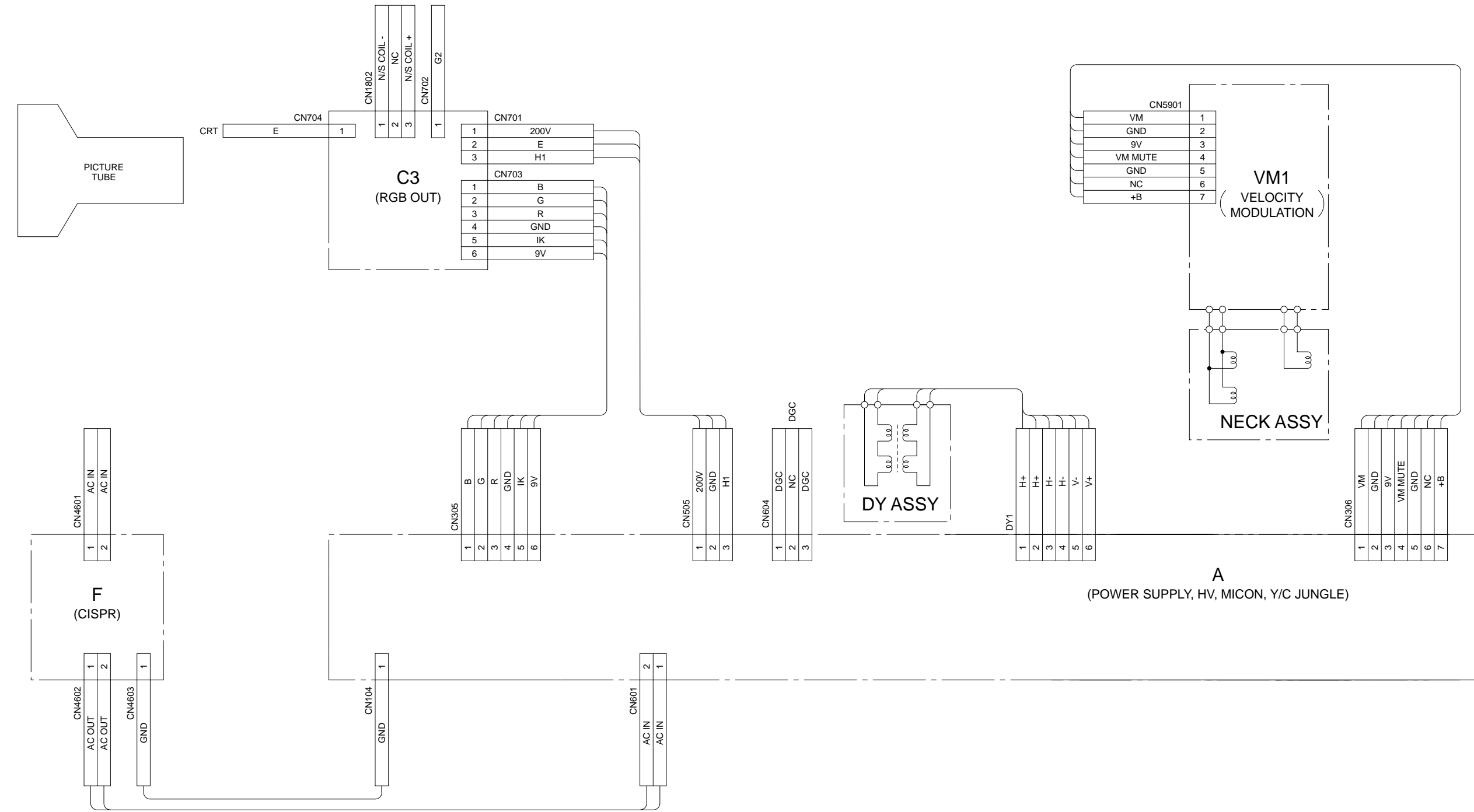

5-2. FRAME SCHEMATIC DIAGRAM

5-3. CIRCUIT BOARDS LOCATION



5-4. SCHEMATIC DIAGRAMS AND PRINTED WIRING BOARDS

Note:

- All capacitors are in μF unless otherwise noted.
 - All electrolytic capacitors are rated at 50V unless otherwise noted.
 - All resistors are in ohms.
 $\text{k}\Omega = 1000\Omega$, $\text{M}\Omega = 1000\text{k}\Omega$
 - Indication of resistance which does not have rating electrical power is as follows.
- Pitch: 5 mm
 Rating electrical power 1/4W (CHIP: 1/10W)
-  : nonflammable resistor.
 -  : internal component.
 -  : panel designation or adjustment for repair.
 - All variable and adjustable resistors have characteristic curve B unless otherwise noted.
 - **Readings are taken with a color-bar signal input.**
 no mark : PAL
 () : SECAM
 [] : NTSC 3.58
 « » : NTSC 4.43
 - **Readings are taken with a 10 M Ω digital multimeter.**
 - **Voltage are dc with respect to ground unless otherwise noted.**
 - **Voltage variations may be noted due to normal production tolerances.**
 - **All voltages are in V.**
 - * : Cannot be measured.
 - **Circled numbers are waveform references.**
 -  : B + bus.
 -  : B - bus.
 -  : signal path.

Reference information

RESISTOR	: RN	METAL FILM
	: RC	SOLID
	: FPRD	NONFLAMMABLE CARBON
	: FUSE	NONFLAMMABLE FUSIBLE
	: RS	NONFLAMMABLE METAL OXIDE
	: RB	NONFLAMMABLE CEMENT
	: RW	NONFLAMMABLE WIREWOUND
	: ✕	ADJUSTMENT RESISTOR
COIL	: LF-8L	MICRO INDUCTOR
CAPACITOR	: TA	TANTALUM
	: PS	STYROL
	: PP	POLYPROPYLENE
	: PT	MYLAR
	: MPS	METALIZED POLYESTER
	: MPP	METALIZED POLYPROPYLENE
	: ALB	BIPOLAR
	: ALT	HIGH TEMPERATURE
	: ALR	HIGH RIPPLE

Note: The component identified by shading and mark \triangle are critical for safety. Replace only with part number specified.

A BOARD WAVEFORMS

① 4.5Vp-p (V)	② 3.8Vp-p (V)	③ 3.7Vp-p (V)	④ PAL 1.1Vp-p (H)	④ SECAM 1.3Vp-p (H)
④ NTSC 3.58 1.2Vp-p (H)	④ NTSC 4.43 0.8Vp-p (H)	⑤ PAL/NTSC 3.58 PAL : 0.9Vp-p (V) NTSC 3.58 : 0.6Vp-p (V)	⑤ SECAM/NTSC 4.43 1.0Vp-p (V)	⑥ 0.8Vp-p (H)
⑦ PAL 1.1Vp-p (H)	⑦ SECAM 1.0Vp-p (H)	⑦ NTSC 3.58 0.7Vp-p (H)	⑦ NTSC 4.43 1.2Vp-p (H)	⑧ PAL 1.1Vp-p (H)
⑧ SECAM 1.1Vp-p (H)	⑧ NTSC 0.8Vp-p (H)	⑨ 0.8Vp-p (H)	⑩ PAL/NTSC PAL : 2.7Vp-p (H) NTSC : 2.8Vp-p (H)	⑩ SECAM 0.8Vp-p (H)
⑪ 3.1Vp-p (H)	⑫ PAL/NTSC 3.58 3.0Vp-p (H)	⑫ SECAM 3.0Vp-p (H)	⑫ NTSC 4.43 3.1Vp-p (H)	⑬ PAL/SECAM/NTSC 3.58 1.0Vp-p (H)
⑬ NTSC 4.43 0.9Vp-p (H)	⑭ 125Vp-p	⑮ 920Vp-p	⑯ 1.4Vp-p (V)	

(1) Schematic Diagram of A (1/2) Board

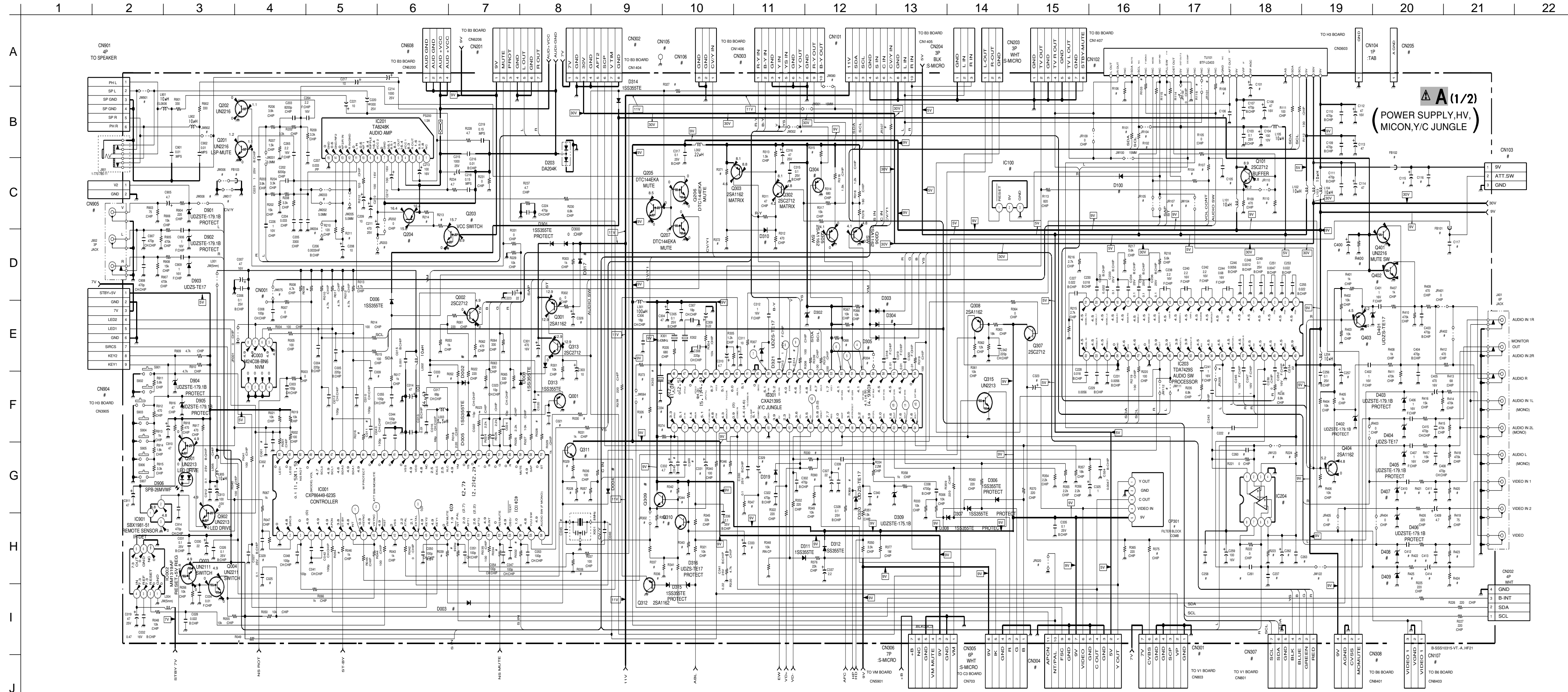

Schematic diagram
← A (1/2) board

Schematic diagram
A (2/2) board →

(2) Schematic Diagram of A (2/2) Board

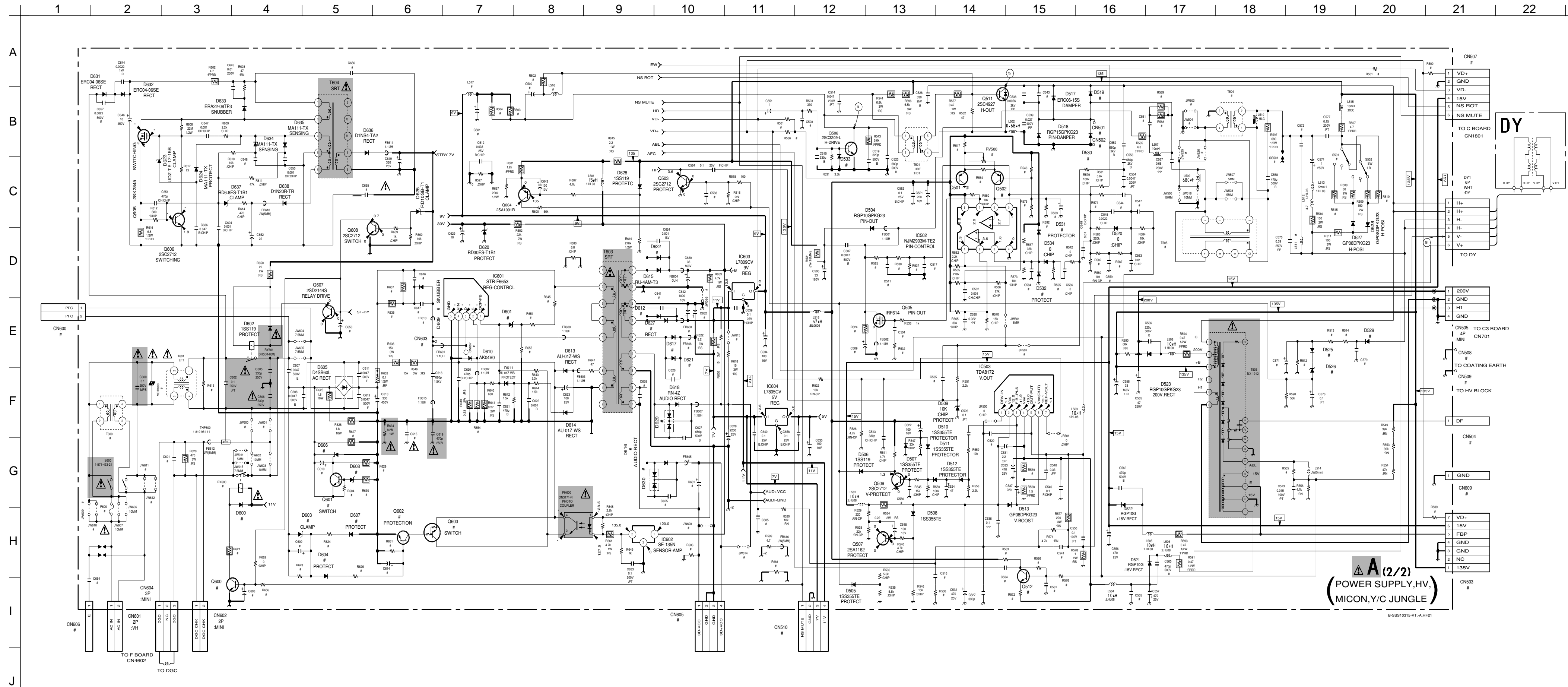

(3) Schematic Diagrams of C3 and F boards

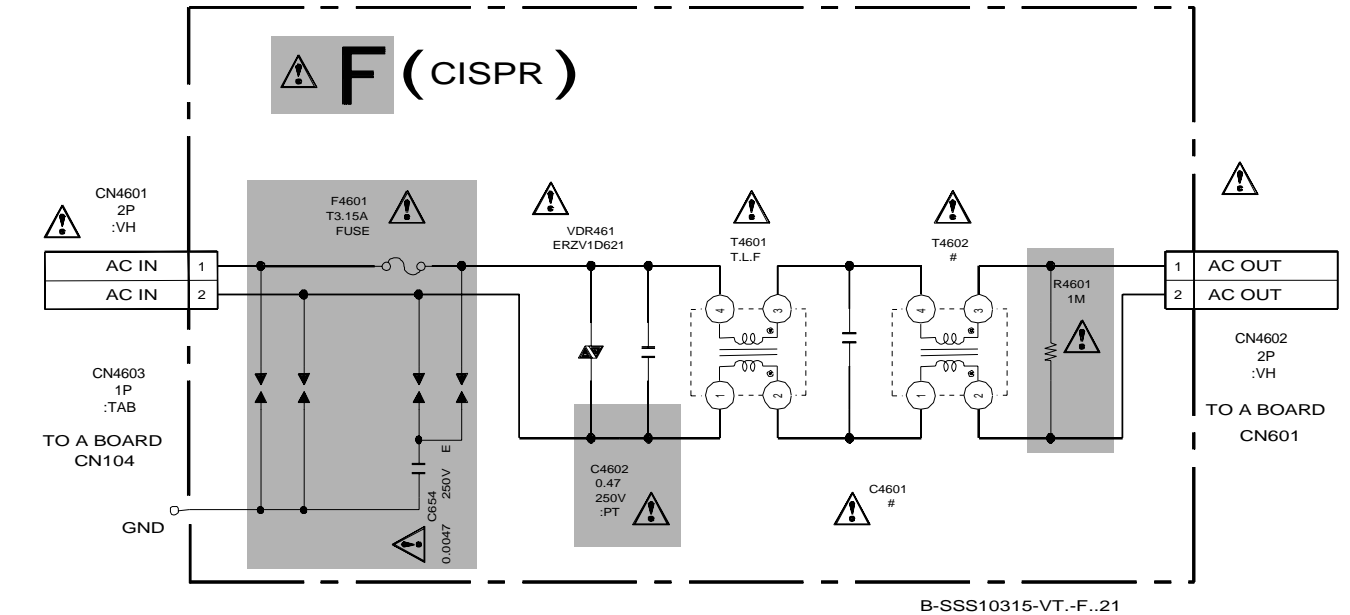
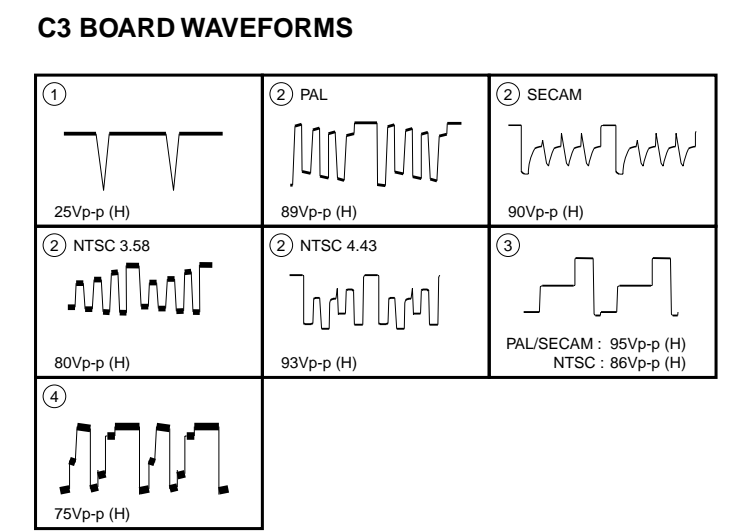
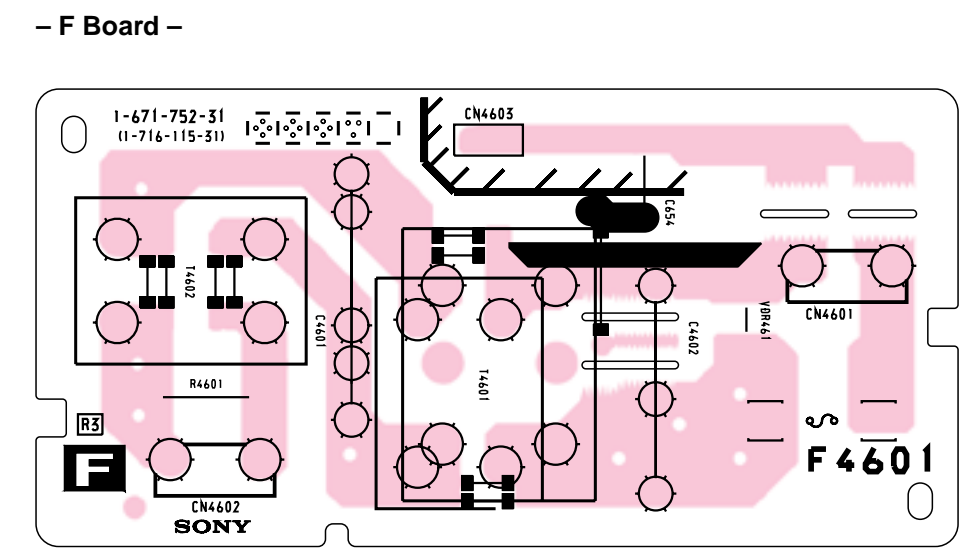
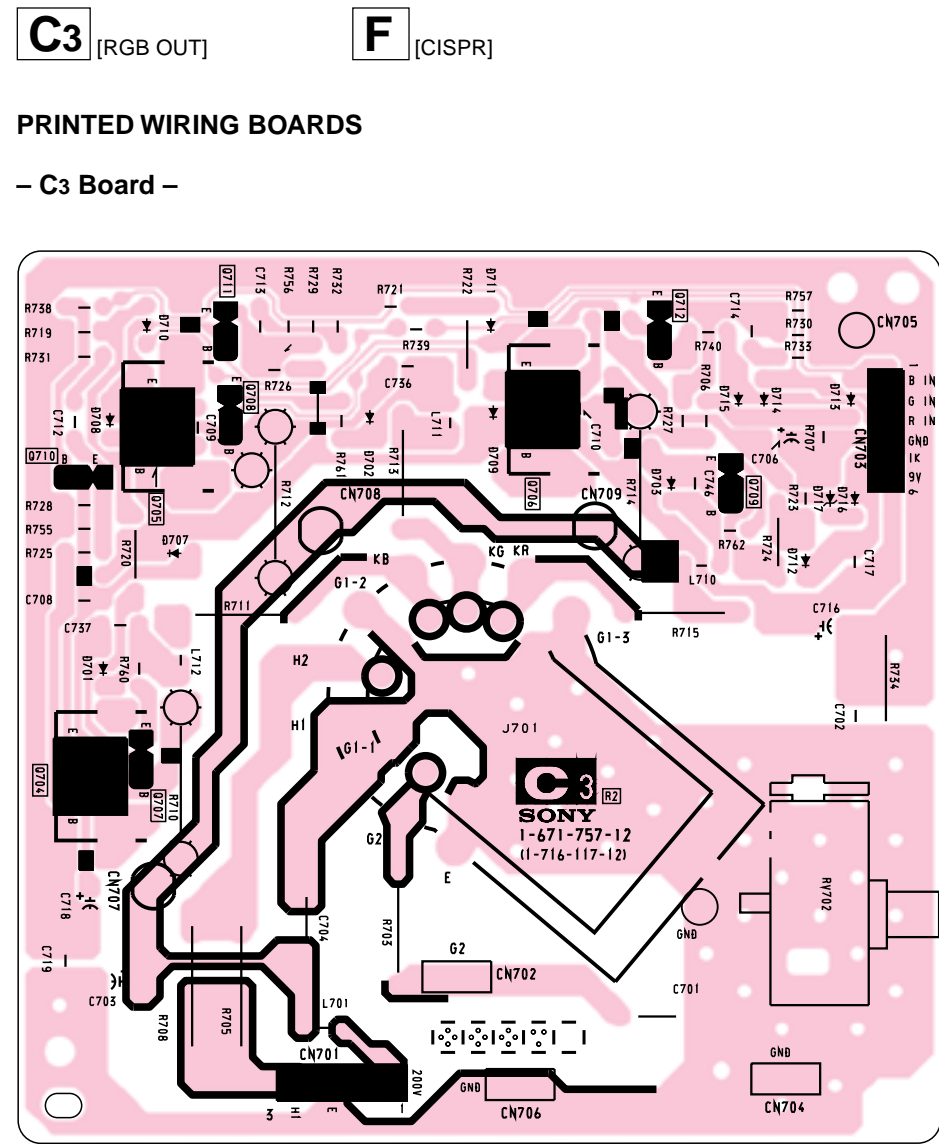
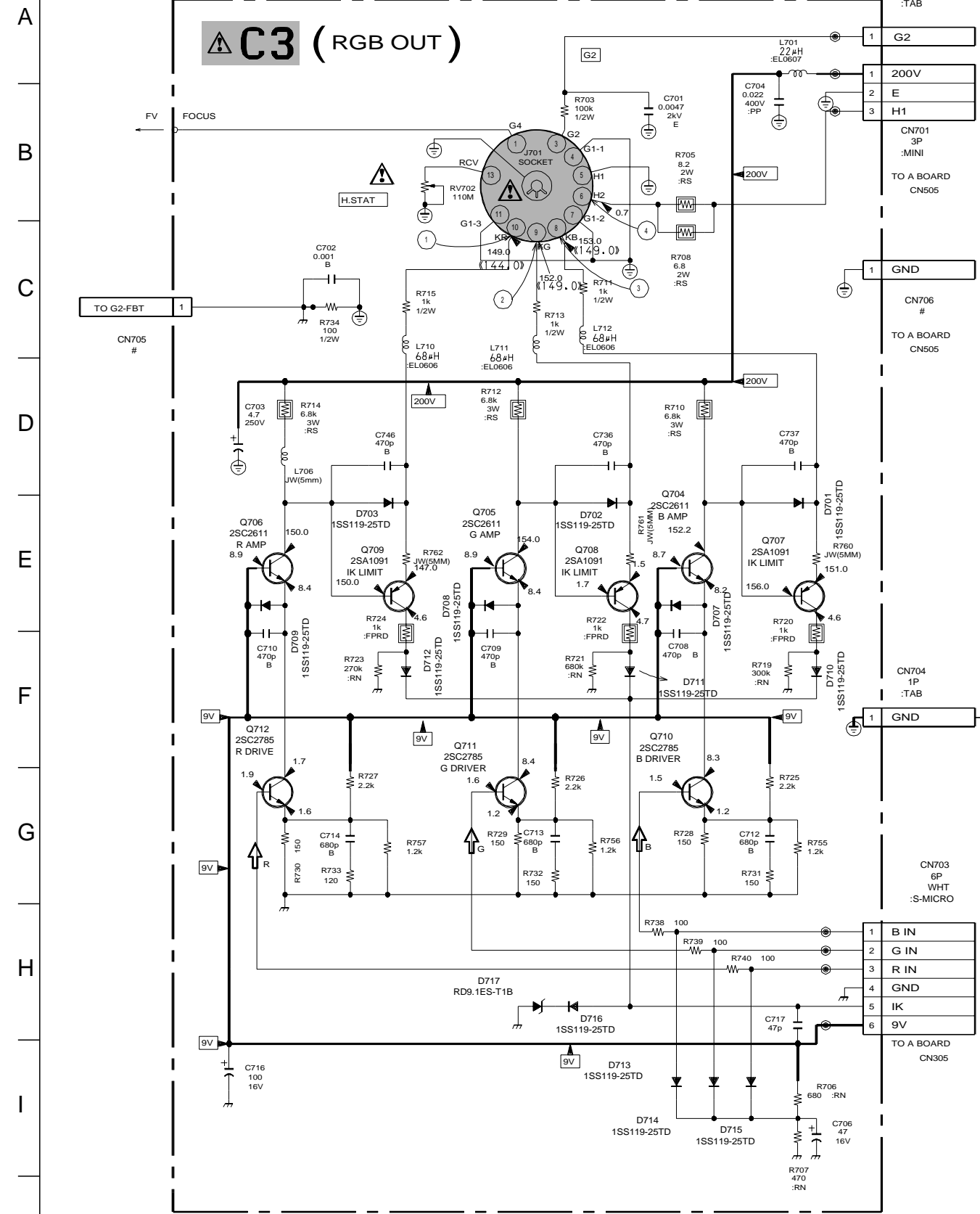
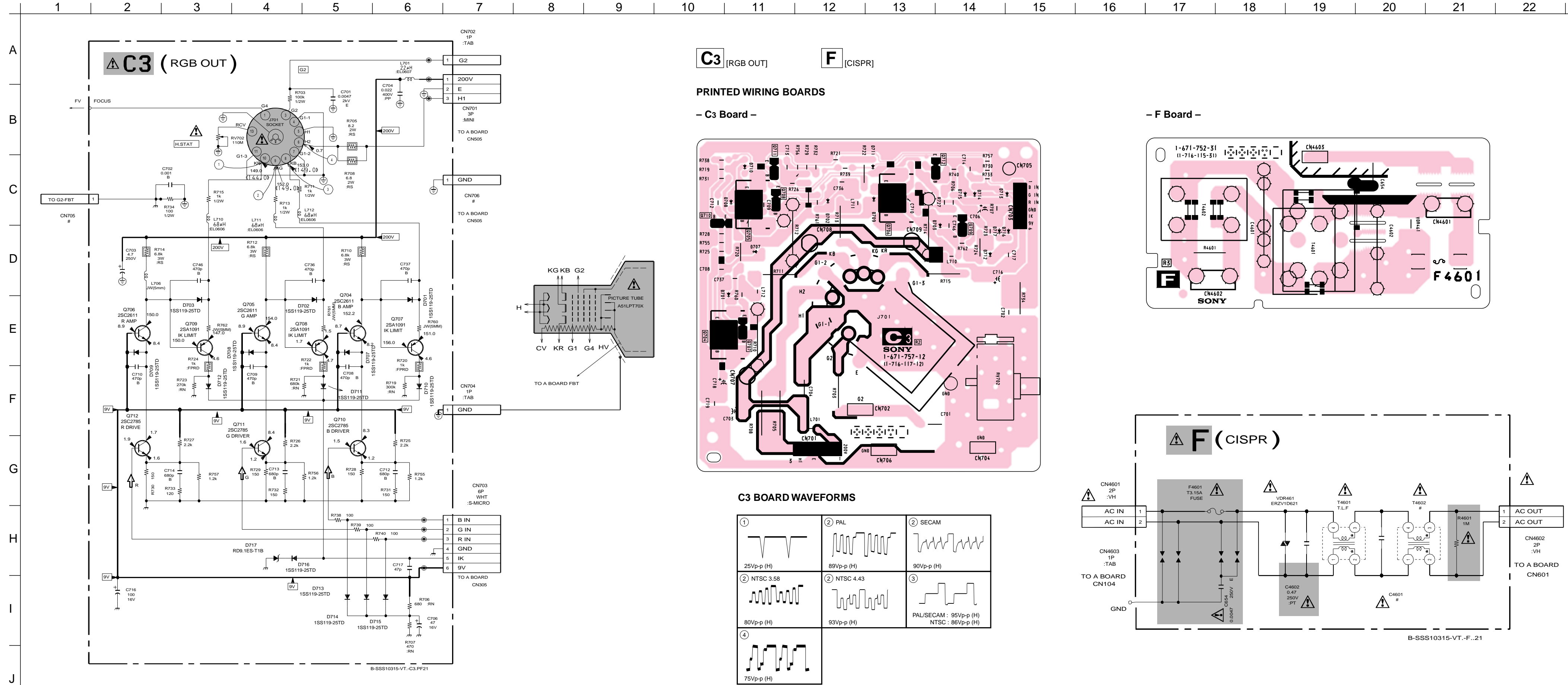

(4) Schematic Diagram of VM1 board

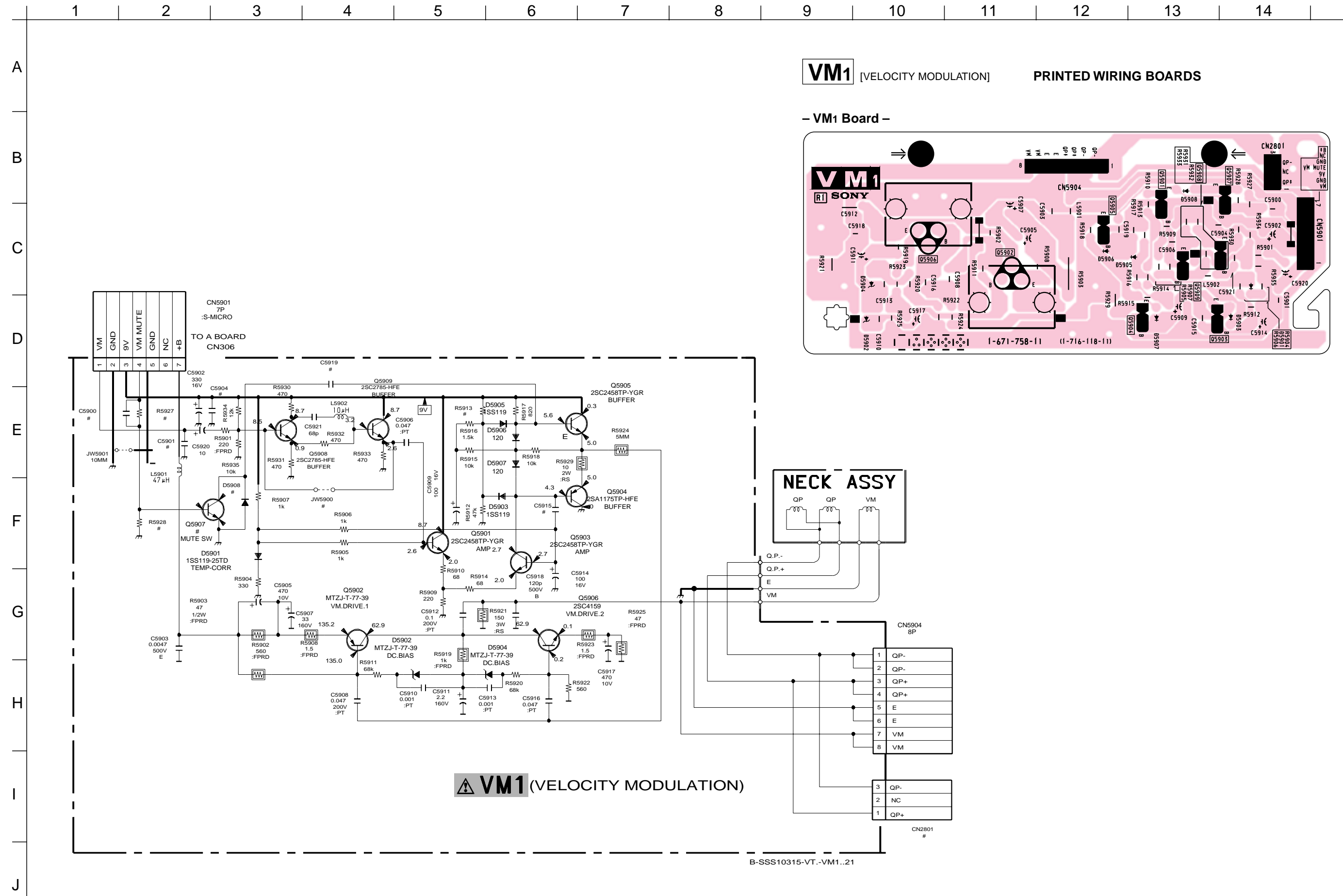

5-5. SEMICONDUCTORS

DIODE

- AU-01Z-V1
- EL1Z
- ERA22-08
- GP08D
- RD33EB3T
- RGP02-17EL-6433

ON3171-R

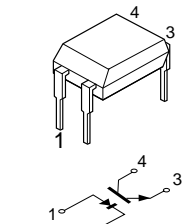

FMU-G26S

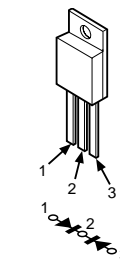

TRANSISTOR

- DTA114EKA-T146
- DTC114EK
- UN2111
- UN2213
- UN2216
- 2SA1162-G
- 2SC2712-YG
- 2SC1623-L5L6
- 2SD2114K

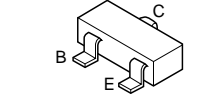

LED

- L204
- *****
- SPB-26MVWF

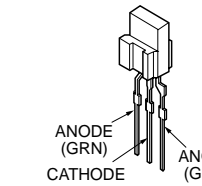

TR DTC144EKA
2SA1175-HFE
2SC2785-HFE

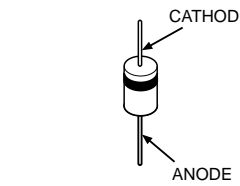
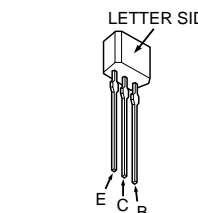

D4SB60L

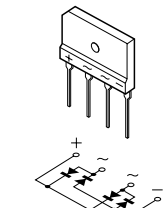

ERC04-06SE
RS3FS
RU-1P
RU4Z
31DQ06-FC5

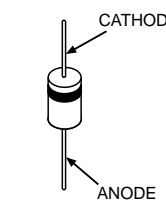

DTZ-TT11-15B
RD10S-B
RD5.1SB-T2
RD9.1S-B
UDZS-TE17-5.1B
UDZS-TE17-6.8B
UDZS-TE17-9.1B

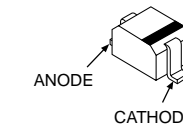

ERD29-08J

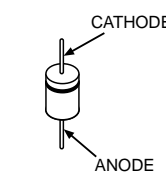

DA204K

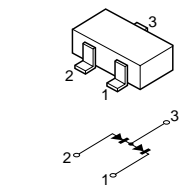

DTZ10B
MA111-(K8).S0
RD5.1SB-T2
1SS355TE-17

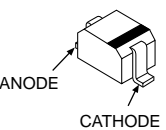

5P-6M

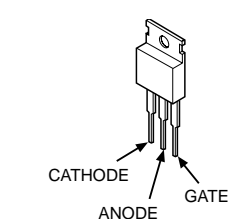

2SA1091-0
2SA933AS-QT

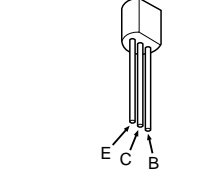

2SA1606-E
2SA1837
2SC4793

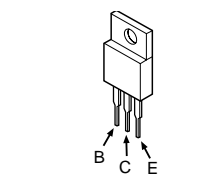

2SC2458-YGR
2SD2144S-UVW

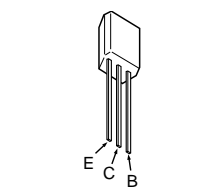

2SC2611

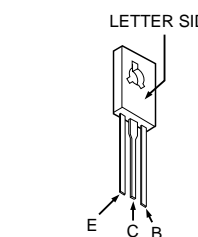

SECTION 6 EXPLODED VIEWS

NOTE:

- Items with no part number and no description are not stocked because they are seldom required for routine service.
- The construction parts of an assembled part are indicated with a collation number in the remark column.
- Items marked "*" are not stocked since they are seldom required for routine service. Some delay should be anticipated when ordering these items.

The components identified by shading and mark Δ are critical for safety. Replace only with part number specified.

6-1. CHASSIS

- ▲ : BVTP3 × 12 7-685-648-79
- : BVTP4 × 16 7-685-663-71

2SC4927-01

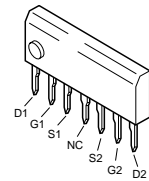

2SA1037AK-T146-R
2SD774-34

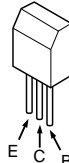

IRF614

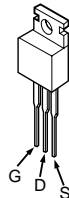

2SK2845-LB102

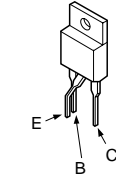

2SC4159-E

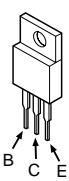

IC

CXA2139S (48PIN)
CXP86449-616S (64PIN)
CXP86449-623S (64PIN)
ST24C08FB6 (8PIN)
TDA7429S (42 PIN)

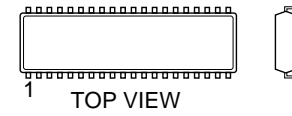

Dual In-line Package
Pin 6~98

MM1319AFBE (7PIN)
NJM2903M (8PIN)

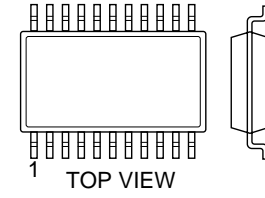

Single In-line Package
Pin 6~98

NJM78M09FA
TA7805S

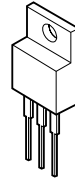

SBX1981-51P

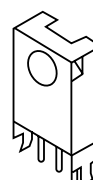

SE-135N



TDA8172

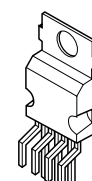

STR-F6654

MARKING SIDE VIEW

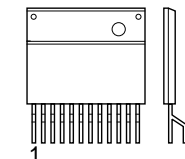

Zig-zag In-line Package
Pin 6~99

TA8223K

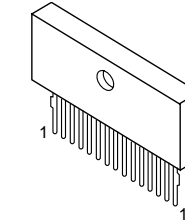

S-80743AL-A7-S

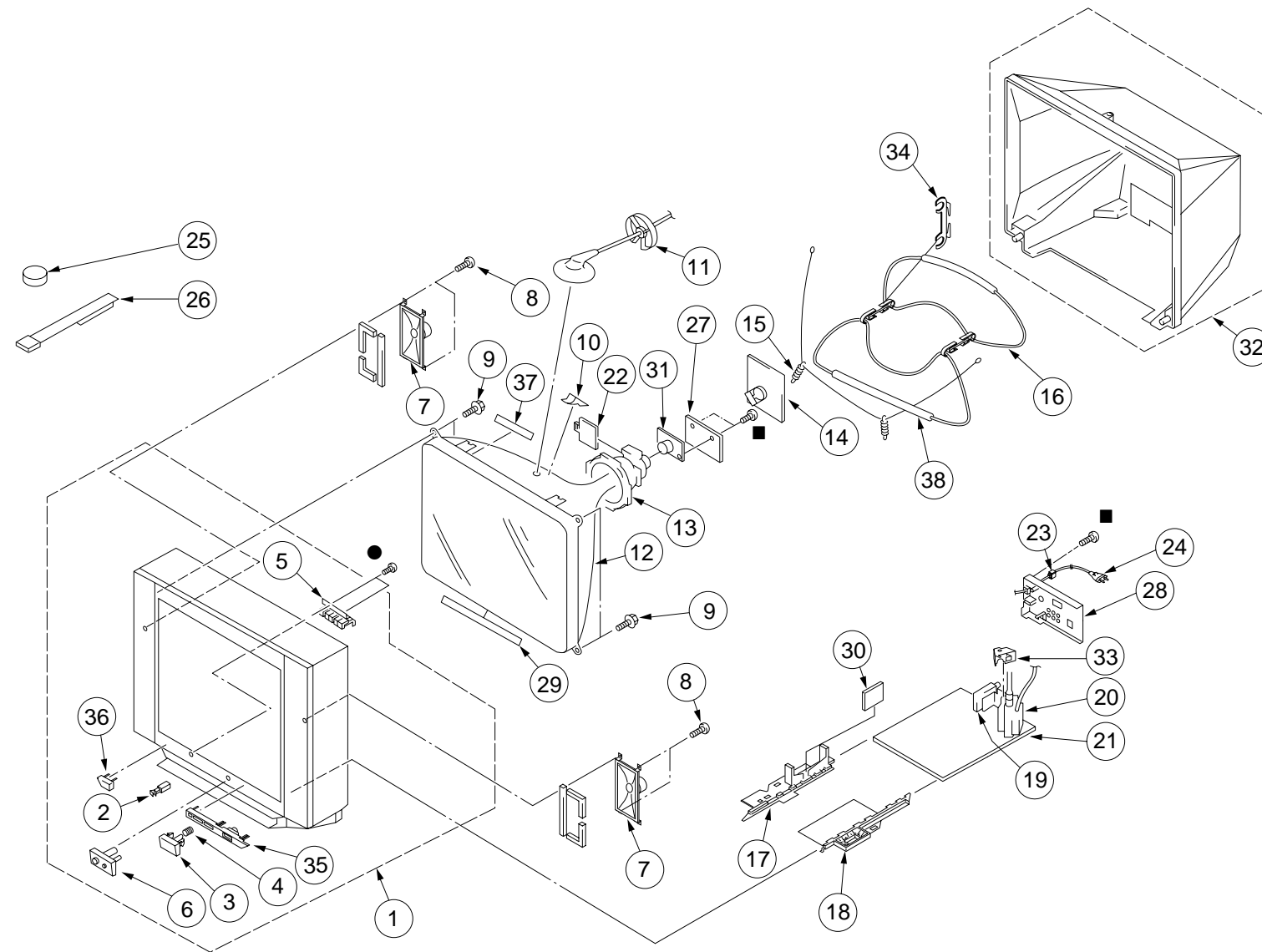
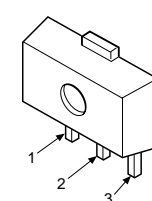

REF. NO.	PART NO.	DESCRIPTION	REMARK
1	X-4037-395-1	BEZNET ASSY	2,6,34
2	4-047-464-01	CATCHER, PUSH	
3	4-067-190-01	BUTTON, POWER	
4	4-036-405-21	SPRING, COMPRESSION	
5	4-067-196-01	BUTTON, MULTI	
6	4-067-197-01	GUIDE, LIGHT	
7	1-503-902-11	SPEAKER (15X6.5 CM)	
8	4-302-404-03	SCREW (WASHER HEAD) (+P 4X16)	
9	4-365-808-01	SCREW (5), TAPPING	
10	4-072-365-11	SPACER, DY	
11	* 3-704-372-11	HOLDER, HV CABLE	
12	Δ 8-738-812-05	PICTURE TUBE (A51LP70X)	
13	Δ 8-451-505-11	DEFLECTION YOKE (Y21RSA-S)	
14	* A-1331-900-A	C3 BOARD MOUNTED	
15	4-369-318-41	SPRING, TENSION	
16	Δ 1-416-946-21	COIL, DEMAGNETIC	
17	4-067-189-01	PWB(L), GUIDE	
18	4-067-187-01	PWB(R), GUIDE	
19	8-598-449-10	TUNER, FSS BTF-LG433	
20	Δ 1-453-293-11	TRANSFORMER ASSY, FLYBACK (NX-1748/M3A4)	
21	* A-1299-110-A	A BOARD COMPLETE	
22	4-057-714-01	PIECE ASSY, TLH CORRECTION	
23	4-022-115-21	HOLDER, AC CORD	
24	Δ 1-574-062-11	CORD, POWER (WITH CONNECTOR) 2.5A/250V	
25	1-452-032-00	MAGNET,DISC	
26	4-051-736-41	PIECE A(90), CONV, CORRECT	
27	* A-1342-491-A	VM1 BOARD MOUNTED	
28	4-067-167-01	BRACKET,TERMINAL	
29	4-074-017-11	SHEET, BLOTTING	
30	* A-1241-360-A	F BOARD MOUNTED	
31	8-453-011-31	NA299-S2	
32	X-4036-774-2	REAR COVER ASSY	
33	* 4-067-182-03	HOLDER, FBT	
34	4-064-883-11	HOLDER, DGC	
35	4-067-191-11	PANEL (R)	
36	4-067-193-01	PANEL (L)	
37	4-069-652-11	CUSHION (HS BAND)	
38	* 4-379-189-11	CUSHION, SPEAKER	

SECTION 7
ELECTRICAL PARTS LIST

A

NOTE:

The components identified by shading and mark \triangle are critical for safety. Replace only with part number specified.

When indicating parts by reference number, please include the board name.

- Items marked " * " are not stocked since they are seldom required for routine service. Some delay should be anticipated when ordering these items.
 - All resistors are in ohms
 - F : nonflammable
- CAPACITORS
- MF : μ F, PF : μ μ F
- COILS
- MMH : mH, UH : μ H

REF.NO.	PART NO.	DESCRIPTION	REMARK	REF.NO.	PART NO.	DESCRIPTION	REMARK
* A-1299-110-A	A BOARD COMPLETE	*****		C107	1-163-005-11	CERAMIC CHIP 470PF	10% 50V
* 4-055-304-11	HOLDER, LED			C108	1-104-664-11	ELECT 47MF	20% 16V
* 4-067-182-03	HOLDER, FBT			C109	1-163-005-11	CERAMIC CHIP 470PF	10% 50V
4-074-035-11	HEAT SINK (F)			C110	1-163-005-11	CERAMIC CHIP 470PF	10% 50V
4-352-844-01	PIN, LEAD, COATING			C111	1-163-005-11	CERAMIC CHIP 470PF	10% 50V
4-382-854-11	SCREW (M3X10), P, SW (+)			C112	1-104-664-11	ELECT 47MF	20% 16V
	<CAPACITOR>			C113	1-104-664-11	ELECT 47MF	20% 25V
C003	1-163-251-11	CERAMIC CHIP 100PF	5% 50V	C114	1-126-967-11	ELECT 47MF	20% 50V
C004	1-163-001-11	CERAMIC CHIP 220PF	10% 50V	C202	1-163-020-00	CERAMIC CHIP 0.0082MF	10% 50V
C005	1-163-001-11	CERAMIC CHIP 220PF	10% 50V	C203	1-163-020-00	CERAMIC CHIP 0.0082MF	10% 50V
C006	1-164-004-11	CERAMIC CHIP 0.1MF	10% 25V	C204	1-136-159-00	MYLAR 0.033MF	5% 50V
C007	1-104-664-11	ELECT 47MF	20% 16V	C205	1-164-182-11	CERAMIC CHIP 0.0033MF	10% 50V
C008	1-163-251-11	CERAMIC CHIP 100PF	5% 50V	C206	1-164-182-11	CERAMIC CHIP 0.0033MF	10% 50V
C010	1-163-251-11	CERAMIC CHIP 100PF	5% 50V	C207	1-136-159-00	MYLAR 0.033MF	5% 50V
C012	1-163-251-11	CERAMIC CHIP 100PF	5% 50V	C208	1-126-964-11	ELECT 10MF	20% 50V
C013	1-163-021-91	CERAMIC CHIP 0.01MF	10% 50V	C209	1-126-964-11	ELECT 10MF	20% 50V
C014	1-104-664-11	ELECT 47MF	20% 25V	C210	1-126-933-11	ELECT 100MF	20% 16V
C015	1-163-009-11	CERAMIC CHIP 0.001MF	10% 50V	C211	1-126-941-11	ELECT 470MF	20% 25V
C016	1-163-113-00	CERAMIC CHIP 68PF	5% 50V	C212	1-126-933-11	ELECT 100MF	20% 16V
C017	1-163-113-00	CERAMIC CHIP 68PF	5% 50V	C213	1-126-933-11	ELECT 100MF	20% 16V
C019	1-104-664-11	ELECT 47MF	20% 25V	C214	1-126-942-61	ELECT 1000MF	20% 25V
C022	1-163-227-11	CERAMIC CHIP 10PF	0.5PF 50V	C215	1-126-942-61	ELECT 1000MF	20% 25V
C023	1-163-227-11	CERAMIC CHIP 10PF	0.5PF 50V	C216	1-163-021-91	CERAMIC CHIP 0.01MF	10% 50V
C024	1-163-227-11	CERAMIC CHIP 10PF	0.5PF 50V	C217	1-126-964-11	ELECT 10MF	20% 50V
C026	1-164-004-11	CERAMIC CHIP 0.1MF	10% 25V	C218	1-136-167-00	MYLAR 0.15MF	5% 50V
C027	1-164-004-11	CERAMIC CHIP 0.1MF	10% 25V	C219	1-136-167-00	MYLAR 0.15MF	5% 50V
C028	1-163-037-11	CERAMIC CHIP 0.022MF	10% 50V	C220	1-126-942-61	ELECT 1000MF	20% 25V
C030	1-126-965-11	ELECT 22MF	20% 50V	C221	1-126-964-11	ELECT 10MF	20% 50V
C031	1-164-004-11	CERAMIC CHIP 0.1MF	10% 25V	C223	1-126-965-11	ELECT 22MF	20% 50V
C032	1-107-823-11	CERAMIC CHIP 0.47MF	10% 16V	C224	1-163-133-00	CERAMIC CHIP 470PF	5% 50V
C034	1-163-031-11	CERAMIC CHIP 0.01MF	50V	C225	1-109-982-11	CERAMIC CHIP 1MF	10% 10V
C041	1-163-251-11	CERAMIC CHIP 100PF	5% 50V	C226	1-109-982-11	CERAMIC CHIP 1MF	10% 10V
C042	1-163-251-11	CERAMIC CHIP 100PF	5% 50V	C227	1-163-037-11	CERAMIC CHIP 0.022MF	10% 50V
C043	1-163-251-11	CERAMIC CHIP 100PF	5% 50V	C228	1-163-024-00	CERAMIC CHIP 0.018MF	10% 50V
C044	1-163-251-11	CERAMIC CHIP 100PF	5% 50V	C229	1-163-018-00	CERAMIC CHIP 0.0056MF	10% 50V
C047	1-163-251-11	CERAMIC CHIP 100PF	5% 50V	C230	1-163-024-00	CERAMIC CHIP 0.018MF	10% 50V
C048	1-163-251-11	CERAMIC CHIP 100PF	5% 50V	C231	1-163-018-00	CERAMIC CHIP 0.0056MF	10% 50V
C050	1-163-251-11	CERAMIC CHIP 100PF	5% 50V	C232	1-163-037-11	CERAMIC CHIP 0.022MF	10% 50V
C051	1-163-251-11	CERAMIC CHIP 100PF	5% 50V	C233	1-164-004-11	CERAMIC CHIP 0.1MF	10% 25V
C053	1-163-251-11	CERAMIC CHIP 100PF	5% 50V	C234	1-164-004-11	CERAMIC CHIP 0.1MF	10% 25V
C054	1-163-251-11	CERAMIC CHIP 100PF	5% 50V	C235	1-164-004-11	CERAMIC CHIP 0.1MF	10% 25V
C055	1-163-251-11	CERAMIC CHIP 100PF	5% 50V	C236	1-164-004-11	CERAMIC CHIP 0.1MF	10% 25V
C103	1-164-004-11	CERAMIC CHIP 0.1MF	10% 25V	C238	1-164-505-11	CERAMIC CHIP 2.2MF	16V
C104	1-104-665-11	ELECT 100MF	20% 10V	C240	1-164-505-11	CERAMIC CHIP 2.2MF	16V
				C241	1-164-346-11	CERAMIC CHIP 1MF	16V
				C242	1-164-505-11	CERAMIC CHIP 2.2MF	16V
				C243	1-216-295-91	SHORT 0	
				C244	1-164-700-11	CERAMIC CHIP 0.68MF	16V

A

The components identified by shading and mark \triangle are critical for safety. Replace only with part number specified.

REF. NO.	PART NO.	DESCRIPTION	REMARK	REF. NO.	PART NO.	DESCRIPTION	REMARK
C245	1-164-346-11	CERAMIC CHIP 1MF	16V	C502	1-163-145-00	CERAMIC CHIP 0.0015MF	5% 50V
C246	1-163-018-00	CERAMIC CHIP 0.0056MF	10% 50V	C506	1-107-638-11	ELECT 33MF	20% 160V
C247	1-164-346-11	CERAMIC CHIP 1MF	16V	C507	1-161-830-00	CERAMIC 0.0047MF	500V
C248	1-163-010-11	CERAMIC CHIP 0.0012MF	10% 50V	C510	1-102-112-00	CERAMIC 330PF	10% 50V
C249	1-164-004-11	CERAMIC CHIP 0.1MF	10% 25V	C512	1-163-989-11	CERAMIC CHIP 0.033MF	10% 25V
C250	1-216-295-91	SHORT 0		C513	1-163-263-11	CERAMIC CHIP 330PF	5% 50V
C251	1-163-017-00	CERAMIC CHIP 0.0047MF	10% 50V	C514	1-106-383-00	MYLAR 0.047MF	10% 200V
C252	1-164-346-11	CERAMIC CHIP 1MF	16V	C517	1-164-182-11	CERAMIC CHIP 0.0033MF	10% 50V
C253	1-163-037-11	CERAMIC CHIP 0.022MF	10% 50V	C518	1-104-665-11	ELECT 100MF	20% 10V
C254	1-126-965-11	ELECT 22MF	20% 50V	C519	1-102-212-00	CERAMIC 820PF	10% 500V
C255	1-163-037-11	CERAMIC CHIP 0.022MF	10% 50V	C521	1-126-934-11	ELECT 220MF	20% 16V
C256	1-164-004-11	CERAMIC CHIP 0.1MF	10% 25V	C522	1-126-933-11	ELECT 100MF	20% 16V
C259	1-126-933-11	ELECT 100MF	20% 16V	C523	1-102-002-00	CERAMIC 680PF	10% 500V
C264	1-164-505-11	CERAMIC CHIP 2.2MF	16V	C524	1-126-967-11	ELECT 47MF	20% 50V
C265	1-164-505-11	CERAMIC CHIP 2.2MF	16V	C526	1-130-495-00	MYLAR 0.1MF	5% 50V
C301	1-126-935-11	ELECT 470MF	20% 16V	C527	1-102-820-00	CERAMIC 330PF	5% 50V
C302	1-163-005-11	CERAMIC CHIP 470PF	10% 50V	C528	1-162-134-11	CERAMIC 470PF	10% 2KV
C303	1-126-964-11	ELECT 10MF	20% 50V	C530	1-137-372-11	MYLAR 0.022MF	5% 50V
C304	1-126-967-11	ELECT 47MF	20% 50V	C531	1-126-961-11	ELECT 2.2MF	20% 50V
C305	1-164-004-11	CERAMIC CHIP 0.1MF	10% 25V	C532	1-126-941-11	ELECT 470MF	20% 25V
C306	1-163-233-11	CERAMIC CHIP 18PF	5% 50V	C533	1-126-941-11	ELECT 470MF	20% 25V
C307	1-163-233-11	CERAMIC CHIP 18PF	5% 50V	C536	1-136-165-00	MYLAR 0.1MF	5% 50V
C308	1-163-259-91	CERAMIC CHIP 220PF	5% 50V	C537	1-126-969-11	ELECT 220MF	20% 50V
C309	1-126-957-11	ELECT 0.22MF	20% 50V	C538	1-136-076-00	FILM 0.0085MF	3% 2KV
C310	1-126-963-11	ELECT 4.7MF	20% 50V	C539	1-129-746-91	FILM 0.039MF	5% 400V
C311	1-126-964-11	ELECT 10MF	20% 50V	C540	1-136-171-00	MYLAR 0.33MF	5% 50V
C312	1-164-346-11	CERAMIC CHIP 1MF	16V	C546	1-165-319-11	CERAMIC CHIP 0.1MF	50V
C313	1-164-346-11	CERAMIC CHIP 1MF	16V	C549	1-163-017-00	CERAMIC CHIP 0.0047MF	10% 50V
C315	1-164-004-11	CERAMIC CHIP 0.1MF	10% 25V	C550	1-106-220-00	MYLAR 0.1MF	10% 100V
C316	1-104-664-11	ELECT 47MF	20% 25V	C551	1-126-960-11	ELECT 1MF	20% 50V
C317	1-164-004-11	CERAMIC CHIP 0.1MF	10% 25V	C552	1-162-116-00	CERAMIC 680PF	10% 2KV
C318	1-163-031-11	CERAMIC CHIP 0.01MF	50V	C553	1-162-116-00	CERAMIC 680PF	10% 2KV
C319	1-163-031-11	CERAMIC CHIP 0.01MF	50V	C554	1-137-417-11	MYLAR 0.0047MF	10% 200V
C320	1-163-031-11	CERAMIC CHIP 0.01MF	50V	C556	1-126-941-11	ELECT 470MF	20% 25V
C322	1-163-005-11	CERAMIC CHIP 470PF	10% 50V	C557	1-126-941-11	ELECT 470MF	20% 25V
C324	1-163-017-00	CERAMIC CHIP 0.0047MF	10% 50V	C558	1-123-024-21	ELECT 33MF	160V
C325	1-126-960-11	ELECT 1MF	20% 50V	C560	1-102-228-00	CERAMIC 470PF	10% 500V
C327	1-126-965-11	ELECT 22MF	20% 50V	C561	1-129-708-91	FILM 0.0033MF	5% 630V
C328	1-164-004-11	CERAMIC CHIP 0.1MF	10% 25V	C562	1-102-228-00	CERAMIC 470PF	10% 500V
C330	1-164-004-11	CERAMIC CHIP 0.1MF	10% 25V	C564	1-163-038-91	CERAMIC CHIP 0.1MF	25V
C332	1-126-963-11	ELECT 4.7MF	20% 50V	C565	1-107-655-11	ELECT 47MF	20% 250V
C335	1-164-004-11	CERAMIC CHIP 0.1MF	10% 25V	C566	1-102-244-00	CERAMIC 220PF	10% 500V
C336	1-164-004-11	CERAMIC CHIP 0.1MF	10% 25V	C567	1-115-521-11	FILM 0.82MF	5% 250V
C337	1-126-961-11	ELECT 2.2MF	20% 50V	C568	1-102-228-00	CERAMIC 470PF	10% 500V
C338	1-163-017-00	CERAMIC CHIP 0.0047MF	10% 50V	C570	1-115-520-11	FILM 0.68MF	5% 250V
C341	1-115-340-11	CERAMIC CHIP 0.22MF	10% 25V	C573	1-106-379-12	MYLAR 0.033MF	10% 200V
C342	1-163-259-91	CERAMIC CHIP 220PF	5% 50V	C574	1-107-649-11	ELECT 2.2MF	20% 250V
C401	1-164-346-11	CERAMIC CHIP 1MF	16V	C576	1-130-495-00	MYLAR 0.1MF	5% 50V
C402	1-164-346-11	CERAMIC CHIP 1MF	16V	C577	1-106-395-00	MYLAR 0.15MF	10% 200V
C403	1-163-005-11	CERAMIC CHIP 470PF	10% 50V	C582	1-164-004-11	CERAMIC CHIP 0.1MF	10% 25V
C404	1-163-005-11	CERAMIC CHIP 470PF	10% 50V	C586	1-216-295-91	SHORT 0	
C405	1-126-935-11	ELECT 470MF	20% 16V	C600 \triangle	1-104-705-11	MYLAR 0.1MF	20% 250V
C406	1-164-346-11	CERAMIC CHIP 1MF	16V	C602 \triangle	1-104-705-11	MYLAR 0.1MF	20% 250V
C407	1-164-346-11	CERAMIC CHIP 1MF	16V	C604	1-163-009-11	CERAMIC CHIP 0.001MF	10% 50V
C408	1-163-133-00	CERAMIC CHIP 470PF	5% 50V	C605 \triangle	1-127-942-51	CERAMIC 330PF	10% 250V
C409	1-126-963-11	ELECT 4.7MF	20% 50V	C606 \triangle	1-127-942-51	CERAMIC 330PF	10% 250V
C415	1-163-133-00	CERAMIC CHIP 470PF	5% 50V				

The components identified by shading and mark \triangle are critical for safety.
Replace only with part number specified.

A

REF. NO.	PART NO.	DESCRIPTION	REMARK	REF. NO.	PART NO.	DESCRIPTION	REMARK
C607	1-161-830-00	CERAMIC	0.0047MF 99%	500V		<CONNECTOR>	
C608	1-161-830-00	CERAMIC	0.0047MF 99%	500V			
C609	1-126-968-11	ELECT	100MF 20%	50V	CN104	1-695-915-11	TAB (CONTACT)
C610	1-126-964-11	ELECT	10MF 20%	50V	CN202 *	1-785-608-11	PIN, CONNECTOR 4P
C611	1-161-830-00	CERAMIC	0.0047MF 99%	500V	CN203 *	1-564-506-11	PLUG, CONNECTOR 3P
C612	1-161-830-00	CERAMIC	0.0047MF 99%	500V	CN204 *	1-564-506-11	PLUG, CONNECTOR 3P
C613	1-117-752-11	ELECT(BLOCK)	330MF 20%	450V	CN305 *	1-564-509-11	PLUG, CONNECTOR 6P
C614	1-126-964-11	ELECT	10MF 20%	50V	CN306 *	1-564-510-11	PLUG, CONNECTOR 7P
C616	1-130-202-00	FILM	0.022MF 5%	400V	CN505	1-508-765-00	PIN, CONNECTOR (5MM PITCH) 3P
C617	1-107-792-11	CERAMIC	100PF 5%	1KV	CN506	4-352-844-01	PIN, LEAD, COATING
C618	1-125-893-11	FILM	680PF 3%	1.5KV	CN601 *	1-580-843-11	PIN, CONNECTOR (POWER)
C619 \triangle	1-119-892-51	CERAMIC	470PF 10%	250V	CN604 *	1-573-963-11	PIN, CONNECTOR (PC BOARD) 3P
C620	1-163-133-00	CERAMIC CHIP	470PF 5%	50V	CN609 *	1-508-784-21	PIN, CONNECTOR (5MM PITCH) 1P
C621	1-102-114-00	CERAMIC	470PF 10%	50V	CN901 *	1-564-507-11	PLUG, CONNECTOR 4P
C622	1-102-074-00	CERAMIC	0.001MF 10%	50V		<DIODE>	
C623	1-104-665-11	ELECT	100MF 20%	25V	D001	8-719-988-61	DIODE 1SS355TE-17
C624	1-104-331-11	CERAMIC	0.0022MF 10%	1KV	D005	8-719-988-61	DIODE 1SS355TE-17
C627	1-102-002-00	CERAMIC	680PF 10%	500V	D006	8-719-988-61	DIODE 1SS355TE-17
C628	1-126-942-61	ELECT	1000MF 20%	25V	D203	8-719-914-42	DIODE DA204K
C629	1-126-964-11	ELECT	10MF 20%	50V	D300	1-216-295-91	SHORT 0
C630	1-123-024-21	ELECT	33MF 160V		D301	8-719-988-61	DIODE 1SS355TE-17
C633	1-104-999-11	MYLAR	0.1MF 10%	200V	D306	8-719-988-61	DIODE 1SS355TE-17
C634	1-126-933-11	ELECT	100MF 20%	16V	D307	8-719-988-61	DIODE 1SS355TE-17
C635	1-104-665-11	ELECT	100MF 20%	10V	D308	8-719-988-61	DIODE 1SS355TE-17
C636	1-104-760-11	CERAMIC CHIP	0.047MF 10%	50V	D309	8-719-159-10	DIODE RD5.1SB-T2
C639	1-164-004-11	CERAMIC CHIP	0.1MF 10%	25V	D311	8-719-988-61	DIODE 1SS355TE-17
C640	1-164-004-11	CERAMIC CHIP	0.1MF 10%	25V	D312	8-719-988-61	DIODE 1SS355TE-17
C641	1-102-002-00	CERAMIC	680PF 10%	500V	D313	8-719-988-61	DIODE 1SS355TE-17
C642	1-126-943-11	ELECT	2200MF 20%	25V	D314	8-719-988-61	DIODE 1SS355TE-17
C643	1-104-665-11	ELECT	100MF 20%	10V	D315	8-719-988-61	DIODE 1SS355TE-17
C644	1-104-331-11	CERAMIC	0.0022MF 10%	1KV	D316	8-719-069-57	DIODE UDZS-TE17-6.8B
C645	1-137-605-11	MYLAR	0.01MF 10%	250V	D320	8-719-069-60	DIODE UDZS-TE17-9.1B
C646	1-107-679-41	ELECT	10MF 20%	450V	D321	8-719-069-60	DIODE UDZS-TE17-9.1B
C647	1-163-275-11	CERAMIC CHIP	0.001MF 5%	50V	D401	8-719-069-60	DIODE UDZS-TE17-9.1B
C649	1-126-940-11	ELECT	330MF 20%	25V	D402	8-719-158-35	DIODE RD9.1SB
C650	1-163-275-11	CERAMIC CHIP	0.001MF 5%	50V	D403	8-719-158-35	DIODE RD9.1SB
C651	1-163-133-00	CERAMIC CHIP	470PF 5%	50V	D404	8-719-069-60	DIODE UDZS-TE17-9.1B
C652	1-126-965-11	ELECT	22MF 20%	50V	D405	8-719-158-35	DIODE RD9.1SB
C653	1-126-967-11	ELECT	47MF 20%	50V	D406	8-719-158-35	DIODE RD9.1SB
C657	1-101-821-00	CERAMIC	0.0022MF 500V		D504	8-719-302-43	DIODE EL1Z
C658	1-164-004-11	CERAMIC CHIP	0.1MF 10%	25V	D505	8-719-988-61	DIODE 1SS355TE-17
C901	1-136-153-00	MYLAR	0.01MF 5%	50V	D506	8-719-911-19	DIODE 1SS119-25
C902	1-136-153-00	MYLAR	0.01MF 5%	50V	D507	8-719-988-61	DIODE 1SS355TE-17
C905	1-126-963-11	ELECT	4.7MF 20%	50V	D508	8-719-988-61	DIODE 1SS355TE-17
C906	1-164-346-11	CERAMIC CHIP	1MF 16V		D509	1-216-073-00	RES.CHIP 10K 5% 1/10W
C907	1-163-133-00	CERAMIC CHIP	470PF 5%	50V	D510	8-719-988-61	DIODE 1SS355TE-17
C908	1-163-133-00	CERAMIC CHIP	470PF 5%	50V	D511	8-719-988-61	DIODE 1SS355TE-17
C909	1-164-346-11	CERAMIC CHIP	1MF 16V		D512	8-719-988-61	DIODE 1SS355TE-17
C910	1-126-967-11	ELECT	47MF 20%	50V	D513	8-719-908-03	DIODE GP08D
C911	1-126-967-11	ELECT	47MF 20%	50V	D517	8-719-312-71	DIODE RS3FS
C912	1-164-004-11	CERAMIC CHIP	0.1MF 10%	25V	D518	8-719-900-26	DIODE ERD29-08J
C913	1-104-665-11	ELECT	100MF 20%	10V	D521	8-719-302-43	DIODE EL1Z
C914	1-163-133-00	CERAMIC CHIP	470PF 5%	50V	D522	8-719-302-43	DIODE EL1Z
					D523	8-719-302-43	DIODE EL1Z
					D527	8-719-908-03	DIODE GP08D

The components identified by shading
and mark \triangle are critical for safety.
Replace only with part number specified.

A

REF. NO.	PART NO.	DESCRIPTION	REMARK	REF. NO.	PART NO.	DESCRIPTION	REMARK
		<COIL>					
L002	1-414-856-11	INDUCTOR 10UH		Q306	8-729-216-22	TRANSISTOR 2SA1162-G	
L003	1-414-180-11	INDUCTOR 3.3UH		Q307	8-729-230-49	TRANSISTOR 2SC2712-YG	
L005	1-414-233-22	INDUCTOR CHIP 0UH		Q308	8-729-216-22	TRANSISTOR 2SA1162-G	
L101	1-414-856-11	INDUCTOR 10UH		Q312	8-729-216-22	TRANSISTOR 2SA1162-G	
L102	1-414-856-11	INDUCTOR 10UH		Q313	8-729-230-49	TRANSISTOR 2SC2712-YG	
L103	1-414-856-11	INDUCTOR 10UH		Q315	1-801-806-11	TRANSISTOR DTC144EKA-T146	
L104	1-414-856-11	INDUCTOR 10UH		Q315	8-729-421-19	TRANSISTOR UN2213	
L105	1-414-856-11	INDUCTOR 10UH		Q401	8-729-424-67	TRANSISTOR UN2216	
L204	1-414-856-11	INDUCTOR 10UH		Q402	8-729-424-67	TRANSISTOR UN2216	
L301	1-414-189-31	INDUCTOR 100UH		Q403	8-729-216-22	TRANSISTOR 2SA1162-G	
L302	1-414-185-41	INDUCTOR 22UH		Q404	8-729-216-22	TRANSISTOR 2SA1162-G	
L501	1-412-525-31	INDUCTOR 10UH		Q503	8-729-230-49	TRANSISTOR 2SC2712-YG	
L502	1-422-613-11	COIL, AIR CORE		Q505	8-729-931-45	TRANSISTOR IRF614	
L503	1-412-525-31	INDUCTOR 10UH		Q506	8-729-140-96	TRANSISTOR 2SD774-34	
L504	1-412-525-31	INDUCTOR 10UH		Q507	8-729-216-22	TRANSISTOR 2SA1162-G	
L505	1-412-525-31	INDUCTOR 10UH		Q509	8-729-230-49	TRANSISTOR 2SC2712-YG	
L506	1-412-525-31	INDUCTOR 10UH		Q511	8-729-048-07	TRANSISTOR 2SD2578-CA	
L507	1-459-111-00	INDUCTOR 10MMH		Q601	8-729-023-22	TRANSISTOR 2SD2114K	
L508	1-412-525-31	INDUCTOR 10UH		Q602	8-729-230-49	TRANSISTOR 2SC2712-YG	
L509	1-459-390-00	INDUCTOR 390UH		Q603	8-729-027-23	TRANSISTOR DTA114EKA-T146	
L510	1-416-972-11	COIL, HORIZONTAL LINEARITY		Q604	8-729-200-17	TRANSISTOR 2SA1091-O	
L513	1-412-552-11	INDUCTOR 2.2MMH		Q605	8-729-044-30	TRANSISTOR 2SK2845-LB102	
L515	1-459-104-00	COIL, WITH CORE		Q606	8-729-230-49	TRANSISTOR 2SC2712-YG	
L518	1-414-187-11	INDUCTOR 47UH		Q607	8-729-922-37	TRANSISTOR 2SD2144S-UVW	
L601	1-412-527-11	INDUCTOR 15UH		Q608	8-729-230-49	TRANSISTOR 2SC2712-YG	
L901	1-408-603-31	INDUCTOR 10UH		Q901	1-801-806-11	TRANSISTOR DTC144EKA-T146	
L902	1-408-603-31	INDUCTOR 10UH		Q902	1-801-806-11	TRANSISTOR DTC144EKA-T146	
L905	1-414-856-11	INDUCTOR 10UH				<RESISTOR>	
		<PHOTO COUPLER>		R001	1-414-233-22	INDUCTOR CHIP 0UH	
PH600 \triangle	8-749-924-35	PHOTO COUPLER ON3171-R		R002	1-216-025-91	RES,CHIP 100	5% 1/10W
				R003	1-216-295-91	SHORT 0	
				R004	1-216-025-91	RES,CHIP 100	5% 1/10W
				R005	1-216-025-91	RES,CHIP 100	5% 1/10W
		<IC LINK>		R007	1-216-295-91	SHORT 0	
PS200	1-532-675-21	LINK, IC 1.5A/150V		R008	1-216-065-91	RES,CHIP 4.7K	5% 1/10W
				R010	1-216-065-91	RES,CHIP 4.7K	5% 1/10W
				R011	1-216-065-91	RES,CHIP 4.7K	5% 1/10W
				R012	1-216-065-91	RES,CHIP 4.7K	5% 1/10W
		<TRANSISTOR>		R013	1-216-065-91	RES,CHIP 4.7K	5% 1/10W
Q002	8-729-230-49	TRANSISTOR 2SC2712-YG		R014	1-216-025-91	RES,CHIP 100	5% 1/10W
Q003	8-729-027-23	TRANSISTOR DTA114EKA-T146		R015	1-216-025-91	RES,CHIP 100	5% 1/10W
Q004	8-729-900-53	TRANSISTOR DTC114EK		R017	1-216-049-91	RES,CHIP 1K	5% 1/10W
Q101	8-729-230-49	TRANSISTOR 2SC2712-YG		R018	1-216-033-00	RES,CHIP 220	5% 1/10W
Q201	8-729-424-67	TRANSISTOR UN2216		R019	1-216-073-00	RES,CHIP 10K	5% 1/10W
Q202	8-729-424-67	TRANSISTOR UN2216		R021	1-216-073-00	RES,CHIP 10K	5% 1/10W
Q203	1-801-806-11	TRANSISTOR DTC144EKA-T146		R022	1-216-033-00	RES,CHIP 220	5% 1/10W
Q204	8-729-216-22	TRANSISTOR 2SA1162-G		R024	1-216-057-00	RES,CHIP 2.2K	5% 1/10W
Q205	1-801-806-11	TRANSISTOR DTC144EKA-T146		R025	1-216-057-00	RES,CHIP 2.2K	5% 1/10W
Q206	1-801-806-11	TRANSISTOR DTC144EKA-T146		R026	1-216-057-00	RES,CHIP 2.2K	5% 1/10W
Q207	1-801-806-11	TRANSISTOR DTC144EKA-T146		R027	1-216-073-00	RES,CHIP 10K	5% 1/10W
Q301	8-729-216-22	TRANSISTOR 2SA1162-G		R029	1-216-049-91	RES,CHIP 1K	5% 1/10W
Q302	8-729-230-49	TRANSISTOR 2SC2712-YG		R031	1-216-049-91	RES,CHIP 1K	5% 1/10W
Q303	8-729-216-22	TRANSISTOR 2SA1162-G		R035	1-216-025-91	RES,CHIP 100	5% 1/10W
Q305	8-729-216-22	TRANSISTOR 2SA1162-G		R036	1-216-025-91	RES,CHIP 100	5% 1/10W
				R037	1-216-025-91	RES,CHIP 100	5% 1/10W

A

REF. NO.	PART NO.	DESCRIPTION	REMARK	REF. NO.	PART NO.	DESCRIPTION	REMARK
R040	1-216-025-91	RES,CHIP	100 5% 1/10W	R303	1-216-049-91	RES,CHIP	1K 5% 1/10W
R041	1-216-025-91	RES,CHIP	100 5% 1/10W	R304	1-216-073-00	RES,CHIP	10K 5% 1/10W
R042	1-216-295-91	SHORT	0	R305	1-216-051-00	RES,CHIP	1.2K 5% 1/10W
R043	1-216-049-91	RES,CHIP	1K 5% 1/10W	R306	1-216-077-91	RES,CHIP	15K 5% 1/10W
R044	1-216-025-91	RES,CHIP	100 5% 1/10W	R308	1-216-025-91	RES,CHIP	100 5% 1/10W
R045	1-414-233-22	INDUCTOR CHIP	0UH	R309	1-216-025-91	RES,CHIP	100 5% 1/10W
R046	1-216-049-91	RES,CHIP	1K 5% 1/10W	R310	1-216-025-91	RES,CHIP	100 5% 1/10W
R047	1-414-233-22	INDUCTOR CHIP	0UH	R311	1-216-017-91	RES,CHIP	47 5% 1/10W
R048	1-216-073-00	RES,CHIP	10K 5% 1/10W	R312	1-216-041-00	RES,CHIP	470 5% 1/10W
R050	1-216-073-00	RES,CHIP	10K 5% 1/10W	R313	1-216-053-00	RES,CHIP	1.5K 5% 1/10W
R053	1-216-049-91	RES,CHIP	1K 5% 1/10W	R314	1-216-045-00	RES,CHIP	680 5% 1/10W
R055	1-216-073-00	RES,CHIP	10K 5% 1/10W	R316	1-216-053-00	RES,CHIP	1.5K 5% 1/10W
R056	1-216-073-00	RES,CHIP	10K 5% 1/10W	R317	1-216-077-91	RES,CHIP	15K 5% 1/10W
R061	1-216-033-00	RES,CHIP	220 5% 1/10W	R318	1-216-051-00	RES,CHIP	1.2K 5% 1/10W
R062	1-216-041-00	RES,CHIP	470 5% 1/10W	R319	1-216-025-91	RES,CHIP	100 5% 1/10W
R063	1-216-037-00	RES,CHIP	330 5% 1/10W	R320	1-216-065-91	RES,CHIP	4.7K 5% 1/10W
R064	1-216-037-00	RES,CHIP	330 5% 1/10W	R321	1-216-073-00	RES,CHIP	10K 5% 1/10W
R065	1-216-037-00	RES,CHIP	330 5% 1/10W	R322	1-216-033-00	RES,CHIP	220 5% 1/10W
R066	1-216-049-91	RES,CHIP	1K 5% 1/10W	R331	1-216-295-91	SHORT	0
R067	1-216-049-91	RES,CHIP	1K 5% 1/10W	R332	1-216-033-00	RES,CHIP	220 5% 1/10W
R105	1-216-295-91	SHORT	0	R333	1-216-073-00	RES,CHIP	10K 5% 1/10W
R109	1-216-041-00	RES,CHIP	470 5% 1/10W	R334	1-216-129-00	RES,CHIP	2.2M 5% 1/10W
R111	1-216-025-91	RES,CHIP	100 5% 1/10W	R335	1-216-045-00	RES,CHIP	680 5% 1/10W
R112	1-216-025-91	RES,CHIP	100 5% 1/10W	R338	1-216-033-00	RES,CHIP	220 5% 1/10W
R113	1-216-047-91	RES,CHIP	820 5% 1/10W	R340	1-216-025-91	RES,CHIP	100 5% 1/10W
R202	1-216-053-00	RES,CHIP	1.5K 5% 1/10W	R345	1-216-081-00	RES,CHIP	22K 5% 1/10W
R203	1-216-063-91	RES,CHIP	3.9K 5% 1/10W	R348	1-208-806-11	METAL CHIP	10K 0.50% 1/10W
R204	1-216-061-00	RES,CHIP	3.3K 5% 1/10W	R349	1-216-073-00	RES,CHIP	10K 5% 1/10W
R205	1-216-061-00	RES,CHIP	3.3K 5% 1/10W	R350	1-216-061-00	RES,CHIP	3.3K 5% 1/10W
R206	1-216-063-91	RES,CHIP	3.9K 5% 1/10W	R351	1-216-053-00	RES,CHIP	1.5K 5% 1/10W
R207	1-216-053-00	RES,CHIP	1.5K 5% 1/10W	R354	1-216-057-00	RES,CHIP	2.2K 5% 1/10W
R208	1-216-061-00	RES,CHIP	3.3K 5% 1/10W	R355	1-216-057-00	RES,CHIP	2.2K 5% 1/10W
R209	1-216-061-00	RES,CHIP	3.3K 5% 1/10W	R356	1-216-057-00	RES,CHIP	2.2K 5% 1/10W
R210	1-216-027-00	RES,CHIP	120 5% 1/10W	R357	1-216-079-00	RES,CHIP	18K 5% 1/10W
R212	1-216-027-00	RES,CHIP	120 5% 1/10W	R358	1-216-049-91	RES,CHIP	1K 5% 1/10W
R213	1-216-073-00	RES,CHIP	10K 5% 1/10W	R359	1-216-033-00	RES,CHIP	220 5% 1/10W
R214	1-216-073-00	RES,CHIP	10K 5% 1/10W	R360	1-216-033-00	RES,CHIP	220 5% 1/10W
R215	1-216-059-00	RES,CHIP	2.7K 5% 1/10W	R361	1-216-073-00	RES,CHIP	10K 5% 1/10W
R216	1-216-059-00	RES,CHIP	2.7K 5% 1/10W	R362	1-216-075-00	RES,CHIP	12K 5% 1/10W
R217	1-216-067-00	RES,CHIP	5.6K 5% 1/10W	R363	1-216-079-00	RES,CHIP	18K 5% 1/10W
R218	1-216-067-00	RES,CHIP	5.6K 5% 1/10W	R364	1-216-295-91	SHORT	0
R219	1-216-025-91	RES,CHIP	100 5% 1/10W	R365	1-216-033-00	RES,CHIP	220 5% 1/10W
R220	1-216-025-91	RES,CHIP	100 5% 1/10W	R366	1-216-073-00	RES,CHIP	10K 5% 1/10W
R221	1-216-295-91	SHORT	0	R367	1-216-073-00	RES,CHIP	10K 5% 1/10W
R222	1-216-295-91	SHORT	0	R370	1-216-033-00	RES,CHIP	220 5% 1/10W
R225	1-216-033-00	RES,CHIP	220 5% 1/10W	R376	1-216-081-00	RES,CHIP	22K 5% 1/10W
R226	1-216-033-00	RES,CHIP	220 5% 1/10W	R377	1-216-121-91	RES,CHIP	1M 5% 1/10W
R227	1-216-033-00	RES,CHIP	220 5% 1/10W	R378	1-216-031-00	RES,CHIP	180 5% 1/10W
R228	1-249-389-11	CARBON	4.7 5% 1/4W	R401	1-216-049-91	RES,CHIP	1K 5% 1/10W
R229	1-216-073-00	RES,CHIP	10K 5% 1/10W	R402	1-216-073-00	RES,CHIP	10K 5% 1/10W
R230	1-216-061-00	RES,CHIP	3.3K 5% 1/10W	R403	1-216-073-00	RES,CHIP	10K 5% 1/10W
R231	1-216-295-91	SHORT	0	R404	1-216-073-00	RES,CHIP	10K 5% 1/10W
R234	1-249-389-11	CARBON	4.7 5% 1/4W	R405	1-216-049-91	RES,CHIP	1K 5% 1/10W
R235	1-216-069-00	RES,CHIP	6.8K 5% 1/10W	R406	1-216-073-00	RES,CHIP	10K 5% 1/10W
R236	1-216-069-00	RES,CHIP	6.8K 5% 1/10W	R407	1-216-049-91	RES,CHIP	1K 5% 1/10W
R237	1-216-308-00	RES,CHIP	4.7 5% 1/10W	R408	1-216-049-91	RES,CHIP	1K 5% 1/10W
R301	1-216-073-00	RES,CHIP	10K 5% 1/10W	R409	1-216-041-00	RES,CHIP	470 5% 1/10W
R302	1-216-295-91	SHORT	0				

The components identified by shading
and mark Δ are critical for safety.
Replace only with part number specified.

A

REF. NO.	PART NO.	DESCRIPTION		REMARK	REF. NO.	PART NO.	DESCRIPTION		REMARK		
R410	1-216-113-00	RES,CHIP	470K	5%	1/10W	R573	1-216-089-91	RES,CHIP	47K	5%	1/10W
R411	1-216-113-00	RES,CHIP	470K	5%	1/10W	R577	1-215-913-11	METAL OXIDE	220	5%	3W F
R412	1-216-041-00	RES,CHIP	470	5%	1/10W	R578	1-216-369-00	METAL OXIDE	1	5%	2W F
R413	1-216-021-00	RES,CHIP	68	5%	1/10W	R579	1-216-097-91	RES,CHIP	100K	5%	1/10W
R414	1-216-113-00	RES,CHIP	470K	5%	1/10W	R580	1-208-830-11	METAL CHIP	100K	0.50%	1/10W
R415	1-216-113-00	RES,CHIP	470K	5%	1/10W	R581	1-208-794-11	METAL CHIP	3.3K	0.50%	1/10W
R416	1-216-077-91	RES,CHIP	15K	5%	1/10W	R585	1-249-391-11	CARBON	6.8	5%	1/4W F
R417	1-216-077-91	RES,CHIP	15K	5%	1/10W	R588	1-215-888-00	METAL OXIDE	220	5%	2W F
R418	1-216-113-00	RES,CHIP	470K	5%	1/10W	R589	1-215-888-00	METAL OXIDE	220	5%	2W F
R419	1-216-022-00	RES,CHIP	75	5%	1/10W	R590	1-215-465-00	METAL	68K	1%	1/4W
R426	1-216-033-00	RES,CHIP	220	5%	1/10W	R591	1-260-288-11	CARBON	0.47	5%	1/2W F
R505	1-216-099-00	RES,CHIP	120K	5%	1/10W	R593	1-260-288-11	CARBON	0.47	5%	1/2W F
R506	1-216-085-00	RES,CHIP	33K	5%	1/10W	R594	1-260-288-11	CARBON	0.47	5%	1/2W F
R507	1-249-389-11	CARBON	4.7	5%	1/4W F	R596	1-216-485-11	METAL OXIDE	5.6K	5%	3W F
R508	1-215-910-00	METAL OXIDE	68	5%	3W F	R597	1-247-750-11	CARBON	680	5%	1/2W F
R509	1-215-911-11	METAL OXIDE	100	5%	3W F	R598	1-249-438-11	CARBON	56K	5%	1/4W
R510	1-215-886-11	METAL OXIDE	100	5%	2W F	R599	1-249-389-11	CARBON	4.7	5%	1/4W
R511	1-215-911-11	METAL OXIDE	100	5%	3W F	R600	1-249-438-11	CARBON	56K	5%	1/4W
R516	1-216-081-00	RES,CHIP	22K	5%	1/10W	R601	1-249-418-11	CARBON	1.2K	5%	1/4W F
R518	1-247-807-31	CARBON	100	5%	1/4W	R602	1-249-389-11	CARBON	4.7	5%	1/4W F
R520	1-215-445-00	METAL	10K	1%	1/4W	R603	1-215-485-00	METAL	470K	1%	1/4W
R522	1-208-806-11	METAL CHIP	10K	0.50%	1/10W	R604	1-216-097-91	RES,CHIP	100K	5%	1/10W
R523	1-249-411-11	CARBON	330	5%	1/4W	R607	1-249-425-11	CARBON	4.7K	5%	1/4W
R525	1-208-830-11	METAL CHIP	100K	0.50%	1/10W	R608	1-240-205-91	CARBON	22M	5%	1/2W
R526	1-208-798-11	METAL CHIP	4.7K	0.50%	1/10W	R609	1-216-057-00	RES,CHIP	2.2K	5%	1/10W
R527	1-216-001-00	RES,CHIP	10	5%	1/10W	R610	1-216-073-00	RES,CHIP	10K	5%	1/10W
R528	1-208-814-91	METAL CHIP	22K	0.50%	1/10W	R611	1-216-089-91	RES,CHIP	47K	5%	1/10W
R529	1-208-766-11	METAL CHIP	220	0.50%	1/10W	R612	1-216-045-00	RES,CHIP	680	5%	1/10W
R531	1-247-843-11	CARBON	3.3K	5%	1/4W	R614	1-216-041-00	RES,CHIP	470	5%	1/10W
R533	1-249-417-11	CARBON	1K	5%	1/4W	R615	1-216-350-11	METAL OXIDE	1.2	5%	1W F
R534	1-216-361-21	METAL OXIDE	0.22	5%	2W F	R616	1-260-302-51	CARBON	6.8	5%	1/2W F
R535	1-216-067-00	RES,CHIP	5.6K	5%	1/10W	R617	1-247-791-91	CARBON	22	5%	1/4W
R536	1-216-067-00	RES,CHIP	5.6K	5%	1/10W	R619	1-260-128-11	CARBON	270K	5%	1/2W
R537	1-208-814-91	METAL CHIP	22K	0.50%	1/10W	R620	1-215-915-11	METAL OXIDE	470	5%	3W F
R540	1-216-065-91	RES,CHIP	4.7K	5%	1/10W	R622	1-215-908-00	METAL OXIDE	33	5%	3W F
R541	1-216-065-91	RES,CHIP	4.7K	5%	1/10W	R623	1-216-095-00	RES,CHIP	82K	5%	1/10W
R542	1-216-295-91	SHORT	0			R624	1-216-089-91	RES,CHIP	47K	5%	1/10W
R543	1-249-426-11	CARBON	5.6K	5%	1/4W F	R626	1-216-049-91	RES,CHIP	1K	5%	1/10W
R544	1-216-457-21	METAL OXIDE	1.2K	5%	2W F	R627	1-240-251-11	CMT,MELF	6.8	5%	10W
R545	1-216-077-91	RES,CHIP	15K	5%	1/10W	R629	1-247-747-11	CARBON	470	5%	1/2W F
R546	1-216-077-91	RES,CHIP	15K	5%	1/10W	R630	1-249-429-11	CARBON	10K	5%	1/4W F
R547	1-216-085-00	RES,CHIP	33K	5%	1/10W	R631	1-216-089-91	RES,CHIP	47K	5%	1/10W
R549	1-215-451-00	METAL	18K	1%	1/4W	R632	1-202-933-61	FUSIBLE	0.1	10%	1/2W F
R550	1-216-097-91	RES,CHIP	100K	5%	1/10W	R634 Δ	1-218-265-11	METAL	8.2M	5%	1W
R551	1-249-421-11	CARBON	2.2K	5%	1/4W	R635	1-216-492-21	METAL OXIDE	82K	5%	3W F
R552	1-216-057-00	RES,CHIP	2.2K	5%	1/10W	R636	1-215-924-00	METAL OXIDE	15K	5%	3W F
R553	1-215-457-00	METAL	33K	1%	1/4W	R637	1-216-492-21	METAL OXIDE	82K	5%	3W F
R554	1-215-457-00	METAL	33K	1%	1/4W	R639	1-216-363-00	METAL OXIDE	0.33	5%	2W F
R556	1-215-437-00	METAL	4.7K	1%	1/4W	R640	1-249-415-11	CARBON	680	5%	1/4W
R558	1-249-421-11	CARBON	2.2K	5%	1/4W	R641	1-216-362-11	METAL OXIDE	0.27	5%	2W F
R559	1-249-429-11	CARBON	10K	5%	1/4W	R642	1-249-419-11	CARBON	1.5K	5%	1/4W
R560	1-216-073-00	RES,CHIP	10K	5%	1/10W	R643	1-247-843-11	CARBON	3.3K	5%	1/4W
R562	1-249-401-11	CARBON	47	5%	1/4W	R644	1-249-419-11	CARBON	1.5K	5%	1/4W
R565	1-216-073-00	RES,CHIP	10K	5%	1/10W	R646	1-215-924-00	METAL OXIDE	15K	5%	3W F
R567	1-216-105-91	RES,CHIP	220K	5%	1/10W	R647	1-249-401-11	CARBON	47	5%	1/4W
R568	1-249-383-11	CARBON	1.5	5%	1/4W F	R648	1-216-057-00	RES,CHIP	2.2K	5%	1/10W
R570	1-216-069-00	RES,CHIP	6.8K	5%	1/10W	R649	1-249-417-11	CARBON	1K	5%	1/4W
R571	1-215-437-00	METAL	4.7K	1%	1/4W						

A

C₃

The components identified by shading and mark Δ are critical for safety. Replace only with part number specified.

REF. NO.	PART NO.	DESCRIPTION	REMARK
R650	1-215-882-00	METAL OXIDE 22	5% 2W F
R652	1-215-900-11	METAL OXIDE 22K	5% 2W F
R653	1-215-873-00	METAL OXIDE 4.7K	5% 1W F
R657	1-260-127-11	CARBON 220K	5% 1/2W
R659	1-216-049-91	RES,CHIP 1K	5% 1/10W
R660	1-216-073-00	RES,CHIP 10K	5% 1/10W
R661	1-215-873-00	METAL OXIDE 4.7K	5% 1W F
R680	1-216-308-00	RES,CHIP 4.7	5% 1/10W
R901	1-249-411-11	CARBON 330	5% 1/4W
R902	1-249-411-11	CARBON 330	5% 1/4W
R903	1-216-022-00	RES,CHIP 75	5% 1/10W
R904	1-216-033-00	RES,CHIP 220	5% 1/10W
R905	1-216-113-00	RES,CHIP 470K	5% 1/10W
R906	1-216-077-91	RES,CHIP 15K	5% 1/10W
R907	1-216-113-00	RES,CHIP 470K	5% 1/10W
R908	1-216-077-91	RES,CHIP 15K	5% 1/10W
R909	1-216-065-91	RES,CHIP 4.7K	5% 1/10W
R910	1-216-065-91	RES,CHIP 4.7K	5% 1/10W
R911	1-216-067-00	RES,CHIP 5.6K	5% 1/10W
R912	1-216-041-00	RES,CHIP 470	5% 1/10W
R913	1-216-049-91	RES,CHIP 1K	5% 1/10W
R914	1-216-055-00	RES,CHIP 1.8K	5% 1/10W
R915	1-216-061-00	RES,CHIP 3.3K	5% 1/10W
R916	1-216-017-91	RES,CHIP 47	5% 1/10W
R917	1-216-041-00	RES,CHIP 470	5% 1/10W
R918	1-216-041-00	RES,CHIP 470	5% 1/10W
		<RELAY>	
RY601 Δ	1-755-299-11	RELAY	
		<SWITCH>	
S502	1-572-707-11	SWITCH, LEVER	
S600 Δ	1-571-433-21	SWITCH, PUSH (AC POWER)	
S901	1-692-431-21	SWITCH, TACTILE	
S902	1-692-431-21	SWITCH, TACTILE	
S903	1-692-431-21	SWITCH, TACTILE	
S904	1-692-431-21	SWITCH, TACTILE	
S905	1-692-431-21	SWITCH, TACTILE	
S906	1-692-431-21	SWITCH, TACTILE	
S907	1-692-431-21	SWITCH, TACTILE	
		<TRANSFORMER>	
T501	1-437-195-11	TRANSFORMER, HORIZONTAL DRIVE	
T503 Δ	1-453-293-11	FBT ASSY, NX-1748/M3A4	
T601	1-424-682-11	TRANSFORMER, LINE FILTER	
T603 Δ	1-433-513-31	TRANSFORMER, CONVERTER (SRT)	
T604 Δ	1-431-852-11	TRANSFORMER, CONVERTER (SRT)	
		<THERMISTOR>	
THP600	1-810-961-11	THERMISTOR, POSITIVE	

REF. NO.	PART NO.	DESCRIPTION	REMARK
		<TUNER>	
TU101	8-598-449-10	TUNER, FSS BTF-LG433 (KV-HF21M80)	
		<CRYSTAL>	
X001	1-579-125-11	VIBRATOR, CERAMIC	
X301	1-781-134-21	VIBRATOR, CRYSTAL	
X302	1-781-132-21	VIBRATOR, CRYSTAL	

	* A-1331-900-A	C3 BOARD MOUNTED	*****
	7-682-948-01	SCREW +PSW 3X8	
		<CAPACITOR>	
C701	1-162-114-00	CERAMIC 0.0047MF	2KV
C702	1-102-074-00	CERAMIC 0.001MF	10% 50V
C703	1-107-651-11	ELECT 4.7MF	20% 250V
C704	1-130-202-00	FILM 0.022MF	5% 400V
C706	1-104-664-11	ELECT 47MF	20% 16V
C708	1-102-114-00	CERAMIC 470PF	10% 50V
C709	1-102-114-00	CERAMIC 470PF	10% 50V
C710	1-102-114-00	CERAMIC 470PF	10% 50V
C712	1-102-116-00	CERAMIC 680PF	10% 50V
C713	1-102-116-00	CERAMIC 680PF	10% 50V
C714	1-102-116-00	CERAMIC 680PF	10% 50V
C716	1-126-933-11	ELECT 100MF	20% 16V
C717	1-101-880-00	CERAMIC 47PF	5% 50V
C736	1-102-114-00	CERAMIC 470PF	10% 50V
C737	1-102-114-00	CERAMIC 470PF	10% 50V
C746	1-102-114-00	CERAMIC 470PF	10% 50V
		<CONNECTOR>	
CN701	1-508-765-00	PIN, CONNECTOR (5MM PITCH) 3P	
CN702	1-695-915-11	TAB (CONTACT)	
CN703 *	1-564-509-11	PLUG, CONNECTOR 6P	
CN704	1-695-915-11	TAB (CONTACT)	
		<DIODE>	
D701	8-719-911-19	DIODE 1SS119-25	
D702	8-719-911-19	DIODE 1SS119-25	
D703	8-719-911-19	DIODE 1SS119-25	
D707	8-719-911-19	DIODE 1SS119-25	
D708	8-719-911-19	DIODE 1SS119-25	
D709	8-719-911-19	DIODE 1SS119-25	
D710	8-719-911-19	DIODE 1SS119-25	
D711	8-719-911-19	DIODE 1SS119-25	
D712	8-719-911-19	DIODE 1SS119-25	
D713	8-719-911-19	DIODE 1SS119-25	

The components identified by shading and mark Δ are critical for safety. Replace only with part number specified.

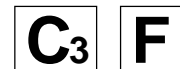

REF. NO.	PART NO.	DESCRIPTION	REMARK
D714	8-719-911-19	DIODE 1SS119-25	
D715	8-719-911-19	DIODE 1SS119-25	
D716	8-719-911-19	DIODE 1SS119-25	
D717	8-719-121-26	DIODE RD9.1ESL2	
<JACK>			
J701	Δ 1-540-071-22	SOCKET, CRT	
<COIL>			
L701	1-410-667-31	INDUCTOR 22UH	
L710	1-408-613-31	INDUCTOR 68UH	
L711	1-408-613-31	INDUCTOR 68UH	
L712	1-408-613-31	INDUCTOR 68UH	
<TRANSISTOR>			
Q704	8-729-326-11	TRANSISTOR 2SC2611	
Q705	8-729-326-11	TRANSISTOR 2SC2611	
Q706	8-729-326-11	TRANSISTOR 2SC2611	
Q707	8-729-200-17	TRANSISTOR 2SA1091-O	
Q708	8-729-200-17	TRANSISTOR 2SA1091-O	
Q709	8-729-200-17	TRANSISTOR 2SA1091-O	
Q710	8-729-119-78	TRANSISTOR 2SC2785-HFE	
Q711	8-729-119-78	TRANSISTOR 2SC2785-HFE	
Q712	8-729-119-78	TRANSISTOR 2SC2785-HFE	
<RESISTOR>			
R703	1-249-496-11	CARBON 100K	5% 1/2W
R705	1-216-380-11	METAL OXIDE 8.2	5% 2W F
R706	1-215-417-00	METAL 680	1% 1/4W
R707	1-215-413-00	METAL 470	1% 1/4W
R708	1-216-379-21	METAL OXIDE 6.8	5% 2W F
R710	1-215-922-11	METAL OXIDE 6.8K	5% 3W F
R711	1-247-752-11	CARBON 1K	5% 1/2W
R712	1-215-922-11	METAL OXIDE 6.8K	5% 3W F
R713	1-247-752-11	CARBON 1K	5% 1/2W
R714	1-215-922-11	METAL OXIDE 6.8K	5% 3W F
R715	1-247-752-11	CARBON 1K	5% 1/2W
R719	1-215-480-00	METAL 300K	1% 1/4W
R720	1-249-923-11	CARBON 1K	5% 1/4W F
R721	1-215-489-00	METAL 680K	1% 1/4W
R722	1-249-923-11	CARBON 1K	5% 1/4W F
R723	1-215-479-00	METAL 270K	1% 1/4W
R724	1-249-923-11	CARBON 1K	5% 1/4W F
R725	1-249-421-11	CARBON 2.2K	5% 1/4W
R726	1-249-421-11	CARBON 2.2K	5% 1/4W
R727	1-249-421-11	CARBON 2.2K	5% 1/4W
R728	1-249-407-11	CARBON 150	5% 1/4W
R729	1-249-407-11	CARBON 150	5% 1/4W
R730	1-249-407-11	CARBON 150	5% 1/4W
R731	1-249-407-11	CARBON 150	5% 1/4W
R732	1-249-407-11	CARBON 150	5% 1/4W
R733	1-249-406-11	CARBON 120	5% 1/4W
R734	1-247-739-11	CARBON 100	5% 1/2W
R738	1-247-807-31	CARBON 100	5% 1/4W

REF. NO.	PART NO.	DESCRIPTION	REMARK
R739	1-247-807-31	CARBON 100	5% 1/4W
R740	1-247-807-31	CARBON 100	5% 1/4W
R755	1-249-418-11	CARBON 1.2K	5% 1/4W
R756	1-249-418-11	CARBON 1.2K	5% 1/4W
R757	1-249-418-11	CARBON 1.2K	5% 1/4W
<VARIABLE RESISTOR>			
RV702	1-241-656-21	RES, ADJ, METAL FILM 110M	

	* A-1241-360-A	F BOARD MOUNTED	*****
	1-533-223-11	CLIP, FUSE	
	4-044-778-11	COVER, CAP TYPE CONDENSER	
<CAPACITOR>			
C654	Δ 1-117-703-11	CERAMIC 0.0047MF	99% 250V
C4602	Δ 1-104-708-11	MYLAR 0.47MF	20% 250V
<CONNECTOR>			
CN4601	* 1-580-843-11	PIN, CONNECTOR (POWER)	
CN4602	* 1-580-843-11	PIN, CONNECTOR (POWER)	
CN4603	1-695-915-11	TAB (CONTACT)	
<FUSE>			
F4601	Δ 1-532-237-00	FUSE, TIME-LAG (BET) 3.15A/250V	
<RESISTOR>			
R4601	Δ 1-202-719-00	SOLID 1M	10% 1/2W
<TRANSFORMER>			
T4601	1-424-682-11	TRANSFORMER, LINE FILTER	
<VARISTOR>			
VDR461	1-803-830-31	VARISTOR (ERZV14D621)	



The components identified by shading and mark Δ are critical for safety. Replace only with part number specified.

REF. NO.	PART NO.	DESCRIPTION	REMARK
* A-1342-491-A	VM1 BOARD MOUNTED	*****	
4-382-854-11	SCREW (M3X10), P, SW (+)		
	<CAPACITOR>		
C5902	1-104-661-91	ELECT 330MF 20% 16V	
C5903	1-161-830-00	CERAMIC 0.0047MF 500V	
C5905	1-126-925-11	ELECT 470MF 20% 10V	
C5906	1-130-491-00	MYLAR 0.047MF 5% 50V	
C5907	1-107-638-11	ELECT 33MF 20% 160V	
C5908	1-106-383-00	MYLAR 0.047MF 10% 200V	
C5909	1-126-933-11	ELECT 100MF 20% 16V	
C5910	1-130-471-00	MYLAR 0.001MF 5% 50V	
C5911	1-107-949-11	ELECT 2.2MF 20% 160V	
C5912	1-104-999-11	MYLAR 0.1MF 10% 200V	
C5913	1-130-471-00	MYLAR 0.001MF 5% 50V	
C5914	1-126-933-11	ELECT 100MF 20% 16V	
C5916	1-130-491-00	MYLAR 0.047MF 5% 50V	
C5917	1-126-925-11	ELECT 470MF 20% 10V	
C5918	1-115-341-51	CERAMIC 120PF 10% 500V	
C5920	1-126-964-11	ELECT 10MF 20% 50V	
C5921	1-101-888-00	CERAMIC 68PF 5% 50V	
	<CONNECTOR>		
CN5901*	1-564-510-11	PLUG, CONNECTOR 7P	
CN5904*	1-770-723-11	CONNECTOR, BOARD TO BOARD 8P	
	<DIODE>		
D5901	8-719-911-19	DIODE 1SS119-25	
D5902	8-719-110-88	DIODE RD39ESB2	
D5903	8-719-911-19	DIODE 1SS119-25	
D5904	8-719-110-88	DIODE RD39ESB2	
D5905	8-719-911-19	DIODE 1SS119-25	
D5906	1-249-406-11	CARBON 120 5% 1/4W	
D5907	1-249-406-11	CARBON 120 5% 1/4W	
	<COIL>		
L5901	1-414-187-11	INDUCTOR 47UH	
L5902	1-414-856-11	INDUCTOR 10UH	
	<TRANSISTOR>		
Q5901	8-729-230-45	TRANSISTOR 2SC2458-YGR	
Q5902	8-729-809-26	TRANSISTOR 2SA1606-E	
Q5903	8-729-230-45	TRANSISTOR 2SC2458-YGR	
Q5905	8-729-230-45	TRANSISTOR 2SC2458-YGR	
Q5906	8-729-809-29	TRANSISTOR 2SC4159-E	
Q5908	8-729-119-78	TRANSISTOR 2SC2785-HFE	
Q5909	8-729-119-78	TRANSISTOR 2SC2785-HFE	
	<RESISTOR>		

REF. NO.	PART NO.	DESCRIPTION	REMARK
R5901	1-247-815-91	CARBON 220 5% 1/4W	
R5902	1-249-414-11	CARBON 560 5% 1/4W	F
R5903	1-247-735-11	CARBON 47 5% 1/2W	F
R5904	1-249-411-11	CARBON 330 5% 1/4W	
R5905	1-249-417-11	CARBON 1K 5% 1/4W	
R5906	1-249-417-11	CARBON 1K 5% 1/4W	
R5907	1-249-417-11	CARBON 1K 5% 1/4W	
R5908	1-249-383-11	CARBON 1.5 5% 1/4W	F
R5909	1-247-815-91	CARBON 220 5% 1/4W	
R5910	1-249-403-11	CARBON 68 5% 1/4W	
R5911	1-249-439-11	CARBON 68K 5% 1/4W	
R5912	1-249-437-11	CARBON 47K 5% 1/4W	
R5914	1-249-403-11	CARBON 68 5% 1/4W	
R5915	1-249-429-11	CARBON 10K 5% 1/4W	
R5916	1-249-419-11	CARBON 1.5K 5% 1/4W	
R5917	1-249-416-11	CARBON 820 5% 1/4W	
R5918	1-249-429-11	CARBON 10K 5% 1/4W	
R5919	1-249-417-11	CARBON 1K 5% 1/4W	F
R5920	1-249-439-11	CARBON 68K 5% 1/4W	
R5921	1-215-912-11	METAL OXIDE 150 5% 3W	F
R5922	1-249-414-11	CARBON 560 5% 1/4W	
R5923	1-249-383-11	CARBON 1.5 5% 1/4W	F
R5925	1-249-401-11	CARBON 47 5% 1/4W	F
R5929	1-215-880-00	METAL OXIDE 10 5% 2W	F
R5930	1-249-413-11	CARBON 470 5% 1/4W	
R5931	1-249-413-11	CARBON 470 5% 1/4W	
R5932	1-249-413-11	CARBON 470 5% 1/4W	
R5933	1-249-413-11	CARBON 470 5% 1/4W	
R5934	1-249-430-11	CARBON 12K 5% 1/4W	
R5935	1-249-429-11	CARBON 10K 5% 1/4W	

MISCELLANEOUS

- Δ 1-416-946-21 COIL, DEMAGNETIC
- Δ 1-416-946-11 COIL, DEGAUSS
- 1-452-032-00 MAGNET, DISC
- 1-503-902-11 SPEAKER (15X6.5 CM)
- 1-503-902-11 SPEAKER, LOUD (15X6.5CM) (KV-HF21M80)
- 1-540-005-31 CAP ASSY, HIGH VOLTAGE
- Δ 1-575-023-11 CORD, POWER (WITH CONNECTOR) 6A/250V
- 1-574-062-11 CORD, POWER
- Δ 8-451-505-11 DEFLECTION YOKE (Y21RSA-S)
- 8-453-011-31 NA299-S2
- Δ 8-738-812-05 PICTURE TUBE (A51LPT70X)

<u>REF. NO.</u>	<u>PART NO.</u>	<u>DESCRIPTION</u>	<u>REMARK</u>	<u>REF. NO.</u>	<u>PART NO.</u>	<u>DESCRIPTION</u>	<u>REMARK</u>
ACCESSORIES AND PACKING MATERIALS							

	1-501-372-81	ANTENNA, TELESCOPIC					
	1-417-151-21	MATCHING TRANSFORMER, ANTENNA					
	1-767-609-11	VIBRATOR, CERAMIC					
	3-701-910-00	SCREW, SPECIAL (DIA. 3.8X20)					
	3-866-918-11	MANUAL, INSTRUCTION					
	4-392-004-11	CLIP					
	4-392-003-21	BAND, HOLDING					
	4-069-044-01	COVER, BATTERY					
	* 4-062-162-11	BAG, PROTECTION					
	* 4-073-910-01	INDIVIDUAL CARTON					
	* 4-073-911-01	CUSHION (UPPER)(ASSY)					
	* 4-073-914-01	CUSHION (LOWER)(ASSY)					

REMOTE COMMANDER							

	1-418-163-11	REMOTE COMMANDER (RM-952)					
	9-939-697-01	BATTERY COVER, REMOTE COMMANDER					

