

OWNER'S MANUAL

PYLE

IN DASH 7 INCH MONITOR DVD/ CD/MP3/TV & RADIO RECEIVER

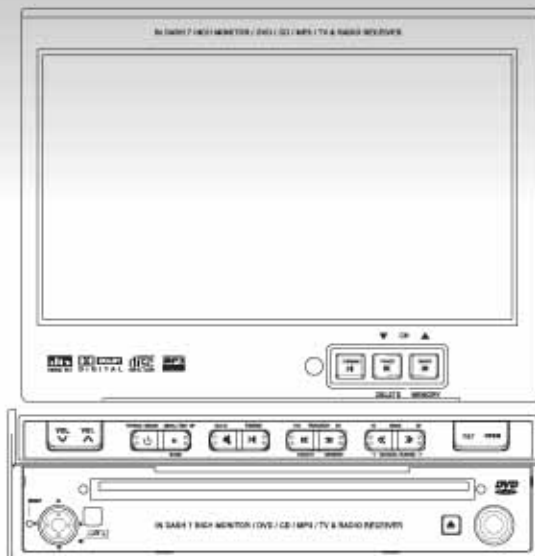

MODEL. PLTVD7IN

Any changes or modifications in construction of this device which is not expressly approved by the party responsible for compliance could void the user's authority to operate the equipment.

"Warning : Do not watch TV while vehicle in Motion it Can be Hazardous"

Safety precaution

WARNING

For your safety, the driver should not watch the TV or operate the controls while driving. Please note that watching and operating the TV while driving are prohibited by law in some countries. Also, while driving, keep the volume to a level at which external sounds can be heard.

To prevent injury or fire, take the following precautions:

Insert the unit all the way in until it is fully locked in place. Otherwise it may fall out of place when jolted.

When extending the ignition, battery, or ground wire, make sure to use automotive-grade wires or other wires with a 0.75mm^2 (AWG18) to prevent wire deterioration and damage to the wire coating.

To prevent a short circuit, never put or leave any metallic objects (such as coins or metal tools) inside the unit and don't hold the LCD Screen panel while it is opening or closing until it is completely opened or closed. Otherwise, the motorized mechanism will be damaged.

If the unit starts to emit smoke or strange smells, turn off the power immediately and consult your **PYLE** dealer.

Be careful not to drop the unit or subject it to strong shock. The unit may break or crack because it contains glass parts.

CAUTION

To prevent damage to the Unit, take the following precautions:

Make sure to ground the unit to a negative 12V DC power supply.

Do not open the top or bottom covers of the unit.

Do not install the unit in a spot exposed to direct sunlight or excessive heat or humidity. Also avoid places with too much dust or the possibility of water splashing.

When replacing a fuse, only use a new one with the prescribed rating. Using a fuse with the wrong rating may cause your unit to malfunction.

To prevent a short circuit when replacing a fuse, first disconnect the wiring harness.

Do not use your own screws. Use only the screws provided. If you use the wrong screw, You could damage the unit.

Do not load 3-inch CDs in the CD slot

If you try to load a 3-inch CD with its adapter into the unit, the adapter might separate from the CD and damage the unit.

CONTENTS

Safety Precaution (p4)

About CDs (p5)

Introduction (p6)

1. Region Number (p6)
2. Control Parts (p6)
 - 2-1. With Display Closed (p7)
 - 2-2. With Display Opened (p8)
3. Head unit Rear Panel (p9)
4. Battery (p10)
5. Remote Control key (p11)

Connecting to Power & Multi Channel AV Control Unit System (P12)

1. Connecting to power system (p12)
 - 1-1. Head unit
 - 1-2. RT Box (Multi Channel AV Control Unit System) (p13)
2. Connecting to Multi Channel AV Control Unit System (p14)
3. Connecting DVD/CD Changer Control System (p15)
4. Connecting to Multi Channel AV Control Unit System with Additional 6CH Amplifier (p16)

Basic Operation (p17~18)

1. Power ON/OFF..... (p17)
 2. Opening the TFT LCD Panel
 3. To Change Password
 4. Closing the Monitor
 5. Picture Control
 6. Audio Control (p18)
 7. Pre Adjust (Color System) (p19)
 8. Pre Adjust (Adjust TV System)
 9. Pre Adjust (Adjust Radio System) (p20)
 10. Pre Adjust (Adjust Sound Mix)
 11. Pre Adjust (Adjust Rear CCD) (p22)
 12. Rear Monitor
 13. Auto Tilt System (p23)
 14. Tuning (TV-Auto Search) (p24)
 15. Tuning (Radio-Auto Search)
-
1. Changing DVD System Setting (p26)
 2. Basic Playback (p27)
 3. Last Memory & Others (p32)

Safety precaution

The marking of products using lasers (Except for some areas)

**CLASS 1
LASER PRODUCT**

The label is attached to the chassis / case and says that the component uses laser beams that have been classified as Class 1. It means that the unit is utilizing laser beams that are of a weaker class. There is no danger of hazardous radiation outside the unit.

NOTE

If you experience problems during installation, consult your **PYLE** dealer.

If the unit fails to operate properly, press the Reset button. The unit returns to factory setting when the Reset button is pressed. If the unit still fails to operate properly after the Reset button has been pressed, contact your local **PYLE** dealer for assistance.

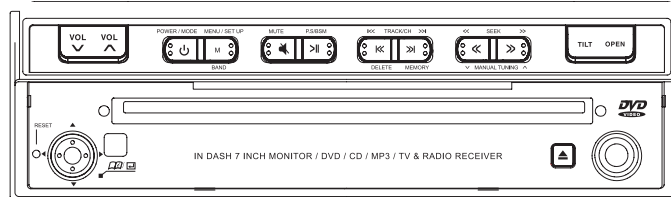

The illustrations of the display and the panel appearing in this manual are examples used to explain more clearly how the controls are used. Therefore, what appears on the display on the actual equipment, and some of the illustrations on the display may represent something impossible in actual operation.

Lens Fogging

Right after you turn on the car heater in cold weather, dew or condensation may form on the lens in the DVD player of the unit. Called lens fogging, CDs may be impossible to play. In such a situation, remove the disc and wait for the condensation to evaporate. If the unit still does not operate normally after a while, consult your **PYLE** dealer.

Safety precaution

Cleaning the Faceplate terminals

If the terminals on the unit or faceplate get dirty, wipe them with a dry, soft cloth.

Cleaning the Unit

If the front panel of this unit is stained, wipe it with a dry soft cloth such as a silicon cloth. If the front panel is stained badly, wipe the stain off with a cloth moistened with neutral cleaner, and then wipe neutral detergent off.



Applying spray cleaner directly to the unit may affect its mechanical parts. Wiping the front panel with a hard cloth or using a volatile liquid such as thinner or alcohol may scratch the surface or erase characters.

Cleaning the CD Slot



As dust tends to accumulate in the CD slot, clean it every once in a while. Your CDs can get scratched if you put them in a dusty CD slot.

About CDs

Handling CDs

- Don't touch the recording surface of the CD.

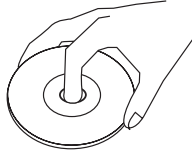

- CD-R and CD-RW are easier to damage than a normal music CD. Use a CD-R or a CD-RW after reading the caution items on the package etc.
- Don't stick tape etc. on the CD. Also, don't use a CD with tape stuck on it.

When using a new CD

If the CD center hole or outside rim has burrs, use it after removing them with a ball-point pen etc.

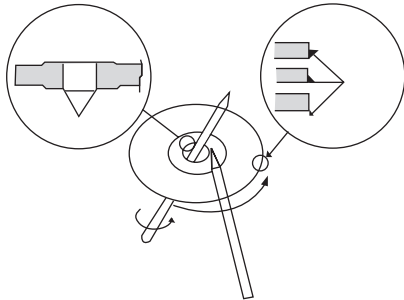

CD accessories

Don't use disc type accessories.

CD cleaning

Clean from the center of the disc and move outward.

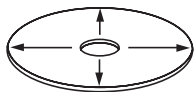

Removing CDs

When removing CDs from this unit, pull them out horizontally.

CDs that can't be used

- CDs that aren't round can't be used.

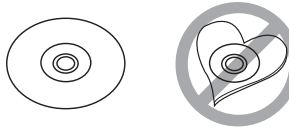

- CDs with coloring on the recording surface or that are dirty can't be used.
- This unit can only play the CDs with



It may not correctly play disks which do not have the mark as above.

- A CD-R or CD-RW that hasn't been finalized can't be played. (For the finalization process, refer to your CD-R/CD-RW writing software, and your CD-R/CD-RW recorder instruction manual.)

CD storage

- Don't place them in direct sunlight (On the seat or dashboard etc.) and where the temperature is high.
- Store CDs in their cases.



With the screen open, a driver may not see the disc insertion slot. For your safety, insert a disc with the screen closed.

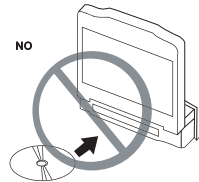

INTRODUCTION

Notice. "DVD Logo" is a trademark of DVD Format/Logo Licensing Corporation

1. Region Number



The region number of this Unit is labeled on the rear panel of the unit.

Most DVD's are manufactured specifically for sale and use in a specific geographic region.

A disc's Region Number must correspond to the Region Number of this Unit. If the Region Number of a disc is different from the Region Number of the this Unit, playback will not be possible.

This DVD Player is designed for use in Region 1 (North America).

If a disc is identified as "Region 0" it will work on any DVD Player.

2. Control Parts

2-1 With Display Closed

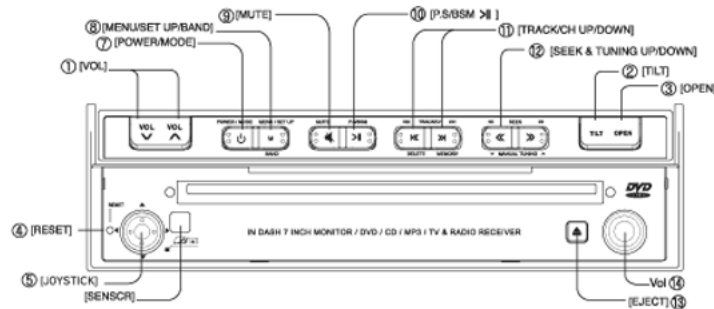

WITH THE DISPLAY CLOSED

- ① Volume Up/Down
Use this button to increase/decrease the volume.
- ② Tilt
Use this button to adjust the angle of the TFT LCD panel in 3 steps and every time this button is pressed with being held for about 2 second or longer, the TFT LCD panel moves backward with 2 steps & forward with 1 step.
- ③ Open/Close
Use this button to Open/Close the TFT LCD Panel. Press Open button about 2 Seconds or longer and then, the TFT LCD Panel Should be horizontally held for controlling an equipment like air conditioner in car. And it Should be returned to last position after 10 Seconds automatically.
- ④ Reset
Use this button when the unit fails to operate properly or return to default (Initial Mode).
- ⑤ Joy Stick
Check all functions with UP/DOWN/LEFT/RIGHT for System menu and Press enter key.
- ⑥ Remote Sensor
Remote Control infrared sensor.
- ⑦ Power/Mode
Use this button to turn on/off. For Turn -off, hold this button about 2 seconds or longer. And use this button to switch the modes such as AV1,AV2, DVD, Radio,TV.
- ⑧ Menu/Setup/Band
 - Menu: Use this button to display menu stored on DVD disc.
 - Setup: Use this button to show DVD SETUP MENU with holding this button about 2 seconds or longer.
 - Band: Use this button to switch receiving bands for radio (FM1, FM2, FM3, AM1, AM2) & TV(TV1, TV2).
- ⑨ Mute
Use this button to mute the sound.
- ⑩ P.S/BSM
Use this button for preset scan and press again to continue receiving that station in the radio mode. And press this button about 2 seconds for storing up FM/AM stations that are automatically tuned in sequentially.

INTRODUCTION

- ⑩ Track/CH Up/Down
- Use this button to tune to a station to be stored in the radio/TV mode .
 - 1) Track up key with pressing over 2 seconds should be Radio Frequency or TV Channel memory.
 - 2) Track down key with pressing over 2 seconds should delete Radio Frequency or TV Channel to be memorized.
 - Use this button to select a track in audio CD, MP3.
 - Use this button to select a chapter in the DVD video.
- ⑪ Seek & Tuning Up/Down
- Radio Mode: The unit starts to seek next station.
 - TV Mode: Use this button to seek TV Channel.
 - Disc Mode: Hold down to perform fast-forward and fast-backward on disc. Press and hold this button to switch the Seek/Manual Tuning Mode.
- ⑫ Eject
- Use this button to eject a disc in slot.
- ⑬ Vol
- Use this button to increase/decrease Volume.

2-2 WITH THE DISPLAY OPENED

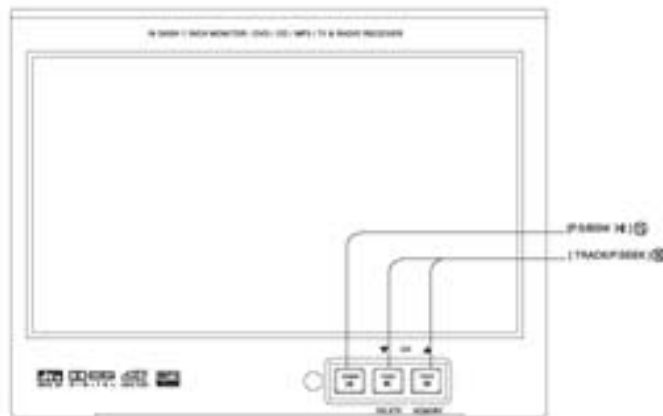

- ⑭ P.S/BSM
- Same as ⑩
- ⑮ Track (CH) Up/Down
- Use this button to select the next higher or lower preset station channel in the Radio and TV mode. In disc mode, Track/Chapter Up/Down function will be worked by this button.

3. HEAD UNIT REAR PANEL

1 16 Pin Connector

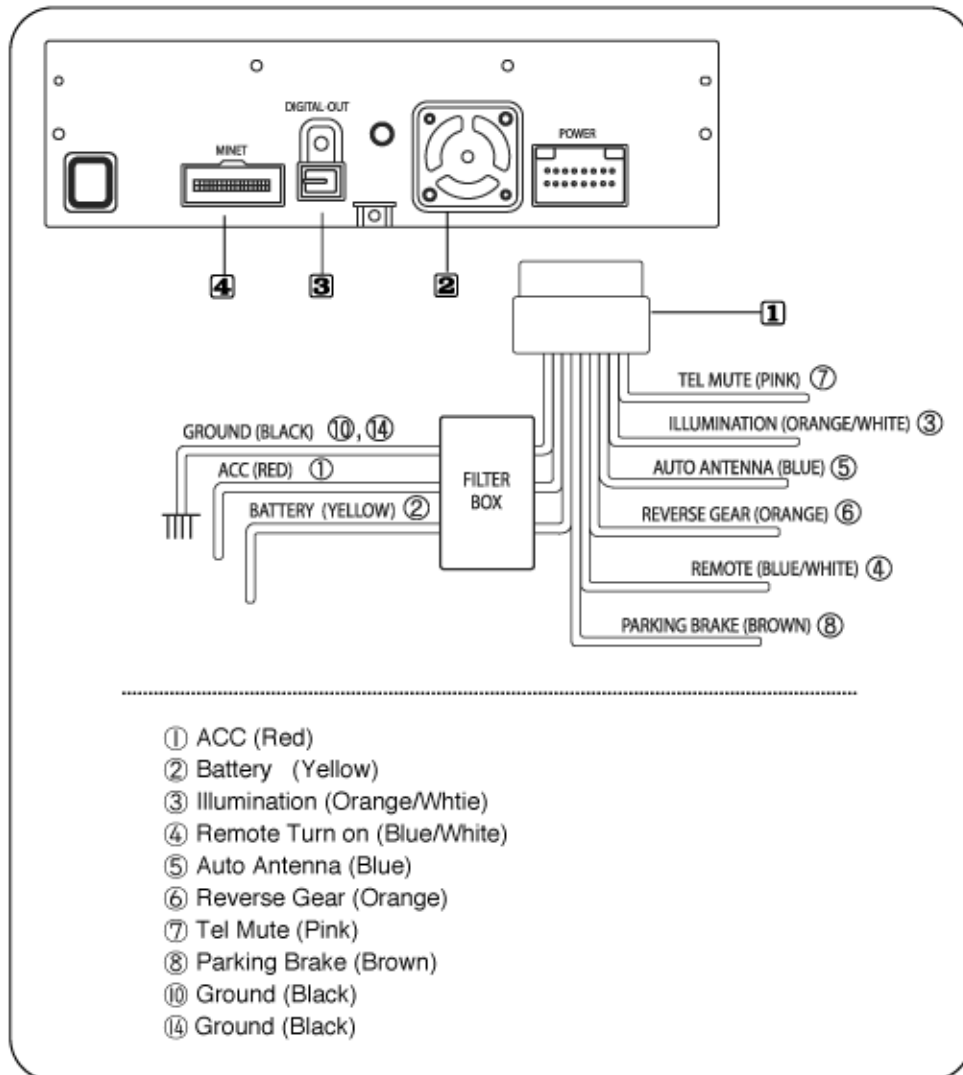

- 2 Cooling Fan
- 3 Digital Out
- 4 Minnet (For RT Box)

4. BATTERY

Preparing & Using The Remote Control

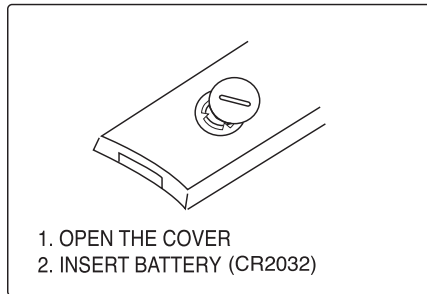

The remote control should be pointed at the remote sensor in order for the Unit Monitor to function correctly.

Distance: Maximum of 16 feet from the front of the remote sensor.

Angle: Approximately +/-30 from center.

Please do not locate the Unit where direct sunlight or fluorescent illumination might shine directly at the remote sensor. This will interfere with proper remote control operation.

BATTERY INSTALLATION

NOTICE (BATTERY)

PLEASE FOLLOW THE INSTRUCTIONS BELOW. INCORRECT BATTERY USEAGE MIGHT CAUSE EARLY DISCHARGE, LEAKAGE OR CORROSION DAMAGE.

- * Do not insert battery in the wrong direction. Be sure to observe the correct polarity (+/-) as indicated in the battery compartment.
- * It is dangerous to charge/heat/open or short circuitry the battery.
- * Please remove the battery in case of not using the remote control for a long period of time.
- * It is time to replace the battery if the remote control does not work properly or if the operating range becomes reduced.
- * Should battery leakage occur, clean the battery compartment with a soft cloth and replace with a new battery.

USING THE REMOTE CONTROL

NOTICE (REMOTE CONTROL)

- * The remote control should be aimed directly towards the remote sensor of the Unit.
- * Avoid dropping the remote control.
- * Avoid spilling liquids on the remote control or exposing it to extreme heat.

5. Remote Control Key

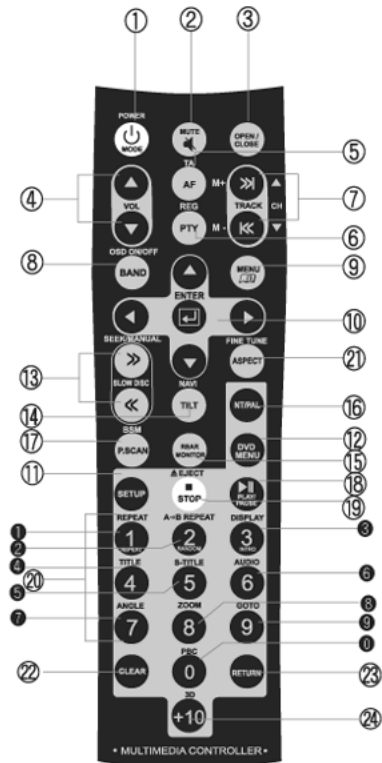

- ① Power/Mode
- ② Mute
- ③ Open/Close
- ④ Volume Up/Down
- ⑤ AF/TA (RDS Function)
- ⑥ PTY/ REG (RDS Function)
- ⑦ Track (P.Seek/CH) Up/Down
- ⑧ Band (OSD ON/OFF)
- ⑨ Menu
- ⑩ Enter
- ⑪ Set Up
- ⑫ DVD Menu
- ⑬ Slow Disc (Seek/Manual) Up/Down
- ⑭ Tilt/Navi (Navigation Function)
- ⑮ Rear Monitor
- ⑯ NTSC/PAL(DVD ONLY)
- ⑰ P.S/BSM
- ⑱ Play/Pause
- ⑲ Stop/Eject
- ⑳ Numeric Key Pad
- ❶ Repeat
- ❷ A-B Repeat (Random in CD Changer)
- ❸ Display (Intro in CD Changer)
- ❹ Title
- ❺ S-Title
- ❻ Audio
- ❼ Angle
- ❽ Zoom
- ❾ Goto
- ❿ PBC
- ⓫ Aspect, Fine Tune
- ⓬ Clear
- ⓭ Return
- ⓮ +10 (3D)

Connecting to Power & Multi Channel AV Control Unit System

1. Connecting to Power System

The illustration below is showing power system connection. Please also refer to the owner's and installation manuals supplied with the associated equipment. If it doesn't have corrected connection, it may cause unexpected damage.

1-1. HEAD UNIT

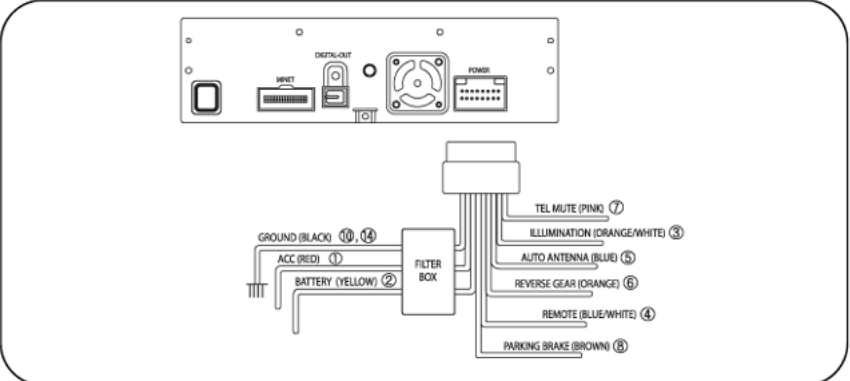

Notice

- Make sure the connection of Parking Brake wire. If it has no connection, the unit will not show any picture.
- Connect the Dimmer wire, otherwise its illumination on button will not be lit.
- When using the optional power amplifier, connect to Amplifier's power control terminal with Power Control Wire.
- Depending on what antenna you are using, connect auto antenna wire either to the control terminal of the motor antenna or to the power terminal for the film-type antenna.

1-2. RT BOX (Multi Channel AV Control Unit System)

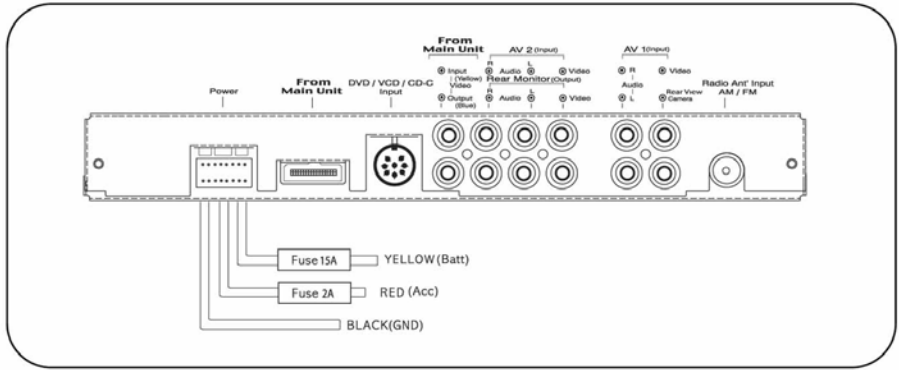

Connecting to Power & Multi Channel AV Control Unit System

2. RT BOX 16P CONNECTOR WIRING DIAGRAM

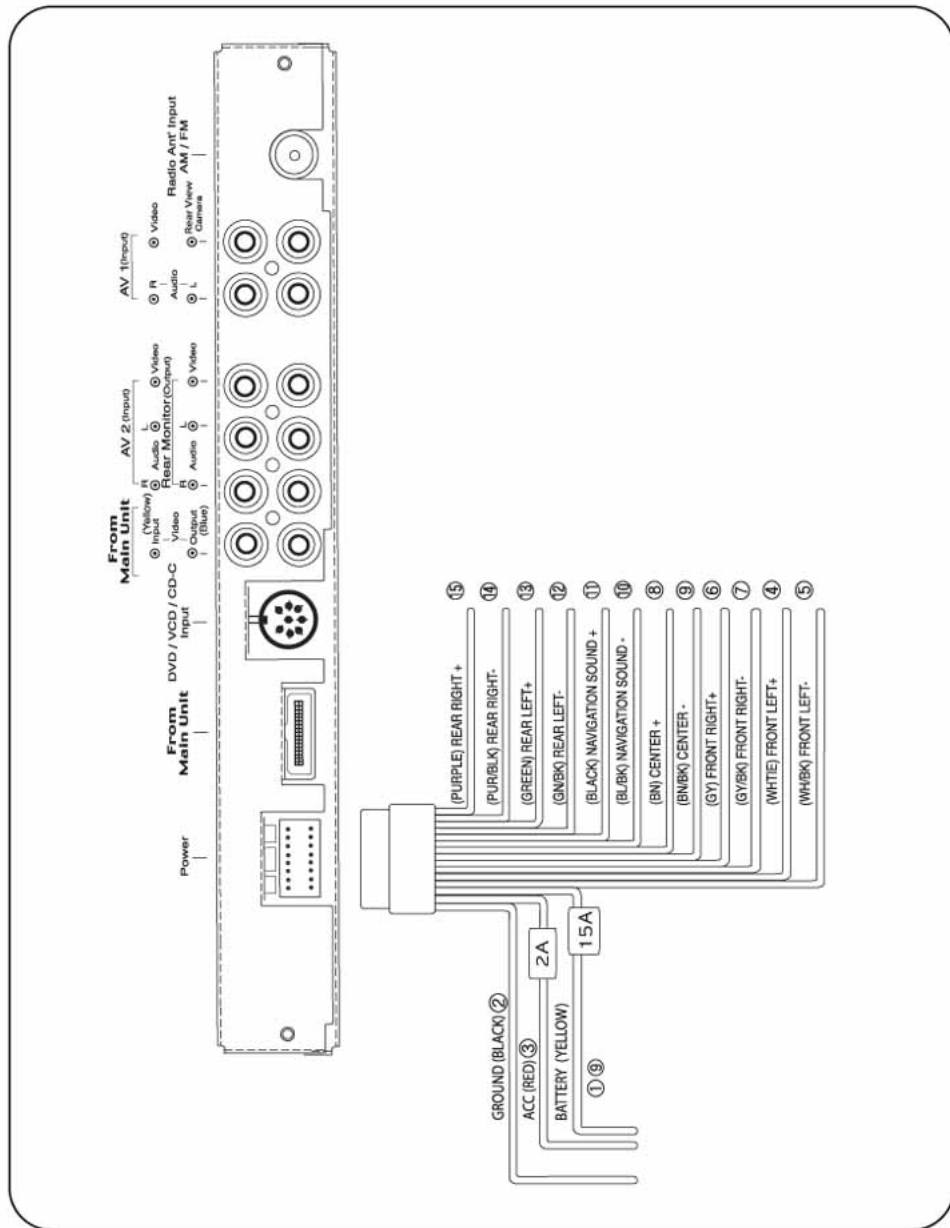

Connecting to Power & Multi Channel AV Control Unit System

3. Connecting to Multi Channel AV Control Unit System

The Illustration below is just possible examples with our Multi Channel AV Control Unit System only. The exact connection method will vary depending on the specific components selected for a particular installation.

Please also refer to the owner's and installation manuals supplied with the associated equipment.

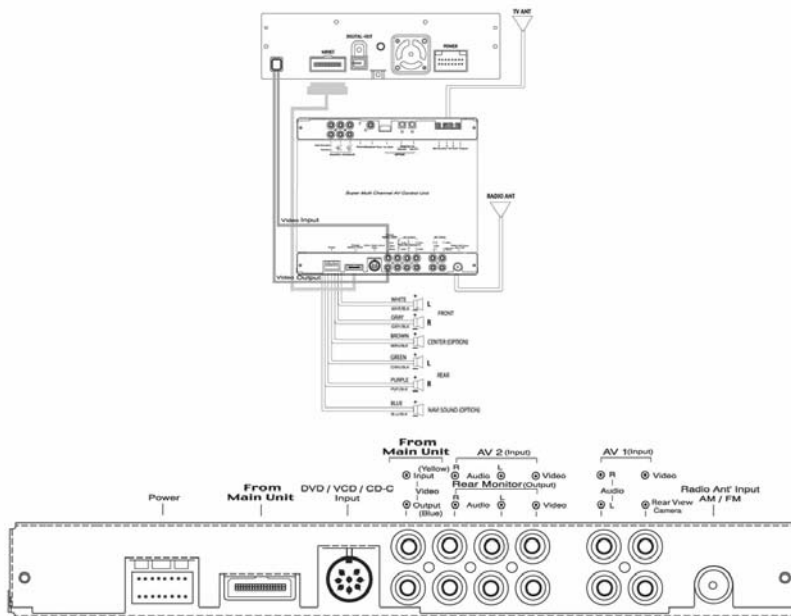

- ※ Don't use both AV2 and DVD/VCD Changer Input at the same time because it is linked each other. It can be used either only for AV2 or only for DVD/VCD Changer Input.

NOTICE

- Make sure that power is off before making signal connections.
- Connect this Unit Mi-Net output directly to the Mi-Net input of the RT BOX.
- In Case of Using Sub woofer, you must use additional Power Amplifier with Sub woofer Line out.

WARNING

Do not use the Digital Audio Output of this Unit unless you are connecting it to a suitable Dolby Digital and/or DTS decoder or to an amplifier equipped with a digital audio input. High volume digital signals may damage your equipment and your hearing.

Connecting to Power & Multi Channel AV Control Unit System

4. Connecting to DVD Changer Control System

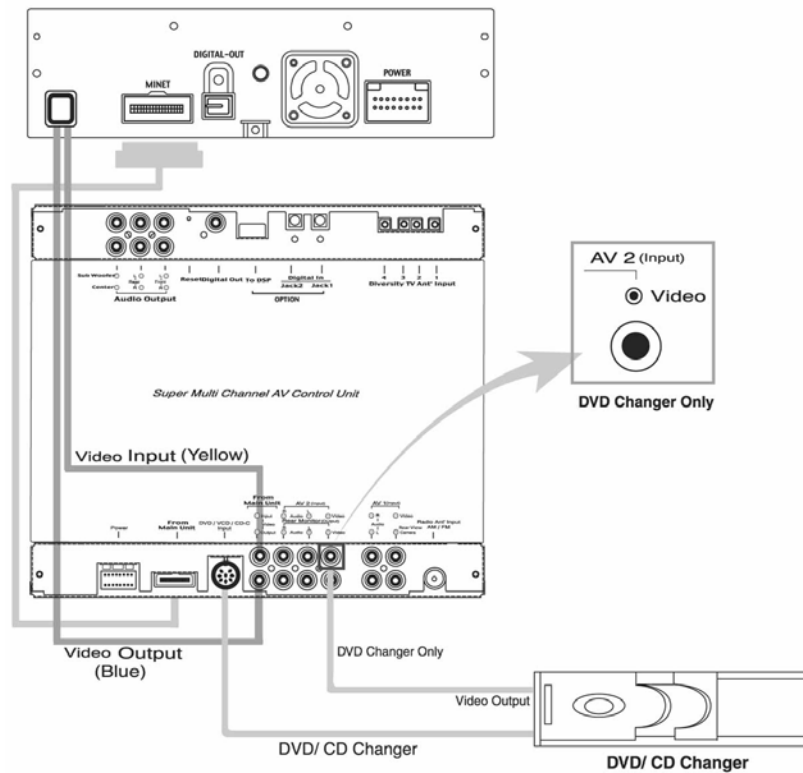

- ※ • Don't use AV2 Audio L/R input of RT Box when DVD Changer is Connected.
 - You can just use only AV2 Video input of RT Box from DVD Changer Video output.
 - In case of using CD Changer instead of DVD Changer, the AV2 of RT Box can not be availed.

Connecting to Power & Multi Channel AV Control Unit System

5. Connecting to Multi Channel AV Control Unit System with Additional 6CH Amplifier

The Illustration below is just possible examples for our Multi Channel AV Control Unit System with Additional 6CH Amplifier. The exact connection method will vary depending on the specific components selected for a particular installation.

Please also refer to the owner's and installation manuals supplied with the associated equipment.

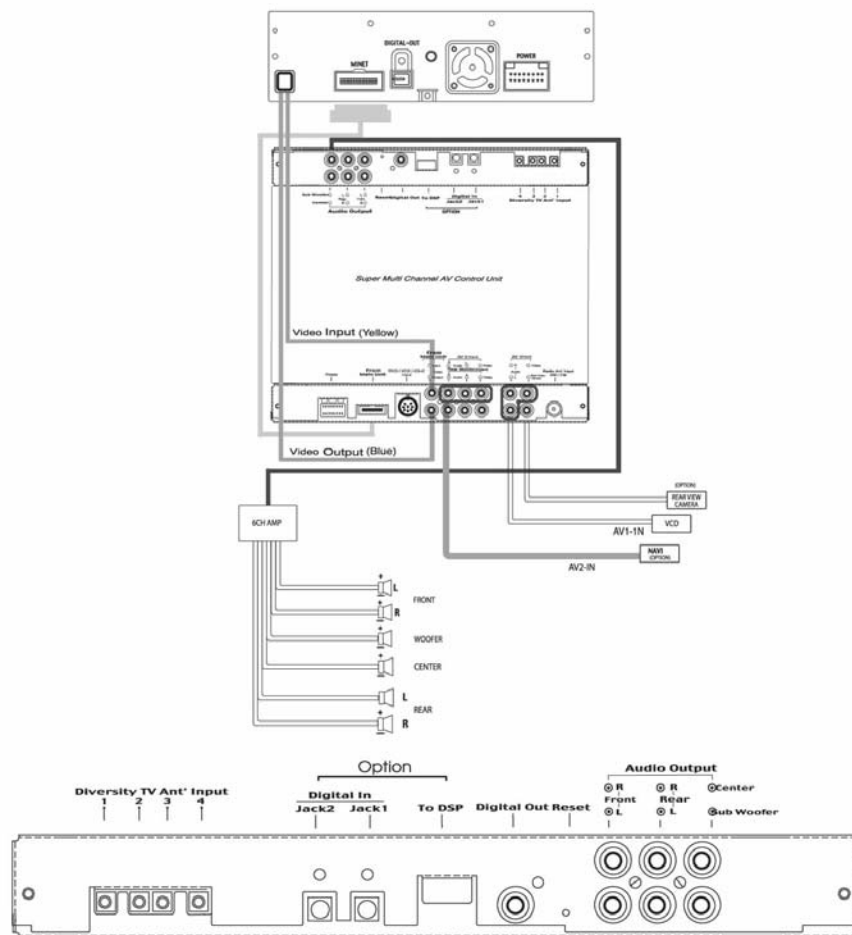

NOTE

In case of wanting more powerful 5.1CH sound system, you have to add additional power Amplifier of 6CH or 5CH+1CH.

BASIC OPERATION

POWER ON/OFF

1. POWER ON

- 1) Press POWER button to turn the power on and the monitor will be automatically positioned vertically when the monitor is opened.
2. You can also turn the power on by pressing the OPEN button. The power will be turned on and the monitor will be opened.

2. POWER OFF

- 1) Press the POWER button again to turn the power off over 2 seconds.
- 2) If you turn the power off by pressing the POWER button with the monitor open, the monitor will close. If the car key is pulled out, or the OPEN button is pressed, the monitor will automatically close.

OPENING THE TFT LCD PANEL

Press OPEN/CLOSE button or power button and then the monitor will open.

NOTE

If the OPEN/CLOSE button is pressed when the monitor is closed and the power is off, the monitor will open and the power will turn on.

CLOSING THE MONITOR

1. Hold the left and right upper side of the monitor parallel with the front of the unit as the picture below.



2. Press OPEN button or POWER button, and then the monitor will be closed.

NOTE

1. If the left and right angle of the monitor is not parallel to the front of the unit, the monitor cannot be closed.
2. If the OPEN button is pressed while radio or video is on, the monitor will close. But the sound will stay on. Press the POWER button to turn the sound off.

PICTURE CONTROL

1. Press MENU key until the monitor displays following picture.

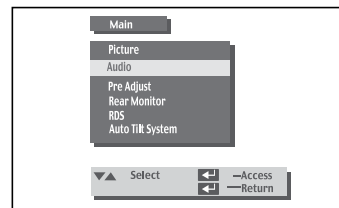

2. Use ▲▼ key and place cursor (Yellowbar) on Picture and press ENTER key.

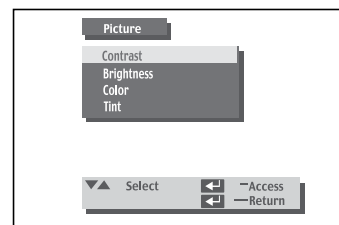

BASIC OPERATION

- Use ▲ ▼ key and place cursor (Yellow bar) on the item you want to adjust (Ex. Contrast) and press ENTER key as picture above.
- Press ◀ ▶ key to adjust the level of the selected item as picture below.

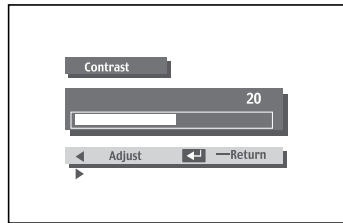

- Press ENTER key at least for 2 seconds to return to the previous menu.

* When no key is pressed for 5 seconds, the menu will disappear.

- Do the same process as above to adjust Brightness, Color and Tint.
- Press ENTER key at least for 2 seconds on current screen to return to the previous screen. Press Menu key about 1 second to turn MENU off directly.

AUDIO CONTROL

- Press MENU key until the monitor displays following picture.

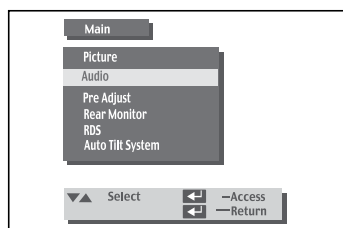

- Use ▲ ▼ Key and place cursor (Yellow Bar) on Audio and Press ENTER key.

- Use ▲ ▼ key and place cursor (Yellow bar) on the item you want to adjust (Ex. Tone/Volume) and press ENTER key as picture below.

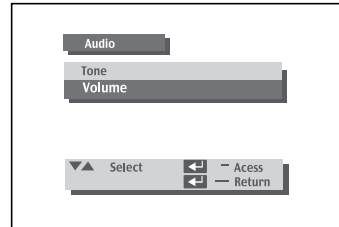

- Use ▲ ▼ key and place cursor (Yellow bar) on the sub-item you want to adjust (Ex. Bass) and press ENTER key as picture below

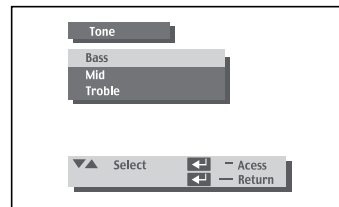

- Press ◀ ▶ key to adjust the level of the selected item as picture below.

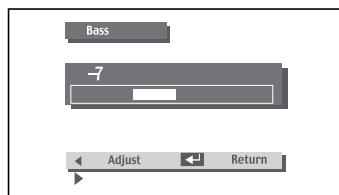

- Press ENTER key at least for 2 seconds to return to the previous menu.

* When no key is pressed for 5 seconds, the menu will disappear.

- Bass/Mid/Treble can be adjusted from -14 level to +14 level.

BASIC OPERATION

- Do the same process as above to adjust Volume.
- Press ENTER key at least for 2 seconds on current screen to return to the previous screen. Press Menu key about 1 second to turn MENU off directly.
- Do the same process as above to adjust Navigation, Auto Dimmer and Beep Tone.
- Navigation, Auto Dimmer and Beep Tone will be turned on and off by pressing ENTER key.

PRE ADJUST - (COLOR SYSTEM)

- Press MENU key until the monitor displays following picture.

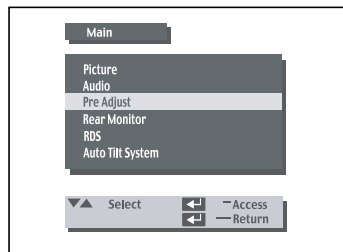

- Use ▲ ▼ Key and place cursor (Yellow Bar) on Pre Adjust and press ENTER key.
- Use ▲ ▼ Key and place cursor (Yellow Bar) on Color System and Press ENTER key as picture below.

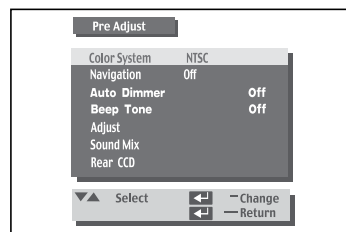

- Each time you press ENTER key, color system changes as below.

NTSC --> PAL --> SECAM --> NTSC

- * When no key is pressed for 5 seconds, the menu will disappear.

PRE ADJUST - (ADJUST TV SYSTEM)

- Press MENU key and select Pre Adjust until the monitor displays following picture.

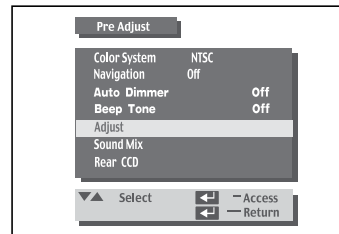

- Use ▲ ▼ Key and place cursor (Yellow Bar) on Adjust and press ENTER key.
- Use ▲ ▼ key and place cursor (Yellow bar) on TV and press ENTER key as picture below.

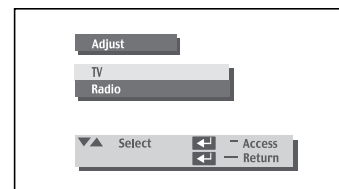

- Use ▲ ▼ key and place cursor (Yellow bar) on Field and Press ENTER key as picture below.

BASIC OPERATION

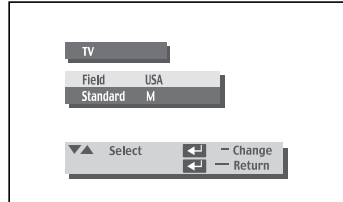

- Each time you press ENTER key, Field/Standard should be changed at the same time as below.

U.S.A/M-->CCIR1/BG-->CCIR2/BG --> Ireland/II'-->Australia/BG-->China/BG -->O.I.R.T/DK-->France/BG

* When no key is pressed for 5 seconds, the menu will disappear.

- Press ENTER key at least for 2 seconds on current screen to return to the previous screen. Press Menu key about 1 second to turn MENU off directly.

PRE ADJUST - (ADJUST RADIO SYSTEM)

- Press MENU key and select Pre Adjust until the monitor displays following picture.

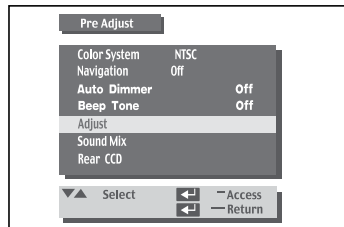

- Use ▲ ▼ Key and place cursor (Yellow Bar) on Adjust and press ENTER key.
- Use ▲ ▼ key and place cursor (Yellow bar) on Radio and press ENTER key as picture below.

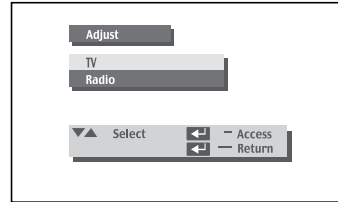

- Use ▲ ▼ key and place cursor (Yellow bar) on Band and press ENTER key as picture below.

- Each time you press ENTER key, Band changes as below.

U.S.A/100KHz--> Europe/50KHz--> O.I.R.T/50KHz-->Asia/50KHz--> Australia/100KHz -->

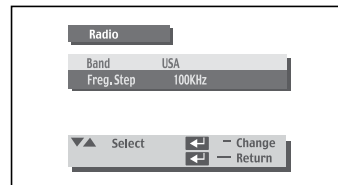

S.America/100KHz--> China/50KHz--> Japan/100KHz --> Korea/100KHz

* When no key is pressed for 5 seconds, the menu will disappear.

- Press ENTER key at least for 2 seconds on current screen to return to the previous screen. Press Menu key about 1 second to turn MENU off directly

PRE ADJUST - (ADJUST SOUND MIX)

- Press MENU key until the monitor displays following picture.

The monitor displays following picture.

BASIC OPERATION

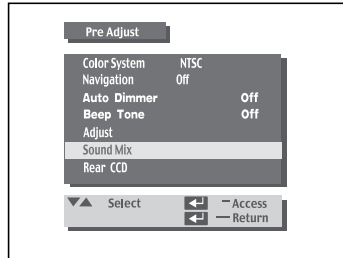

- Use ▲ ▼ Key and place cursor (Yellow Bar) on Sound Mix and press ENTER key.
- Use ▲ ▼ key and place cursor (Yellow bar) on Sub woofer and press ENTER key as picture below.

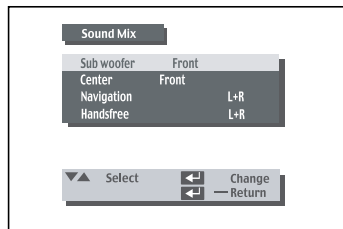

- Each time you press ENTER key, Sub Woofer changes as below.

FRONT --> REAR --> ALL --> OFF

- Press ENTER key at least for 2 seconds to return to the previous screen.
- Use ▲ ▼ key and place cursor (Yellow bar) on Center and press ENTER key as picture below.

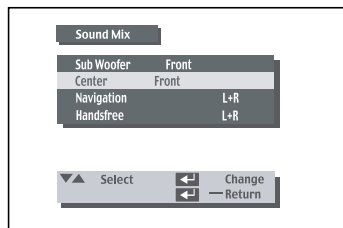

- Each time you press ENTER key, Center changes as below

FRONT --> REAR --> ALL --> OFF

- Press ENTER key at least for 2 seconds to return to the previous screen.
- Use ▲ ▼ key and place cursor (Yellow bar) on Navigation and press ENTER key as picture below.

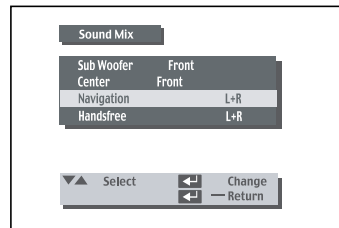

- Each time you press ENTER key, Navigation changes as below.

R --> L --> L+R --> OFF

- Press ENTER key at least for 2 seconds to return to the previous screen.

- Use ▲ ▼ key and place cursor (Yellow bar) on Hands free and press ENTER key as picture below.

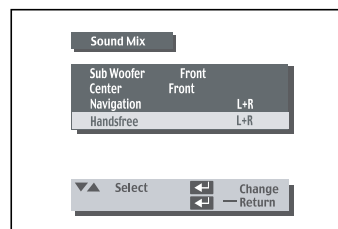

- Each time you press ENTER key, Hands free changes as below.

R --> L --> L+R --> OFF

BASIC OPERATION

- Press ENTER key at least 2 seconds on current screen to return to the previous screen. Press Menu key about 1 second to turn MENU off directly.

* When no key is pressed for 5 seconds, the menu will disappear.

PRE ADJUST - (ADJUST REAR CCD-FOR REAR VIEW CAMERA)

- Press MENU key and select Pre Adjust until the monitor displays following picture.

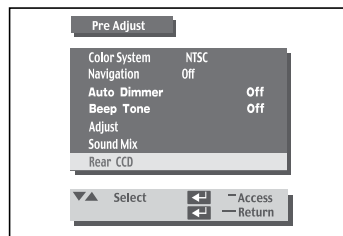

- Use ▲ ▼ Key and place cursor (Yellow Bar) on Rear CCD and press ENTER key.
- Use ▲ ▼ key and place cursor (Yellow bar) on Use and press ENTER key as picture below.

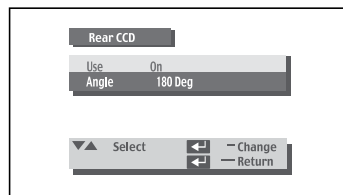

- Each time you press ENTER key, Use changes as below.

ON --> OFF

* When no key is pressed for 5 seconds, the menu will disappear.

- Press ENTER key at least for 2 seconds to return to the previous screen.
- Use ▲ ▼ key and place cursor (Yellow bar) on Angle and press ENTER key as picture below.

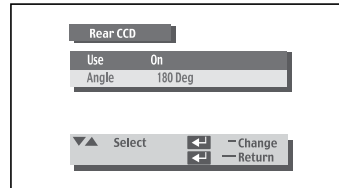

- Each time you press ENTER key, Angle changes as below.

0 deg --> 180 deg

- Press ENTER key at least for 2 seconds on current screen to return to the previous screen. Press Menu key about 1 second to turn MENU off directly.

REAR MONITOR

- Press MENU key until the monitor displays following picture.

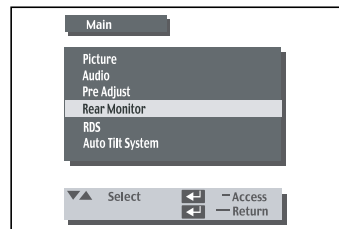

- Use ▲▼ Key and place cursor (Yellow Bar) on Rear Monitor and press ENTER key.

- Use ▲▼ key to set Rear Monitor as DVD or Radio or TV or AV1 or AV2 or Off as picture below.

BASIC OPERATION

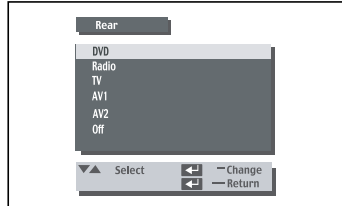

- * When no key is pressed for 5 seconds, the menu will disappear.

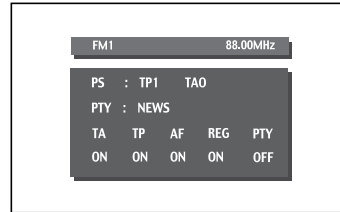

RDS (Radio Data System)

1. Press MENU key until the monitor displays following picture.

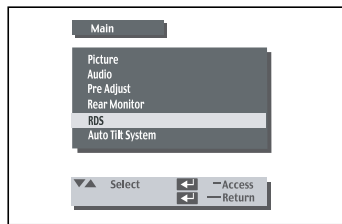

2. Use ▲ ▼ Key and place cursor (Yellow Bar) on RDS and press ENTER key.
3. Use ▲ ▼ Key and place cursor (Yellow) on On and press ENTER key as picture below.

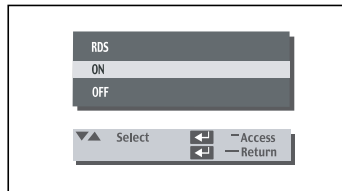

- * When no key is pressed for 5 seconds, the menu will disappear. Press ENTER key at least for 2 seconds on current screen to return to the previous screen. Press Menu key about 1 second to turn MENU off directly.

4. Press PS/BSM button to receive RDS stations as picture below.

AUTO TILT SYSTEM

1. Press MENU key until the monitor displays following picture.

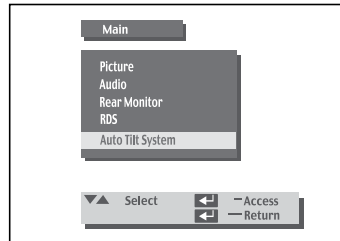

2. Use ▲ ▼ Key and place cursor (Yellow Bar) on Auto Tilt System and press ENTER key.
3. Use ▲ ▼ key to set Auto Tilt System as On or Off as picture below.

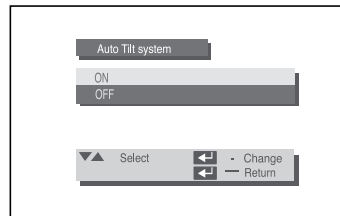

- * When no key is pressed for 5 seconds, the menu will disappear.

BASIC OPERATION

TUNING (TV-AUTO SEARCH)

1. After adjust TV system(Field/Standard) on Pre-Adjust, Press P.S/BSM to search TV channels.

* 'Searching' will be blinking as it searches TV channels and channel number is changing as it searches TV channels.

2. When Auto-Search is completed, memorized channels will be shown on the screen and cursor will be placed on the first channel as below. The next channels will be shown on the next screen by pressing BAND button.

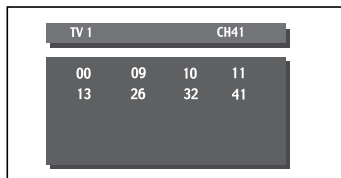

TV 1	CH41
00	09
10	11
13	26
32	41

TUNING (RADIO-AUTO SEARCH)

1. After adjust Radio system (Band/Freq. Step) on Pre-Adjust, press P.S/BSM to search RADIO channels.

* 'Searching' will be blinking as it searches Radio channels and channel number is changing as it searches RADIO channels.

2. When Auto-Search is completed, memorized channels will be shown on the screen and cursor will be placed on the first channel as below. The next channels will be shown on the next screen by pressing BAND button.

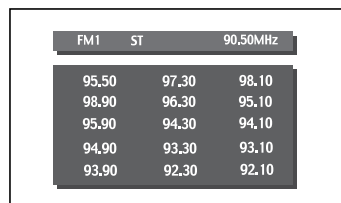

FM1	ST	90.50MHz
95.50	97.30	98.10
98.90	96.30	95.10
95.90	94.30	94.10
94.90	93.30	93.10
93.90	92.30	92.10

OVERVIEW OF THE RDS FUNCTION

AF (Alternative Frequencies) / REG (Regional)

When pressed short, AF switching mode is selected and the state of AF switching mode is displayed by AF segment in LCD.

Segment off : AF switching mode off

Segment on : AF switching mode on : Has RDS information.

Segment flashing : AF switching mode is selected, but RDS information is not received yet.

When AF switching mode is selected, the radio checks the signal strength of the AF all the time. The interval of checking time of each AFs depends on the signal strength of current station, from a few minute for strong station to a few seconds for weak station.

Every time that new AF is stronger than current station, it switches over to that frequency in short time. Because the mute time of AF switching or checking time is very short, it is almost inaudible in case of normal program.

When pressed long, it is activated of regional mode on/off.

Regional mode on : AF switching or PI SEEK is implemented to the station which has all PI codes are the same as current station. REG of individual segment is turned on also together with displaying "REG ON" on numeric display for a few seconds.

BASIC OPERATION

Regional mode off : The regional code in the format of PI code is ignored when AF switching or PI SEEK is implemented.

REG of individual segment is turned off together with displaying "REG OFF" on numeric display for a few seconds.

When regional mode is off, the radio may switch from a national program station to a local variant of that program, or from a local station in an area to a local station in another area. So, customers can listen to a wrong program when switched station transmits wrong program. To avoid this unwanted situation, REG should be on, and then the radio will only switch to an AF that broadcasts exactly the same program.

TA (Traffic Announcement) / TP (Traffic Program)

When pressed short, it is engaging whether TA mode on or off.

When TA mode is on and a traffic announcement is transmitted :

- When the unit was in CD mode, it will switch temporarily to radio mode.
- If the volume level was under the threshold point it will be raised to the threshold point but the user changed the volume level which was more than the threshold point. (Min. TA volume level), it will be set to the last level.
- When TA mode is on, TA of individual segment is turned on.
- When a TP station is received, TP of individual segment is turned on.

* TA interruption function

The current traffic announcement is cancelled by pressing this key but the TA mode will not be off.

PTY (Program Type)

This key is operated as follows.

- PTY MUSIC group ---> PTY SPEECH group ---> PTY off.

While selecting PTY engagement, its selection is implemented by preset buttons as described in preset key. When PTY is selected, the radio starts to search corresponding PTY information, and stops if the corresponding PTY information is detected.

If corresponding PTY information is not existed any more, PTY engaging is automatically exit to normal mode.

DVD VIDEO PLAYER OPERATION

1. CHANGING DVD SYSTEM SETTING

Press SET UP button and then, there should be shown 5 categories as Language, Video, Audio, More Audio and Parental.

1) Language

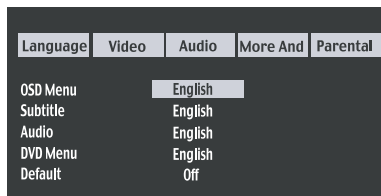

As shown above, Language for OSD can be changed to English, French, Japanese, Korean and Spanish.

2) Video

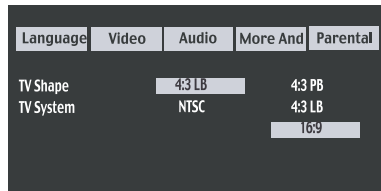

In this video mode, TV Shape & TV System can be changed.

3) Audio

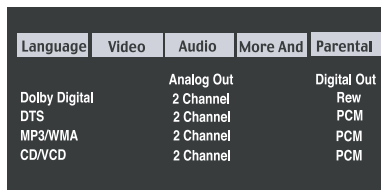

There are two outputs as analog and digital output and analog output can be changed to 2 CH (4CH output) and 6 CH (5.1CH). And its digital output is only for additional decoder processor.

※ About 2CH or 6CH Setup:

If 2CH is set into this menu with Analog out, it's sound will come out by 2CH even though DVD title was set by 5.1CH Sound. To enjoy Dolby Digital or DTS Sound with Analog out, this menu must be set by 6CH with Dolby Digital and DTS Category and DVD title also has to set up by 5.1CH.

4) More Audio

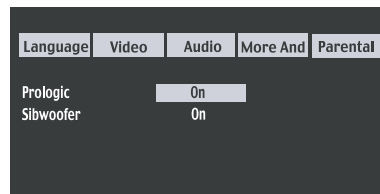

Dolby Prologic and Subwoofer can be on/off in this mode.

5) Parental

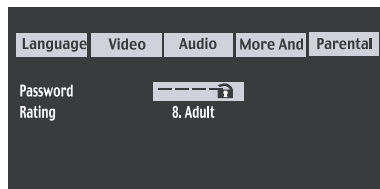

This is to prohibit the playing of specified DVDs which are unsuitable for children. Some discs contain a restriction level which enables parents to remove scenes or prevent playback of discs by children. DVD players are equipped with a password designed to prevent children changing the level.

2. BASIC PLAYBACK

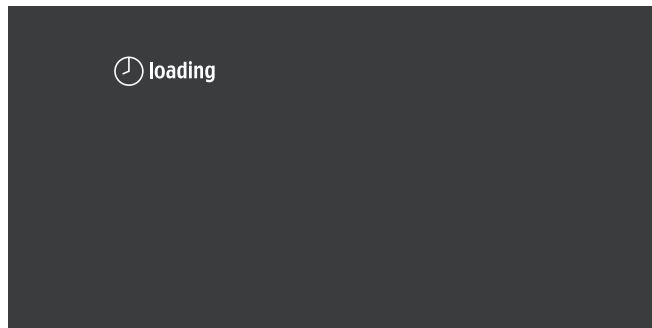

Preparation

Insert a disc into the center of the insertion slot with the label side faced up. The disc plays automatically after loading.

Note:

- Never insert foreign objects into the disc insertion slot.
- If the disc is not inserted easily, there may be an other disc in the mechanism or the unit may require service.

Loading 8cm discs

- No adapter is required to play an 8cm disc.
- Insert the 8cm disc into the center of the insertion slot.

DVD VIDEO PLAYER OPERATION

1) POWER/MODE

Use this button to turn on/off. For Turn - off, hold this button about 2 seconds or longer. Each time This button is pressed, its source should be changed to AV1 → AV2 → DVD → RADIO → TV.

2) OPEN/CLOSE

Use this button to open/close the TFT LCD Panel.

3) EJECT

Use this button to eject a disc in slot for 2 seconds or longer.

4) PLAY/PAUSE

The disc will be loaded and playback will automatically and if it is pressed once more during playback, it will be worked by pause.

- If a single-sided disc is loaded upside down, it will come out automatically in a few seconds.
- If an Audio CD is loaded, the “CD” indicator appears on LCD. If an MP3 CD is loaded, the “MP3” indicator appears on LCD. If you want to change folder, press TITLE key for 2 seconds or longer and then select the folder you want.
- When all chapters on the disc have played, this unit will automatically stop. If several titles are on the disc, the disc’s menu screen will reappear.

※ How to use Remocon

To choose any function inside a circle press Key for 1 Second and to choose one outside a circle for at least 2 Seconds.

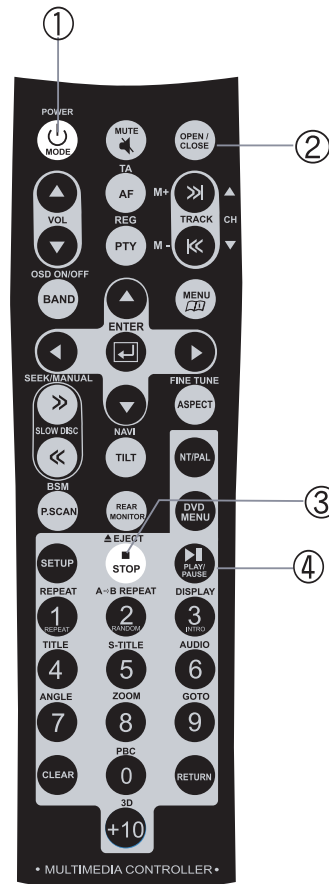

DVD VIDEO PLAYER OPERATION

5) CHANGING SUBTITLE LANGUAGE (S-TITLE)

It is possible to change the subtitle language to a different language from the selected one. This operation works only with discs on which multiple subtitle languages are recorded.

- Press S-TITLE button for 3 seconds or longer during playback.
- Press repeatedly S-TITLE until the desired language is selected.
- To eliminate the On Screen Subtitle, please press S-TITLE repeatedly to select OFF.

6) CHANGING AUDIO SOUND TRACK LANGUAGE (AUDIO)

It is possible to change the Audio Soundtrack Language to a different language from the selected one at the initial setting. This operation works only with discs on which multiple audio sounds are recorded.

- Press AUDIO button for 3 seconds or longer during playback.
- Desired Audio Soundtrack Language is selected.

7) DISPLAY

When pressing Display button for 2 seconds or longer, there shows PlayTime status and if press it one more for 2 seconds or longer there shows all information for title like below. In CD Changer Mode, this button should be operated by Intro Scan that each track playback for 5 seconds.

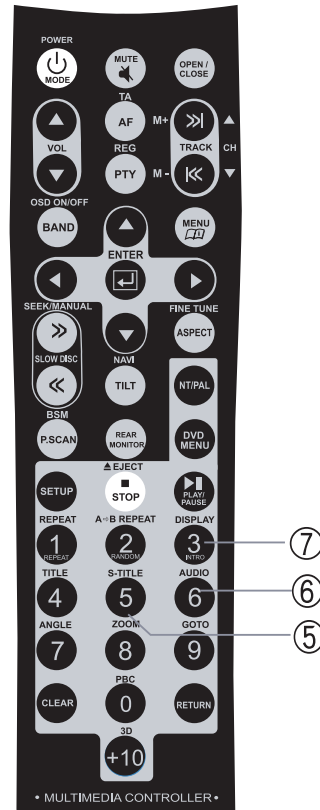

DVD VIDEO PLAYER OPERATION

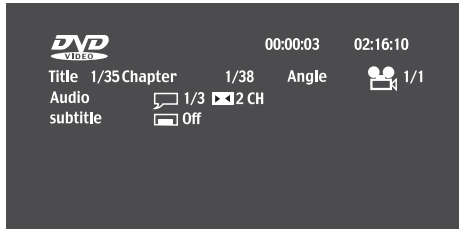

Playback of the selected item will begin.

8) REPEAT (SET UP)

To repeat viewing or listening, press REPEAT during playback. Each time this button is pressed, the TV Screen changes as below.

Repeat Chapter → Repeat Title → Shuffle
 → Off.(DVD Title) / Repeat One → Shuffle
 → Off.(Audio CD Title)

9) A-B REPEAT

Repeating sections between two specific points (A-B repeat).

- Press A-B during playback at the point where repeat play is to start(A).
- Press A-B during playback at the point where repeat play is to be concluded(B).
- Repeat play of the selected section(A-B) starts.
- To return to normal play, press A-B once, and then "OFF" will appear. In CD Changer Mode, this button should be worked by Random playback.

10) DIRECTION BUTTONS - MENU/TITLE NAVIGATION & MOVEMENT

Press ▲/▼/▶/◀ and press ENTER, or press the numeric button(s), to select the desired item.

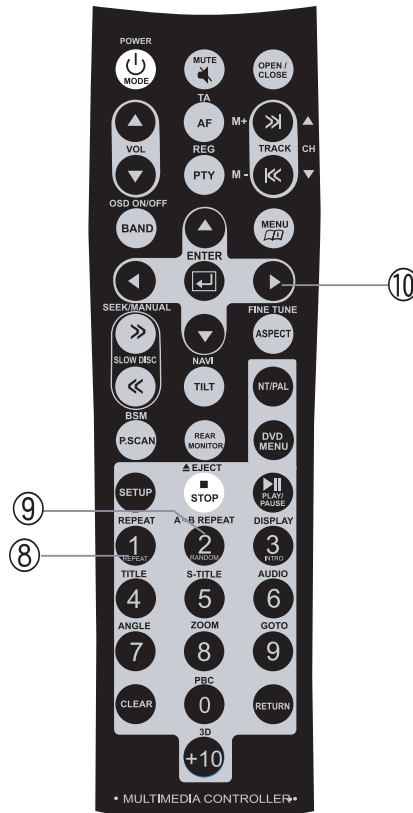
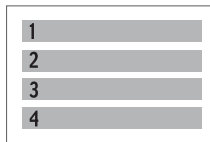

DVD VIDEO PLAYER OPERATION

For further information, also refer to any instructions that may have been packaged with the disc you are playing.

After playback

When the unit is not in use, remove the disc and turn off the power by pressing the POWER button.

(Do not remove the disc if you plan to use the “LAST MEMORY” function explained on the next page).

NOTES

- If “⊘” appears on the screen when a button is pressed, it means that the selected function is not available on the disc you are playing at that time.
- Depending on the specific DVD disc, some operations may be different or restricted. For this refer to the jacket or case of the disc you are playing.



DVD VIDEO PLAYER OPERATION

3. LAST MEMORY - PICKING UP WHERE YOU LEFT OFF & OTHERS

This unit is equipped with a “LAST MEMORY” function which lets you resume viewing of a movie from the point where you left off. You must press only PLAY button, not Power button in case the power has been turned off (and stand by power)

NOTE

The Last Memory function is not supported once the disc is removed from the slot.

1) VOLUME UP/ DOWN

Adjust the Volume by pressing the VOLUME +/- buttons.

2) GOTO SEARCH

Press the GOTO button to move to any title chapter or elapsed time on the disc.

- Time: Input the desired elapsed time with the Numeric Keypad, then press the ENTER button.
- TITLE/CHAPTER: Input the desired title or Chapter # with the Numeric Keypad, then press the ENTER button.

3) ZOOM

Press the ZOOM button to “Zoom-in” (enlarging the picture on the screen). Press the ZOOM button repeatedly to cycle Zoom between < 1 < 2 < 3 < Off.

While in Zoom mode, the Direction buttons allow you to view areas of the picture that are not visible on the screen.



DVD VIDEO PLAYER OPERATION

4) ANGLE

Some DVDs may contain scenes which have been shot simultaneously from number of different angles. For these discs, the same scene can be viewed from each of these different angles using the ANGLE button. (The recorded angles differ depending on the disc used.)

5) SLOW DISC

Press and hold this button during playback. Every time this button is pressed shortly, its speed should be changed by x2, x4, x8, x20 with fast forward and fast backward. And if it is pressed about 2 seconds and longer, its picture will be moved by one frame.

6) DVD MENU

Press this button to show the menu of DVD Title and choose one of menus as desired.

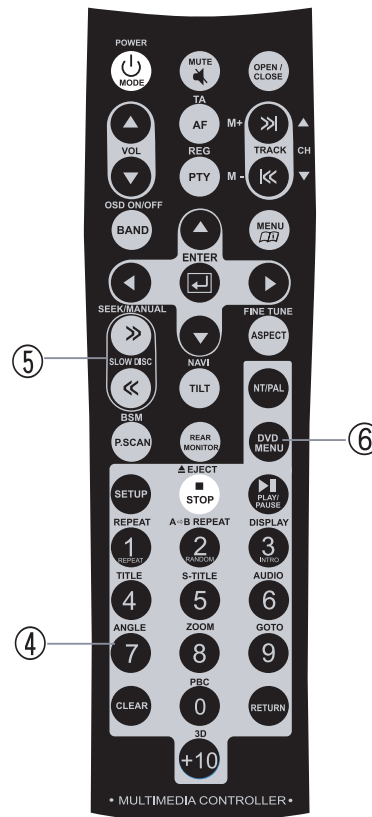

AM/FM RADIO OPERATION

1. BAND (AM/FM)

Each time this button is pressed, the band will be changed to FM1 → FM2 → FM3 → AM1 → AM2

2. PRESET SCAN/BSM

Following your desired band selection, press P.S/BSM button about 2 seconds or longer, and then tuner will search until stations of sufficient strength have been found and will store them in sequence. The stored each station will playback for 5 seconds in sequence until you select one stored channel by pressing P.S/BSM one more.

3. MANUAL (SEEK) UP/DOWN

To find out a desired station, press this button until 'beep' sound is heard and then, press it shortly in no time moving to the very station step by step.

*After above process, at least 3 seconds is necessary to perform below process.

If you press it shortly, tuner will seek and playback a next station.

4. TRACK (P.SEEK/CH) UP/DOWN

Press this button to move to the stored next station you want. In Disc mode, this button is worked by Track Up/Down.

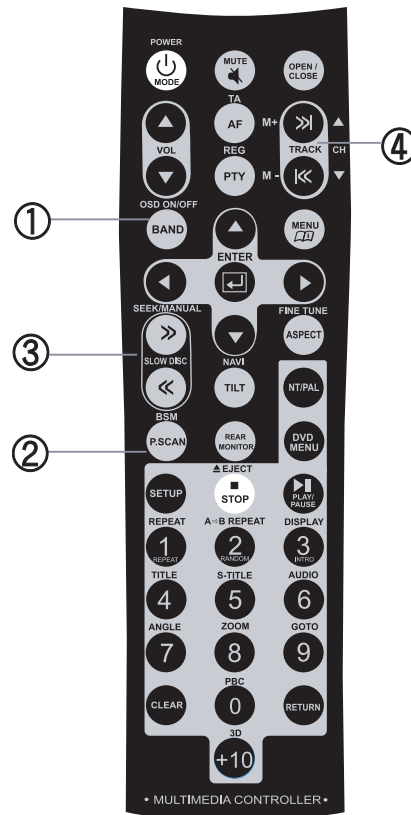

INSTALLATION

PRECAUTIONS

Choose the mounting location carefully so that the unit will not interfere with the normal driving functions of the driver. Avoid installing the unit where it would be subject to high temperatures, such as from direct sunlight or hot air from the heater or where it would be subject to dust, dirt or excessive vibration. Use only the supplied mounting hardware for a safe and secure installation.

MOUNTING ANGLE ADJUSTMENT

Adjust the mounting angle to less than 20 °

MOUNTING EXAMPLE

Installation in the dashboard

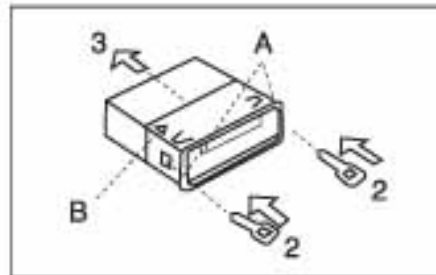
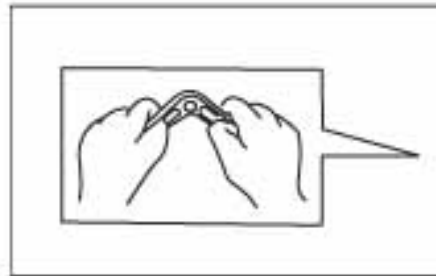
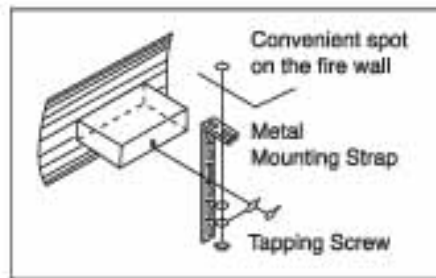

STRAP

Be sure to use the strap to secure the back of the unit in place. The strap can be bent by hand to the desired angle.

HOLDER

After inserting the holder into the dashboard, select the appropriate tabs according to the thickness of the dashboard material and bend them inwards to secure the holder in place.

HOW TO DETACH THE MOUNTING FRAME

1. Insert release keys into the slots A.
2. Remove the frame B from the unit.

NOTE.

Keep the release keys in the safe place, as you may need it in the future to remove the unit from the car.



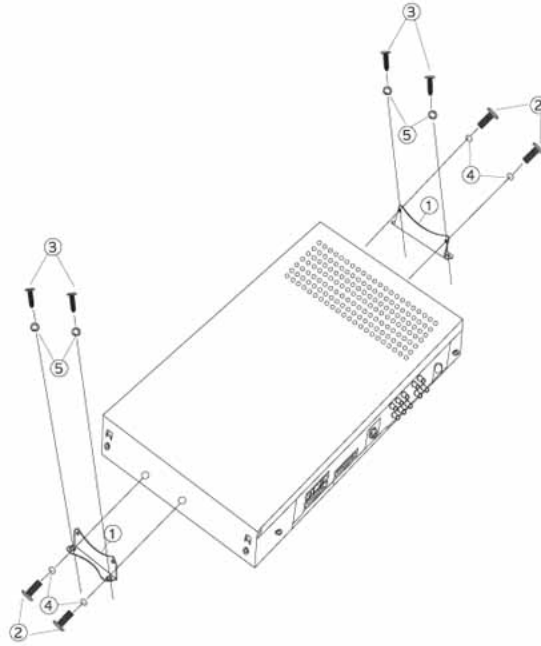

INSTALLATION

Make sure that the unit is installed securely in place. If the unit is unstable, it may malfunction. For example, the source may skip.

1. Align the holes in the unit with the vehicle mounting bracket and secure the unit with the accessory screws.
2. During installation, do not use any screw except for these provided. The use of different screws might result in damage to the main unit.
Damage may occur if a screwdriver or similar tool is used with excessive force during the installations.



SUPPLIED MOUNTING KIT

① BRACKET X2 	② MACHINE SCREW (M4 X 6) X4 	③ MACHINE SCREW (M5 X 6) X4 	④ FALT WASHER (∅ 5 X 0.5T) X 4 
			⑤ FALT WASHER (∅ 5 X 0.5T) X 4 

SPECIFICATIONS

FM TUNER

Frequency Range: 87.50 MHz to 108.0 MHz
 Usable Sensitivity: 9 dBf
 50dB Quieting Sensitivity: 15 dBf
 Alternate Channel Selectivity: 70 dB
 Stereo Separation (1 kHz): 30 dB
 Frequency Response (+/-3 dB): 30Hz to 15 kHz

AM TUNER

Frequency Range: 530kHz to 1710kHz
 Usable Sensitivity: 25 dBuV

TV TUNER

Receiving Channel: VHF LOW (S3-NZ1)
 VHF HIGH (E12-E5)
 UHF (E69-E21)

DVD PLAYER

System : Digital Versatile Disc System with CDDA capable
 Usable discs : DVD video disc, Compact Disc
 Frequency Response:
 20Hz to 20 kHz (± 3 dB)
 20Hz to 20 kHz (CD) (± 3 dB)
 Signal to Noise Ratio: 90 dB (1kHz) IHF-A
 Dynamic Range: 90 dB (1 kHz)
 Distortion: 0.05%

AUDIO AMPLIFIER

Rated power output:
 18W \times 4 (20 Hz to 20 kHz, 1%, 4 Ω)
 Maximum power output: 200W (50W \times 4)
 Speaker impedance: 4 Ω (4 to 8 Ω)

INPUT

Audio input:
 780 \pm 50mVrms
 (input impedance 10k Ω or greater)
 Video input:
 1.0 \pm 0.2 Vp-p (input impedance 75 Ω)

VIDEO OUTPUT

Video output:
 1.0 \pm 0.2Vp-p (output impedance 75 Ω)

LCD MONITOR

Screen Size : 7-inch wide type
 166mm Width \times 100mm Height
 Display method:
 Transmission type TN liquid crystal display
 Drive method: TFT (thin-film transistor)
 active matrix driving
 Pixels: 336,960 (1440 \times 234)

GENERAL

Power source voltage:
 14.4VDC(10.8 to 15.6V allowable)
 Ground: Negative
 Current consumption: 3.0A (1W)
 Auto Antenna Rated Current: 500 mA less
 Dimensions of the Main Unit:
 178mm Width \times 50mm Height \times 159.8mm Depth
 Dimensions of the Tuner Amp Unit:
 166mm Width \times 38mm Height \times 266mm Depth
 Weight of the Main Unit: 2kg
 Weight of the Tuner Amp Unit: 1kg
 Dimensions of the Remote Control Unit:
 50.8mm Width \times 11.4mm Height \times 160mm Depth
 Weight of the Remote Control Unit: 70g

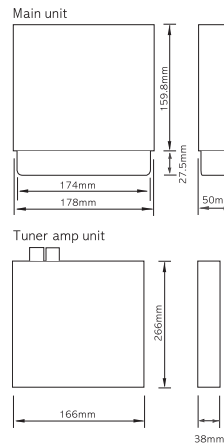

NOTES

Specifications and design are subject to change without notice for further improvement.

WARNING

DO NOT HOLD THE LCD SCREEN PANEL WHILE IT IS OPENING OR CLOSING UNTIL IT IS COMPLETELY OPENED OR CLOSED. OTHERWISE, THE MOTORIZED MECHANISM WILL BE DAMAGED.

BEFORE WORKING THE UNIT, READ THE OWNER'S MANUAL CAREFULLY AND FOLLOW UP THE INSTRUCTIONS IN IT. ALWAYS WORK THE UNIT WITH THE REMOTE CONTROLLER OR THE FUNCTION BUTTONS ON THE UNIT. OTHERWISE, THE UNIT CAN BE DAMAGED.