

VocoPro[®]

THE SINGER'S ULTIMATE CHOICE[™]

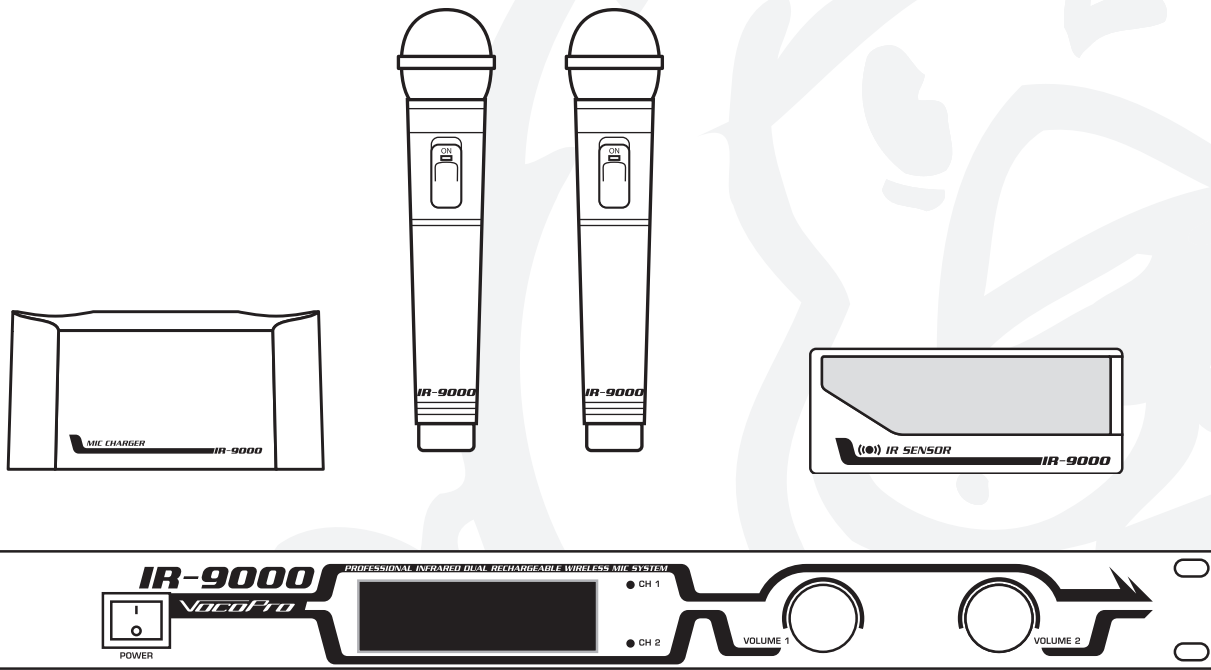

IR-9000

Professional Infrared Dual Rechargeable
Wireless Mic System

o w n e r ' s m a n u a l

Table of Contents

Listening for a Lifetime	3
Safety Instructions	4
FCC Information	5
Welcome	6
Getting Started	7
Getting Connected	8
Operations	11
Descriptions and Functions	12
Troubleshooting	14
Technical Specs	15

Listening for a lifetime

Selecting fine audio equipment such as the unit you've just purchased is only the start of your musical enjoyment. Now it's time to consider how you can maximize the fun and excitement your equipment offers. VocoPro and the Electronic Industries Association's Consumer Electronics Group want you to get the most out of your equipment by playing it at a safe level. One that lets the sound come through loud and clear without annoying blaring or distortion and, most importantly, without affecting your sensitive hearing.

Sound can be deceiving. Over time your hearing "comfort level" adapts to a higher volume of sound. So what sounds "normal" can actually be loud and harmful to your hearing. Guard against this by setting your equipment at a safe level BEFORE your hearing adapts.

To establish a safe level:

- Start your volume control at a low setting.
- Slowly increase the sound until you can hear it comfortably and clearly, and without distortion.

Once you have established a comfortable sound level:

- Set the dial and leave it there.
- Pay attention to the different levels in various recordings.

Taking a minute to do this now will help to prevent hearing damage or loss in the future. After all, we want you listening for a lifetime.

Used wisely, your new sound equipment will provide a lifetime of fun and enjoyment. Since hearing damage from loud noise is often undetectable until it is too late, this manufacturer and the Electronic Industries Association's Consumer Electronics Group recommend you avoid prolonged exposure to excessive noise. This list of sound levels is included for your protection.

Some common decibel ranges:

Level	Example
30	Quiet library, Soft whispers
40	Living room, Refrigerator, Bedroom away from traffic
50	Light traffic, Normal Conversation
60	Air Conditioner at 20 ft., Sewing machine
70	Vacuum cleaner, Hair dryer, Noisy Restaurant
80	Average city traffic, Garbage disposals, Alarm clock at 2 ft.

The following noises can be dangerous under constant exposure:

Level	Example
90	Subway, Motorcycle, Truck traffic, Lawn Mower
100	Garbage truck, Chainsaw, Pneumatics drill
120	Rock band concert in front of speakers
140	Gunshot blast, Jet plane
180	Rocket launching pad

-Information courtesy of the Deafness Research Foundation

Safety instructions

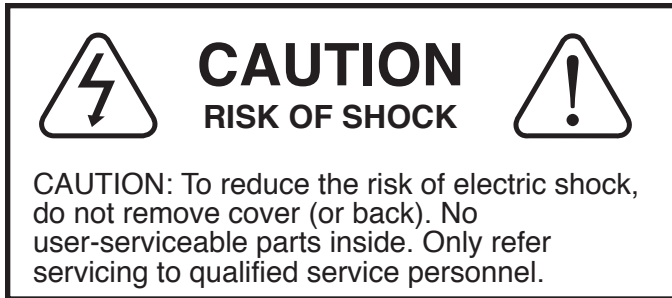

Explanation of Graphical Symbols



The lightning flash & arrowhead symbol, within an equilateral triangle, is intended to alert you to the presence of danger.



The exclamation point within an equilateral triangle is intended to alert you to the presence of important operating and servicing instructions.

WARNING

To reduce the risk of fire or electric shock, do not expose this unit to rain or moisture.

1. Read Instructions - All the safety and operating instructions should be read before the appliance is operated.

2. Retain Instructions - The safety and operating instructions should be retained for future reference.

3. Heed Warnings - All warnings on the appliance and in the operating instructions should be adhered to.

4. Follow Instructions - All operating and use instructions should be followed.

5. Attachments - Do not use attachments not recommended by the product manufacturer as they may cause hazards.

6. Water and Moisture - Do not use this unit near water. For example, near a bathtub or in a wet basement and the like.

7. Carts and Stands - The appliance should be used only with a cart or stand that is recommended by the manufacturer.

7 A. An appliance and cart combination should be moved with care. Quick stops, excessive force, and uneven surfaces may cause an overturn.



8. Ventilation - The appliance should be situated so its location does not interfere with its proper ventilation. For example, the appliance should not be situated on a bed, sofa, rug, or similar surface that may block the ventilation slots.

9. Heat - The appliance should be situated away from heat sources such as radiators, heat registers, stoves, or other appliances (including amplifiers) that produce heat.

10. Power Sources - The appliance should be connected to a power supply only of the type described in the operating instructions or as marked on the appliance.

11. Grounding or Polarization - Precautions should be taken so that the grounding or polarization means of an appliance is not defeated.

12. Power-Cord Protection - Power-supply cords should be routed so that they are not likely to be walked on or pinched by items placed upon or against them, paying particular attention to cords at plugs, convenience receptacles, and the point where they exit from the appliance.

13. Cleaning - Unplug this unit from the wall outlet before cleaning. Do not use liquid cleaners or aerosol cleaners. Use a damp cloth for cleaning.

14. Power lines - An outdoor antenna should be located away from power lines.

15. Nonuse Periods - The power cord of the appliance should be unplugged from the outlet when left unused for a long period of time.

16. Object and Liquid Entry - Care should be taken so that objects do not fall and liquids are not spilled into the enclosure through openings.

17. Damage Requiring Service - The appliance should be serviced by qualified service personnel when:

- A. The power supply cord or plug has been damaged; or
- B. Objects have fallen into the appliance; or
- C. The appliance has been exposed to rain; or
- D. The appliance does not appear to operate normally or exhibits a marked change in performance; or
- E. The appliance has been dropped, or the enclosure damaged.

18. Servicing - The user should not attempt to service the appliance beyond that described in the operating instructions. All other servicing should be referred to qualified service personnel.

Note:

To CATV system installer's (U.S.A.): This reminder is provided to call the CATV system installer's attention to Article 820-40 of the NEC that provides guidelines for proper grounding and, in particular, specifies that the cable ground shall be connected as close to the point of cable entry as practical.

FCC information (U.S.A.)

1. IMPORTANT NOTICE: DO NOT MODIFY THIS

UNIT!: This product, when installed as indicated in the instructions contained in this manual, meets FCC requirements. Modifications not expressly approved by Vocopro may void your authority, granted by the FCC, to use this product.

2. IMPORTANT: When connecting this product to accessories and/or another product use only high quality shielded cables. Cable(s) supplied with this product **MUST** be used. Follow all installation instructions. Failure to follow instructions could void your FCC authorization to use this product in the U.S.A.

3. NOTE: This product has been tested and found to comply with the requirements listed in FCC Regulations, Part 15 for Class "B" digital devices. Compliance with these requirements provides a reasonable level of assurances that your use of this product in a residential environment will not result in harmful interference with other electronic devices. This equipment generates/uses radio frequencies and, if not installed and used according to the instructions found in the owner's manual, may cause interference harmful to the operation of other electronic devices. Compliance with FCC regulations does not guarantee that interference will not occur in all installations. If this product is found to be the source of interference, which can be determined by turning the unit "Off" and "On", please try to eliminate the problem by using one of the following measures:

Relocate either this product or the device that is being affected by the interference.

Use power outlets that are on different branch (circuit breaker or fuse) circuits or install AC line filter(s).

In the case of radio or TV interference, relocate/reorient the antenna. If the antenna lead-in is 300-ohm ribbon lead, change the lead-in to coaxial type cable.

If these corrective measures do not produce satisfactory results, please contact your local retailer authorized to distribute Vocopro products. If you can not locate the appropriate retailer, please contact Vocopro, 1728 Curtiss Court, La Verne, CA 91750.

CAUTION

The apparatus is not disconnected from the AC power source so long as it is connected to the wall outlet, even if the apparatus itself is turned off. To fully insure that the apparatus is indeed fully void of residual power, leave unit disconnected from the AC outlet for at least fifteen seconds.

CAUTION:

READ THIS BEFORE OPERATING YOUR UNIT

1. To ensure the finest performance, please read this manual carefully. Keep it in a safe place for future reference.

2. Install your unit in a cool, dry, clean place - away from windows, heat sources, and too much vibration, dust, moisture or cold. Avoid sources of hum (transformers, v motors). To prevent fire or electrical shock, do not expose to rain and water.

3. Do not operate the unit upside-down.

4. Never open the cabinet. If a foreign object drops into the set, contact your dealer.

5. Place the unit in a location with adequate air circulation. Do not interfere with its proper ventilation; this will cause the internal temperature to rise and may result in a failure.

6. Do not use force on switches, knobs or cords. When moving the unit, first turn the unit off. Then gently disconnect the power plug and the cords connecting to other equipment. Never pull the cord itself.

7. Do not attempt to clean the unit with chemical solvents: this might damage the finish. Use a clean, dry cloth.

8. Be sure to read the "Troubleshooting" section on common operating errors before concluding that your unit is faulty.

9. This unit consumes a fair amount of power even when the power switch is turned off. We recommend that you unplug the power cord from the wall outlet if the unit is not going to be used for a long time. This will save electricity and help prevent fire hazards. To disconnect the cord, pull it out by grasping the plug. Never pull the cord itself.

10. To prevent lightning damage, pull out the power cord and remove the antenna cable during an electrical storm.

11. The general digital signals may interfere with other equipment such as tuners or receivers. Move the system farther away from such equipment if interference is observed.

NOTE:

Please check the copyright laws in your country before recording from records, compact discs, radio, etc. Recording of copyrighted material may infringe copyright laws.

Voltage Selector (General Model Only)

Be sure to position the voltage selector to match the voltage of your local power lines before installing the unit.

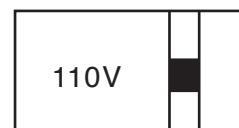

Welcome



And Thank you for purchasing the **IR-9000** from VocoPro, your ultimate choice in Karaoke entertainment! With years of experience in the music entertainment business, VocoPro is a leading manufacturer of Karaoke equipment, and has been providing patrons of bars, churches, schools, clubs and individual consumers the opportunity to sound like a star with full-scale club models, in-home systems and mobile units. All our products offer solid performance and sound reliability, and to reinforce our commitment to customer satisfaction, we have customer service and technical support professionals ready to assist you with your needs. We have provided some contact information for you below.

VocoPro

1728 Curtiss Court
La Verne, CA 91750

Toll Free: 800-678-5348

TEL: 909-593-8893

FAX: 909-593-8890

VocoPro Company Email Directory

Customer Service & General Information

info@vocopro.com

Tech Support

techsupport@vocopro.com

Remember Our Website

Be sure to visit the VocoPro website **www.vocopro.com** for the latest information on new products, packages and promos. And while you're there don't forget to check out our Club VocoPro for Karaoke news and events, chat rooms, club directories and even a KJ Service directory!

We look forward to hearing you sound like a PRO, with VocoPro, your ultimate choice in Karaoke entertainment.

FOR YOUR RECORDS

Please record the model number and serial number below, for easy reference, in case of loss or theft. These numbers are located on the rear panel of the unit. Space is also provided for other relevant information

Model Number _____

Serial Number _____

Date of Purchase _____

Place of Purchase _____

Getting Started

When unpacking your IR-9000 we recommend that you keep the original receipt or invoice, box and packing materials in case the product ever needs to be shipped for warranty repair or any other purpose.

Warranty Information

The IR-9000 is covered under a 1-Year Limited Warranty. For detailed warranty information please visit www.vocopro.com/warranty_standard.html

Extended Limited Warranty

Extended Warranties are also available and can be purchased directly from VocoPro. Visit www.vocopro.com/warranty_extended.html for information and purchasing of our Silver and Gold Extended Limited Warranties.

Service Centers

For a list of U.S. and International Authorized VocoPro Service Centers visit www.vocopro.com/frm_service.html

Package Contents

Before using the IR-9000 make sure the following accessories are included:

- 1 IR-9000 Receiver Unit
- 2 Wireless Microphones
- 2 DC Power Adapters
- 1 1/4" Jack Patch Cable
- 1 Microphone Charge Cradle
- 1 IR Sensor
- 1 IR Sensor Connection Cable
- 1 Warranty Card

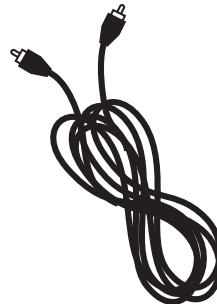
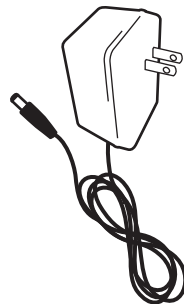
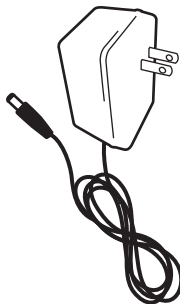
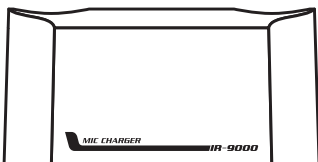
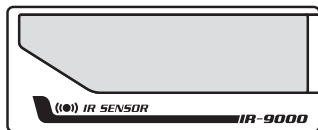
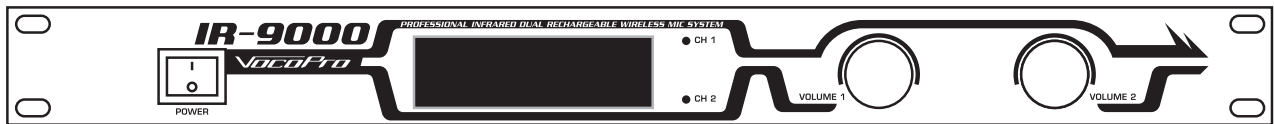
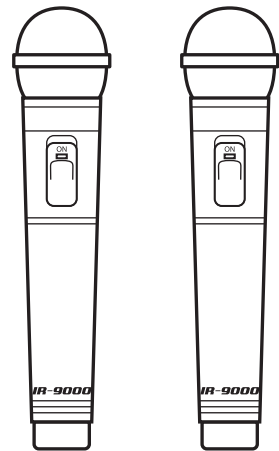

Getting Connected

Connecting the Power Supplies

The IR-9000 includes two power supplies, one for the receiver unit (AC 110V) and one for the microphone charger (AC 110V).

Surge Protector Recommended

VocoPro recommends that you use a surge protector with all of your products to prevent damage caused by unpredictable power surges. Damage to your unit caused by a power surge may void the warranty.

Connecting Power to the Receiver Unit (Fig. A)

NOTE: Make sure the receiver unit is turned off before connecting the power

Using the AC 110V - DC 15V 500mA power supply

1. Connect the AC end to a surge protector / power strip
2. Connect the other end to the DC input on the rear panel of the receiver unit

(Fig. A)

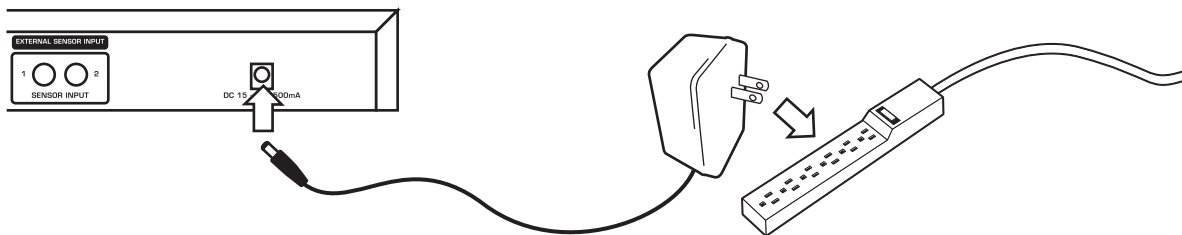

Connecting Power to the Microphone Charger (Fig. B)

Using the AC 110V - DC 9V 800mA power supply

1. Connect the AC end to a surge protector / power strip
2. Connect the other end to the DC input on the back of the microphone charger

(Fig. B)

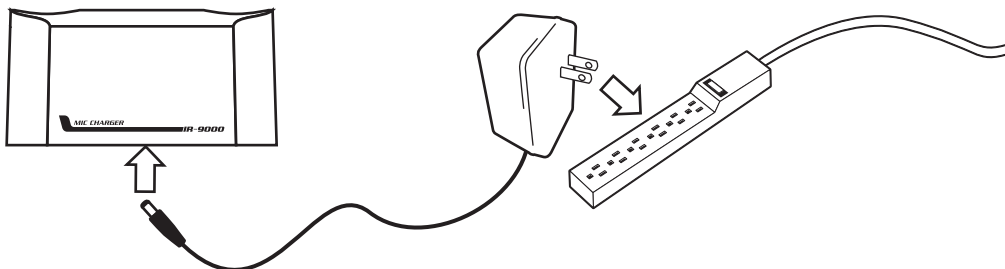

Getting Connected cont.

Connecting to a Mixer, amplifier or other audio input device

The IR-9000 allows you to either connect each microphone channel individually to separate channels using the CH.1 and CH.2 outputs (Fig. C) or both microphone channels together through the MIXED output (Fig. D).

Connecting Each Microphone Channel Individually (Fig. C)

What you will need:

- Two ¼" Microphone Cables
- A mixer, amplifier or other audio input device with two available ¼" microphone inputs

1. Connect one end of each ¼" microphone cable to the CH.1 and CH. 2 outputs on the rear panel of the receiver unit
2. Connect the other ends to the ¼" microphone input channels on a mixer, amplifier or other audio input device

Connecting Both Microphone Channels to One Input (Fig. D)

What you will need:

- One ¼" Microphone Cable
- A mixer, amplifier or other audio input device with one available ¼" microphone input

1. Connect one end of the ¼" microphone cable to the MIX ¼" output on the rear panel of the receiver unit
2. Connect the other end to the ¼" microphone input channel on a mixer, amplifier or other audio input device

(Fig. C)

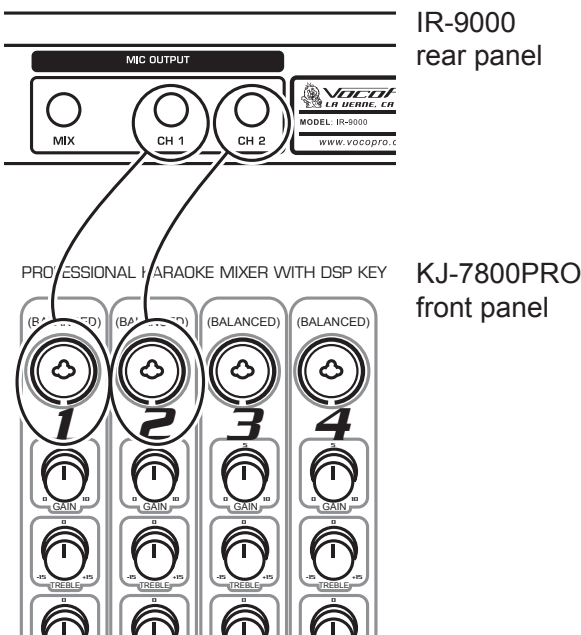

(Fig. D)

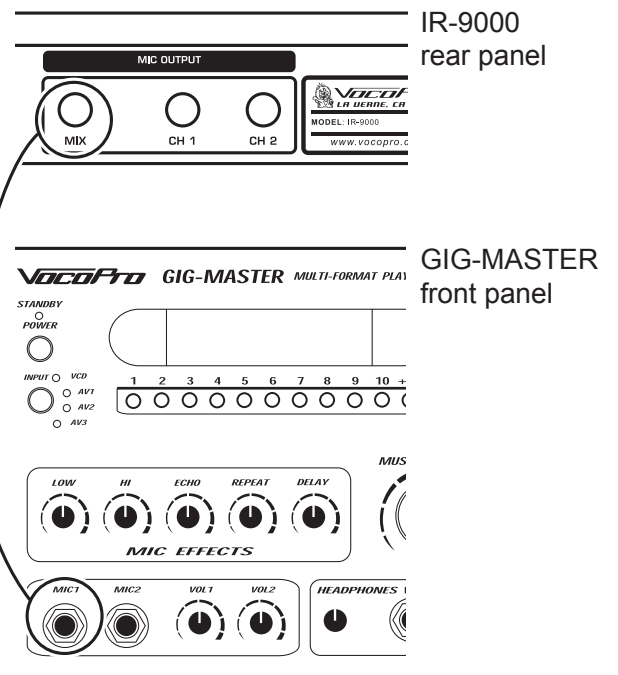

Getting Connected cont.

Connecting the External Infrared Sensor(s)

The IR-9000 can connect up to two external infrared sensors. One is included and a second one can be purchased from your nearest VocoPro dealer.

1. Connect The RCA end of the sensor to one of the External Sensor Inputs on the rear panel of the receiver unit
2. Position the sensor in a place where there are no barriers between it and the microphones

NOTE: Infrared signals cannot travel through walls or other dense objects, so make sure there is an open path between each microphone and the IR sensor(s).

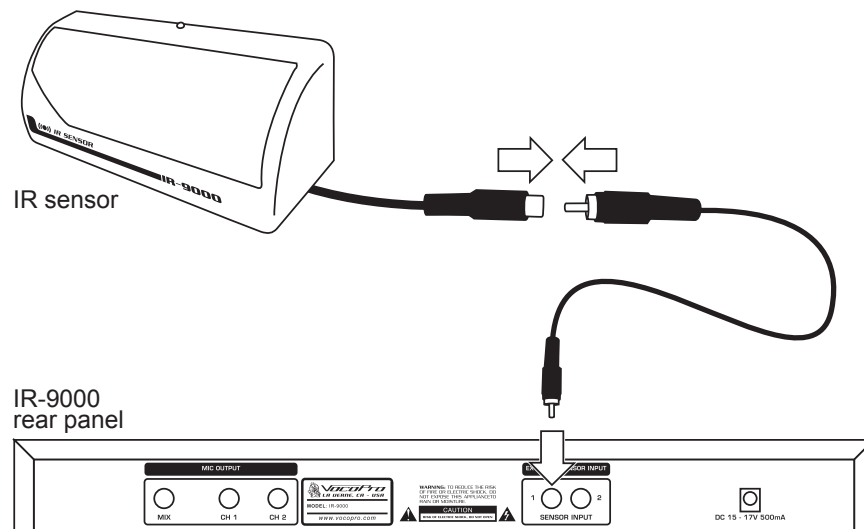

Operations

Turning on the IR-9000

Receiver Unit

Make sure all cables and power supplies are connected correctly and firmly.

1. Press the power switch ON to turn the power on
2. Press the power switch OFF to turn the power off

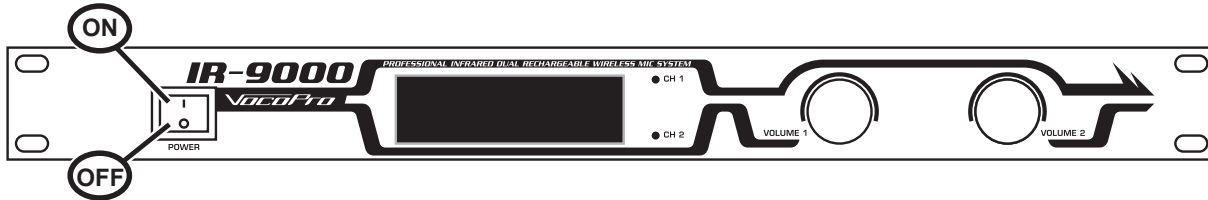

Microphones

1. Slide the power switch to the ON position to turn the power on
2. Slide the power switch to the OFF position to the power off

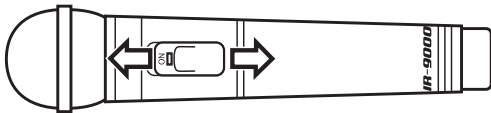

Adjusting the Volume

Both microphone channels have individual volume controls for precise vocal balancing. VOLUME 1 adjusts the volume for Mic Channel 1 and VOLUME 2 adjusts the volume for Mic Channel 2.

1. Turn the volume knob clockwise to raise the volume for that microphone channel
2. Turn the volume knob counter-clockwise to lower the volume for that microphone channel.

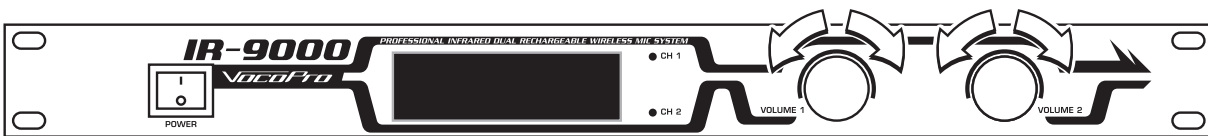

Charging the Microphones

1. Place one or both microphones in the charger slots
2. The LED on the charger will be red when the microphone is charging and green when it is charged

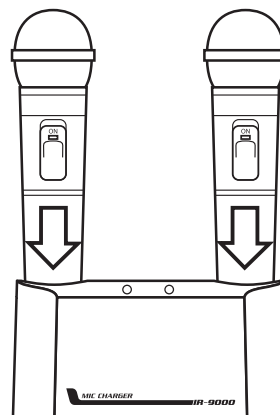

Descriptions and Functions

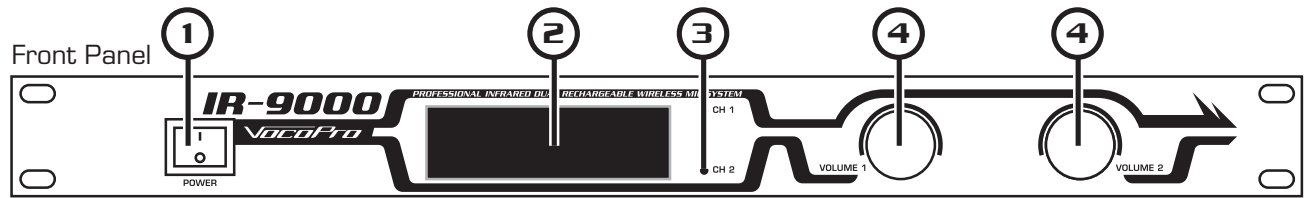

Receiver Front Panel

- 1. Power switch** - Turns the receiver unit's power on and off
- 2. Infrared Sensor** - This is the built-in infrared sensor. Make sure there is a clear path between the microphones and this sensor. For increased signal strength you can add up to two external infrared sensors. See the getting connected section for instructions on connecting external infrared sensors.
- 3. LED Channel Indicators** - Each of these two LED indicators will light up when the corresponding microphone is switched on and an infrared connection is made to the IR-9000. The indicator(s) will remain lit as long as the infrared connection is maintained.
- 4. Microphone Volume controls** - Controls the volume for each microphone channel. Turn clockwise to raise the microphone volume and counter-clockwise to lower the microphone volume.

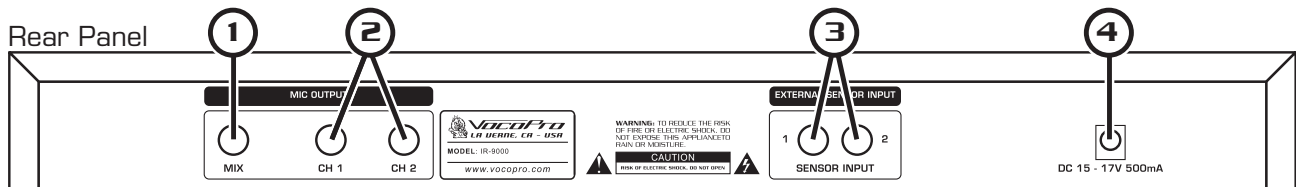

Receiver Rear Panel

- 1. Mixed Output 1/4" jack** - Outputs both microphone channels on a single channel using a 1/4" microphone cable.
- 2. Independent Microphone Output 1/4" jacks** - Connect each microphone channel independently using a 1/4" microphone cable.
- 3. Infrared Sensor input jacks** - Connect up to two external infrared sensors here. The IR-9000 includes one external infrared sensor. A second one can be purchased from your VocoPro dealer.
- 4. DC Input** - Connect the DC adaptor here to power the unit.

Descriptions and Functions cont.

Microphone

1. **Power Switch** - Turns the microphone's power on and off
2. **Power indicator LED** - Indicates when the microphone's power is on.
4. **IR Transmitter** - This lens emits the infrared signal to the sensor on the receiver.
Note: Keep hands away from this part of the microphone, as it may block the infrared signal.
4. **Gain Control** - Turn this control clockwise to increase the gain output of the microphone, turn counter-clockwise to decrease.
5. **Signal Hi/Lo Switch** - Use this switch to toggle from a "hi" or "lo" signal strength that will give your microphone signal an extra boost if you would like to extend the range of the microphone. Note: The high setting will cause more power use and drain the battery faster than the low setting.

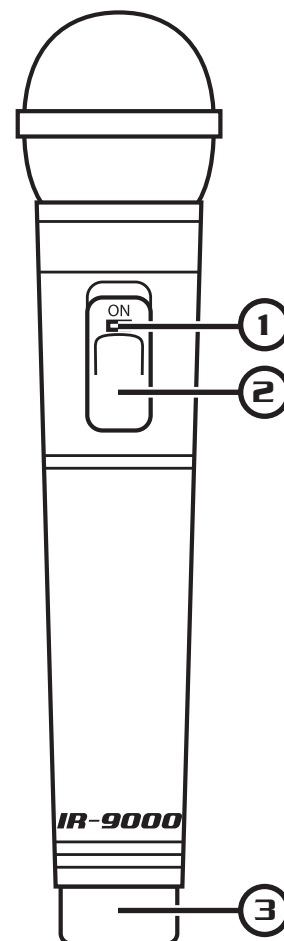
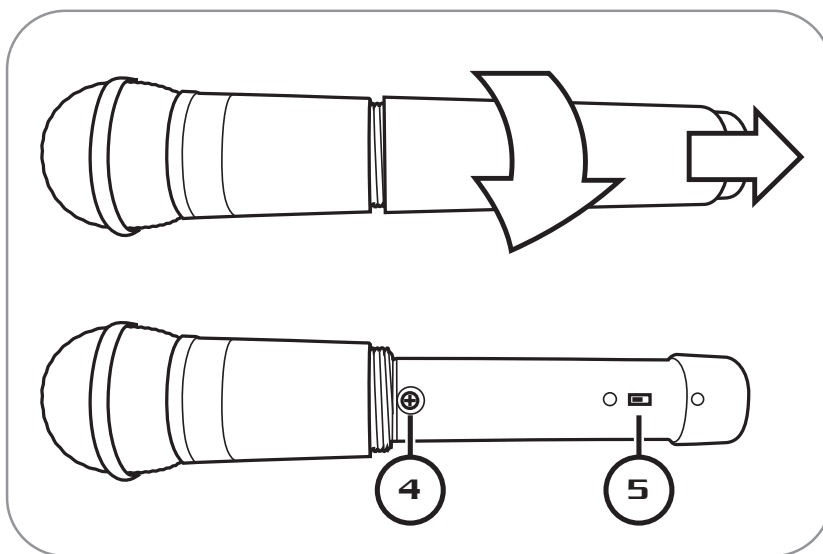

Microphone Charger

1. **Charging slots** - Place the microphones in these slots to charge.
2. **LED charge indicators** - indicate the charge level of each microphone. Red indicates that the microphone is charging and green indicates that the microphone is charged.

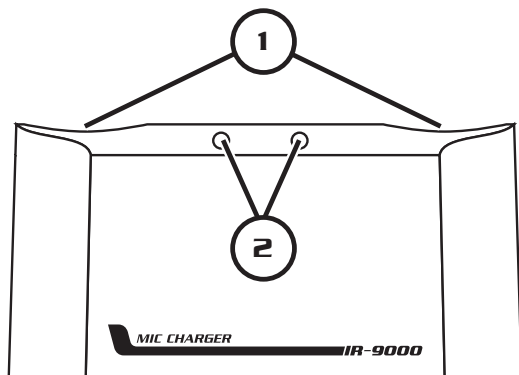

Troubleshooting

There is no power

- Make sure the correct power adapter is connected to the receiver
- If using a surge protector / power strip, make sure it is plugged in and switched on
- Make sure all power connections are fully connected

There is no sound or the sound is unclear

- Make sure all cables are fully inserted into the correct inputs and outputs. See the Getting Connected section in this manual for detailed instructions on setting up the IR-9000.
- Make sure all of the volume controls on the IR-9000 and on your other components are turned up
- Make sure there is no barrier between the microphones and the infrared sensor(s)
- Make sure the microphones are charged
- Move closer to the receiver or one of the other infrared sensors. Add another infrared sensor to the room if necessary.

Technical Specifications

Transmitter

Working Voltage: DC 2-3V

Working Frequency: A: 2.08MHz, B: 2.54MHz

Continuous working time: 5hr

Receiver

Power Consumption: 7W

Audio Output: 600Ω/300mV

S/N:>100dB

Frequency response: 45Hz-15KHz ± 3dB

Working Distance(forward): >10m

Working Range: >30m²

Power Adapter

Input: AC 110V 60Hz

Output: DC 15V 500mA

Charger

Charge voltage/current: DC 3.2V 350mA x2

Charge time: about 6hr

Power Adapter

Input: AC 110V 60Hz

Output: DC 9V 800mA

VocoPro[®]

THE SINGER'S ULTIMATE CHOICE[™]

