

# HEAT CONTROLLER, INC. Wall Mounted Mini-Split System

VMC30SB-1

## Inverter Single-Zone Air Conditioning

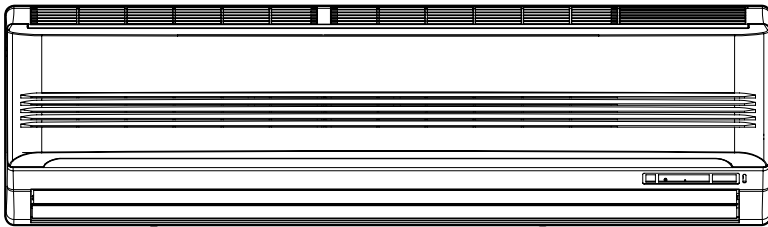

## *Owner's Manual*

### ***Important Information***

- Please read carefully and thoroughly this manual before operating this unit.
- Contact a qualified service technician for installation, repair and maintenance of this unit.
- The appliance is not intended for use by young children or those who require supervision.
- Young children should be supervised to ensure that they do not play with the appliance.

# TABLE OF CONTENTS

<b>A. Safety Precautions</b> .....	3
<b>B. Electrical Safety</b> .....	6
Temporary Use of an Adapter .....	6
Symbols used in this Manual .....	6
<b>C. Product Introduction</b> .....	7
Indoor Units .....	7
Operation Indication Lamps .....	7
Outdoor Unit .....	7
<b>D. Operating Instructions</b> .....	8
How to insert the Batteries .....	8
Wireless Remote Controller	
Maintenance .....	8
Operating Method .....	8
Wireless Remote Controller .....	9
Operation Mode .....	10
Healthy Dehumidification Operation .....	11
Jet Cool Operation .....	11
Auto Clean .....	11
Energy-Saving Cooling Mode .....	12
Forced operation .....	12
Sleep Mode .....	13
Setting the Current Time .....	13
Timer Setting .....	13
Vertical / Horizontal Airflow Direction	
Control (Optional) .....	14
Auto Restart Function .....	14
<b>E. Maintenance and Service</b> .....	15
Indoor Unit .....	15
Outdoor Unit .....	16
Operation Tips! .....	16
Self-Diagnosis Function .....	16
Troubleshooting Tips!	
Save time and money! .....	17
Call the service immediately in the	
following situations .....	17



## FOR YOUR RECORDS

Write the model and serial numbers here:

**Model #** \_\_\_\_\_

**Serial #** \_\_\_\_\_

You can find them on a label on the side of each unit.

**Dealer's Name** \_\_\_\_\_

**Date Purchased** \_\_\_\_\_

■ Staple your receipt to this page in the event you need it to prove date of purchase or for warranty issues.



## READ THIS MANUAL

Inside you will find many helpful hints on how to use and maintain your air conditioner properly. Just a little preventive care on your part can save you a great deal of time and money over the life of your air conditioner.

You'll find many answers to common problems in the chart of troubleshooting tips. If you review our chart of

**Troubleshooting Tips** first, you may not need to call for service at all.



## PRECAUTION

- **Contact the authorized service technician for repair or maintenance of this unit.**
- **Contact the installer for installation of this unit.**
- **The air conditioner is not intended for use by young children without supervision.**
- **Young children should be supervised to ensure that they do not play with the air conditioner.**
- **When the power cord is to be replaced, replacement work shall be performed by authorized personnel only using only genuine replacement parts.**

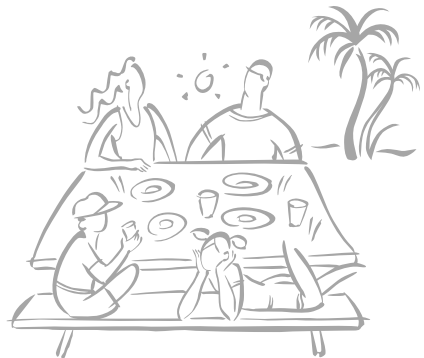

# Safety Precautions

To prevent injury to the user or other people and property damage, the following instructions must be followed.

- Incorrect operation due to ignoring instructions will cause harm or damage. The seriousness is classified by the following indications.

**⚠ WARNING** This symbol indicates the possibility of death or serious injury.

**⚠ CAUTION** This symbol indicates the possibility of injury or damage.

- Meanings of symbols used in this manual are as shown below.



**Be sure not to do.**



**Be sure to follow the instruction.**

## ⚠ WARNING

**Always use a power plug and socket with a ground terminal.**

- There is a risk of electric shock.

**For electrical work, contact the dealer, seller, a qualified electrician, or an Authorized Service Center. Do not disassemble or repair the product by yourself.**

- There is risk of fire or electric shock.

**Use the correctly rated breaker or fuse.**

- There is risk of fire or electric shock.

**Do not install the product on a defective installation stand. Be sure that the installation area does not deteriorate with age.**

- It may cause product to fall.

**In outdoor unit the step-up capacitor supplies high voltage electricity to the electrical components. Be sure to discharge the capacitor completely before conducting the repair work.**

- An charged capacitor can cause electrical shock.

**Do not use a defective or underrated circuit breaker. Use the correctly rated breaker and fuse.**

- There is risk of fire or electric shock .

**Always ground the product as per the wiring diagram. Do not connect the ground wire to gas or water pipes lightning rod or telephone ground wire.**

- There is risk of fire or electric shock.

**Do not modify or extend the power cable. If the power cable or cord has scratches or skin peeled off or deteriorated then it must be replaced.**

- There is risk of fire or electric shock.

**Never install the outdoor unit on a moving base or a place from where it can fall down.**

- The falling outdoor unit can cause damage or injury or even death of a person.

**When installing the unit, use the installation kit provided with the product.**

- Otherwise the unit may fall and cause severe injury.

**Do not use a multi consent. Always use this appliance on a dedicated circuit and breaker.**

- Otherwise it can cause electric shock or fire.

**Install the panel and the cover of control box securely.**

- There is risk of fire or electric shock due to dust , water etc.

**For installation, removal or reinstall , always contact the dealer or an Authorized Service Center.**

- There is risk of fire, electric shock, explosion, or injury.

**When the product is soaked (flooded or submerged) in water , contact an Authorized Service Center for repair before using it again.**

- There is risk of fire or electric shock.

**Be sure to use only those parts which are listed in the svc parts list. Never attempt to modify the equipment.**

- The use of inappropriate parts can cause an electrical shock, excessive heat generation or fire.

## Safety Precautions

**Indoor/outdoor wiring connections must be secured tightly and the cable should be routed properly so that there is no force pulling the cable from the connection terminals.**

- Improper or loose connections can cause heat generation or fire.

**Please use the correct refrigerant type specified for the product. Please read the label on the product.**

- Incorrect refrigerant used can prevent the normal operation of the unit.

**Do not place a heater or other heating appliances near the power cable.**

- There is risk of fire and electric shock.

**Do not use the product in a tightly closed space for a long time. Ventilate the room regularly.**

- Oxygen deficiency could occur and hence harm your health.

**Ventilate the product room from time to time when operating it together with a stove, or heating element etc.**

- Oxygen deficiency can occur and hence harm your health.

**Take care to ensure that nobody, especially kids, could step on or fall onto the outdoor unit.**

- This could result in personal injury and product damage.

**Do not plug or unplug the power supply plug to turn the unit ON/OFF .**

- There is risk of fire or electric shock.

**Safely dispose of packing materials, sharp objects (nails), plastic bags, batteries, etc. after installation or service.**

- Children may play with them and cause injury.

**Don't use a power cord, a plug or a loose socket which is damaged.**

- Otherwise it may cause a fire or electrical shock.

**Do not allow water to run into electric parts. Install the unit away from water sources.**

- There is risk of fire, failure of the product, or electric shock.

**Do not open the front grille of the product during operation. (Do not touch the electrostatic filter, if the unit is so equipped.)**

- There is risk of physical injury, electric shock, or product failure.

**Turn the main power off and unplug the unit when cleaning or repairing the product.**

- There is risk of electric shock.

**Take care to ensure that power cable could not be pulled out or damaged during operation.**

- There is risk of fire or electric shock.

**Make sure to check that the power cable plug is not dirty, loose or broken and then only insert the plug completely.**

- Dirty, loose or broken power plug can cause electric shock or fire.

**Do not touch, operate, or repair the product with wet hands. Hold the plug by hand when taking out**

- There is risk of electric shock or fire.

**Do not store or use or even allow flammable gas or combustibles near the product.**

- There is risk of fire.

**If strange sounds, smell or smoke comes from product. Immediately turn the breaker off or disconnect the power supply cable.**

- There is risk of electric shock or fire.

**When the product is not to be used for a long time, disconnect the power supply plug or turn off the breaker.**

- There is risk of product damage or failure, or unintended operation.

**Do not place ANYTHING on the power cable.**

- There is risk of fire or electric shock.

**When flammable gas leaks, turn off the gas and open a window for ventilation before turning the product on.**

- Do not use any equipment or turn power switches on or off. There is risk of explosion or fire.

## CAUTION

**Two or more people must lift and transport the product.**

- Avoid personal injury.

**Keep level even when installing the product.**

- To avoid vibration or noise.

**Do not install the product where it will be exposed to sea wind (salt spray) directly.**

- It may cause corrosion on the product.

**Do not install the product where the noise or hot air from the outdoor unit could damage or disturb the neighbor.**

- It may cause a problem for your neighbors and hence dispute.

**Install the drain hose to ensure that the condensed water is drained away properly.**

- A bad connection may cause water leakage.

**Always check for gas (refrigerant) leakage after installation or repair of product.**

- Low refrigerant levels may cause failure of product.

**Do not use the product for special purposes, such as preserving foods, works of art, etc. It is a consumer air conditioner, not a precision refrigeration system.**

- There is risk of damage or loss of property.

**Do not block the inlet or outlet of air flow.**

- It may cause product failure.

**Use a soft cloth to clean. Do not use harsh detergents, solvents or splashing water etc .**

- There is risk of fire, electric shock, or damage to the plastic parts of the product.

**Do not touch the metal parts of the product when removing the air filter.**

- There is risk of personal injury.

**Do not step on or put anything on the product. (outdoor units)**

- There is risk of personal injury and failure of product.

**Always insert the filter securely after cleaning. Clean the filter every two weeks or more often if necessary.**

- A dirty filter reduces the efficiency.

**Do not insert hands or other objects through the air inlet or outlet while the product is operating.**

- There are sharp and moving parts that could cause personal injury.

**Be cautious when unpacking and installing the product.**

- Sharp edges could cause injury.

**If the refrigerant gas leaks during the repair, ventilate the area and do not touch the refrigerant gas.**

- The refrigerant gas can cause frostbite (cold burn)

**Do not tilt the unit when removing or uninstalling it.**

- The condensed water inside can spill .

**Do not mix air or gas other than the specified refrigerant used in the system .**

- If air enters the refrigerant system, an excessively high pressure results, causing equipment damage or injury.

**If the refrigerant gas leaks during the installation, ventilate the area immediately.**

- Otherwise it can be harmful for your health.

**Dismantling the unit, treatment of the refrigerant oil and eventual parts should be done in accordance with local and national standards.**

**Replace the all batteries in the remote control with new ones of the same type. Do not mix old and new batteries or different types of batteries.**

- There is risk of fire or product failure.

**Do not recharge or disassemble the batteries. Do not dispose of batteries in a fire.**

- They may burn or explode.

**If the liquid from the batteries gets onto your skin or clothes, rinse well with water and contact your doctor or local poison control center. Do not use the remote if the batteries have leaked.**

- The chemicals in batteries could cause burns or other health hazards.

**If you consume the liquid from the batteries, rinse your mouth with water and contact your doctor or local poison control center. Do not use the remote if the batteries have leaked.**

- The chemicals in batteries could cause burns or other health hazards.

**Do not let the air conditioner run for a long time when the humidity is very high and a door or a window is left open.**

- Moisture may condense and wet or damage furniture.

**Humans, pets, and plants should avoid direct exposure to the cool or hot air discharge/draft.**

- This could harm to your health.

**Do not drink the water drained from the product.**

- It is not sanitary and could cause serious health issues.

**Use a firm stool or ladder when cleaning, maintaining or repairing the product at elevated heights.**

- Be careful and avoid personal injury.

# Electrical Safety

## **⚠ WARNING**

- This appliance must be properly grounded.  
To minimize the risk of electric shock, you must always plug into a grounded outlet.
- Do not cut or remove the grounding prong from the power plug.
- Attaching the adapter ground terminal to the wall receptacle cover screw does not ground the appliance unless the cover screw is metal and not insulated, and the wall receptacle is grounded through the house wiring.
- If you have any doubt whether the air conditioner is properly grounded, have the wall receptacle and circuit checked by a qualified electrician.

## *Temporary Use of an Adapter*

We strongly discourage the use of an adapter due to potential safety hazards. For temporary connections, use only a genuine adapter, available from most local hardware stores. Ensure that the large slot in the adapter is aligned with the large slot in the receptacle for a proper polarity connection.

To disconnect the power cord from the adapter, use one hand on each to avoid damaging the ground terminal. Avoid frequently unplugging the power cord as this can lead to eventual ground terminal damage.

## **⚠ WARNING**

- Never use the appliance with a broken adapter.

## *Symbols used in this Manual*



This symbol alerts you to the risk of electric shock.



This symbol alerts you to hazards that may cause harm to the air conditioner.

**NOTE**

This symbol indicates special notes.



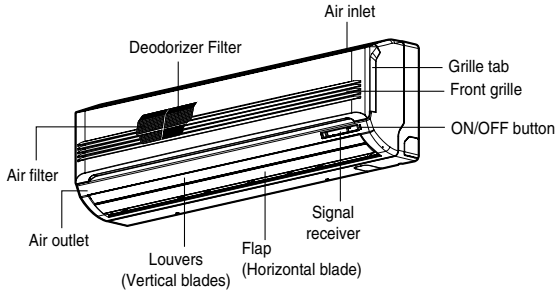

# Product Introduction

Here is a brief introduction of the indoor and outdoor units. Please see the information specific to your indoor unit type.

## Indoor Units



## Operation Indication Lamps

-  **On/Off** : Lights up during the system operation, error code and auto restart setting.
-  **Sleep mode** : Lights up during sleep mode auto operation.
-  **Timer** : Lights up during timer operation or sleep mode auto operation.
- OUT DOOR** **operation** : Lights up during outdoor unit operation. (Cooling model only)
-  **Power Display** : Indicates the setting temperature and operation mode.

Operation mode	JetCool	Energy-saving cooling mode	Test operation	Auto clean
Shape of display	<i>Po</i>	<i>Eo</i>	<i>Lo</i>	<i>Co</i>

## Outdoor Unit

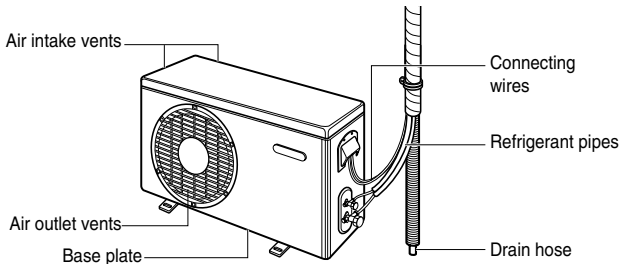

# Operating Instructions

## How to insert the Batteries

1. Remove the battery cover by pulling it according to the arrow direction.
2. Insert new batteries making sure that the (+) and (-) of battery are installed correctly. (Battery Size: AAA 1.5V)
3. Reattach the cover by sliding it back into position.

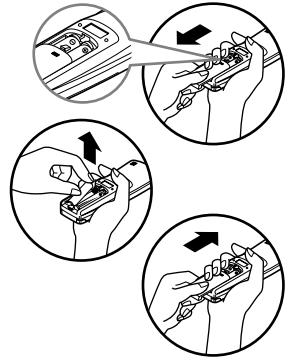

### NOTE

1. Always use/replace both batteries of same type.
2. If the system is not to be used for a long time, remove the batteries to save their working life.
3. If the display screen of remote controller starts, fading replace both of the batteries.

## Wireless Remote Controller Maintenance

1. Choose a suitable place where its safe & easy to reach.
2. Fix the holder to wall etc with the supplied screws firmly.
3. Slide the remote controller inside the holder.

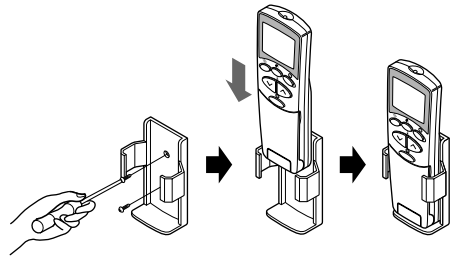

### NOTE

1. Remote controller should never be exposed to direct sunlight.
2. Signal transmitter & receiver should always be clean for proper communication. Use a soft cloth to clean them.
3. In case some other appliances also get operated with remote control, change their position or consult your serviceman.

## Operating Method

1. The signal receiver is inside the unit.
2. Aim the remote controller towards the unit to operate it. There should not be any blockage in between.

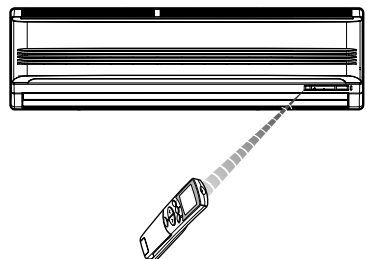



## Wireless Remote Controller

The controls will look like the following.

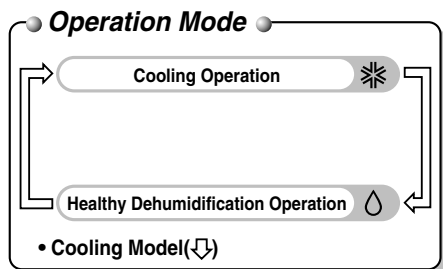
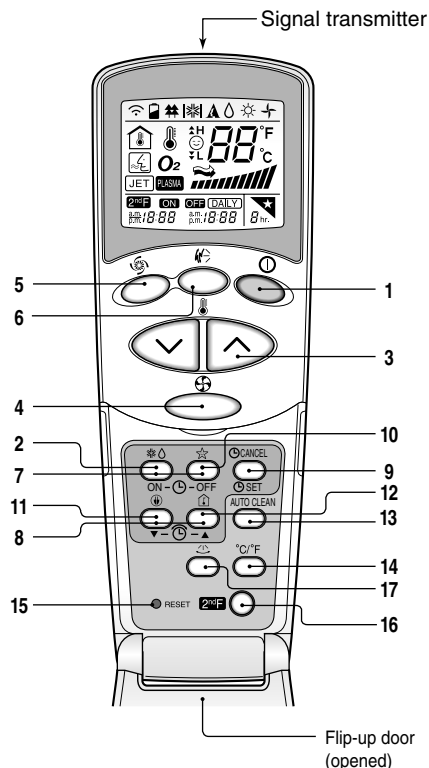

- 1. START/STOP BUTTON**  
Used to turn off/on the unit.
- 2. OPERATION MODE SELECTION BUTTON**  
Used to select the operation mode.
- 3. ROOM TEMPERATURE SETTING BUTTONS**  
Used to select the room temperature.
- 4. INDOOR FAN SPEED SELECTOR BUTTON**  
Used to select fan speed in four steps low, medium, high and CHAOS.
- 5. JET COOL BUTTON**  
Used to start or stop the speed cooling.  
(It operates fan in super high speed.)
- 6. CHAOS SWING BUTTON**  
Used to stop or start louver movement and set the desired up/down airflow direction.
- 7. ON/OFF TIMER BUTTONS**  
Used to set the time of starting and stopping operation.
- 8. TIME SETTING BUTTONS**  
Used to adjust the time.
- 9. TIMER SET/CANCEL BUTTON**  
Used to set and to cancel the timer operation.
- 10. SLEEP MODE AUTO BUTTON**  
Used to set sleep mode auto operation.
- 11. ENERGY-SAVING COOLING MODE BUTTON**  
Used to save Energy.
- 12. ROOM TEMPERATURE CHECKING BUTTON**  
Used to check the room temperature.
- 13. AUTO CLEAN BUTTON**  
Used to set auto clean mode.
- 14. °C TO °F SWITCHING BUTTON**  
Used to switch temperature reading from Centigrade to Fahrenheit.
- 15. RESET BUTTON**  
Used prior to resetting time.
- 16. 2nd F BUTTON**  
Used prior to using modes printed in blue at the bottom of buttons.
- 17. HORIZONTAL AIRFLOW DIRECTION CONTROL BUTTON (OPTIONAL)**  
Used to set the desired horizontal airflow direction.

### NOTE

To use the functions printed in blue at the bottom of the buttons press 2<sup>nd</sup> F button first and then the required function button. Pressing the 2<sup>nd</sup> F button activates the blue printed function of the respective button. To cancel the function press the 2<sup>nd</sup> F button again else it will automatically cancel if remains idle after 10 seconds.

## Operation Mode

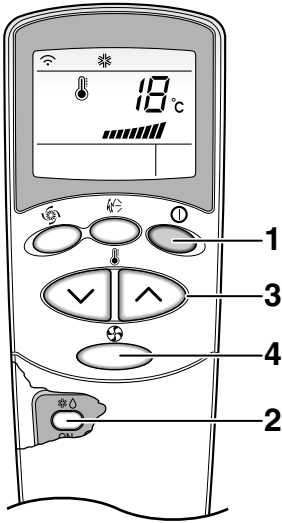

- 1** Press the START/STOP BUTTON to turn the unit on.  
The unit will respond with a beep.



- 2** Open the door of the remote controller and press the operation mode button. Each time the button is pressed, the operation mode is shifted in the direction of the arrow.

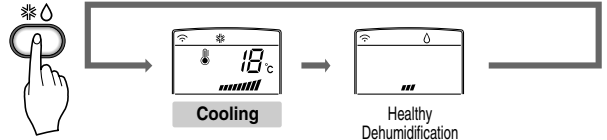

- 3** For cooling operation set the desired indoor temperature by pressing the ROOM TEMPERATURE SETTING BUTTONS. For cooling the temperature can be set within 18°C~30°C (64°F~86°F).

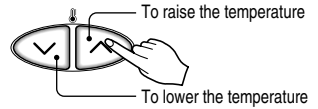

- 4** Set the fan speed with the remote controller. You can select the fan speed in four steps-low, medium, high and CHAOS by pressing the INDOOR FAN SPEED SELECTOR BUTTON. Each time the button is pressed, the fan speed mode is shifted.

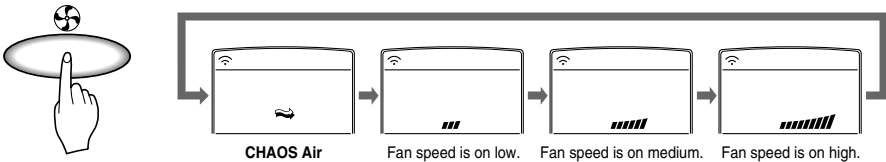

### Natural wind by the CHAOS logic

- For fresher feeling, press the INDOOR FAN SPEED SELECTOR BUTTON selector and set to CHAOS mode. In this mode, the wind blows like a natural breeze by automatically changing fan speed according to the CHAOS logic.

## Healthy Dehumidification Operation

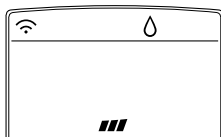

**Healthy  
Dehumidification**



### During Healthy Dehumidification Operation

❑ If you select the dehumidification mode on the OPERATION MODE SELECTION BUTTON, the product starts to run the dehumidification function. It automatically sets the room temperature and airflow volume to the best condition for dehumidification, based on the sensed current room temperature.

In this case, however, the setting temperature is not displayed on the remote controller and you are not able to control the room temperature either.

❑ During the healthy dehumidification function, the airflow volume is automatically set according to the optimization algorithm responding to the current room temperature status, so that the room condition is kept healthy and comfortable even in the very humid season.

*To run the healthy dehumidification mode follow steps 1, and 2 and 4 (See operation mode)*

## Jet Cool Operation

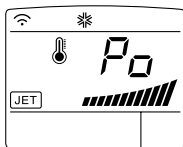

Jet cool function can be used to cool the room quickly in hot summer. When this function is turned on, the air conditioner runs in cooling operation mode with super high fan speed and 18°C(64°F) setting temperature for 30 minutes for fast and effective cooling.

You can activate this operation by pressing the JET COOL BUTTON.

To change from jet cool mode to high fan speed cooling mode, press the JET COOL BUTTON or INDOOR FAN SPEED SELECTOR BUTTON or the ROOM TEMPERATURE SETTING BUTTON again.



## Auto Clean

❑ During auto clean function, moistures left in indoor units after cooling operation or healthy dehumidification operation can be removed.

AUTO CLEAN



1. Press the AUTO CLEAN BUTTON to activate this function.
2. Now whenever the unit is turned off, the indoor fan is still running for about 30 minutes internally without cooling or dehumidification operation. Also the louver is closed.
3. This dries up any remains of moisture & cleans the unit internally.
4. If you press AUTO CLEAN BUTTON again during operation, this function is cancelled.

### NOTE

❑ During auto clean function, only START/STOP BUTTON and AUTO CLEAN BUTTON can be used.

## Energy-Saving Cooling Mode

Energy-saving cooling mode can save energy in cooling and healthy dehumidification operation, because it can operate efficiently by setting body-adaptation time according to the change of time and temperature and adjusting automatically desired temperature.



1. Press the START/STOP BUTTON to start the unit.
2. Open the door on the remote controller.  
Select cooling operation or healthy dehumidification operation.
3. Press the ENERGY-SAVING COOLING MODE BUTTON.
4. To cancel the energy-saving cooling mode, press the ENERGY-SAVING COOLING MODE BUTTON again and unit will operate in previous mode(Cooling or healthy dehumidification mode).

## Forced operation

Operation procedures when the remote control can't be used.  
The operation will be started if the ON/OFF button is pressed.  
If you want to stop operation, re-press the button.

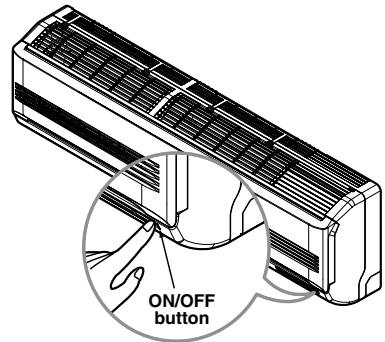

	Cooling Model
Operating mode	Cooling
Indoor FAN Speed	High
Setting Temperature	22°C(71.6°F)

## Test operation

During the TEST OPERATION, the unit operates in cooling mode at high speed fan, regardless of room temperature and resets in 18 minutes.

During test operation, if remote controller signal is received, the unit operates as remote controller sets.

If you want to use this operation, Press and hold the ON/OFF button for 3~5 seconds, then the buzzer will sound 1 "beep".

If you want to stop the operation, re-press the button.

## Sleep Mode

1. Press the SLEEP MODE AUTO BUTTON to set the time when you want the unit to stop automatically. 
2. The timer is programmed in one-hour increments by pressing the SLEEP MODE AUTO BUTTON 1 to 7 times.  
The sleep mode is available for 1 to 7 times.  
To alter the time period in steps of 1 hour, press the SLEEP MODE AUTO BUTTON while aiming at air conditioner.
3. Make sure the Timer LED lights up.  
To cancel the sleep mode, press the SLEEP MODE AUTO BUTTON several times until the Timer LED lights off.



### NOTE

- The sleep mode will operate indoor fan at slow speed in cooling mode.

### In cooling mode or healthy dehumidification mode:

The setting temperature will rise automatically two times by 1°C(2°F) over next consecutive 30 minutes [2°C(4°F) in 1 hour] for a comfortable sleep. Now this will be the final setting temperature as long as sleep mode is functioning.



## Setting the Current Time

1. Time can be set only when you press the RESET BUTTON. Having replacing the batteries, you should press the RESET BUTTON to reset the time. Press the Start/Stop button. 
2. Press 2nd F button and check if 2<sup>nd</sup>F icon is on.
3. Press the TIME SETTING BUTTONS until the desired time is set. 
4. Press the TIME SET/CANCEL BUTTON. 

### NOTE

Check the indicator for A.M. and P.M.

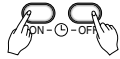
## Timer Setting

1. Make sure to set current time correctly on the display of the remote controller.
2. Press 2nd F button.
3. Press the ON/OFF TIMER BUTTONS to turn timer on or off. 
4. Press the TIME SETTING BUTTONS until the desired time is set. 
5. To set the selected time, press the TIMER SETTING BUTTONS aiming the remote controller at the signal receptor. 

### To cancel the timer setting

Check if 2<sup>nd</sup>F icon is off.

Press the TIMER CANCEL BUTTON aiming the remote controller at the signal receptor. (The timer lamp on the air conditioner and the display will go off.) 

### NOTE

Select one of the following four types of operation.



Delay off timer



Delay on timer



Delay off and on timer



Delay on and off timer

## Vertical / Horizontal Airflow Direction Control (Optional)

The up/down airflow (Vertical airflow) can be adjusted by using the remote controller.

1. Press the START/STOP BUTTON to start the unit.

2. Press CHAOS SWING BUTTON.



3. The louvers will swing up & down automatically.



4. To stop the louver at a desired angle, press  again

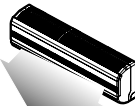

The left/right(Horizontal airflow) can be adjusted by using the remote control.

1. Press the START/STOP BUTTON to start the unit.

2. Press the HORIZONTAL AIRFLOW DIRECTION BUTTON.



3. The louvers will swing left & right automatically.

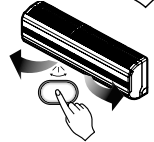

4. To stop the louvers at a desired angle, press  again.

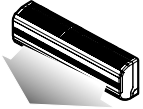

### NOTE

- By pressing the CHAOS SWING BUTTON the horizontal air flow direction is changed automatically based on the chaos algorithm to distribute the air in the room evenly and at the same time to make the human body feel most comfortable as if enjoying natural breeze.
- Always use the remote controller to adjust the up and down air flow direction. Manually moving the vertical air flow direction louver by hand could damage the mechanism. When the unit is shut off, the up/down airflow direction louver will close the air outlet vent of the system.

## Auto Restart Function

This function is useful in the situation of power failure.

When power regains after a failure this feature restores the previous operating condition and the air conditioner will run with the same settings.

### NOTE

This feature is enabled by factory default setting, but you can disable it by pressing the ON/OFF button for 6 seconds. The unit will beep twice and the indicator lamp(2) will blink 4 times. To enable it, press the button again for 6 seconds. The unit will beep twice and the indicator lamp(1) will blink 4 times.

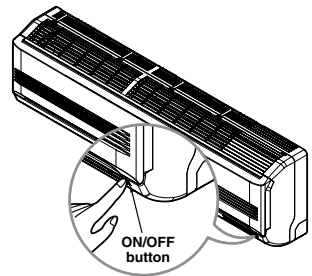

# Maintenance and Service

## ⚠ CAUTION

Before performing any maintenance, turn off the main power to the system, disconnect the circuit breaker and unplug the power cord.

## Indoor Unit

Clean the unit with a soft dry cloth. Do not use bleach or abrasives.

## ⚠ CAUTION

Never use any of these

- Water hotter than 40°C(104°F). It may cause deformation and discoloration.
- Volatile substances. They may damage the surface of the air conditioner.



## Air Filters

The air filters behind the front panel / grill should be checked and cleaned once in every 2 weeks or more often if necessary. To remove the filters see the self explanatory diagrams for each model type. Clean the filters with a vacuum cleaner or warm soapy water. If dirt is not easily removed, wash with a solution of detergent in luke warm water. Dry well in shade after washing and reinstall the filters back in place.

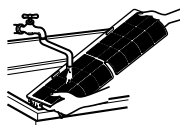

## Deodorizer Filters

Remove the deodorizer filters behind the air filter and expose them in direct sunlight for 2 hours.

And then insert these filters into original position.



## Removal of Filters

Open the front panel as shown.

Then pull the filter tab slightly forward to remove the air filter.

After removing the air filter remove the deodorizer filter by slightly pulling forward.

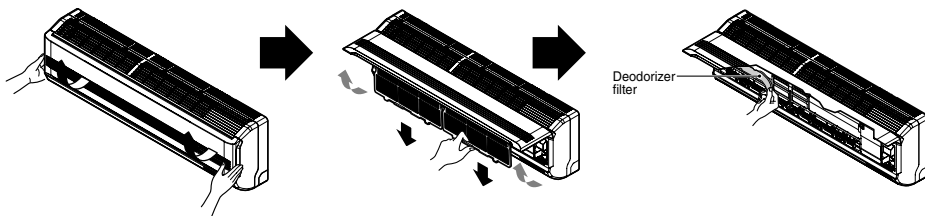

## Outdoor Unit

The heat exchanger coils and panel vents of the outdoor unit should be checked regularly. If clogged with dirt or soot, the heat exchanger and panel vents may be professionally steam cleaned.

### NOTE

Dirty or clogged coils will reduce the operating efficiency of the system and cause higher operating costs.

## Operation Tips!

### Do not overcool the room.

This is not healthy and wastes electricity.

### Keep blinds or curtains closed.

Do not let direct sunshine enter the room when the air conditioner is in operation.

### Keep the room temperature uniform.

Adjust the vertical and horizontal airflow direction to ensure a uniform temperature in the room.

### Make sure that the doors and windows are shut tight.

Avoid opening doors and windows as much as possible to keep the cool air in the room.

### Clean the air filter regularly.

Blockages in the air filter reduce the airflow and lower cooling and dehumidifying effects. Clean at least once every two weeks.

### Ventilate the room occasionally.

Since windows are kept closed, it is a good idea to open them and ventilate the room now and then.

### Use high fan speed for effective and fast cooling.

The unit gives its rated cooling capacity when the fan speed is high.

## Self-Diagnosis Function

This unit has an inbuilt error diagnosis capability. Unit LED (①) will blink in case if thermistor fails. Please contact your serviceman/dealer in such a situation

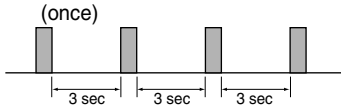
Error Display LED (①)	Check Point
 <p>(once)</p> <p>3 sec 3 sec 3 sec</p>	<ul style="list-style-type: none"> <li>Indoor room temperature thermistor open/short.</li> <li>Indoor pipe temperature thermistor open/short.</li> </ul>



## Troubleshooting Tips! Save time and money!

### The air conditioner may be operating abnormally when:

Problem	Possible Causes	What To Do
Air conditioner does not start	■ The air conditioner is unplugged.	• Make sure the air conditioner plug is pushed completely into the outlet.
	■ The fuse is blown/circuit breaker is tripped.	• Check the house fuse/circuit breaker box and replace the fuse or reset the breaker.
	■ Power failure.	• If power failure occurs, turn the mode control to OFF. When power is restored, wait 3 minutes to restart the air conditioner to prevent tripping of the compressor overload.
	■ High voltage.	• If the voltage is unusually very high or low the Circuit Breaker will trip.
Air conditioner does not cool as it should	■ Airflow is restricted.	• Make sure there are no curtains, blinds, or furniture blocking the front of the air conditioner.
	■ The air filter is dirty.	• Clean the filter at least every 2 weeks. See the Maintenance and Service section.
	■ The room may have been hot.	• When the air conditioner is first turned on, you need to allow time for the room to cool down.
	■ Cold air is escaping.	• Check for open furnace floor registers and cold air returns.
	■ Check the temperature settings.	• Make sure they are correct.
	■ There might be a heating source in the room.	• Check and remove such source or turn it off while using the air conditioner.

### Call the service immediately in the following situations

1. Anything abnormal such as burning smell, loud noise etc. happens. Stop the unit and turn the breaker off. Never try to repair by yourself or restart the system in such cases.
2. Main power cord is too hot or damaged.
3. Error code is generated by self diagnosis.
4. Water leaks from indoor unit even if the humidity is low.
5. Any switch, breaker (safety, ground) or fuse fails to work properly

**User must carry routine checkup & cleaning to avoid poor performance.  
Any other types of service must be carried out by service person only.**

**Specifications and performance data subject to change without notice.**

## **HEAT CONTROLLER, INC.**

1900 WELLWORTH AVENUE • JACKSON, MICHIGAN 49203

*THE QUALITY LEADER IN CONDITIONING AIR*