

**PYLE®
view**

**Operating
Instructions**

PL71PHB

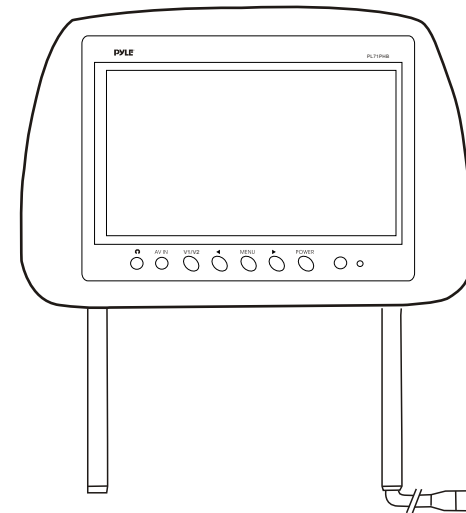
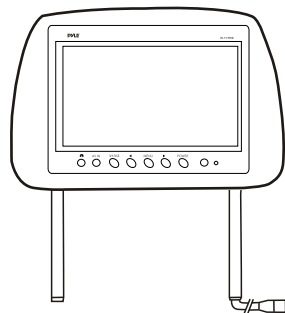

[HTTP://WWW.PYLEAUDIO.COM](http://www.pyleaudio.com)

It is pleased that you use the LCD products. To ensure a long term life of the product and your complete use in the product, you shall read the instruction carefully and save it in good condition for demand in the future.

APPEARANCE AND FUNCTION

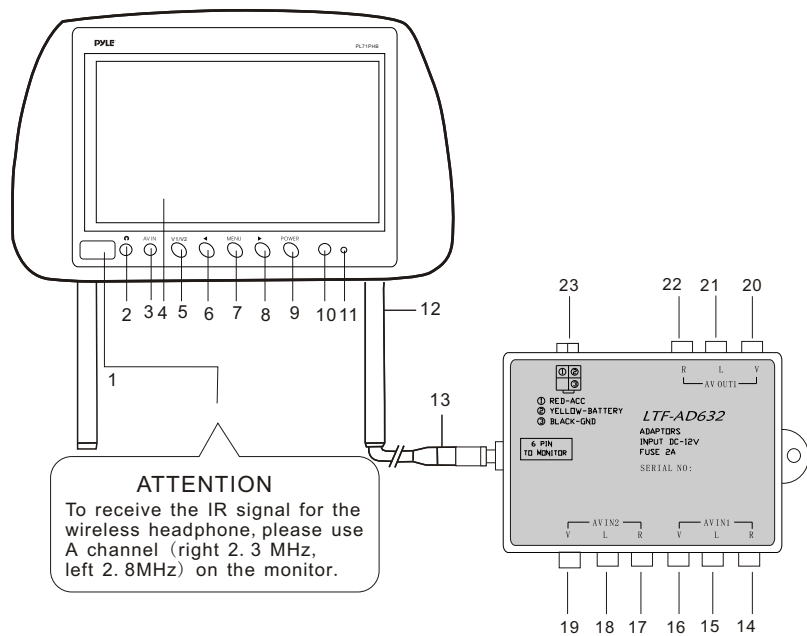

ATTENTION
To receive the IR signal for the wireless headphone, please use A channel (right 2.3 MHz, left 2.8MHz) on the monitor.

- 1. Wireless Headphone Transmitter
- 2. Audio out(headphones)
- 3. Audio/video in
- 4. Color LCD Screen
- 5. V1/V2 (Video1, Video2)
- 6. Reduce Button
- 7. Menu(brightness. Color.contrast)buttons
- 8. Increase Button
- 9. Power on/off
- 10. Remote controller receiver
- 11. Power indicator light
- 12. Removable tube spacer
- 13. Monitor Connector

- 14. AV1 Audio right input
- 15. AV1 Audio left input
- 16. AV1 Video input
- 17. AV2 Audio right input
- 18. AV2 Audio left input
- 19. AV2 Video input
- 20. Video output
- 21. Audio left output
- 22. Audio right output
- 23. 12V power input

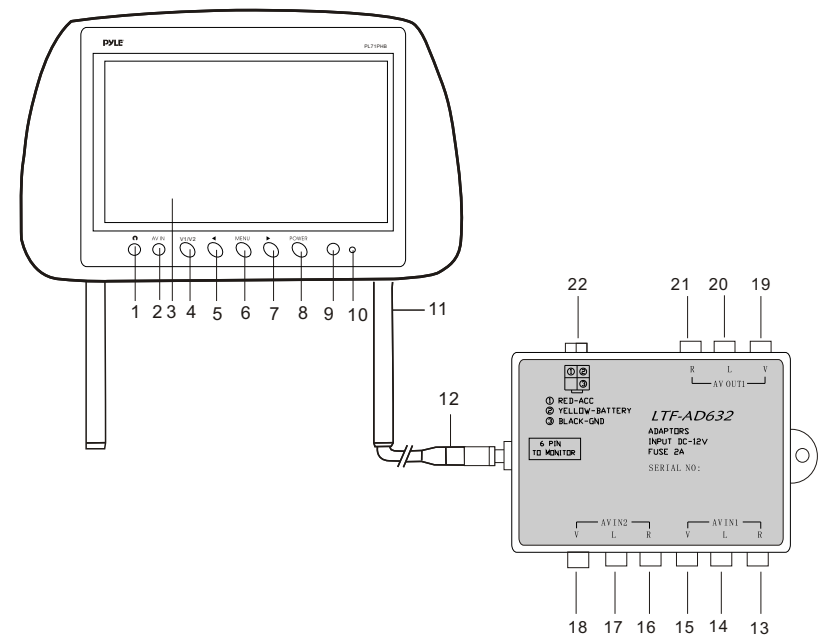

- 1. Audio out(headphones)
- 2. Audio/video in
- 3. Color LCD Screen
- 4. V1/V2 (Video1, Video2)
- 5. Reduce Button
- 6. Menu(brightness. Color.contrast)buttons
- 7. Increase Button
- 8. Power on/off
- 9. Remote controller receiver
- 10. Power indicator light
- 11. Removable tube spacer
- 12. Monitor Connector

- 13. AV1 Audio right input
- 14. AV1 Audio left input
- 15. AV1 Video input
- 16. AV2 Audio right input
- 17. AV2 Audio left input
- 18. AV2 Video input
- 19. Video output
- 20. Audio left output
- 21. Audio right output
- 22. 12V power input

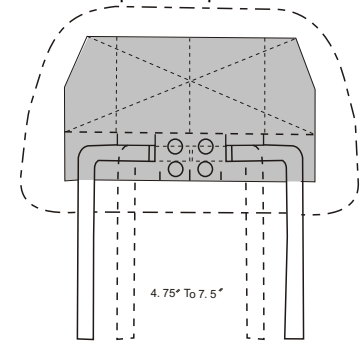

You may adjust the stainless steel by adjusting the tube until the headrest indicator can fit on the back seat (Maximum adjustment width is 7CM)

AV Display Mode:

Operating method: Press the button "AV1/AV2" on the remote control unit to choose AV display mode. If the VCD or DVD signal is connected, there should be display normally pictures signal ;If the VCD or DVD signal isn't connected, AV character should be appear top the left corner and the screen is blue.. the system will display "NO SIGNAL".

1. BRIGHTNESS
2. COLOR
3. CONTRAST
4. TINT(only NTSC system)
5. LANGUAGE
6. SCALING (16:9/4:3)

The above functions can be executed by MENU on the display or remote control unit.

1. Brightness: Press the MENU button on the display or MENU on the remote control unit, then press: "◀" "▶" button on the display or "▲" "▼" keys on the remote control unit to choose what you need.
2. COLOR: Press the MENU button on the display or MENU on the remote control unit thrice , then press: "◀" "▶" button on the display or "▲" "▼" keys on the remote control unit to choose what you need.
3. Contrast Ratio: Press the MENU button on the display or MENU on the remote control unit twice, then press: "◀" "▶" button on the display or "▲" "▼" keys on the remote control unit to choose what you need.
4. TINT: Press the MENU button on the display or MENU on the remote control unit four times , then press: "◀" "▶" button on the display or "▲" "▼" keys on the remote control unit to choose what you need0
5. Language : please press the manual of unit or the remote control six times, then press "◀" "▶" on the unit or "▲" "▼" on the remote control to select you need..
6. scaling: Press the MENU button on the display five times , then press: "▶" "◀" button on the display to choose .

Remote Control

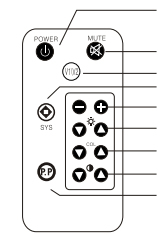

- 1.power: switch on/off power
- 2.mute: press this button,the sound disappear.
- 3.V1/V2: V1/V2 switch
- 4.Reverse:Turn the picture from left to right or up to down.
- 5.vol+/-:Press them to increase and decrease the volume.
- 6.☉+/-:Press them to increase and decrease the brightness.
- 7.col+/-:press them to increase and decrease the color.
- 8.⦿ Press them the increase and decrease contrast.
- 9.⦿ Mode: press it to select the mode (standard, brightness, soft, Vividness.self-defined.)

Replacing the battery

- 1 Insert your finger nails into A and B on the diagram below, press A according to the direction, then pull out the battery holder.
- 3 Fit the battery holder back to its place.

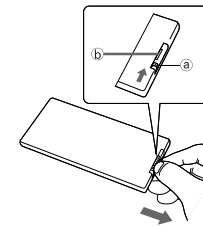

- 2 Remove the old battery, then insert the new battery into the battery holder with the + side facing upwards.

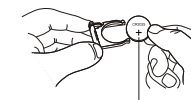

Lithium battery (Cr2025)

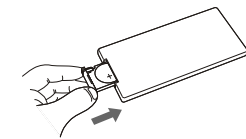

Note:

To prevent leakage of fluid from the lithium battery, remove the battery when not using the remote control unit for long periods of time (one month or more). If the battery leaks fluid, carefully wipe it out of the battery case, then change to a new lithium battery.

6. SIMPLE TROUBLE-SHOOTING GUIDE

Below symptom no mean this production have been broken, Please check before you repair !

Symptom	Probable Cause	Solution
Black Screen	<ol style="list-style-type: none"> 1.No12 voltage 2.Brightness or contrast ratio is too small 3.no high-voltage 	<ol style="list-style-type: none"> 1 .check the power is on or connect rightly 2. check the A/V Cable is loose or not 3. Increase the brightness and contrast ratio
NO picture	<ol style="list-style-type: none"> 1.No sources output 2.The video concentric plug becomes loose 	<ol style="list-style-type: none"> 1.Check the output of VCD or DVD 2.Replace with the A/Vcable 3.Tighten the Video input cable
color picture	<ol style="list-style-type: none"> 1 Video sources have no output 2.Color ratio should be re-adjust 	<ol style="list-style-type: none"> 1.check the video sources 2.Enter into the Menu to re-adjust
With a little regular light spots and color spots on the screen or black horizontal line in the picture	It is normal symptom in the active matrix display technology.	it is normal symptom in view range with a little regular light spots on display screen.
Unclear picture	<ol style="list-style-type: none"> 1.Poor quality of the video sources 2.Bright & Contrast 	<ol style="list-style-type: none"> 1.Replace with the high quality videodisc 2.Reset Bright & contrast.
The outer cover of the monitor has been deformed	<ol style="list-style-type: none"> 1.External temperature is too high 2. The power has not been switch off for a long time 	<ol style="list-style-type: none"> 1.The surround temperature could not exceed to 0° -60° 2.Turn off the power after using the unit