

SP35 Printer Guide

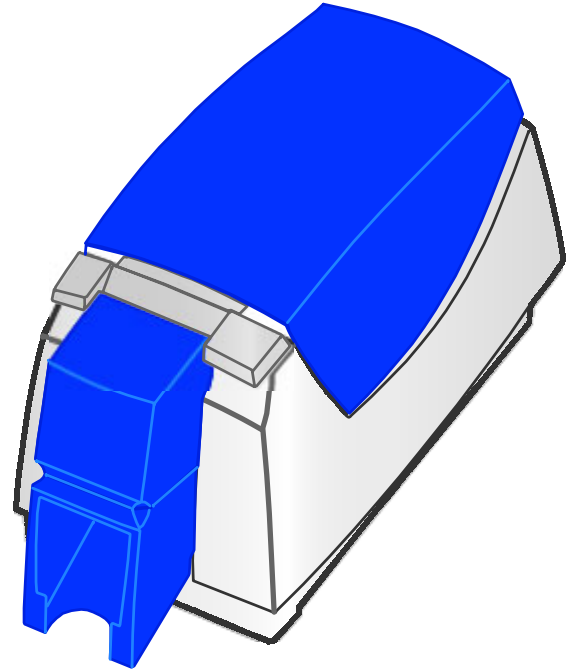



553772-001

May 2003

Datacard[®]

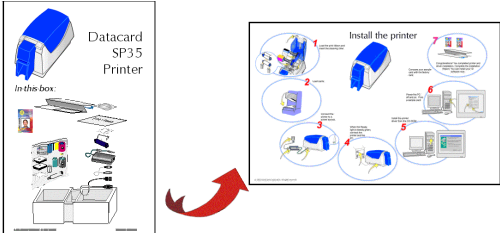

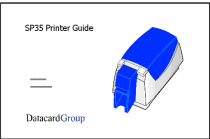
Information resources for the SP35 Printer

Installation	<p>To install the printer:</p> <p>To install one printer to a PC using a USB cable, see the Installation Map, shipped at the top of the printer carton.</p> <p>For detailed installation information or for special situations (such as network installation), see e-Guide/SP Series/SP_Info_Central.chm on the driver CD-ROM.</p>	 The image shows the Datacard SP35 Printer box on the left, labeled 'Datacard SP35 Printer' and 'In the box'. To the right is a diagram titled 'Install the printer' with seven numbered steps (1-7) illustrating the installation process. A red arrow points from the printer box towards the installation map.
Message Help	<p>If you see a message, click Help on the message box. Really! Help topics are short and to the point.</p>	 A screenshot of a Windows dialog box titled 'SmartDriver (Copy 2)'. The message reads: 'A card was not picked successfully. (IS-01206) Click Help for steps to follow.' There are three buttons: 'Retry', 'Cancel', and 'Help'.
Printer Guide	<p>This Printer Guide contains operating information for the printer and driver.</p>	 An icon for the 'SP35 Printer Guide' showing a blue printer and the 'DatacardGroup' logo.
<i>SP35 Info Central</i>	<p>For in-depth information about using the printer or driver, click the <i>SP35 Info Central</i> icon on the desktop. (Insert the CD-ROM and choose User Information to install Info Central if the icon is not on the desktop.)</p>	 An icon for 'SP35 Info Central' showing a blue printer and a CD-ROM.
FAQs	<p>Service and Support FAQs at www.datacard.com provide answers to questions about the SP35 printer.</p>	
Dealer	<p>For help with questions not addressed by other SP35 information, contact your dealer.</p>	
Customer Care	<p>Contact the Datacard Customer Care Center at 1.800.328.3996 (U.S. & Canada) or 1.952.988.2316 (worldwide).</p>	

Contents

About the printer	1
Loading cards	5
Loading print ribbon	7
Check the PC connection	9
Status light	11
Opening Properties or Printing Preferences . .	13
Open the Printer Toolbox	15
Cleaning the printer	17
Printer supplies	19
Getting the most out of your printer	21
Troubleshooting	23
Site requirements	25
Legal Notices (FCC)	26

About the printer

The outside of the printer

Printer Cover.

Latch: Lift the latch to open the printer cover.

Card Tray: Lift the cover to load blank cards.

Card output tray: Remove completed cards.

Ready button: Push to pause or unpause the printer

The status light helps you understand printer operation. See “Status light” on page 11 for details.

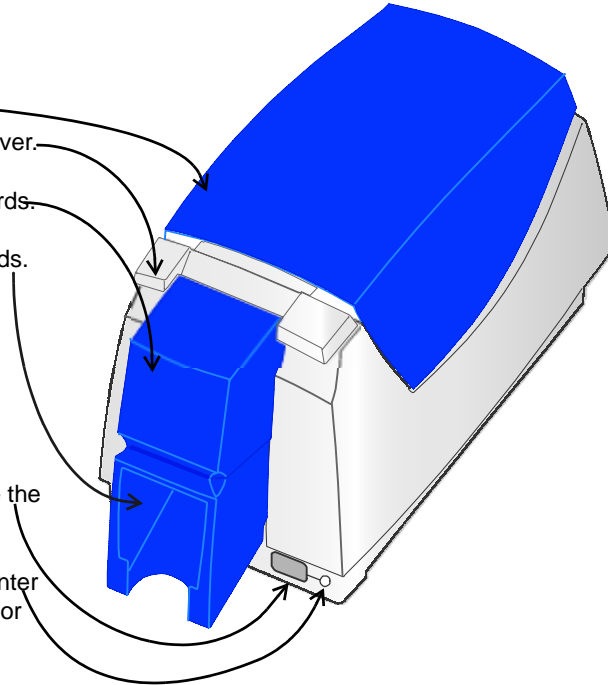

Ports are located on the left side of the printer.

Manual Advance Knob: Use to release a card in the printer or to turn rollers.

Power Receptacle: Plug in the power supply to power on the printer.

Cable Guides: Hold the data cable securely.

Optional Smart Card USB Port: See "Features and options" on page 4.

Optional Smart Card Serial Port: See "Features and options" on page 4.

USB Data Port: Connect the data cable to the printer. *ALL* printers use this port.

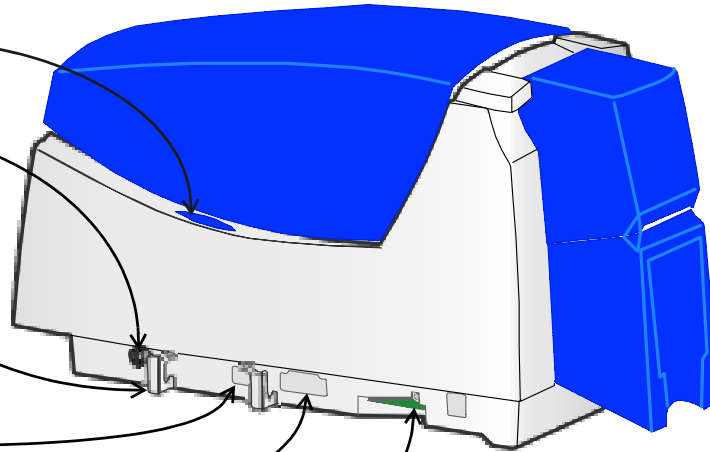

The inside of the printer

Cover Arm: Holds the cover and printhead cartridge in place.

Printhead Cartridge: Applies the image to the card. The label includes "YMC" for color or "K" for monochrome printheads.

Print ribbon cartridge with print ribbon.

Printer Label: Includes the serial number and model information (located on the left side of the printer and not visible in this drawing).

Cleaning roller (not visible in this drawing): Removes dust and debris from cards.

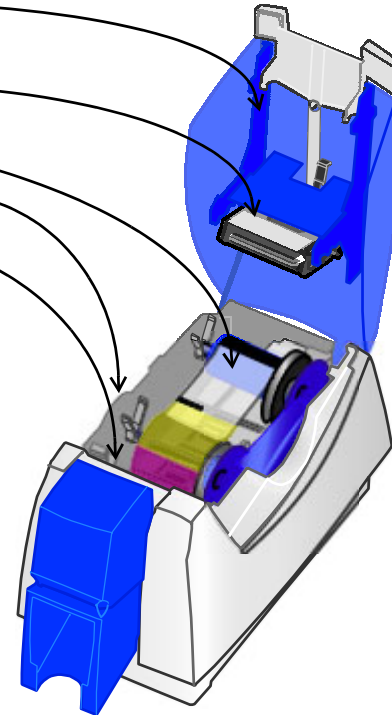
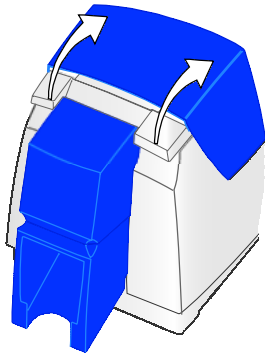

Tip: Lift the latch to open the printer and see inside.

Features and options

Features and options are identified on the printer label.

- Printers with “K” **printing** can print one color (monochrome). “C” printing is full-color printing.
- All SP35 printers use a USB **connection**.
- A **magnetic stripe** module can be a three-track (IAT) or single-track (NTT or J) module. The optional magnetic stripe module is visible inside the printer.
- An optional **smart card** module can be one of the following:
 - Contact coupler (SC430 on the label): Visible inside the printer. Includes a USB port on the printer.
 - Contactless (RF) coupler (SC680): Includes a serial port.
 - Contact station (SCCS): Visible inside the printer. Includes a serial port.
 - Combination smart card coupler (SC4/6): 430 and 680 couplers. Visible inside the printer. Includes USB and serial ports.

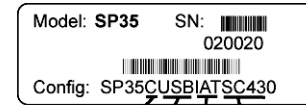
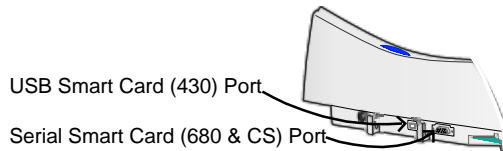

Printing: C or K
Connection: USB
Magnetic Stripe: IAT or J
Smart Card: SC430, SC680, SCCS, or SC4/6

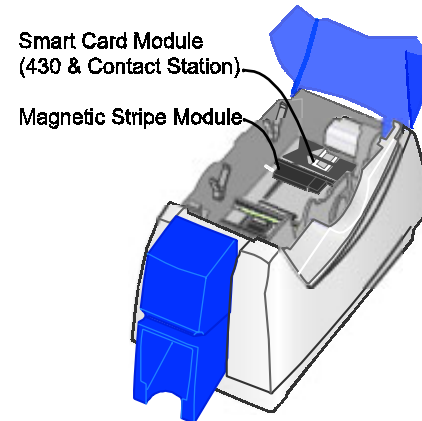

Loading cards

- 1 Lift the card tray door until it rests open.
- 2 Remove cards from the original package.

Tips: Handling cards

Do not touch the surface of cards before printing them. (Oils on hands will reduce printing quality.)

Handle cards by the edges or wear gloves.

Cards can stick together: Slide or fan cards to separate the edges.

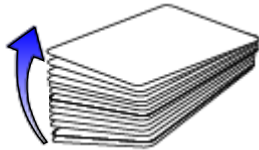

Orient all unprinted cards the same way.

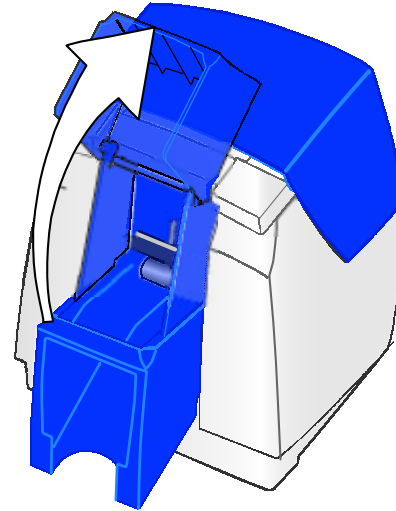

- 3** Place the cards in the card tray.
The diagram shows the typical locations for the magnetic stripe and smart card chip.
- 4** Close the card tray door. Push the door closed to align cards.

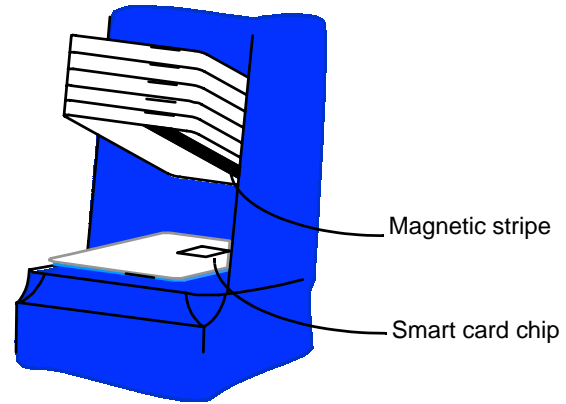

See *SP35 Info Central* for information about cards to use in the printer.

Loading print ribbon

- 1 Open the printer.
- 2 Remove the ribbon cartridge with the used ribbon.
- 3 Remove both used ribbon spools from the cartridge.

Tips: Handling print ribbon

Keep unused ribbon in the original package.

Don't place ribbon on a dusty or dirty surface—dirt could damage the printhead.

- 4 Run a cleaning card and replace the cleaning sleeve at the same time that you load a new print ribbon. See “Cleaning the printer” on page 17 for the steps to follow.
- 5 Load the new roll of print ribbon on the cartridge.
 - Put the full spool of ribbon on the supply spindle of the ribbon cartridge. Push until the spool clicks onto the spindle.
 - Put the empty take-up spool on the spindle with the solid black gear. Push until the spool clicks onto the spindle.

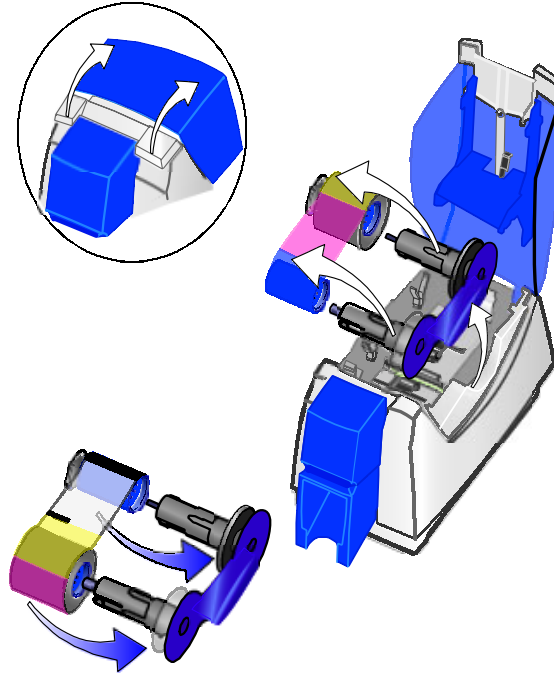

- 6** Replace the loaded ribbon cartridge in the printer.
- Make sure both spindles rest in the black supports on the left side of the printer.
 - Make sure the ribbon cartridge handle rests in the supports on the right side of the printer.
 - Make sure to install the full, new spool toward the card tray of the printer.
- 7** Close the printer cover. Press down firmly to latch it.

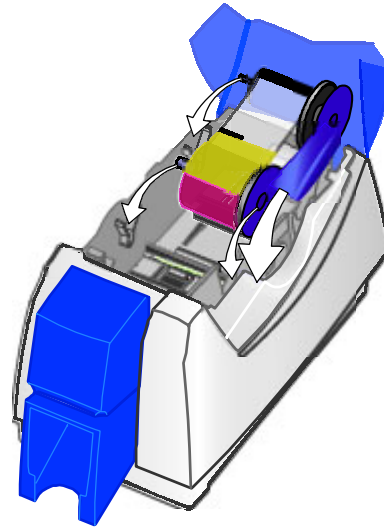
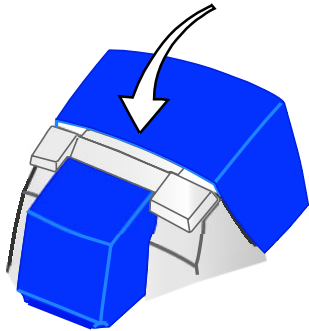

Check the PC connection

The printer and PC are connected when the printer is set up. Before beginning card processing, make sure the connection is complete.

The USB data cable should be connected to a USB port on the PC and to the USB data port on the printer.

The printer can be connected in these other ways:

Through a direct network connection, where the printer is connected to a network (using a print server) and the PC is connected to the same network.

As a shared printer, where the printer is connected to another PC on the network and the user's PC is connected to the network.

See *SP35 Info Central* for more information about connecting the printer.

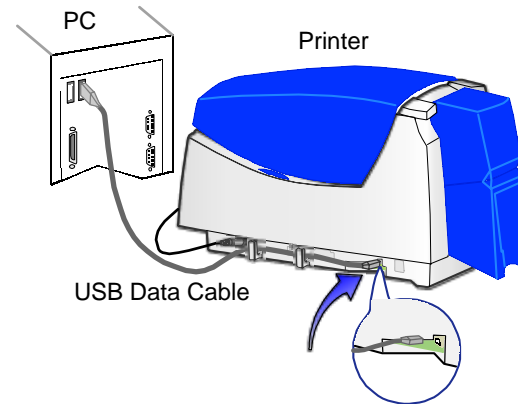

Power on the printer

Plug in the printer to power it on.

The printer does not have a power switch.

- 1 Make sure the power supply cord connects to the printer power receptacle (1).
- 2 Connect the power cord to the power supply (2).
- 3 Connect the power cord to the power outlet (3).
- 4 The printer powers on and initializes.

Tips for printer power

Wait while the printer initializes.

The printer Status Light displays steady green when the printer is ready to print cards. See "Status light" for details.



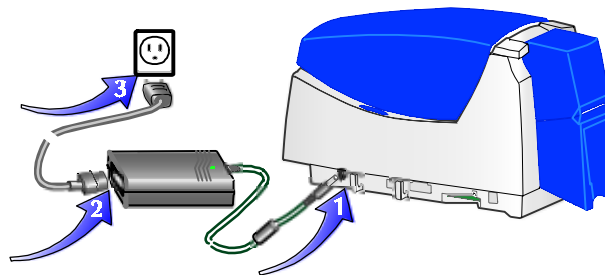

Follow the guidelines for your location to power the printer on and off.





Status light

The front of the printer has a light that provides information about the current state of the printer.

At startup, the status light displays steady amber for several seconds, the red-amber-green sequence, and blinking green for several seconds. When the printer is ready to print, the status light is steady green.

Status Light	Description	Meaning
	Red-Amber-Green	The printer is starting. The light displays colors while the printer initializes.
	Steady Green	The printer is ready and waiting to print cards.
	Blinking Green	The printer is busy, such as when printing cards or initializing.
	Steady Amber	The printer is paused (without an error) or is initializing.

Status Light	Description	Meaning
	Blinking Amber	The printer has an error. Check the following: <ul style="list-style-type: none">• See the PC for a message.• If you used the Power-on/Ready sequence to print a test card, check the printer for problems.• If you changed the printer name, power the PC off and on.
	Steady Red	The printer has a problem that requires service or the printer had a power-on problem. Power the printer off and on before calling for service.
	Off	The printer power is off.

Opening Properties or Printing Preferences

Begin with the printer connected to the PC and powered on so values are saved correctly.

- 1 Choose Start from the Windows task bar.
- 2 Choose Settings and then Printers (and Faxes). The Printers (and Faxes) window opens.
- 3 Click once on the SmartDriver printer icon to select it.
 - The driver must be installed for the printer icon to be present.
 - SmartDriver is the default name of the printer. The name of your printer might be different.
- 4 From the menu bar, choose File and then one of the following:
 - For Windows Me or 98, choose Properties.
 - For Windows 2000 or XP, choose Printing Preferences, and then click the Advanced button.

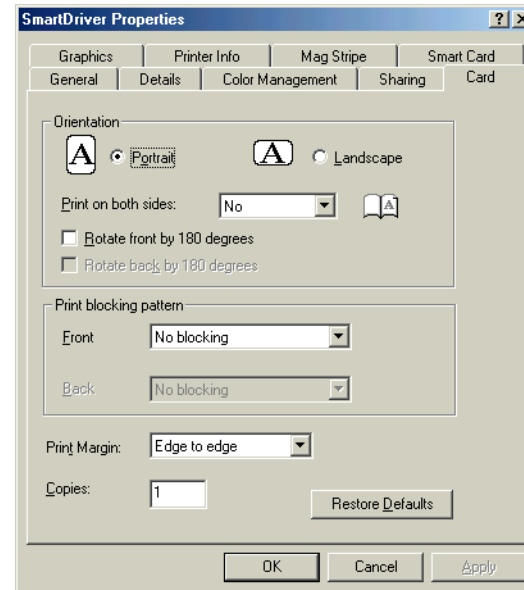

Properties dialog box for Windows 98 SE and Windows Me

- 5 The dialog box opens.
- 6 View settings or change settings.
 - Make sure that driver settings match printer features and supplies used.
 - The Print Ribbon Type setting depends on the printer and cannot be changed.
 - If you change the card design, review and update all settings for the new card design.
 - Use the default settings of “Spool printing so program finishes printing faster.” and “Enable bi-directional support.”
- 7 Choose OK to save and close or choose Cancel to close without saving changes.

See *SP35 Info Central* for detailed setup information, including information about settings for card features.

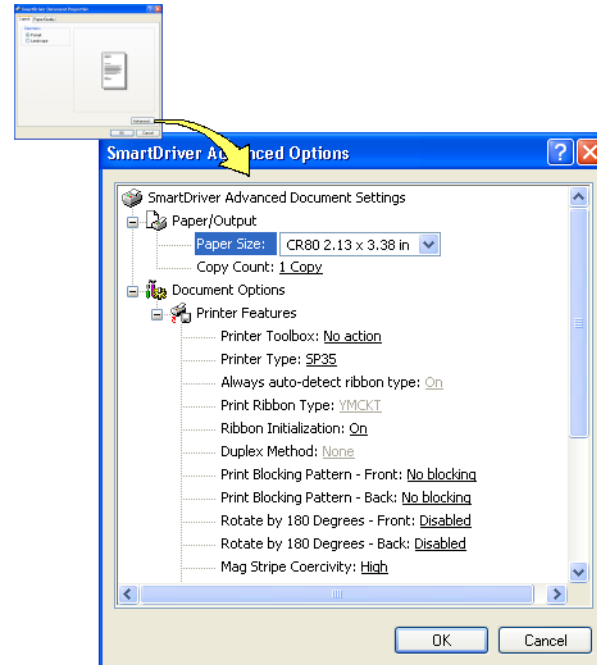

Printing Preferences dialog box for Windows 2000 and Windows XP

Open the Printer Toolbox

The Printer Toolbox icon is located in the lower right corner of the Windows desktop. The icon shows the status of communication between the printer and driver. See *SP35 Info Central* for details about the icon.

By default, the Printer Toolbox dialog box is displayed. If it is not, do one of the following to display it:

- Double-click the icon.
- Open the Properties or Printing Preferences dialog, and click Printer Toolbox.

Use the Printer Toolbox to:

- Run a cleaning card
- Use color settings
- Print a sample card or magnetic stripe card
- View the status of communication between printer and driver
- Suspend communication when not printing a card
- Start or quit advanced setup to change the position of printing or printing intensity

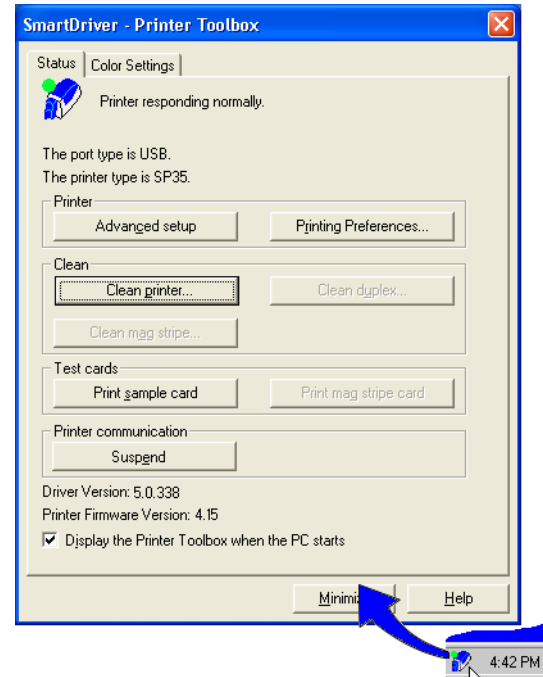

The Printer Toolbox displays:

- The current state of communication between the driver and printer.
- Message text, if there are any messages.
- The current port mode, which can be USB, Shared Mode, or Directly Networked.
- The printer type.
- The driver and printer firmware version numbers.

Communication automatically resumes when you print a card, or when you open the Properties or Printing Preferences dialog box.

Buttons on the Printer Toolbox are grayed out when a card is ready to print or is printing, when there is a message, or when the printer is powered off. Fix the problem or wait until printing is done before printing a sample card, running a cleaning card, or using advanced setup.

See *SP35 Info Central* for more information about the Printer Toolbox.

Cleaning the printer

Run a cleaning card and change the cleaning sleeve when changing the print ribbon.

- 1 Open the printer cover and remove the ribbon cartridge.
- 2 Remove the replaceable cleaning roller.
- 3 Open the card tray door (1).
- 4 Remove unprinted cards from the card tray (2).
- 5 Open the Printer Toolbox (if needed, see page 15). Make sure that all cards are printed so the Clean Printer button is enabled.
- 6 Click the Clean Printer button. A prompt to insert the cleaning card appears.
- 7 Open the cleaning card package and remove the cleaning card.

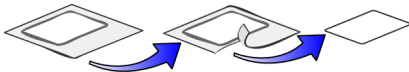

- 8 Place the cleaning card in the card tray (3).
- 9 Click OK on the message box. The printer moves the card through the printer several times and then ejects the card.

Clean Printer button

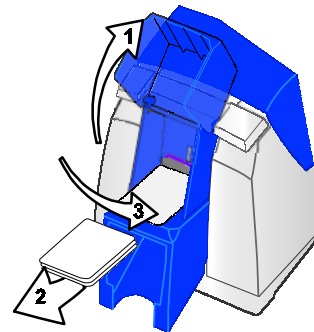
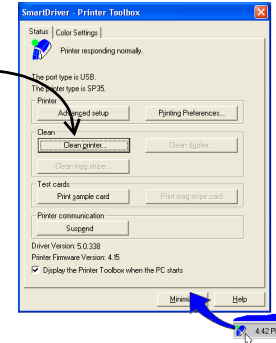

- 10** Slide the used cleaning sleeve off the spindle.
- 11** Place a new cleaning sleeve on the spindle (1).
- 12** Remove the protective cover from the sleeve (2).
- 13** Insert the replaceable cleaning roller (with a new cleaning sleeve) into the printer (3).
- 14** Replace the ribbon cartridge, close the printer cover, and resume printing.
- 15** Discard the used cleaning card and used sleeve.

Cleaning tips

Use the cleaning card as soon as you open the package. The cleaning solution on the card evaporates after a few minutes.

Some card features, such as signature panels and magnetic stripes, can require more frequent cleaning of the printer.

Clean printer rollers regularly, such as every time you change the ribbon. See *SP35 Info Central* for details.

If you use StickICards™, clean the card tracks after every 100 cards. Use the cleaning pen to reach most areas of the card track. Use isopropanol and a swab (not included in the cleaning kit) to reach hidden areas of the card track.

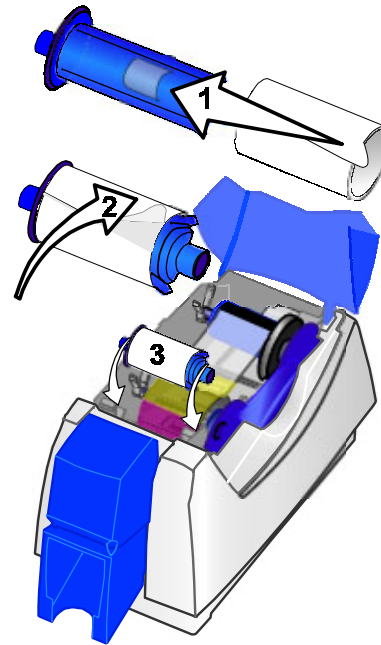

Printer supplies

Ribbon kits and cleaning supplies are available for the printer.

Ribbon kits contain a roll of print ribbon, a cleaning card, and a replaceable cleaning sleeve. Datacard recommends that you run a cleaning card and replace the cleaning sleeve each time you change the print ribbon.

Color print ribbon

Color print ribbon is available as part of the YMCKT Color Ribbon Kit, part number 552854-504. A roll of ribbon prints up to 500 images.

YMCKT has color (Y=yellow, M=magenta, C=cyan/blue) panels, a K (black) panel, and a T (topcoat) panel. Datacard color print ribbon for SP series printers uses Advanced Imaging Technology™.

Monochrome and Topcoat ribbon

Ribbon with alternating Monochrome (K) and Topcoat (T) panels is available as part of the KT Color Ribbon Kit, part number 552854-509. A roll of ribbon prints up to 1000 images.

Monochrome print ribbon

Several colors of monochrome (single-color) print ribbon are available for the SP35 printer. A roll of ribbon prints up to 1500 images (if ribbon-saver is not used).

Available colors include:

Color	Part number
Black	552954-501
Dark Blue	552954-502
White	552954-503
Red	552954-504
Silver	552954-507
Scratch-off	552954-513

Cleaning supplies

Datacard recommends that you order additional cleaning supplies to have on hand to address unusual situations.

A package of 5 replaceable cleaning sleeves is available. The part number is 549716-002.

A package of 10 cleaning cards is available. The part number is 552141-002.

See the Supplies section of *SP35 Info Central* for complete information about supplies and replacement parts for the SP35 printer.

Getting the most out of your printer

To get the best quality cards and to maintain printer performance, follow these tips for success:

- Use the best quality cards available with a smooth, glossy PVC surface and print them only once. Make sure options, such as a mylar signature panel or a magnetic stripe, are high quality.
- Match the card design and the supplies you use to obtain the results you want.
 - Edge to edge printing requires high-quality cards and can require fine-tuning the printer and the card design.
 - Avoid placing an image or important data on the other side of the card from a magnetic stripe, smart card chip, or signature panel.
 - Locate bar codes at least 0.25 inches from other printing and from the edge of the card. Make sure the color used to print the bar code works in your bar code readers.
 - Do not print closer than 0.1 inch from a signature panel, magnetic stripe, or smart card chip.

- Do not apply topcoat over a magnetic stripe, signature panel, or smart card chip.
- Follow instructions carefully when replacing supplies, correcting problems, cleaning the printer, and replacing parts.
- Use the correct cables and connect them correctly.
- Keep supplies on hand and store them safely.
- Keep the printer clean and keep the area around the printer clean.

See *SP35 Info Central* for detailed information about:

- Setting up the printer for the card design
- Making cards
- Troubleshooting
- Supplies

Troubleshooting

What is the problem?

- 1 A message appeared on the PC.
- 2 The printed cards do not look the way that I want them to.
- 3 Cards jam often.
- 4 The ribbon has broken.

Try this:

- Click the Help button on the message box. The help topic describes possible causes and the solution for each cause. Follow the information in help to fix the problem.
 - You might have moved the ribbon while the printer was powered off. The next card will print correctly.
 - *SP35 Info Central* contains detailed information about solving card appearance problems.
 - The brand of cards might be dirty, heavily powdered, or bowed (curved). Consider buying a different brand of cards or clean the printer more often to use the cards.
 - The printer rollers might be dirty. See *SP35 Info Central* for steps to clean the printer rollers.
 - Trim the end of the broken ribbon evenly. If ribbon on the take-up spool is not wound firmly or is uneven, remove it. Tape the end of the ribbon onto the *same* take-up spool, making the edges of the ribbon and spool even.
 - If the ribbon breaks repeatedly, settings might not be correct for the card design and ribbon. See Setup in *SP35 Info Central*.
-

What is the problem?**Try this:**

- 5** The printer does not respond when I print a card or when I click “Resume” on the Printer Toolbox.
- Make sure the printer is plugged in. See “Power on the printer” on page 10.
 - Make sure the printer is connected to the PC. See “Check the PC connection” on page 9.
 - If the Status Light on the printer is blinking amber (orange), press the Ready button for 5-7 seconds.
 - Power off the printer and power it on to see if communication resumes.
 - See *SP35 Info Central* for more detailed communication troubleshooting information.
- 6** The printer cover will not close.
- Push firmly on the front edge of the blue cover to latch it.
 - Make sure no extra items are inside the printer.
 - Make sure the print ribbon cartridge is installed correctly. See “Loading print ribbon” on page 7.
 - If you installed or bumped the printhead cartridge, make sure it is installed correctly. See *SP35 Info Central*.
-

Site requirements

Operating environment

- Relative humidity: 20% to 80% non-condensing
- Temperature: 60° F to 95° F (15° C to 35° C)

Electrical requirements

- The power supply is rated at 100-240 VAC, 50-60 Hz, 1.0 amp. (The power supply adjusts to any power within this range.)
- Single phase, 3-wire, grounded receptacle only.

Physical requirements

- The printer weighs less than 9 pounds (4 kg). The weight depends on the options installed.
- Printer dimensions are 16.5 inches (419 mm) long, 7.8 inches (198 mm) wide, and 9 inches (229 mm) high.
- The clearance required 1 inch (2.5 cm) at the back, 2 inches (5 cm) on the left side, and 10.5 inches (26.7 cm) above the printer to open the cover.

Do not use the printer in a dirty environment. Do not use the printer in a closed compartment. Do not block air flow around the printer.

Legal Notices (FCC)

Please note and heed the WARNING and CAUTION labels that have been placed on the equipment for your safety. Please do not attempt to operate or repair this equipment without adequate training.

Liability statement

This Datacard® product has been built to the high standards of DataCard Corporation. See *SP35 Info Central* for the statement of liability.

Regulatory compliance

This Datacard product conforms to FCC and regulatory requirements as specified in North America and Europe. See *SP35 Info Central* for detailed regulatory compliance information.

Trademark acknowledgments

Trademark, service mark, and copyright acknowledgments are listed in *SP35 Info Central*.

Proprietary Notice

All drawings and information herein are the property of DataCard Corporation.

Datacard Group

11111 Bren Road West
Minnetonka, MN 55343-9015
952.933.1223
952.933.7971 FAX
www.datacard.com

Dealer information:

Datacard is a registered trademark of DataCard Corporation.

May 2003

553772-001