



USER MANUAL

ProLite

LCD Monitor

ENGLISH

ProLite L403W

ProLite L323W

Thank you very much for choosing the iiyama LCD monitor. We recommend that you take a few minutes to read carefully through this brief but comprehensive manual before installing and switching on the monitor. Please keep this manual in a safe place for your future reference.

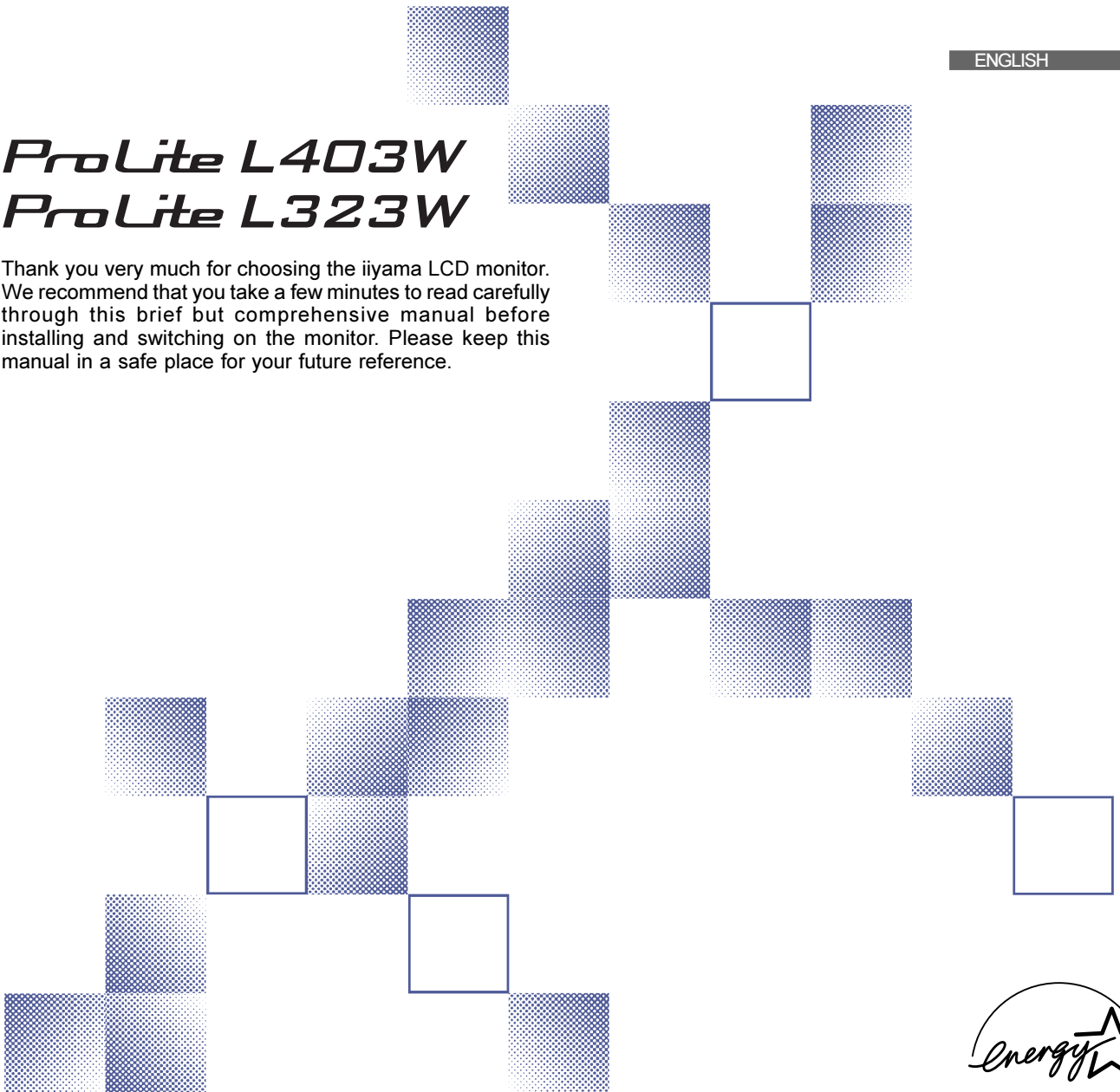

FCC DECLARATION OF CONFORMITY

Model Number: PLL403W / PLL323W
Trade Name: iiyama
Responsible party: IIYAMA North America, Inc.
Address: 65 West Street Road, Suite 101B, Warminster, PA18974 U.S.A.
Telephone number: 215-682-9050

This device complies with Part 15 of the FCC Rules. Operation is subject to the following two conditions: (1) This device may not cause harmful interference, and (2) this device must accept any interference received, including interference that may cause undesired operation.

This device has been tested and found to comply with the limits for Class B Personal Computers and peripherals, pursuant to Part 15 of the FCC Rules. These limits are designed to provide reasonable protection against harmful interference when the device is operated in a residential environment. This device generates, uses and can radiate radio frequency energy, and if not installed and used in accordance with the instructions, may cause harmful interference to radio communications. However, there is no guarantee that interference will not occur in a particular installation. If you determine the device does cause harmful interference to radio or television reception (this may be determined by monitoring the interference while turning the device off and on), you are encouraged to try to correct the interference by one of the following measures:

- Reorient or relocate the receiving antenna.
- Increase the separation between the device and receiver.
- Connect the device into an outlet on a circuit different from that to which the receiver is connected.
- Consult the dealer or an experienced radio or TV technician for help.

To meet the FCC requirements, you should use a signal cable with ferrite core at both ends.

CAUTION

Changes or modifications not expressly approved by iiyama could void the users authority to operate the device under FCC compliance regulations.

CANADIAN DEPARTMENT OF COMMUNICATIONS COMPLIANCE STATEMENT

This digital apparatus does not exceed the Class B limits for radio noise emissions from digital apparatus as set out in the radio interference regulation of the Canadian department of communications.

CE MARKING DECLARATION OF CONFORMITY

This LCD monitor complies with the requirements of the EC Directive 89/336/EEC "EMC Directive" and 73/23/EEC "Low Voltage Directive" as amended by Directive 93/68/EEC.

The electro-magnetic susceptibility has been chosen at a level that gives correct operation in residential areas, business and light industrial premises and small-scale enterprises, inside as well as outside of the buildings. All places of operation are characterised by their connection to the public low voltage power supply system.

TABLE OF CONTENTS

FOR YOUR SAFETY	1	OPERATING THE MONITOR	8
SAFETY PRECAUTIONS	1	ADJUSTMENT MENU CONTENTS	9
SPECIAL NOTES ON LCD MONITORS	2	SCREENADJUSTMENTS	12
CUSTOMER SERVICE	2	POWER MANAGEMENT FEATURE	13
CLEANING	2	TROUBLE SHOOTING	14
BEFORE YOU OPERATE THE MONITOR	3	APPENDIX A	15
FEATURES	3	SPECIFICATIONS	15
CHECKING THE CONTENTS OF THE PACKAGE	3	DIMENSIONS	15
OPTIONAL PARTS	3	COMPLIANT TIMING	16
TO AID STABILITY	3	CONNECTOR PIN ASSIGNMENT	16
CONTROLS AND CONNECTORS	4	APPENDIX B	17
SPEAKER INSTALLATION	6	REMOTE CONTROL	17
PROCEDURE AND CONDITIONS		BASIC OPERATION	19
FOR MONITOR INSTALLATION	6	SELECTION OF TV CHANNEL	20
CONNECTING YOUR MONITOR	7	ADJUSTMENT MENU CONTENTS	21
COMPUTER SETTING	7	TELETEXT FUNCTION	25
		SPECIFICATIONS	25

- We reserve the right to change specifications without notice.
- All trademarks used in this user manual are the property of their respective owners.
- As an ENERGY STAR® Partner, iiyama has determined that this product meets the ENERGY STAR® guidelines for energy efficiency.

FOR YOUR SAFETY

SAFETY PRECAUTIONS

WARNING

STOP OPERATING THE MONITOR WHEN YOU SENSE TROUBLE

If you notice any abnormal phenomena such as smoke, strange sounds or fumes, unplug the monitor and contact your dealer or iiyama service center immediately. Further use may be dangerous and can cause fire or electric shock.

NEVER REMOVE THE CABINET

High voltage circuits are inside the monitor. Removing the cabinet may expose you to the danger of fire or electric shock.

DO NOT PUT ANY OBJECT INTO THE MONITOR

Do not put any solid objects or liquids such as water into the monitor. In case of an accident, unplug your monitor immediately and contact your dealer or iiyama service center. Using the monitor with any object inside may cause fire, electric shock or damage.

INSTALL THE MONITOR ON A FLAT, STABLE SURFACE

The monitor may cause an injury if it falls or is dropped.

DO NOT USE THE MONITOR NEAR WATER

Do not use where water may be splashed or spilled onto the monitor as it may cause fire or electric shock.

OPERATE UNDER THE SPECIFIED POWER SUPPLY

Be sure to operate the monitor only with the specified power supply. Use of an incorrect voltage will cause malfunction and may cause fire or electric shock.

PROTECT THE CABLES

Do not pull or bend the power cable and signal cable. Do not place the monitor or any other heavy objects on the cables. If damaged, the cables may cause fire or electric shock.

ADVERSE WEATHER CONDITIONS

It is advisable not to operate the monitor during a heavy thunder storm as the continual breaks in power may cause malfunction. It is also advised not to touch the plug in these circumstances as it may cause electric shock.

CAUTION

INSTALLATION LOCATION

Do not install the monitor where sudden temperature changes may occur, or in humid, dusty or smoky areas as it may cause fire, electric shock or damage. You should also avoid areas where the sun shines directly on the monitor.

DO NOT PLACE THE MONITOR IN A HAZARDOUS POSITION

The monitor may topple and cause injury if not suitably located. Please also ensure that you do not place any heavy objects on the monitor, and that all cables are routed such that children may not pull the cables and possibly cause injury.

MAINTAIN GOOD VENTILATION

Ventilation slots are provided to keep the monitor from overheating. Covering the slots may cause fire. To allow adequate air circulation, place the monitor at least 10 cm (or 4 inches) from any walls.

Ventilation slots on the back of the cabinet will be blocked and the monitor may overheat if the stand is removed. This may cause fire or damage. Operating the monitor on its back, side, upside down or on a carpet or any other soft material may also cause damage.

DISCONNECT THE CABLES WHEN YOU MOVE THE MONITOR

When you move the monitor, turn off the power switch, unplug the monitor and be sure the signal cable is disconnected. If you do not disconnect them, it may cause fire or electric shock. It is recommended that two people are used when moving the monitor.

UNPLUG THE MONITOR

If the monitor is not in use for a long period of time it is recommended that it is left unplugged to avoid accidents.

HOLD THE PLUG WHEN DISCONNECTING

To disconnect the power cable or signal cable, always pull it by the plug. Never pull on the cable itself as this may cause fire or electric shock.

DO NOT TOUCH THE PLUG WITH WET HANDS

Pulling or inserting the plug with wet hands may cause electric shock.

DO NOT TURN ON AND OFF THE POWER FREQUENCY

Do not alternate between turning the power ON and OFF frequency as it may cause damage.

DO NOT PUT FLOPPY DISKS NEAR THE SPEAKERS

Magnetically recorded data such as on a floppy disk may become corrupted by the magnetic field generated by the speakers if disks are placed too near to the speakers.

OTHERS

ERGONOMIC RECOMMENDATIONS

To eliminate eye fatigue, do not operate the monitor against a bright background or in a dark room. When using the monitor over a prolonged time, a ten minute break every hour is recommended as looking at the screen continuously can cause eye strain.

SPECIAL NOTES ON LCD MONITORS

The following symptoms are normal with LCD monitors and do not indicate a problem.

NOTE

- When you first turn on the LCD monitor, the picture may not fit in the display area because of the type of computer that is used. In this case, adjust the picture position to its correct position.
- Due to the nature of the backlight, the screen may flicker during initial use. Turn off the Power Switch and then turn it on again to make sure the flicker disappears.
- You may find slightly uneven brightness on the screen depending on the desktop pattern you use.
- Due to the nature of the LCD screen, an afterimage of the previous screen may remain after switching the image, when the same image is displayed for hours. In this case, the screen is recovered slowly by changing the image or turning off the Power Switch for hours. There is the possibility that the previous screen has been fixed. Pay attention sufficient when you use LCD Monitor.
- Contact your dealer or iiyama service center for the backlight replacement when the screen is dark, flickering or not lighting up. Never attempt to replace it by yourself.

CUSTOMER SERVICE

NOTE

- The fluorescent light used in the LCD monitor may have to be periodically replaced. For the warranty coverage on this component, please check with local iiyama service center.
- If you have to return your unit for service and the original packaging has been discarded, please contact your dealer or iiyama service center for advice or replacement packaging.

CLEANING

WARNING

- If you drop any materials or liquids such as water into the monitor when cleaning, unplug the power cable immediately and contact your dealer or iiyama service center.

CAUTION

- For safety reasons, turn off the power switch and unplug the monitor before you clean it.

NOTE

- To protect the LCD panel, do not scratch or rub the screen with a hard object.
- Never use any of the following strong solvents. These will damage the cabinet and the LCD screen.

Thinner	Spray-type cleaner
Benzine	Wax
Abrasive cleaner	Acid or Alkaline solvent
- Touching the cabinet with any product made from rubber or plastic for a long time may cause degeneration or loss of paint on the cabinet.

CABINET Stains can be removed with a cloth lightly moistened with a mild detergent solvent. Then wipe the cabinet with a soft dry cloth.

LCD Periodic cleaning with a soft dry cloth is recommended.

SCREEN Don't use tissue paper etc. because these will damage the LCD screen.

BEFORE YOU OPERATE THE MONITOR

ProLite L323W: **NOTE** The top of the monitor may become hot during use.

FEATURES

- ◆ ProLite L403W: 40" Wide Screen TFT Color LCD Monitor
ProLite L323W: 32" Wide Screen TFT Color LCD Monitor
- ◆ Supports Resolutions up to 1280 × 768
- ◆ Super Wide Viewing Angle and High Brightness
- ◆ Digital Character Smoothing
- ◆ Automatic Set-up
- ◆ Plug & Play VESA DDC2B Compliant, Windows® 95/98/2000/Me/XP Compliant
- ◆ Power Management (ENERGY STAR® and VESA DPMS Compliant)
- ◆ Digital Input (DVI-I) for Clear Display
- ◆ Digital Audio Amplifier with High Quality Sound
- ◆ Separated Stereo Speakers with High Quality Sound

CHECKING THE CONTENTS OF THE PACKAGE

The following accessories are included in your package. Check to see if they are enclosed with the monitor.
If anything is missing or damaged, please contact your local iiyama dealer or regional iiyama office.

- | | |
|------------------------------------|---------------------------------|
| ■ Power Cable * | ■ DVI-A Signal Cable DV69 |
| ■ DVI-D Signal Cable DV66 | ■ Audio Cable AD27 for computer |
| ■ Speaker × 2 | ■ Bracket for Speaker × 4 |
| ■ Screw for Speaker × 8 | ■ Speaker Cable × 2 |
| ■ Cable clamp for safety cable × 2 | ■ Screw for cable clamp × 2 |
| ■ User Manual | |

CAUTION * All guarantees and warranties are void for any problems or damage caused by a power cable not supplied by iiyama.

OPTIONAL PARTS

Optional parts as below are available for your LCD monitor. Please contact your local iiyama dealer or regional iiyama office for more details.

- ProLite L403W-S / ProLite L323W-S
Tuner / Video Adapter OTA3-2PS

- ProLite L403W-B / ProLite L323W-B
Tuner / Video Adapter OTA3-2PSB

Accessories: Remote Control, AA Dry Battery × 2, User Manual

TO AID STABILITY

Fasten the LCD monitor to a wall using a cable or chain. Attach a cable or chain to the LCD monitor using accessory clamp and screw as shown in figure. Fasten the LCD monitor to a wall using a cable or chain which is sufficient to support the weight of the LCD monitor in an appropriate way.

Before moving the LCD monitor, the cable or chain should be removed.

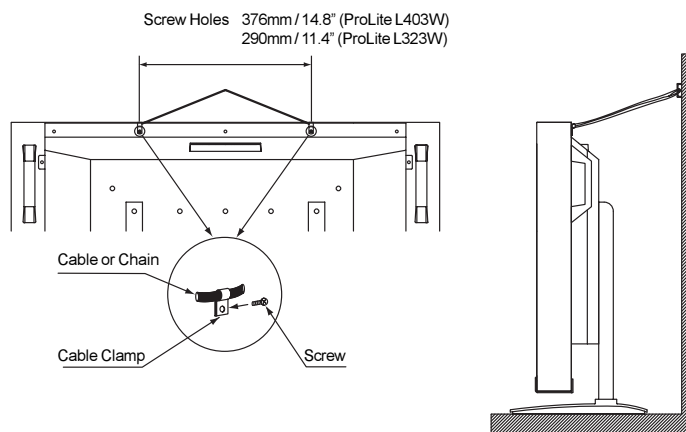

CONTROLS AND CONNECTORS

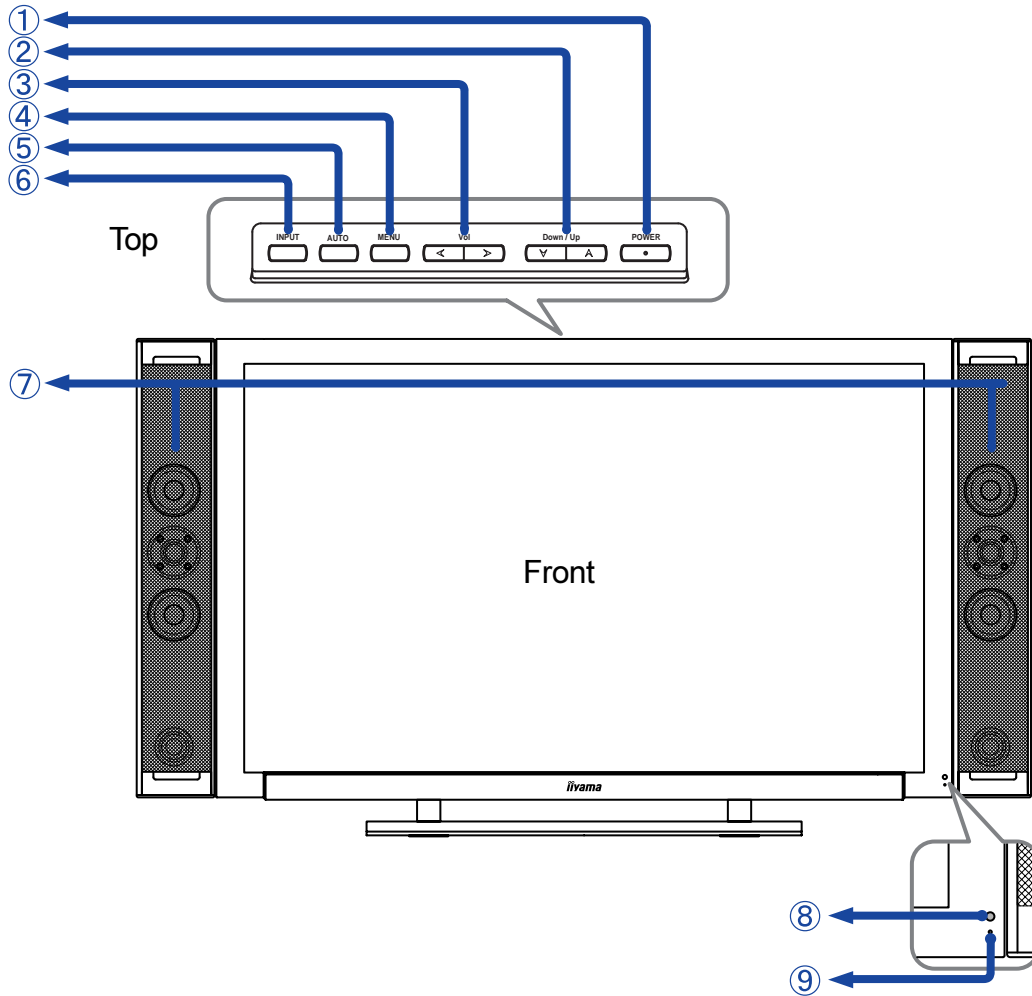

ENGLISH

Top

- ① **Power Switch**
The monitor saves the power ON / OFF setting before the Power Cable is disconnected.
If the monitor is OFF when connecting the Power Cable, press the Power Switch to turn ON the monitor. The Power Indicator turns to blue.
If the monitor is ON when connecting the Power Cable, the Power Indicator turns to blue. Press the Power Switch again to turn OFF the monitor.
- ② **Select Button (▼ / ▲)**
- ③ **Vol: Volume Control Button (◀ / ▶)**
- ④ **Menu Button**
The menu page appears or disappears on successive presses of the Menu Button.
- ⑤ **Auto Button (Auto Set-up)* / Return Button**
Adjust H Position, V Position, Clock and Phase automatically by pressing for one second or more when the menu page is not displayed.

* Available for PC Analog input only.

Auto Button / Return Button

- NOTE**
- For best results, use the Auto Set-up in conjunction with the adjustment pattern. (See page 12 for SCREEN ADJUSTMENTS.)
 - The screen becomes dark for a while during the adjustment.
 - Go back to the previous screen when the menu page is displayed on the screen.

- ⑥ **Input Button (Input Signal Select)**
Switch PC Analog or PC Digital input.

Front

- ⑦ **Speakers**
- ⑧ **Power Indicator**
NOTE Blue: Normal operation
Orange: Power Management
The monitor enters into power management mode which reduces the power consumption to less than 5W when receiving no horizontal and/or vertical sync signal.
- ⑨ **Remote Sensor**

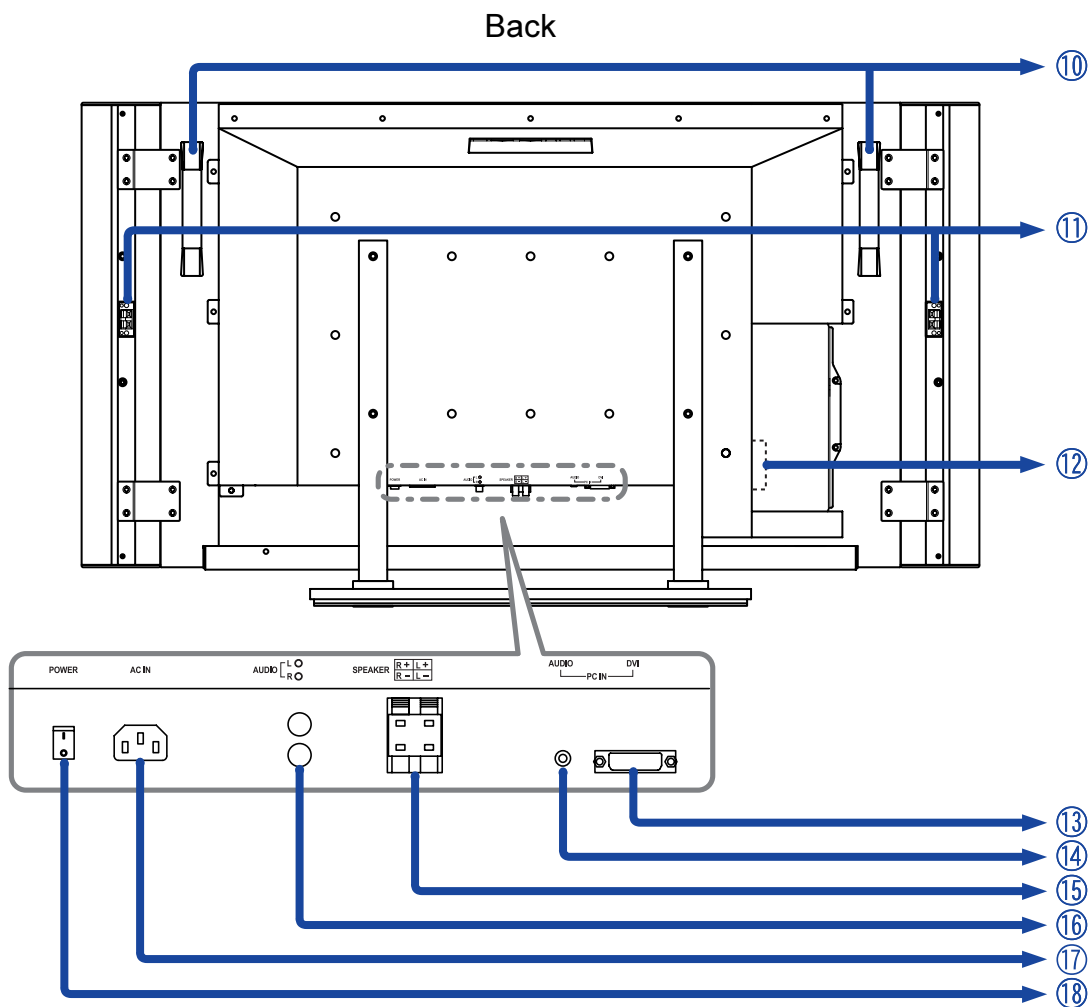

Back

- ⑩ Handles
- ⑪ Speaker Input Terminal
- ⑫ Optional Tuner / Video Adapter Slot
- ⑬ DVI-I 29pin Connector (DVI)
- ⑭ Audio Connector for computer (AUDIO)
- ⑮ External Speaker Output Terminal (SPEAKER)
- ⑯ Audio Output Connector (AUDIO R/L)
- ⑰ AC Connector (AC IN)
- ⑱ Main Power Switch (POWER)

SPEAKER INSTALLATION

CAUTION

- Turn off the power switch and unplug the monitor before installation to avoid electric shock or damage.
- The speaker is heavy. Two person handling is recommended.
- Install the speaker on a stable surface. The monitor or the speaker may cause injury or damage if they fall or are dropped.
- Do not give a strong impact to the monitor or speaker. It may cause damage.
- Do not push mesh area of speaker strongly to avoid denting it.

- ① Ensure that both the computer and the monitor are switched off.
- ② Fasten the Bracket to the Speaker with the Screws.
- ③ Fit the screw holes of the Bracket to the cavities on the back of the monitor (4 cavities for each side) and then tighten the Screws to fasten the Speaker.

NOTE Do not misplace the right and left speakers. Install the speakers with bass reflex port down.

- ④ Insert the Speaker Cable into the Speaker Input Terminal and Output Terminal.

NOTE When connect the Speaker Cable, conform the color of the Speaker Cable and Speaker Terminal. If the cables are connected incorrectly the sound quality will be reduced.

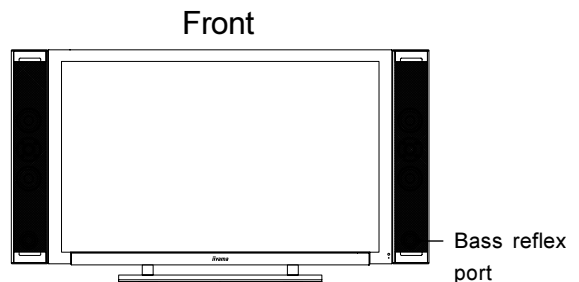
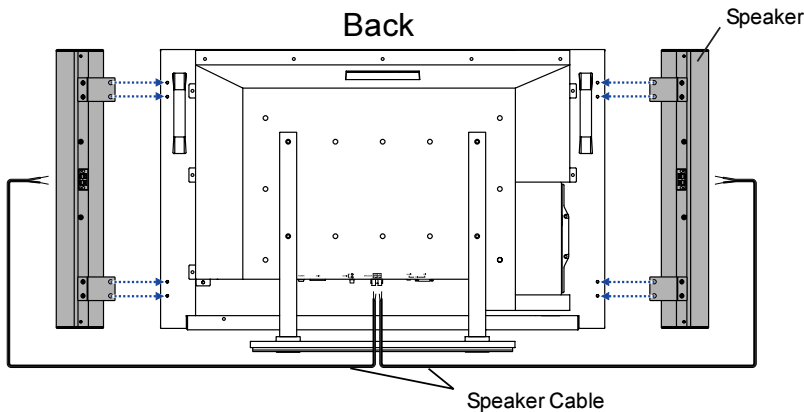
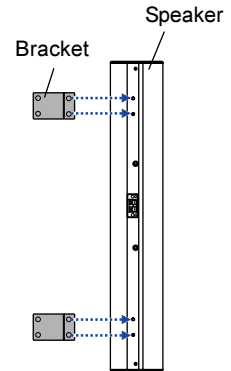

NOTE

Remove the Speaker by using the procedure above in reverse.

PROCEDURE AND CONDITIONS FOR MONITOR INSTALLATION

CAUTION

- The monitor is heavy. Two person handling is recommended.
- Do not give a strong impact to the monitor. It may cause damage.
- Unplug the monitor before installation to avoid electric shock or damage.

Follow the instructions below when installing the monitor to the wall.

- ① Environmental temperature and humidity for installation:
Please be sure that an environmental temperature and humidity DO NOT exceed the range described in the page 15 SPECIFICATIONS.

- ② Size of screw

- M6
- Length: After fasten the bracket with screws, the length of screw in the monitor should be more than 10-15mm.
- Position: more than 6 points

- ③ Recommended supportive device:

For the details of installation, see the manual of your supportive device.

Name: OBR (FFP-IN00-X)

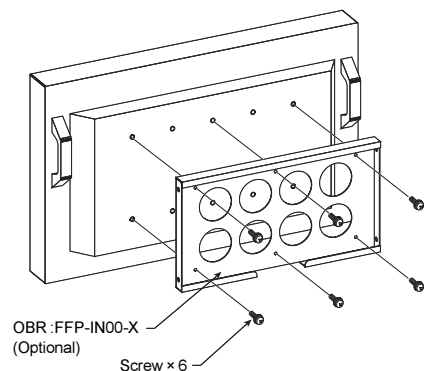

CONNECTING YOUR MONITOR

- CAUTION**
- The signal cables used for connecting the computer and monitor may vary with the type of computer used. An incorrect connection may cause serious damage to both the monitor and the computer.
 - Turn off the power switch and unplug the monitor and peripherals before connection to avoid electric shock or damage.

- ① Ensure that both the computer and the monitor are switched off.
- ② Connect the computer to the monitor with the signal cable. (See page 16 for CONNECTOR PIN ASSIGNMENT.)
- ③ Connect the monitor to the audio equipment with the Audio Cable for computer when using the audio features.
- ④ Connect the Power Cable to the monitor first and then to the power supply.

- NOTE**
- For connection to Macintosh computers, an adapter may be needed. Please contact your dealer for this.
 - Make sure you tighten the finger screws at each end of the signal cable.

[Example of Connection]

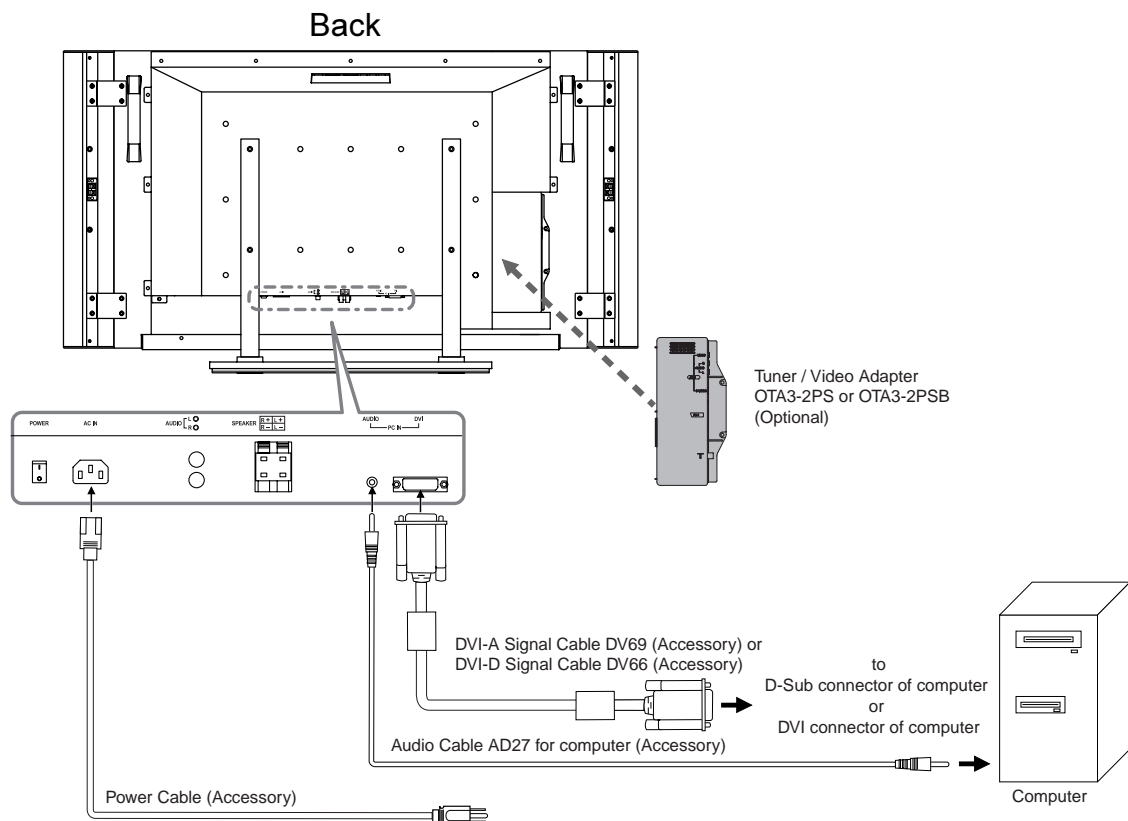

COMPUTER SETTING

- Signal Timing
Change to the desired signal timings listed on page 16 in COMPLIANT TIMING, after you confirm that the picture appears normally.

- Windows 95/98/2000/Me/XP Plug & Play

The iiyama LCD monitor complies with DDC2B of VESA standard. The Plug & Play function runs on Windows 95/98/2000/Me/XP by connecting the monitor to DDC2B compliant computer with the Signal Cable supplied. Windows 95/98/2000/Me/XP Monitor Information File for iiyama monitors may be necessary for your computer and obtained via the Internet, using the address:

<http://www.iiyama.com> (U.S.A.)

<http://www.iiyama.co.uk> (U.K.)

- NOTE**
- For additional information on how to download the driver for your monitor, please access one of the internet sites noted above.
 - Monitor Drivers are not required in most cases for Macintosh or Unix operating systems. For further information, please contact your computer dealer first for advice.

OPERATING THE MONITOR

To create the best picture, your iiyama LCD monitor has been preset at the factory with the COMPLIANT TIMING shown on page 16. You are also able to adjust the picture by following the button operation shown below. For more detailed adjustments, see page 12 for SCREEN ADJUSTMENTS.

- 1 Press the Menu Button to start the On Screen Display feature. There are additional menu pages which can be switched by using the < / > Buttons.

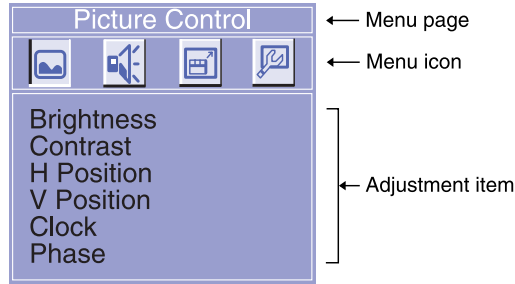

- 2 Select the menu page which contains the adjustment item you want to make. Press the Menu Button. Then, use the v / ^ Buttons to select the desired adjustment item.

- 3 Press the Menu Button again. Use the < / > Buttons to make the appropriate adjustment or setting.

- 4 Press the Auto (Return) Button to go back to the previous screen.

For example, to correct for vertical position, select menu page of "Picture Control" and then press the Menu Button. Then, select "V Position" by using the v / ^ Buttons.

An adjustment scale appears after you press the Menu Button. Use the < / > Buttons to change the vertical position settings. The vertical position of the overall display should be changing accordingly while you are doing this.

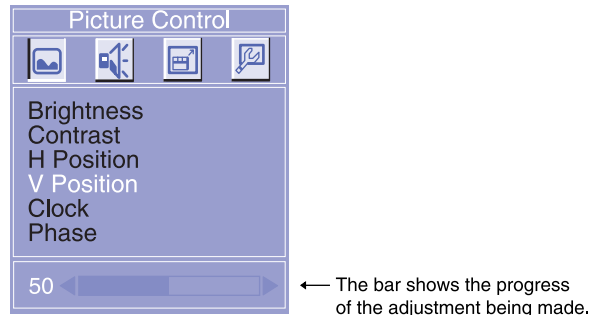









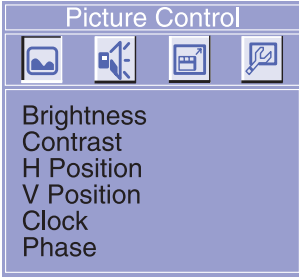







NOTE

- The On Screen Display disappears several seconds after you stop pressing the buttons while performing an adjustment.
- Any changes are automatically saved in the memory when the On Screen Display disappears. Turning off the power should be avoided while using the Menu.
- Adjustments for Position, Clock and Phase are saved for each signal timing. Except for these adjustments, all other adjustments have only one setting which applies to all signal timings.





ADJUSTMENT MENU CONTENTS

PC Analog / PC Digital Input

Picture Control		
		
Adjustment Item	Problem / Option	Button to Press
Brightness *1	Too dark	
	Too bright	
Contrast	Too dull	
	Too intense	
H Position *2	 Too far to the left	
	 Too far to the right	
V Position *2	 Too low	
	 Too high	
Clock *2	To correct flickering text or lines	 
Phase *2	To correct flickering text or lines	 

*1 Adjust the Brightness when you are using the monitor in a dark room and feel the screen is too bright.

*2 Available for PC Analog input only. See page 12 for SCREEN ADJUSTMENTS.

Sound Control		
		
Adjustment Item	Problem / Option	Button to Press
Treble	Too weak	
	Too strong	
Bass	Too weak	
	Too strong	
Surround	Off	Surround sound effect is turned off.
	On	To simulate a realistic stereo sound



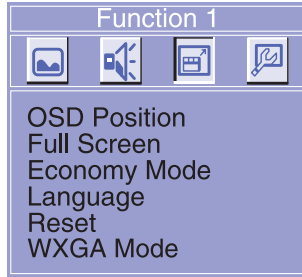





Function 1



Adjustment Item		Problem / Option
OSD Position	Upper Left	OSD is displayed at upper left of the screen.
	Upper Right	OSD is displayed at upper right of the screen.
	Center	OSD is displayed at center of the screen.
	Lower Left	OSD is displayed at lower left of the screen.
	Lower Right	OSD is displayed at lower right of the screen.
Full Screen	Off	The picture is displayed at the optimum resolution.
	On	Stretch the picture to fit the full screen.
Economy Mode	Mode 1	Brightness of back-light is reduced by 20%.
	Mode 2	Brightness of back-light is reduced by 40%.
	Off	Normal
Language	English	English
	Deutsch	German
	Français	French
	Nederlands	Dutch
	Svenska	Swedish
Reset	No	Return to the adjustment item line.
	Yes	Factory-preset data is restored.
WXGA Mode	Off	Set to Off when resolution setting of PC is other than WXGA (1280 × 768).
	On	Set to On when resolution setting of PC is WXGA (1280 × 768).

NOTE Adjust the screen size at resolutions of less than 1280 × 768. When selecting “On”, displayed text or lines may be blurred, or brightness may not be uniform when inputting stripe pattern signal or the like.

- NOTE**
- Factory-preset is “On”. Set to “Off” when the resolution is other than WXGA because the picture is not displayed normally.
 - When selecting digital input, WXGA and other than WXGA is selected automatically independently of this function.

Adjustment Item		Problem / Option	Button to Press	
<div style="border: 1px solid black; padding: 5px; margin-bottom: 10px;"> <p style="text-align: center; margin: 0;">Function 2</p> <div style="display: flex; justify-content: space-around; margin: 5px 0;">  </div> <p style="margin: 0;">Sharpness Color Control Auto Balance PIP PIP Control</p> </div>				
Sharpness		Adjust the picture quality at resolutions of less than 1280 × 768 when selecting "On" at "Full Screen" on Function 1.		
Color Control ^{*3}	Mode 1 (≈9300K)	Bluish white (Approx. 9300K)		
	Mode 2 (≈7500K)	Yellowish white (Approx. 7500K)		
	Mode 3 (≈6500K)	Reddish white (Approx. 6500K)		
	User	Red	Too weak 	
	Green	Too strong 		
	Blue			
Auto Balance ^{*4}	No	Return to the adjustment item line.		
	Yes	Adjust the Red, Green and Blue to suitable colors automatically.		
<p>NOTE</p> <ul style="list-style-type: none"> ■ For the Auto Balance to work correctly, display a white window no smaller than 5cm × 5cm. ■ This adjustment takes approximately five seconds and then the screen becomes dark. ■ The Auto Balance may not work correctly due to your computer system, resolution or displayed pattern. In this case, select "Reset" on Function 1 and restore factory-preset data. 				
PIP ^{*5}	Off	PIP function is turned off.		
	On	PIP function is turned on.		
PIP Control ^{*5}	H Position	Sub screen is too far to the left		
		Sub screen is too far to the right		
	V Position	Sub screen is too low		
		Sub screen is too high		
	PIP Size	1	Sub screen is displayed at minimum size.	
		2	Sub screen is displayed at normal size.	
		3	Sub screen is displayed at maximum size.	
	Source Select	TV	Display a TV picture in the sub screen.	
		AV-1	Display a AV-1 picture in the sub screen.	
		AV-2	Display a AV-2 picture in the sub screen.	
Sound Select	Main	Output the sound from the computer.		
	Sub	Output the sound from the signal source for sub screen.		

*3 The indicated color temperature in Kelvin is approximately the standard.

*4 Available for PC Analog input only.

*5 Available only when OTA3-2PS or OTA3-2PSB is installed in the monitor, and vertical frequency of PC input is 60Hz.

PIP = Picture in Picture:

With this function, you can display two different pictures, such as a picture from the computer in the main screen and a TV / DVD / Video picture in the sub screen at the same time. Select "On" at "Full Screen" on Function 1 first.

SCREEN ADJUSTMENTS

Adjust the image by following the procedure below to get the desired picture when selecting PC Analog input.

- The screen adjustments described in this manual are designed to set image position and minimize flicker or blur for the particular computer in use.
- The monitor is designed to provide the best performance at resolution of 1280 × 768, but can not provide the best at resolutions of less than 1280 × 768 because the picture is automatically stretched to fit the full screen. It is recommended to operate at a resolution of 1280 × 768 in normal use.
- Displayed text or lines will be blurred or irregular in thickness when the picture is stretched due to the screen enlargement process.
- It is preferable to adjust the image position and frequency with the monitor controls, rather than with computer software or utilities.
- Perform adjustments after a warm-up period of at least thirty minutes.
- Additional adjustments may be required after the Auto Set-up depending on the resolution or signal timing.
- The Auto Set-up may not work correctly when displaying the picture other than the screen adjustment pattern. In this case, manual adjustments are required.

There are two ways to adjust the screen. One way is automatic adjustment for Clock, Phase and Position. The other way is performing each adjustment manually.

Perform the Auto Set-up first when the monitor is connected to a new computer, or resolution is changed. If the screen has a flicker or blur, or the picture does not fit in the display area after performing the Auto Set-up, manual adjustments are required. Both adjustments should be made by using the screen adjustment pattern (Test.bmp) obtained via the iiyama web site (<http://www.iiyama.com> or <http://www.iiyama.co.uk>).

This manual explains adjustment under Windows 95/98/2000/Me/XP.

- ① Set the Full Screen feature to Off and display the picture at the optimum resolution.
- ② Enter the Test.bmp (screen adjustment pattern) to wallpaper.

NOTE

- Consult the appropriate documentation for doing this.
- Test.bmp is made at resolution of 1280 × 1024. Set the display position to center in the wallpaper setting dialogue box. If you use Microsoft® PLUS! 95/98 cancel the setting of "Stretch desktop wallpaper to fit the screen".

[Adjustment pattern]

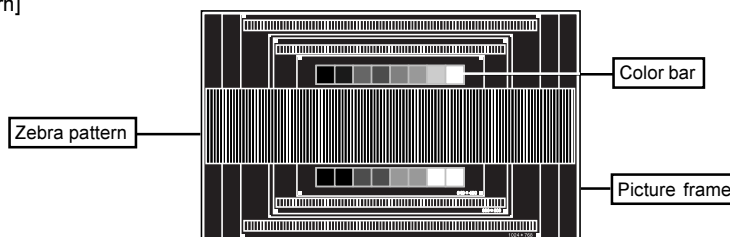

This is the image displayed at 1280 × 768.

- ③ Press the Auto Button for one second or more when the menu page is not displayed. (Auto Set-up)
- ④ Adjust the image manually by following procedure below when the screen has a flicker or blur, or the picture does not fit in the display area after performing the Auto Set-up.
- ⑤ Adjust the V Position so that the top and bottom of the picture frame will fit to the display area.

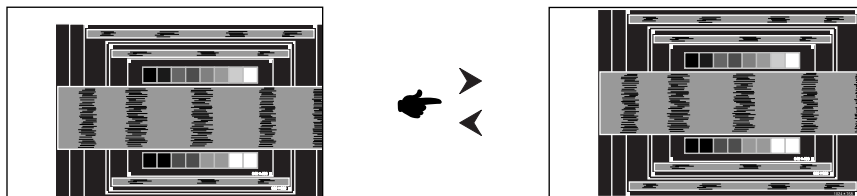

- ⑥ 1) Adjust the H Position so that the left side of the picture frame will move to the left edge of the display area.

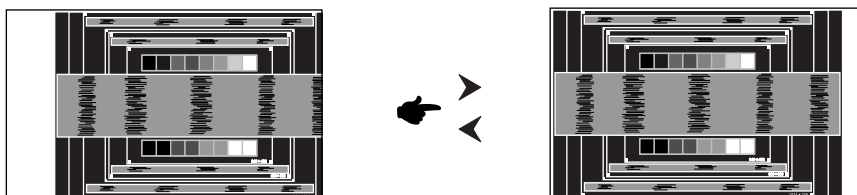

2) Stretch the right side of the picture frame to the right edge of the display area by adjusting the Clock.

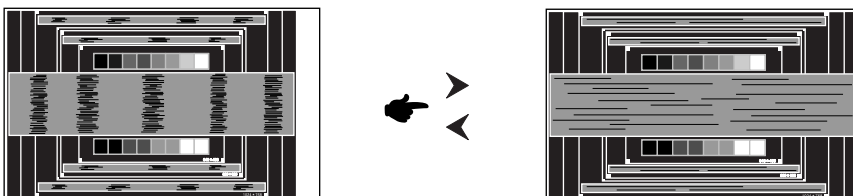

- NOTE**
- When the left side of the picture frame moves apart from the left edge of the display area during the Clock adjustment, adjust steps 1) and 2).
 - Another way to make the Clock adjustment is to correct the vertical wavy lines in the zebra pattern.
 - The picture may flicker during the Clock, H Position and V Position adjustment.
 - In case the picture frame is bigger or smaller than the data display area after the Clock adjustment, repeat steps from ③.

⑦ Adjust the Phase to correct horizontal wavy noise, flicker or blur in the zebra pattern.

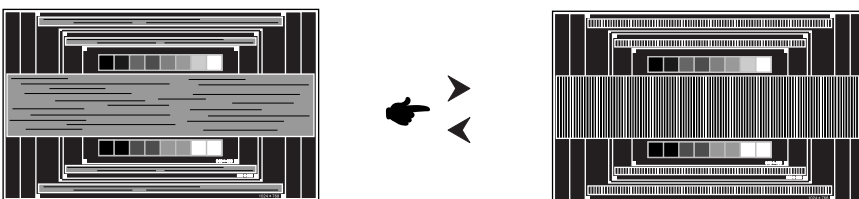

- NOTE**
- In case the strong flicker or blurs remain on a part of the screen, repeat steps ⑥ and ⑦ because the Clock may not be adjusted correctly. If the flicker or blurs still remain, set the refresh rate of computer to low (60Hz) and repeat steps from ③ again.
 - Adjust the H Position after the Phase adjustment if the horizontal position moves during the adjustment.

⑧ Adjust the Brightness and Color Control to get the desired picture after you complete the Clock and Phase adjustments. Put back your favorite wallpaper.

POWER MANAGEMENT FEATURE

The power management feature of this product complies with every power saving requirement of ENERGY STAR® and VESA DPMS. When activated, it automatically reduces unnecessary power consumption of the monitor when your computer is not in use. To use the feature, the monitor needs to be connected to a VESA DPMS compliant computer. There is a power management step the monitor takes as described below. The power management function, including any timer settings is configured by the operating system. Check your operating system manual for information on how this can be configured.

Power Management Mode

When the H-sync signal / V-sync signal / H and V sync signals from the computer are off, the monitor enters into Power Management Mode which reduces the power consumption to less than 5W. The screen becomes dark, and the power indicator turns to orange. From Power Management Mode, the image reappears in several seconds when either the keyboard or the mouse are touched again.

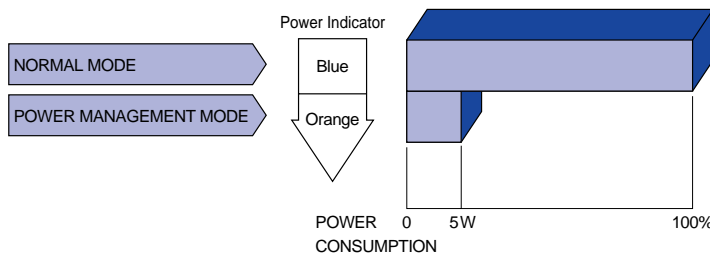

- NOTE**
- Even when using the power management mode, the monitor consumes electricity. Turn off the Power Switch whenever the monitor is not in use, during the night and weekends, to avoid unnecessary power consumption.
 - It is possible that the video signal from the computer may be on while the H or V sync signal is missing. In this instance, the POWER MANAGEMENT feature may not work properly.

TROUBLE SHOOTING

If the monitor fails to operate correctly, please follow the steps below for a possible solution.

1. Perform the adjustments described in OPERATING THE MONITOR, depending on the problem you have. If the monitor does not get a picture, skip to 2.
2. Consult the following items if you cannot find an appropriate adjustment item in OPERATING THE MONITOR or if the problem persists.
3. If you are experiencing a problem which is not described below or you cannot correct the problem, discontinue using the monitor and contact your dealer or iiyama service center for further assistance.

Problem	Check
① The picture does not appear.	
(Power indicator does not light up.)	<input type="checkbox"/> The Power Cable is firmly seated in the socket. <input type="checkbox"/> The Power Switch is turned ON. <input type="checkbox"/> The AC socket is live. Please check with another piece of equipment.
(Power indicator is blue.)	<input type="checkbox"/> If the blank screen saver is in active mode, touch the keyboard or the mouse. <input type="checkbox"/> Increase the Contrast and/or Brightness. <input type="checkbox"/> The computer is ON. <input type="checkbox"/> The Signal Cable is properly connected. <input type="checkbox"/> The signal timing of the computer is within the specification of the monitor.
(Power indicator is orange.)	<input type="checkbox"/> If the monitor is in power management mode, touch the keyboard or the mouse. <input type="checkbox"/> If the input signal selection is different, switch the input signal. <input type="checkbox"/> The computer is ON. <input type="checkbox"/> The Signal Cable is properly connected. <input type="checkbox"/> The signal timing of the computer is within the specification of the monitor. <input type="checkbox"/> The Power Switch is turned ON.
② The screen is not synchronized.	<input type="checkbox"/> The Signal Cable is properly connected. <input type="checkbox"/> The signal timing of the computer is within the specification of the monitor. <input type="checkbox"/> The video output level of the computer is within the specification of the monitor.
③ The screen position is not in the center.	<input type="checkbox"/> The signal timing of the computer is within the specification of the monitor.
④ The screen is too bright or too dark.	<input type="checkbox"/> The video output level of the computer is within the specification of the monitor.
⑤ The screen is shaking.	<input type="checkbox"/> The power voltage is within the specification of the monitor. <input type="checkbox"/> The signal timing of the computer is within the specification of the monitor.
⑥ No sound from the speakers.	<input type="checkbox"/> The Speaker Cable is properly connected. <input type="checkbox"/> The sound volume is minimum.

APPENDIX A

SPECIFICATIONS

		ProLite L403W	ProLite L323W
LCD Panel	Driving system	a-Si TFT Active Matrix	
	Size	Diagonal: 101cm / 39.6"	Diagonal: 80.2cm / 32"
	Pixel pitch	0.6735mm H × 0.6735mm V	
	Brightness	500cd/m ² (Typical)	
	Contrast ratio	600 : 1 (Typical)	500 : 1 (Typical)
	Viewable angle	Right / Left / Up / Down: 85 degrees each	
	Response time	22ms (Black, white, black)	33ms (Black, white, black)
Display Colors	16,777,216 maximum		
Sync Frequency	Horizontal: 31.47-60.24kHz, Vertical: 56-75Hz		
Dot Clock	102.98MHz maximum		
Maximum Resolution	1280 × 768, 1 Mega Pixels		
Input Video Connector	DVI-I 29pin		
Plug & Play	VESA DDC2B™		
Input Sync Signal	Separate sync: TTL, Positive or Negative Composite sync: TTL, Positive or Negative		
Input Video Signal	Analog: 0.7Vp-p (Standard), 75Ω, Positive Digital: DVI (Digital Visual Interface standard Rev.1.0) compliance		
Input Audio Connector	ø 3.5mm stereo mini jack		
Input Audio Signal	0.5Vrms maximum		
Output Audio Connector	RCA pin jack R/L		
Speakers	7W × 2 (Stereo)		
Maximum Screen Size	862.080mm W × 517.248mm H / 33.9" W × 20.4" H	687.36mm W × 412.42mm H / 27.1" W × 16.2" H	
Power Source *1	100-230VAC, 50/60Hz, 2.3-1.0A		100-230VAC, 50/60Hz, 1.95-0.85A
Power Consumption *2	230W maximum Power management mode: 5W maximum *3		190W maximum
Dimensions	1140 × 640 × 300mm / 44.9 × 25.2 × 11.8" (W×H×D) 38kg / 83.8lbs (With Speakers)		978 × 530 × 300mm / 38.5 × 20.9 × 11.8" (W×H×D) 28kg / 61.7lbs (With Speakers)
Environmental Considerations	Operative temperature: 0 to 40°C / 32 to 104°F Storage temperature: -20 to 60°C / -4 to 140°F Humidity: 85% maximum (No condensation)		
Approvals	CE, TÜV-GS / MPR III (prEN50279), FCC, UL / C-UL, VCCI-B		

NOTE *1*2 Available only when OTA3-2PS or OTA3-2PSB is installed in the monitor.
*3 When AV equipment or antenna is not connected.

DIMENSIONS

ProLite L403W

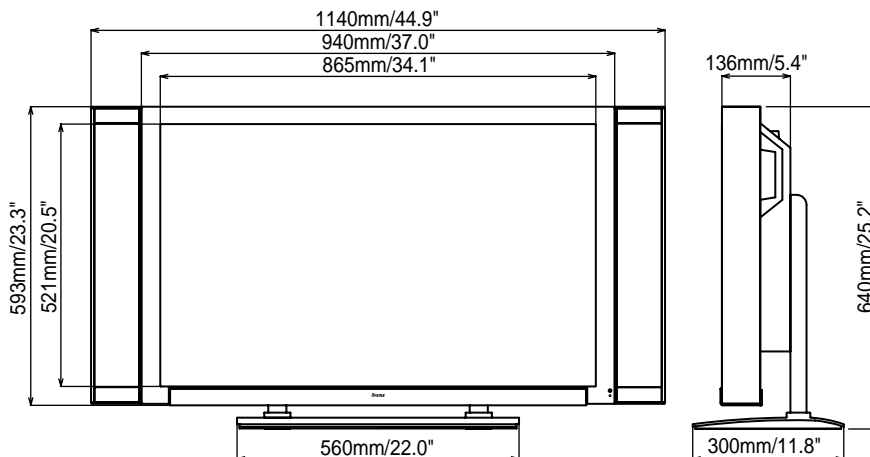

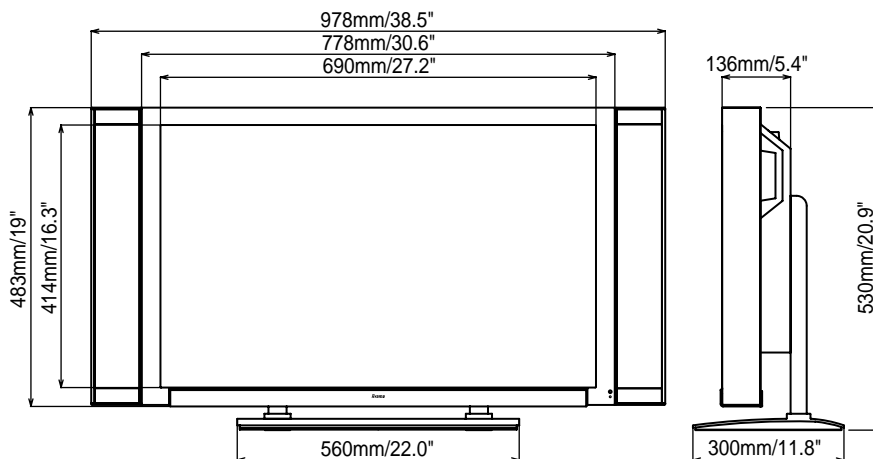

COMPLIANT TIMING

Video Mode		Horizontal Frequency	Vertical Frequency	Dot Clock	
VESA	VGA 640 × 480	31.469kHz	59.940Hz	25.175MHz	*1
		37.861kHz	72.809Hz	31.500MHz	
		37.500kHz	75.000Hz	31.500MHz	
	SVGA 800 × 600	37.879kHz	60.317Hz	40.000MHz	*1
		48.077kHz	72.188Hz	50.000MHz	
		46.875kHz	75.000Hz	49.500MHz	
	XGA 1024 × 768	48.363kHz	60.004Hz	65.000MHz	*1
		56.476kHz	70.069Hz	75.000MHz	
		60.023kHz	75.029Hz	78.750MHz	
	WXGA 1280 × 768*2	44.409kHz	56.000Hz	73.895MHz	
47.701kHz		60.000Hz	80.136MHz	*1	
VGA TEXT	720 × 400	31.469kHz	70.087Hz	28.322MHz	*3
Macintosh	640 × 480	35.000kHz	66.667Hz	30.240MHz	*3
	832 × 624	49.725kHz	74.500Hz	57.283MHz	*3
	1024 × 768	60.150kHz	74.720Hz	80.000MHz	*3

NOTE *1 PIP is available after installing OTA3-2PS or OTA3-2PSB in the monitor.
 *2 See page 10 for WXGA Mode.
 *3 Digital input is not compliant.

CONNECTOR PIN ASSIGNMENT

■ DVI-I 29pin Connector

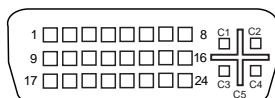

DVI-I

Pin	Input Signal	Pin	Input Signal
1	T.M.D.S Data 2-	16	Hot Plug Detect
2	T.M.D.S Data 2+	17	T.M.D.S Data 0-
3	T.M.D.S Data 2/4 Ground	18	T.M.D.S Data 0+
4	T.M.D.S Data 4-	19	T.M.D.S Data 0/5 Ground
5	T.M.D.S Data 4+	20	T.M.D.S Data 5-
6	Clock line (SCL) *	21	T.M.D.S Data 5+
7	Data line (SDA) *	22	T.M.D.S Clock Ground
8	Analog V-Sync	23	T.M.D.S Clock +
9	T.M.D.S Data 1-	24	T.M.D.S Clock -
10	T.M.D.S Data 1+	C1	Analog Red
11	T.M.D.S Data 1/3 Ground	C2	Analog Green
12	T.M.D.S Data 3-	C3	Analog Blue
13	T.M.D.S Data 3+	C4	Analog H-Sync
14	+5V Power	C5	Analog Ground
15	Ground		

* Compliant to VESA DDC.

APPENDIX B

Optional TUNER / VIDEO Input

APPENDIX B is available only when the optional Tuner / Video Adapter is installed in the monitor.
For more details, please refer to the user manual for the optional Tuner / Video Adapter.

REMOTE CONTROL

- CAUTION** ■ Do not use any other batteries other than those specified in this manual for the Remote Control. Do not insert old and new batteries together in the Remote Control. Make sure that the terminals match the “+” and “-” indications in the battery compartment. Burst batteries or the electrolyte from these batteries may cause stains, fire or injury.
- NOTE** ■ Replace with new batteries when the Remote Control does not work close to the monitor. Use AA dry batteries.
- Operate the Remote Control by pointing it toward the Remote Sensor on the monitor.
- Other manufacturers remote control will not work with this monitor. Use the provided Remote Control ONLY.

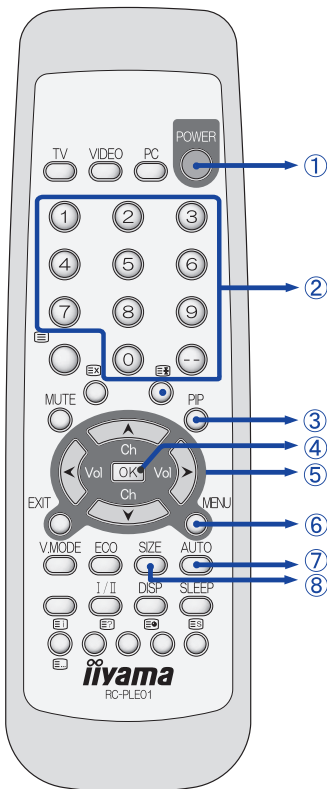
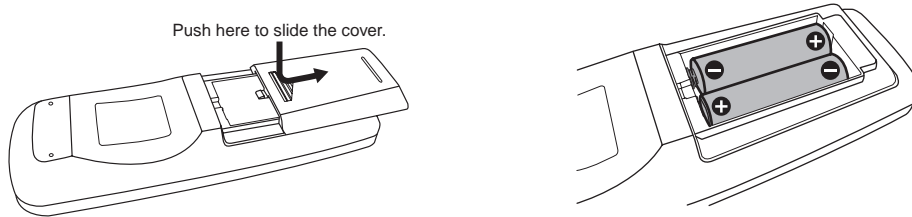

- ① POWER
- ② TV Channel
Select a regular TV (VHF / UHF) or CATV channel.
- ③ PIP (Picture in Picture)
With this function, you can display two different pictures, such as a picture from the computer in the main screen and a picture of TV, DVD or Video in the sub screen at the same time. Press again to turn off this function.
NOTE ■ Available only when vertical frequency of PC input is 60Hz.
■ Not available when the Full Screen feature is “Off”.
- ④ OK
Confirm a selected menu item or setting.
- ⑤ Ch: Channel Select (▼ / ▲)
TELETEXT Page (▼ Previous / ▲ Next)
Vol: Volume Control (◀ / ▶)
- ⑥ MENU
- ⑦ AUTO
Adjust H Position, V Position, Clock, Phase automatically.
NOTE ■ Available for PC Analog input only.
■ Press the AUTO Button when the Menu is not displayed.
- ⑧ SIZE
This is switched when you successively press the button as follows:
 - Computer connection:
→ Optimum resolution → Stretch
 - AV equipment / Antenna connection:
→ Full screen → Ratio 4:3 → Ratio 16:9
 - When TELETEXT is displayed:
→ Full screen → Upper half stretch → Lower half stretch

NOTE About details for ①, ⑤ and ⑥, see page 19 for BASIC OPERATION. For ③, see page 11 for PIP. For ⑦, see page 4 for “⑤ Auto Button”. For ⑧, see page 10 or 22 for “Full Screen”.

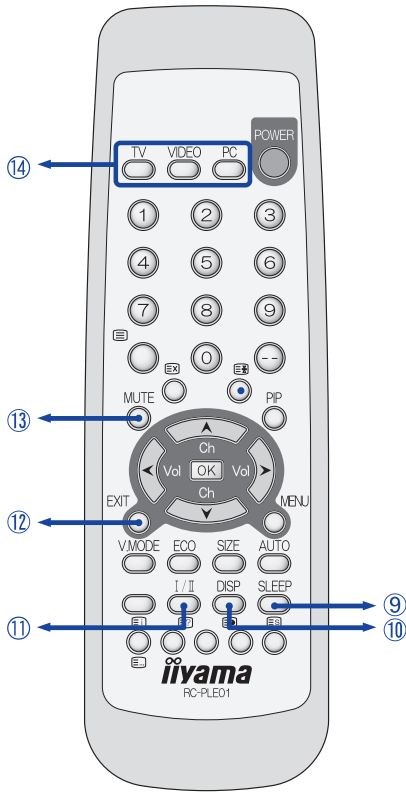

⑨ SLEEP

Turn off the monitor automatically after selected period of time when antenna is connected. This is switched when you successively press the button as follows:

→ 30min → 60min → 120min → 0min(Off) □

⑩ DISP

Following information is displayed on the screen.

- Computer connection: Input signal timing
- Antenna connection: Channel number, Sound setting

⑪ I / II

This is switched when you successively press the button as follows:

■ Stereo broadcasting:
→ Mono → Stereo □

■ NICAM Stereo broadcasting:
→ NICAM Stereo → Mono □

■ Voice multiple broadcasting:
→ Dual I → Dual II □

■ NICAM Dual broadcasting:
→ NICAM Dual I → NICAM Dual II → Mono □

■ NICAM Mono broadcasting:
→ NICAM Mono → Mono □

⑫ EXIT

Go back to the previous screen when the menu page is displayed on the screen.

⑬ MUTE

Turn off the sound temporarily. Press again to return the sound volume to the previous level .

⑭ TV / VIDEO / PC (Input Signal Select)

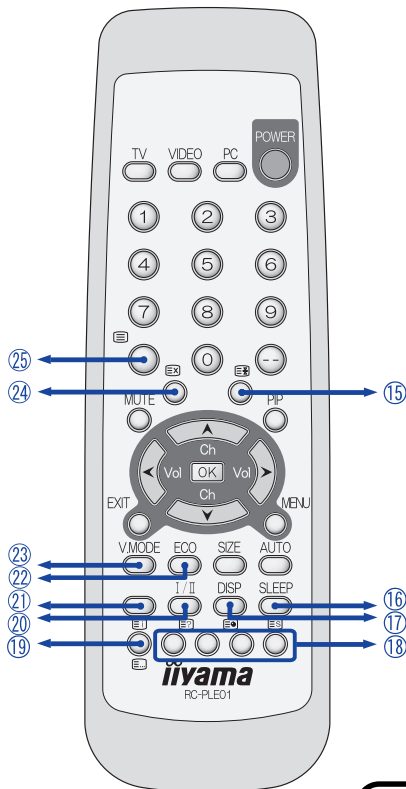

⑮ HOLD

⑯ STORE (SLEEP)

⑰ SUB PAGE (DISP)

⑱ RED / GREEN / YELLOW / CYAN

⑲ LIST

⑳ REVEAL (I / II)

㉑ INDEX

㉒ ECO (Economy Mode)

The brightness of the backlight is switched as follows when you successively press the button to save the power consumption of the monitor.

→ Mode1 → Mode2 → Off □

㉓ V.MODE (Video Mode)

This is switched as follows when you successively press the button when AV equipment or antenna is connected.

→ Standard → Movie → Game → User □

㉔ CANCEL

㉕ TELETEXT DISPLAY

NOTE

- ⑮, ⑯, ⑰, ⑱, ⑲, ⑳, ㉑, ㉒ and ㉕ are TELETEXT functions, and available for Tuner / AV1 / AV2 input. For details regarding TELETEXT, see page 25.
- About details for ⑭, see page 19 for BASIC OPERATION.
- For ㉒, see page 10 or 22 for "Economy Mode". For ㉓, see page 22 for "Video Mode".

BASIC OPERATION

■ Turn on the monitor

Monitor is turned ON and the Power Indicator turns to blue when you connect the Power Cable to the power supply. The monitor is turned OFF and the Power Indicator turns to orange when you press the Power Switch on the monitor or the Remote Control. Press again to turn ON the monitor.

[Monitor] Press the Power Switch.

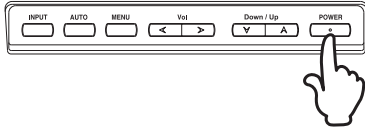

NOTE Even when using the power management mode or turning OFF the Power Switch, the monitor will consume a small amount of electricity. Disconnect the Power Cable from the power supply whenever the monitor is not in use, during the night, to avoid unnecessary power consumption.

■ Select channel, Move the cursor vertically

Press the Channel Select Button (▼ / ▲) on the monitor or the Remote Control to select a TV channel when the menu page is not displayed on the screen.*

Select adjustment by pressing the Channel Select Button (▼ / ▲) while the menu page is displayed on the screen.

[Monitor] Press the Down / Up: Channel Select Button (▼ / ▲).

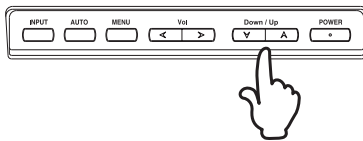

* When antenna is connected.

NOTE You can select only the channels set to "Skip Off" at "Channel Set-up".

■ Adjust the volume of sound, Move the cursor horizontally

Press the Vol: Volume Control Button (◀ / ▶) on the monitor or the Remote Control to adjust the volume of sound when the menu page is not displayed on the screen.

Select menu or setting, or perform the adjustment by pressing the Vol: Volume Control Button (◀ / ▶) while the menu page is displayed on the screen.

[Monitor] Press the Vol: Volume Control Button (◀ / ▶).

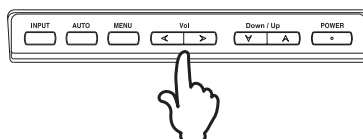

[Remote Control] Press the Power Switch.

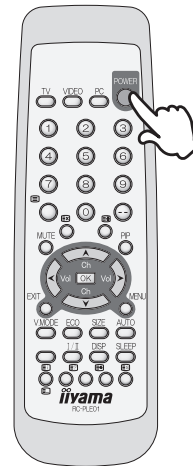

[Remote Control] Press the Ch: Channel Select Button (▼ / ▲).



[Remote Control] Press the Vol: Volume Control Button (◀ / ▶).

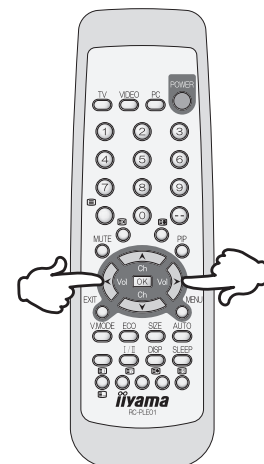

■ Display the adjustment menu page

The menu page appears on the screen when you press the MENU Button on the monitor or the Remote Control.

The menu page disappears when you press the Menu Button on the Remote Control again.

[Monitor] Press the MENU Button.

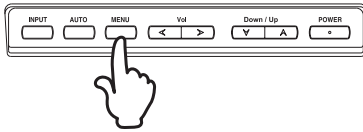

[Remote Control] Press the MENU Button.

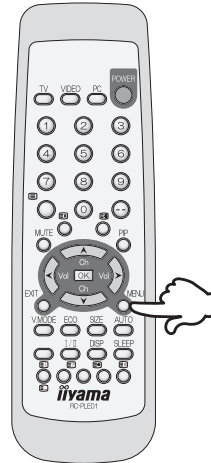

NOTE The MENU Button on the monitor is also used to confirm a selected menu item or setting.

■ Switch the input signal

This is switched when you successively press the Input Button on the monitor as follows:

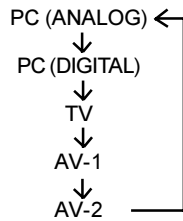

[Monitor] Press the Input Button.

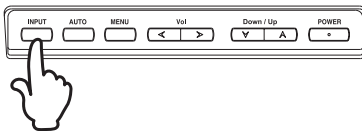

[Remote Control] Press the Input Signal Select Button.

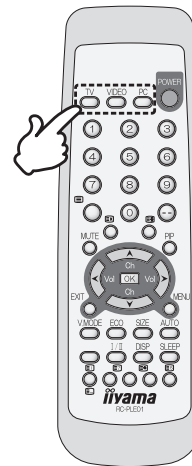

This is switched when you successively press the button as follows:

- TV: TV is ON.
- VIDEO: [AV1 → AV2]
- PC: [PC Analog → PC Digital]

SELECTION OF TV CHANNEL

To select a TV channel, pick the program number you want on Channel Set-up.

■ Method by using Ch Up ▲ / Down ▼ button

You can select channels in numerical order by pressing Ch Up button ▲ on the remote control or Up button ▲ on the monitor in TV input. You can select channels in reverse by pressing Ch Down button ▼ on the remote control or Down button ▼ on the monitor.

NOTE You can select only the program number which you set the SKIP function"Off".

■ Method by using number button

<Program number 1-9>

You can select the channel you set up on program number by pressing the number button.

<Program number 10-99>

--is displayed on the screen by pressing [0] button.

Enter the program number you want to select by pressing the number button.

(e.g. Program number 15)



ADJUSTMENT MENU CONTENTS

TV / AV-1 / AV-2 Input

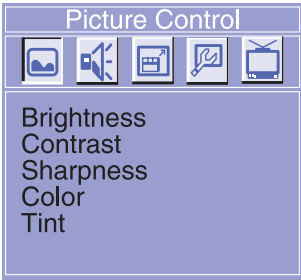
Picture Control *1 (TV / AV-1 / AV-2)		
		
Adjustment Item	Problem / Option	Button to Press
Brightness *2	Too dark	← →
	Too bright	→ ←
Contrast *2	Too dull	← →
	Too intense	→ ←
Sharpness	To adjust picture quality	← →
Color	Too weak	← →
	Too strong	→ ←
Tint (NTSC)	Purplish	← →
	Greenish	→ ←

*1 Available only when selecting "User" at "Video Mode" on Function 1. See page 22 for Video Mode.

*2 Adjust the Brightness and Contrast so that the picture is displayed naturally in VIDEO input mode.

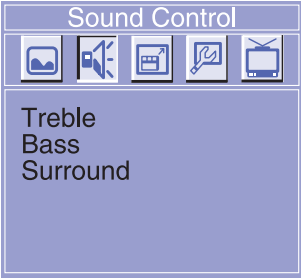
Sound Control (TV / AV-1 / AV-2)		
		
Adjustment Item	Problem / Option	Button to Press
Treble	Too weak	← →
	Too strong	→ ←
Bass	Too weak	← →
	Too strong	→ ←
Surround	Off	Surround effect is turned off.
	On	To simulate a realistic stereo sound

Function 1
(TV / AV-1 / AV-2)

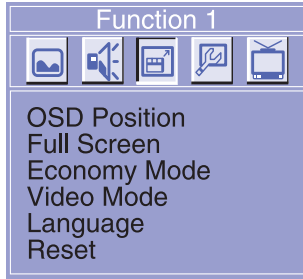

Adjustment Item		Problem / Option
OSD Position	Upper Left	OSD is displayed at upper left of the screen.
	Upper Right	OSD is displayed at upper right of the screen.
	Center	OSD is displayed at center of the screen.
	Lower Left	OSD is displayed at lower left of the screen.
	Lower Right	OSD is displayed at lower right of the screen.
Full Screen	Mode 1	Stretch the picture to fit the full screen.
	Mode 2	Displays stretched picture in the ratio of 4:3.
	Mode 3	Displays the picture in the ratio of 16:9.
NOTE The picture lacks right and left when selecting "Mode 1".		
Economy Mode	Mode 1	Brightness of back-light is reduced by 20%.
	Mode 2	Brightness of back-light is reduced by 40%.
	Off	Normal
Video Mode ^{*3}	Standard	Normal
	Movie	Suitable for a dark screen such as movie
	Game	Suitable for Games
	User	Display a picture on a screen set by Picture Control adjustments.
Language	English	English
	Deutsch	German
	Français	French
	Nederlands	Dutch
	Svenska	Swedish
	Italiano	Italian
Reset	No	Return to the adjustment item line.
	Yes	Factory-preset data is restored.

^{*3} Picture Control adjustment is not available when you select "Standard", "Movie" or "Game".

Function 2
(TV / AV-1 / AV-2)

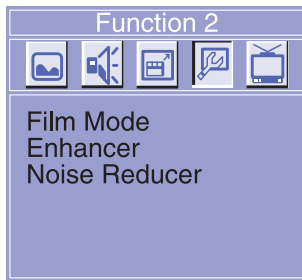

Adjustment Item		Problem / Option
Film Mode	Off	Film Mode is turned off.
	On	To make a film picture such a movie natural without shakiness
Enhancer	Off	Enhancer is turned off.
	On	To enhance the picture outline
<p>NOTE Noise may be noticeable depending on the picture displayed.</p>		
Noise Reducer	Off	Noise Reducer is turned off.
	On	To reduce the noise of picture
<p>NOTE Whole screen may be blurred depending on the picture displayed.</p>		

**Channel Set-up is available for TV Input only.
This should be implemented first when you use the monitor as a television.**

ENGLISH

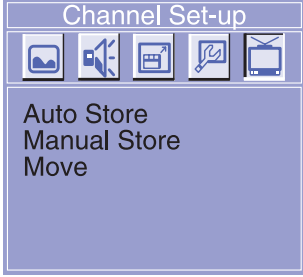
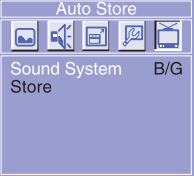
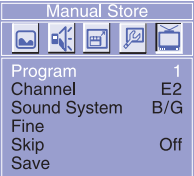
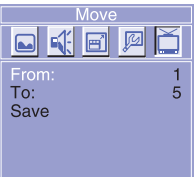
Adjustment Item		Problem / Option	Button to Press
<p>Channel Set-up (TV)</p> 			
<p>Auto Store</p> 	Sound System*1	B/G	Select the Sound System of the received broadcasting station. ← →
		I	
		D/K	
	Store	No	Return to the line of the adjustment items.
		Yes	Select the receivable channels automatically.
	Store (Cable)	No	Return to the line of the adjustment items.
Yes		Select the receivable channels automatically.	
<p>NOTE</p> <ul style="list-style-type: none"> Some channels are not selected automatically depending on the signal condition. Select "Store (Cable)" when the broadcasting frequency is different from the one listed on the Table for receivable channels. (e.g. Cable TV) <p>In this case, it takes approximately 10 minutes to exit.</p>			
<p>Manual Store</p> 	Program		Select the program number. ← →
	Channel*2		Select the channel number. ← →
	Sound System*1		Select the Sound System of the received broadcasting station. ← →
	Fine Tune		Fine tune the frequency of the selected channel if the picture is distorted depending on the signal condition. ← →
	Skip	Off	Ch Up / Down key on the remote control or the monitor enables you to select the channels.
		On	Ch Up / Down key on the remote control or the monitor enables you to skip when you select the channels.
Save		Save the complete installed contents.	
<p>Move</p> 	From		Select the program number of the channel you want to move. ← →
	To		Select the program number that you want to move the channel to. ← →
	Save		Save the installed contents.

*1 If you do not select Sound System properly, the noise may be generated in the sound or the vertical wavy lines in the zebra pattern may appear in the picture.

Sound System vary by region as follows:

B/G: West Europe I: U.K. , Ireland D/K: East Europe L: France

For more details, please contact your local iiyama dealer or regional iiyama office.

*1*2 For the receivable channels on each Sound System, see Table for receivable channels.

TELETEXT FUNCTION

■ Switching of TELETEXT functions

This is switched when you successively press the  button as follows:

➤ TEXT mode → MIX mode → TV mode ➤

A black screen appears in TEXT mode when the received channel does not contain TELETEXT broadcasting.

■ Selection of the page

Enter the page number by using the number button on the remote control in TEXT mode or MIX mode. The page number you entered appears on the upper left of the screen.

The next page appears by pressing Ch Up button on the remote control, and the previous page appears by pressing Ch Down button on the remote control in TEXT mode or MIX mode.

■ Change of the screen size



Upper half zoom and lower half zoom are switched by pressing the SIZE button on the remote control in TEXT mode or MIX mode.

■ LIST mode







Color button can store the certain page in LIST mode.

1. Switch to LIST mode.
2. Select by pressing the color button you want it to store.
3. Enter the page number you want to store by pressing the number button on the remote control.
4. Press the STORE  button.

■ Change of character

When character of TELETEXT is not displayed normally, change the character setting. Press the MENU Button in TEXT mode or MIX mode to display the character setting menu. Then, select appropriate setting by using the  /  Buttons.

■ Description of each button

CANCEL 	Cancel TELETEXT. TV screen appears by pressing CANCEL button in TEXT mode or MIX mode. TELETEXT appears by pressing the button again. This button is used when you want to watch TV temporarily.
HOLD 	When Multi page appears, it stops page's automatic switching temporarily. Release the setting by pressing the button again.
INDEX 	Display the INDEX page.
REVEAL 	Display a hidden information. (e.g. Answer to a quiz) It disappears by pressing the button again.
SUBPAGE 	Switch between SUBPAGE mode and NORMAL mode. Display S **** on the upper left of the screen by switching to SUBPAGE mode. Enter SUBPAGE number by using the number button on the remote control.
LIST 	Switch between LIST mode and FLOF / TOP mode.
RED/GREEN/ YELLOW/CYAN	Select the items on the lower part of the screen in LIST, FLOF, or TOP mode.

SPECIFICATIONS

Input Video Connector	SCART (Composite / RGB) RCA pin jack (Composite) S-Video
Video Signal System *	AV-1 / AV-2: PAL, SECAM, NTSC
TV Signal System	PAL B/G/I/D/K, SECAM B/G/D/K/L
TV Stereo System	NICAM, A2
TELETEXT	LEVEL 1.5, TOP / FLOF, 10 page
Antenna Input	VHF / UHF, 75Ω, Unbalanced
Receive Channel	VHF: F2-F10 / E2-E12 / IRA-IRJ / R I -RX II UHF: E21-E69 CATV: S1-S41 / FB-FQ
Input Audio Connector	SCART, RCA pin jack R/L

NOTE * Not all broadcast systems are supported.

Table for receivable channels

B / G				I				L				D / K			
AIR		CATV		AIR		CATV		AIR		CATV		AIR		CATV	
Ch.	Freq. (MHz)	Ch.	Freq. (MHz)	Ch.	Freq. (MHz)	Ch.	Freq. (MHz)	Ch.	Freq. (MHz)	Ch.	Freq. (MHz)	Ch.	Freq. (MHz)	Ch.	Freq. (MHz)
E2	48.25	S1	105.25	IR A	45.75	S1	105.25	F2	55.75	C1	116.75	R1	49.75	S1	105.25
E3	55.25	S2	112.25	IR B	53.75	S2	112.25	F3	60.50	C2	128.75	R2	59.25	S2	112.25
E4	62.25	S3	119.25	IR C	61.75	S3	119.25	F4	63.75	C3	140.75	R3	77.25	S3	119.25
E5	175.25	S4	126.25	IR D	175.25	S4	126.25	F5	176.00	C4	152.75	R4	85.25	S4	126.25
E6	182.25	S5	133.25	IR E	183.25	S5	133.25	F6	184.00	C5	164.75	R5	93.25	S5	133.25
E7	189.25	S6	140.25	IR F	191.25	S6	140.25	F7	192.00	C6	176.75	R6	175.25	S6	140.25
E8	196.25	S7	147.25	IR G	199.25	S7	147.25	F8	200.00	C7	188.75	R7	183.25	S7	147.25
E9	203.25	S8	154.25	IR H	207.25	S8	154.25	F9	208.00	C8	200.75	R8	191.25	S8	154.25
E10	210.25	S9	161.25	IR J	215.25	S9	161.25	F10	216.00	C9	212.75	R9	199.25	S9	161.25
E11	217.25	S10	168.25	I21	471.25	S10	168.25	S21	303.25	C10	224.75	R10	207.25	S10	168.25
E12	224.25	S11	231.25	I22	479.25	S11	231.25	S22	311.25	C11	236.75	R11	215.25	S11	231.25
E21	471.25	S12	238.25	I23	487.25	S12	238.25	S23	319.25	C12	248.75	R12	223.25	S12	238.25
E22	479.25	S13	245.25	I24	495.25	S13	245.25	S24	327.25	C13	260.75	E2	48.25	S13	245.25
E23	487.25	S14	252.25	I25	503.25	S14	252.25	S25	335.25	C14	272.75	E3	55.25	S14	252.25
E24	495.25	S15	259.25	I26	511.25	S15	259.25	S26	343.25	C15	284.75	E4	62.25	S15	259.25
E25	503.25	S16	266.25	I27	519.25	S16	266.25	S27	351.25	C16	296.75	E5	175.25	S16	266.25
E26	511.25	S17	273.25	I28	527.25	S17	273.25	S28	359.25			E6	182.25	S17	273.25
E27	519.25	S18	280.25	I29	535.25	S18	280.25	S29	367.25			E7	189.25	S18	280.25
E28	527.25	S19	287.25	I30	543.25	S19	287.25	S30	375.25			E8	196.25	S19	287.25
E29	535.25	S20	294.25	I31	551.25	S20	294.25	S31	383.25			E9	203.25	S20	294.25
E30	543.25	S21	303.25	I32	559.25	S21	303.25	S32	391.25			E10	210.25	S21	303.25
E31	551.25	S22	311.25	I33	567.25	S22	311.25	S33	399.25			E11	217.25	S22	311.25
E32	559.25	S23	319.25	I34	575.25	S23	319.25	S34	407.25			E12	224.25	S23	319.25
E33	567.25	S24	327.25	I35	583.25	S24	327.25	S35	415.25			E21	471.25	S24	327.25
E34	575.25	S25	335.25	I36	591.25	S25	335.25	S36	423.25			E22	479.25	S25	335.25
E35	583.25	S26	343.25	I37	599.25	S26	343.25	S37	431.25			E23	487.25	S26	343.25
E36	591.25	S27	351.25	I38	607.25	S27	351.25	S38	439.25			E24	495.25	S27	351.25
E37	599.25	S28	359.25	I39	615.25	S28	359.25	S39	447.25			E25	503.25	S28	359.25
E38	607.25	S29	367.25	I40	623.25	S29	367.25	S40	455.25			E26	511.25	S29	367.25
E39	615.25	S30	375.25	I41	631.25	S30	375.25	S41	463.25			E27	519.25	S30	375.25
E40	623.25	S31	383.25	I42	639.25	S31	383.25	E21	471.25			E28	527.25	S31	383.25
E41	631.25	S32	391.25	I43	647.25	S32	391.25	E22	479.25			E29	535.25	S32	391.25
E42	639.25	S33	399.25	I44	655.25	S33	399.25	E23	487.25			E30	543.25	S33	399.25
E43	647.25	S34	407.25	I45	663.25	S34	407.25	E24	495.25			E31	551.25	S34	407.25
E44	655.25	S35	415.25	I46	671.25	S35	415.25	E25	503.25			E32	559.25	S35	415.25
E45	663.25	S36	423.25	I47	679.25	S36	423.25	E26	511.25			E33	567.25	S36	423.25
E46	671.25	S37	431.25	I48	687.25	S37	431.25	E27	519.25			E34	575.25	S37	431.25
E47	679.25	S38	439.25	I49	695.25	S38	439.25	E28	527.25			E35	583.25	S38	439.25
E48	687.25	S39	447.25	I50	703.25	S39	447.25	E29	535.25			E36	591.25	S39	447.25
E49	695.25	S40	455.25	I51	711.25	S40	455.25	E30	543.25			E37	599.25	S40	455.25
E50	703.25		463.25	I52	719.25	S41	463.25	E31	551.25			E38	607.25	S41	463.25
E51	711.25			I53	727.25			E32	559.25			E39	615.25		
E52	719.25			I54	735.25			E33	567.25			E40	623.25		
E53	727.25			I55	743.25			E34	575.25			E41	631.25		
E54	735.25			I56	751.25			E35	583.25			E42	639.25		
E55	743.25			I57	759.25			E36	591.25			E43	647.25		
E56	751.25			I58	767.25			E37	599.25			E44	655.25		
E57	759.25			I59	775.25			E38	607.25			E45	663.25		
E58	767.25			I60	783.25			E39	615.25			E46	671.25		
E59	775.25			I61	791.25			E40	623.25			E47	679.25		
E60	783.25			I62	799.25			E41	631.25			E48	687.25		
E61	791.25			I63	807.25			E42	639.25			E49	695.25		
E62	799.25			I64	815.25			E43	647.25			E50	703.25		
E63	807.25			I65	823.25			E44	655.25			E51	711.25		
E64	815.25			I66	831.25			E45	663.25			E52	719.25		
E65	823.25			I67	839.25			E46	671.25			E53	727.25		
E66	831.25			I68	847.25			E47	679.25			E54	735.25		
E67	839.25			I69	855.25			E48	687.25			E55	743.25		
E68	847.25							E49	695.25			E56	751.25		
E69	855.25							E50	703.25			E57	759.25		
								E51	711.25			E58	767.25		
								E52	719.25			E59	775.25		
								E53	727.25			E60	783.25		
								E54	735.25			E61	791.25		
								E55	743.25			E62	799.25		
								E56	751.25			E63	807.25		
								E57	759.25			E64	815.25		
								E58	767.25			E65	823.25		
								E59	775.25			E66	831.25		
								E60	783.25			E67	839.25		
								E61	791.25			E68	847.25		
								E62	799.25			E69	855.25		
								E63	807.25						
								E64	815.25						
								E65	823.25						
								E66	831.25						
								E67	839.25						
								E68	847.25						
								E69	855.25						

IYAMA CORPORATION

710-1 Kitaowaribe, Nagano-shi 381-0014 Japan