

Notice

Important Safety Instructions

What the f50 Monitor Offers

What the f70 Monitor Offers

Unpacking the Monitor

Setting Up the Monitor

How to Install the Drivers

Adjusting the Monitor

Using the Monitor

Troubleshooting

LCD Monitor Quality and

Pixel Policy for f50 Monitor

LCD Monitor Quality and Pixel

Policy for f70 Monitor

Technical Specifications for the
f50 Monitor

Technical Specifications for the
f70 Monitor

HP f70 Audio System

Performance Specifications

Care and Cleaning

Environmental Information

Regulatory Information



hp pavilion f50/f70 D5063/D5064 15-inch/17-inch LCD Monitor

(15-inch/17-inch Viewable Image)

User's Guide

Notice

The information contained in the documents accompanying this product is subject to change without notice.

Hewlett-Packard makes no warranty of any kind with regard to this material, including, but not limited to, the implied warranties of merchantability and fitness for a particular purpose.

HP shall not be liable for errors contained herein or for incidental or consequential damages in connection with the furnishing, performance, or use of this material.

HP assumes no responsibility for the use or reliability of its software on equipment that is not furnished by HP.

These documents contain proprietary information that is protected by copyright. All rights are reserved. No part of these documents may be photocopied, reproduced, or translated to another language without the prior written consent of HP.

Hewlett-Packard Company
Home Products Division
P.O. Box 4010
Cupertino, CA 95014-4010
USA

© Copyright Hewlett-Packard Company, 2001. All rights reserved.

Hewlett-Packard is a registered trademark of Hewlett-Packard Company in the United States of America and other countries. Other brand or product names are trademarks of their respective holders.

f50 15-inch LCD Monitor

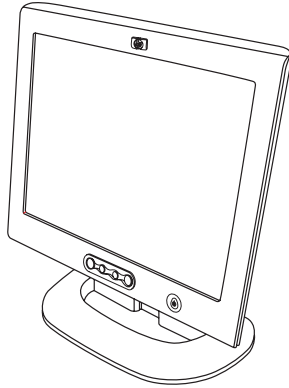

f70 17-inch LCD Monitor

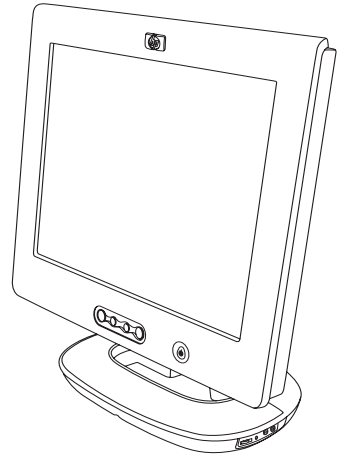

hp pavilion f50/f70
D5063/D5064
15-inch/17-inch
LCD Monitor
(15-inch/17-inch Viewable Image)
User's Guide

Important Safety Instructions



CAUTION: The lightning flash with arrowhead symbol inside an equilateral triangle is intended to alert the user to the presence of uninsulated, dangerous voltage which may be of sufficient magnitude to constitute a risk of electric shock.



WARNING: The exclamation point within an equilateral triangle is intended to alert the user to the presence of important operating and servicing instructions in the literature accompanying the appliance.



WARNING: If you are unsure that you can lift the equipment safely, do not try to move it without help.



WARNING: Before you connect any cables or install the HP monitor, refer to the above safety instructions. Also, refer to the set up poster and the documentation included with the PC and the video adapter to ensure this equipment is correctly installed.



WARNING: For your safety, always connect equipment to a grounded wall outlet. Always use a power cord with a properly grounded plug, such as the one provided with the equipment, or one in compliance with your national safety standards. This equipment can be disconnected from the power by removing the power cord from the power outlet. This means the equipment must be located close to an easily accessible power outlet.



WARNING: Use the monitor with the power adapter supplied with your HP monitor only.

To avoid electrical shock, do not open the monitor cover or the power adapter. There are no user-serviceable parts inside. Only qualified service personnel should service these parts.

Make sure the computer is turned off before connecting or disconnecting a display peripheral.

Working in Comfort

Thank you for selecting HP monitor equipment.

To optimize your comfort and productivity, it's important that you set up your work area correctly and use your HP equipment properly. With that in mind, we have developed some setup and use recommendations based on established ergonomic principles for you to follow.

These recommendations can be found in the online version of the Working in Comfort guide, which is preloaded on the hard disk of your HP computer. They can also be found on the HP Working in Comfort Web site at <http://www.hp.com/ergo/> along with other information.

What the f50 Monitor Offers

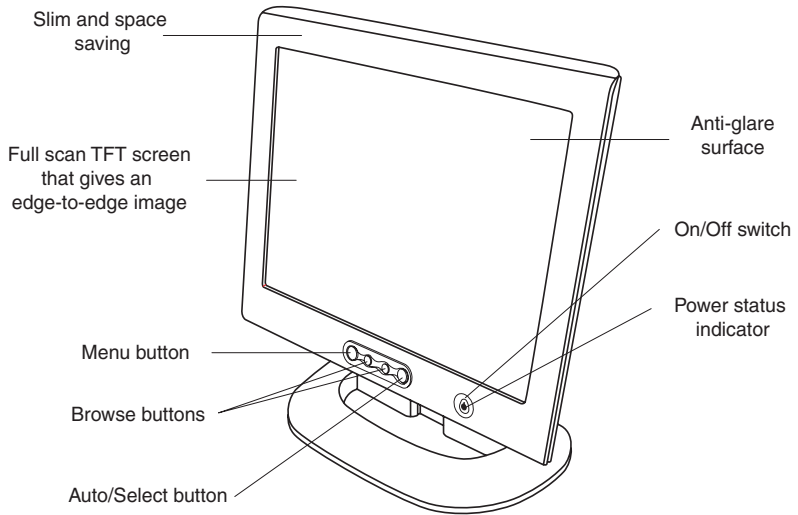

The HP f50 monitor is a liquid crystal display (LCD) 15-inch, high resolution, multi-synchronous color monitor. *Multi-synchronous* means that the monitor can be used with a range of video modes. It is optimized for use with all HP computers.

The HP f50 monitor has the following features:

- A 15-inch LCD; thin film transistor (TFT) with an anti-glare surface
- Support of video modes up to 1024 x 768 at a 75 Hz refresh rate
- Analog/Digital interface: a VGA (analog) and a DVI-D (digital) connector enables connection to two computers at the same time (optional)
- True color (16 million colors)
- Auto-adjustment of display position, clock, and phase for the VGA interface
- An onscreen display (OSD) manager that allows you to adjust all settings through onscreen menus

- Power-management system (VESA¹ standard) controlled from suitably equipped HP computers to automatically reduce the power consumption of the monitor

NOTE: *As an ENERGY STAR partner, HP has determined that this product meets ENERGY STAR guidelines for energy efficiency.*

- Low power consumption: 36 W maximum
- Compliance with stringent Swedish Low Emissions guidelines TCO '99
- Plug and Play capability (compliant with VESA DDC standard, version 3, revision 1 at the levels DDC1, DDC/2B, DDC/C1, version 1) that enables the monitor to identify itself to suitably equipped HP computers

1. VESA is the Video Electronics Standards Association.

What the f70 Monitor Offers

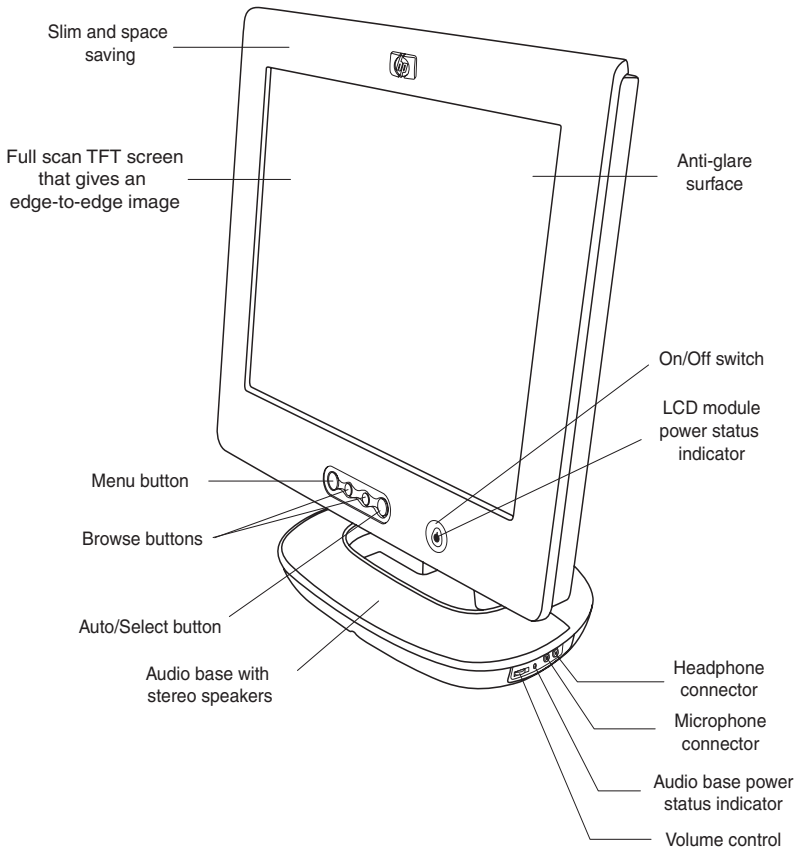

The HP f70 monitor is a liquid crystal display (LCD) 17-inch, high resolution, multi-synchronous color monitor. *Multi-synchronous* means that the monitor can be used with a range of video modes. It is optimized for use with all HP computers.

The HP f70 monitor has the following features:

- A 17-inch LCD; thin film transistor (TFT) with an anti-glare surface
- Support of video modes up to 1280 x 1024 at a 75 Hz refresh rate
- Analog/Digital interface: a VGA (analog) and a DVI-D (digital) connector enables connection to two computers at the same time (optional)
- True color (16.7 million colors)
- Auto-adjustment of display position, clock, and phase for the VGA interface
- Audio base with Polk Audio active stereo speakers
- All-in-one audio and microphone cable
- An onscreen display (OSD) manager that allows you to adjust all settings through onscreen menus
- Power-management system (VESA² standard) controlled from suitably equipped HP computers to automatically reduce the power consumption of the monitor

NOTE: *As an ENERGY STAR partner, HP has determined that this product meets ENERGY STAR guidelines for energy efficiency.*

- Plug and Play capability (compliant with VESA DDC standard, version 3, revision 1 at the levels DDC1, DDC/2B, DDC/C1, version 1) that enables the monitor to identify itself to suitably equipped HP computers
- Slot for security lock

2. VESA is the Video Electronics Standards Association.

Unpacking the Monitor

Check for the following items. If they are missing or damaged, consult your retailer immediately.

- 1 liquid crystal display (LCD)
- 1 power cord
- 1 DC adapter with an attached DC cable
- 1 video cable (VGA)
- 1 video cable (DVI-D) (select models only)
- 1 *Quick User's Guide*
- 1 warranty booklet
- 1 CD-ROM disc

Setting Up the Monitor

Place the monitor on a flat, sturdy surface. Ensure that the operating site is free from excessive heat and moisture. For best performance, make sure nothing is resting on the monitor.



WARNING: Before you connect any cables or install the HP monitor, refer to the safety instructions at the beginning of this manual. Refer also to the documentation that came with the computer to ensure this equipment is correctly installed.

Connecting two computers to the monitor

The LCD monitor has two video signal connectors on the rear panel: one analog (VGA) and one digital (DVI-D). This allows you to connect the monitor to two computers at the same time.

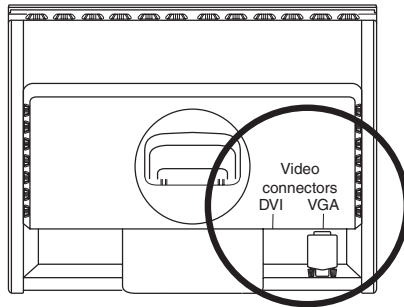

When two computers are connected, you need to use the Input Priority setting on the onscreen display (OSD) to switch from one video signal to the other. See "Input Priority" on page 33. The LCD must be set to one signal or the other to operate properly.

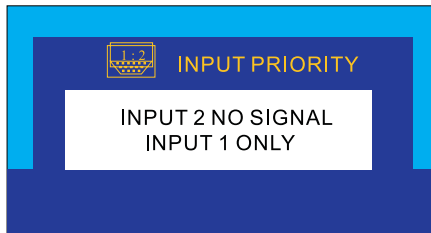

Connecting the cables to the f50 monitor

Look at the following diagram and follow the steps listed below to connect the cables to the f50 15-inch LCD monitor.

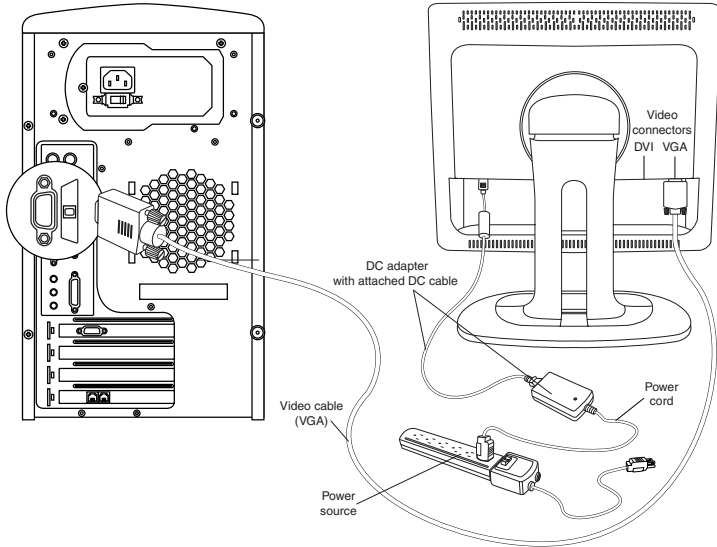

CAUTION: This monitor is equipped with an auto-sensing power supply for voltage ranges 100–240 V~, 50/60 Hz. Use the monitor with the supplied DC adapter only.

To connect the cables to the f50 monitor:

- 1 Make sure the computer is turned off.
- 2 Plug the video cable into the correct video connector (VGA or DVI-D) on the back of the monitor and into the corresponding video connector on the computer. Secure the cable by tightening the thumbscrews.

VGA cable →	VGA connector
DVI-D cable →	DVI-D connector

NOTE: *The f50 monitor comes with both a VGA and a DVI-D connector. Some models come with a VGA cable, and others come with a DVI-D cable as well. Using both video connectors, you can connect this monitor to two computers at the same time. You may need to purchase the DVI-D cable.*

- 3 Plug the DC adapter cable into the connector on the back of the monitor.
- 4 Plug the power cord into the DC adapter and into the main power source.
- 5 Turn on the main power source (for example, a surge protector), and then turn on the power switch for both the computer and the monitor.

To disconnect the cables from the f50 monitor:

- 1 Turn off the power switch for the monitor and the computer and then turn off the main power source.
- 2 Disconnect the power cord from the main power source and from the DC adapter cable.
- 3 Disconnect the DC adapter cable from the connector at the back of the monitor.
- 4 Unscrew the thumbscrews on the video cable(s) and disconnect the video cable(s).

Connecting the cables to the f70 monitor

Look at the following diagram and follow the steps listed below to connect the cables to the f70 17-inch LCD monitor.



CAUTION: This monitor is equipped with an auto-sensing power supply for voltage ranges 100–240 V~, 50/60 Hz. Use the monitor with the supplied DC adapter only.

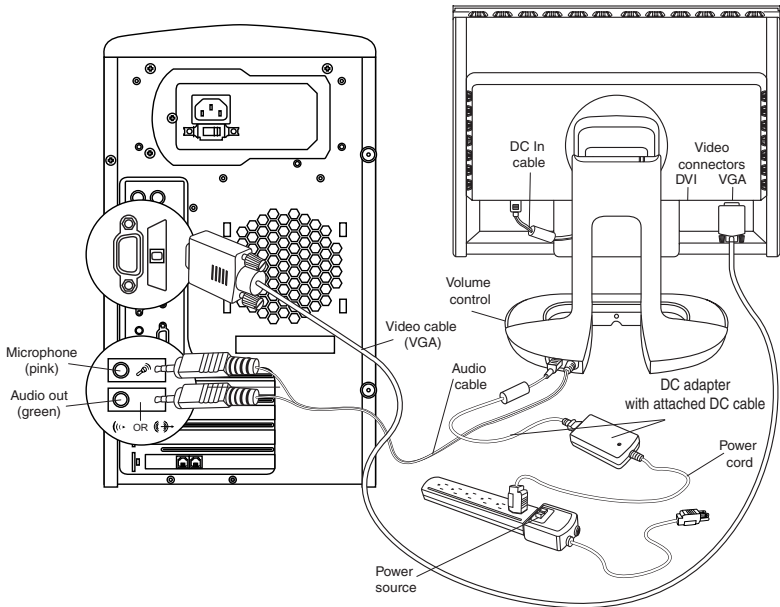



To connect the cables to the f70 monitor:

- 1 Make sure the computer is turned off.
- 2 Plug the video cable into the correct video connector (VGA or DVI-D) on the back of the monitor and into the corresponding video connector on the computer. Secure the cable by tightening the thumbscrews.

VGA cable →	VGA connector
DVI-D cable →	DVI-D connector

NOTE: *The f70 monitor comes with both a VGA and a DVI-D connector. Some models come with a VGA cable, and others come with a DVI-D cable as well. Using both video connectors, you can connect this monitor to two computers at the same time. You may need to purchase the DVI-D cable.*

- 3 Plug the audio cable into the correct connectors on the computer. Connect the green plug to the Audio Out connector and the pink plug to the Microphone connector on the computer.

green → Audio Out connector	
pink → Microphone connector	
Speaker Out connector	



CAUTION: **Do not connect the audio cable to the Speaker Out connector on the computer: the audio system of the monitor could be damaged. The audio cable must be connected to the Audio Out connector. HP recommends you keep the audio cable connected to the Audio Out connector on the computer at all times when using the f70 monitor.**

- 4 Plug the DC adapter cable into the connector at the rear of the monitor base.
- 5 Plug the power cord into the DC adapter.
- 6 Make sure the DC In cable is connected from the back of the monitor column to the back of the LCD panel. This cable should always be connected.
- 7 Make sure the volume is turned to the minimum setting on both the audio base and on the keyboard (if the keyboard has a volume control feature).

NOTE: *For the best performance and sound range of the f70 monitor, use the keyboard for the primary volume control and use the audio base as a secondary volume control.*

- 8 Turn on the main power source (for example, a surge protector), and then turn on the power switch for both the computer and the monitor.

NOTE: *The audio base is always on when the monitor is connected to a power source, even when the computer and the LCD panel are turned off. To see if the monitor is receiving power, check the power status indicator (LED) on the side of the audio base and check the light indicator on the front of the LCD panel.*

To disconnect the cables to the f70 monitor:

- 1 Turn off the power switch for the monitor and the computer, and then turn off the main power source.
- 2 Disconnect the power cord from the main power source and the DC adapter cable.
- 3 Disconnect the DC adapter cable from the connector at the rear of the monitor base.
- 4 Disconnect the audio cable from the computer connectors.
- 5 Unscrew the thumbscrews on the video cable(s) and disconnect the video cable(s).

Connecting the speakers to the f70 monitor

The f70 monitor comes with two built-in stereo speakers in the audio base. If you bought the monitor with an HP Pavilion home PC, you will have two sets of speakers: an external set shipped with the computer, and a built-in set that is part of the monitor.

The external speakers of the computer connect to a Speaker Out connector identified on the set up poster for the computer. These speakers will provide the best sound for most HP Pavilions.

If you want to use the built-in monitor speakers, you must connect them to a Line Out or an Audio Out connector on the back of the computer. Use the audio cable provided for connecting the built-in monitor speakers and the microphone to the computer; see step 3 in "Connecting the cables to the f70 monitor" on page 14.

If the computer does not have a Line Out or Audio Out connector, you can purchase a sound card with a Line Out connector to use the internal monitor speakers.

If you are not sure which connector you have and the sound quality is poor, make sure the external PC speakers are connected to the Speaker Out connector and not the Audio Out connector. Make sure the audio cable from the monitor is not connected to the Speaker Out connector on the computer.

Securing the f70 monitor

The f70 monitor can be secured to a desk or to any other fixed object, using a Kensington lock security cable. The cable can be attached to a slot located on the rear of the monitor.

NOTE: *The Kensington lock is not an HP accessory. It cannot be ordered from HP. Contact your retailer for more information.*

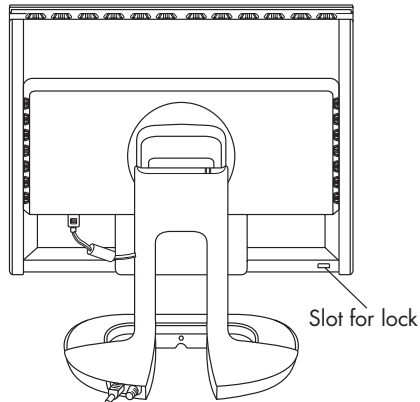



To secure the monitor:

- 1 Insert the lock in the slot located on the rear of the monitor.
- 2 Turn the key to lock the cable to the monitor.
- 3 Remove the key and store it in a safe place.

Connecting additional devices to the f70 monitor

The following diagram shows additional devices that can be connected to the monitor. On the side of the audio base, the f70 monitor has one headphone connector and one microphone connector. You can use these connectors to connect various compatible devices.

Headphone connector	
Microphone connector	

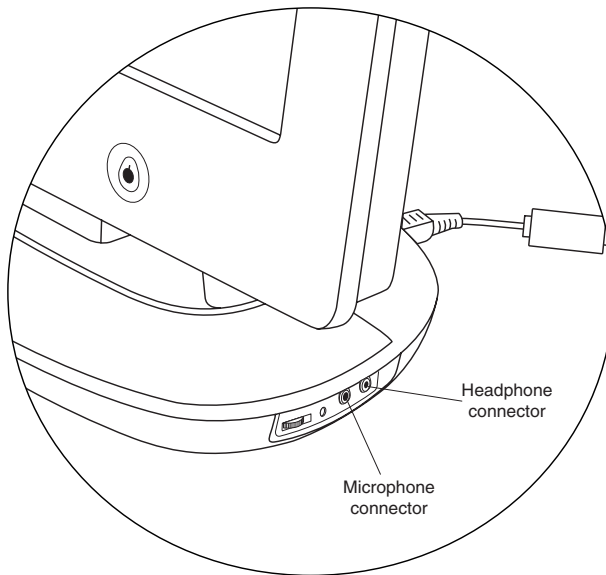

How to Install the Drivers

The HP monitor comes with driver software that allows you to take advantage of the Plug and Play feature of the Windows® Me, Windows 2000, or Windows XP operating system. This software enables the computer to communicate with the monitor and use all the monitor features. Without this software, the monitor settings and display images will not be correct.

NOTE: *HP computers may ship with the Plug and Play drivers preinstalled. If you have an older computer, these drivers may not be preinstalled and you may need to install the drivers from the CD-ROM disc that came with the monitor.*

You can also download the latest version of a driver from the HP Monitors Support Web site at:
<http://www.hp.com/go/monitorsupport/>

Windows 2000 Users

NOTE: *The procedure for installing the driver for your operating system may vary.*

To install the driver for the f50 or f70 monitor:

- 1 Click **Start**, select **Settings**, and then click **Control Panel**.
- 2 Double-click **Display**.
- 3 Click the **Settings** tab.
- 4 Click **Advanced Properties** or **Advanced**, and select the **Monitor** tab.
- 5 Click **Properties**.
- 6 Click the **Driver** tab.
- 7 Click **Update Driver** and click **Next**.
- 8 Select the recommended option and then click **Next**.
- 9 Select the **Specify a Location** box.
- 10 Find and open the **f50.inf** (f50 15-inch) or the **f70.inf** (f70 17-inch) file on the CD-ROM disc in the Drivers directory, and click **OK**.
- 11 Click **Next** to install the selected monitor.

Windows Me Users

NOTE: *The procedure for installing the driver for your operating system may vary.*

To install the driver for the f50 or f70 monitor:

- 1 Click **Start**, select **Settings**, and then click **Control Panel**.
- 2 Click **Display**.
- 3 Select the **Settings** tab.
- 4 Click the **Advanced** button.
- 5 Select the **Monitor** tab.
- 6 Click the **Change** button.
- 7 Select the **Specify a Location** box.
- 8 Find and open the **f50.inf** (f50 15-inch) or the **f70.inf** (f70 17-inch) file on the CD-ROM disc in the Drivers directory, and click **OK**.
- 9 Click **Next** to install the selected monitor.

Windows XP Users

NOTE: *The procedure for installing the driver for your operating system may vary.*

To install the driver for the f50 or f70 monitor:

- 1 Click **Start**.
- 2 Click **Control Panel**.
- 3 Click **Appearance and Themes**.
- 4 Click **Display**.
- 5 Select the **Settings** tab.
- 6 Click the **Advanced** button.
- 7 Select the **Monitor** tab.
- 8 Click **Properties**.
- 9 Select the **Driver** tab.
- 10 Click **Update Driver** and click **Next**.
- 11 Select the recommended option and then click **Next**.
- 12 Select the **Specify a Location** box.

13 Find and open the **f50.inf** (f50 15-inch) or the **f70.inf** (f70 17-inch) file on the CD-ROM disc in the Drivers directory, and click **OK**.

14 Click **Next** to install the selected monitor.

If the installation procedure of the monitor driver for the Windows 2000, Windows Me, or Windows XP operating system is different, or if you need more detailed installation information, please refer to the Microsoft Windows information that came with the computer.

Adjusting the Monitor

The monitor display has several adjustable settings which may need to be fine-tuned occasionally. Adjust the monitor:

- When the monitor is installed for the first time.
- If the resolution (number of pixels on the display) or refresh rate (vertical scan frequency rate) has been changed.
- If the graphic card has been changed.
- If the monitor is connected to a different computer.
- After using the Mode Recall function. See "To use Mode Recall" on page 31.

NOTE: *For best performance, it is recommended that you select a video mode of 1024 x 768 @ 60 Hz for the f50 monitor and 1280 x 1024 @ 60 Hz for the f70 monitor on the computer.*



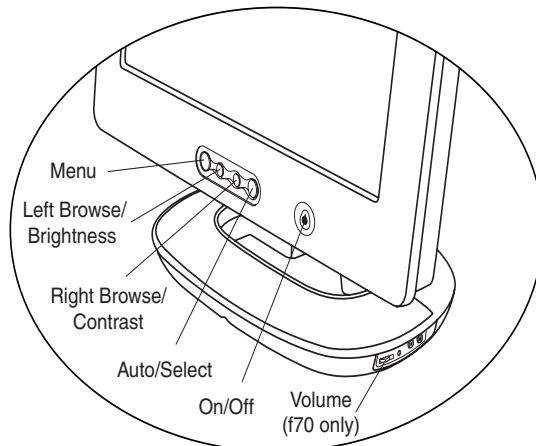

Using the monitor controls

There are five controls for the f50 monitor and six controls for the f70 monitor that perform the following operations:



NOTE: *The volume control is available only on the f70 monitor.*

Monitor control buttons

Control button/icon	Function when not in Display Manager	Function in Display Manager
	Menu: Opens and closes the Display Manager window	Closes setting screens and exits Display Manager
	Left Browse/Brightness: Shortcut to Brightness setting screen	Navigates through setting option icons and adjusts settings
	Right Browse/Contrast: Shortcut to Contrast setting screen	Navigates through setting option icons and adjusts settings
	Auto/Select: Performs an auto-adjustment which will optimize the image quality	Acts as an Enter (Select) key to select setting screen options
On/Off	On/Off: Turns the monitor on or off	Turns the monitor on or off
Volume control	Volume control*: Adjusts volume setting (f70 only)	Adjusts volume setting

***NOTE:** For the best performance and sound range of the f70 monitor, use the keyboard for the primary volume control and use the audio base as a secondary volume control.

Auto-Adjustment function

You can easily optimize the screen performance for the VGA interface by using the Auto button and the auto-adjustment pattern on the CD-ROM disc provided.

- 1 Insert the provided CD-ROM disc into the computer. Run the program D:\F50.exe or D:\F70.exe to display a pattern used for setup.
- 2 Press the Auto button to produce a stable, centered image.

The optimizer utility on the CD-ROM contains the drivers for Windows Me, Windows 2000, or Windows XP. For the f50 monitor, use the D:\Drivers\f50.inf file. For the f70 monitor, use the D:\Drivers\f70.inf file.

Using the Monitor

Using Display Manager

The monitor comes pre-configured to provide the best viewing image. However, you can fine-tune the display using Display Manager. The monitor has control buttons that you can use to open Display Manager to select and adjust display settings.

To adjust display settings:

- 1 Press the Menu button to open Display Manager.
- 2 Press a Browse button to navigate through the setting option icons; see the following setting options table.
- 3 When the menu option you want is selected, press the Select button to open the setting screen for that option.
- 4 Adjust the setting using the onscreen instructions that follow.
- 5 To exit Display Manager, press the Menu button.

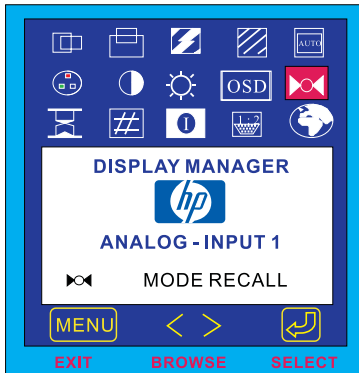

Display Manager screen
in analog mode



Display Manager screen
in digital mode

Setting Options

The icons at the top of the Display Manager window represent the different setting options, shown in the following table:

Icon	Setting option	Setting description
	Horizontal Position*	Adjusts the horizontal position of the screen image.
	Vertical Position*	Adjusts the vertical position of the screen image.
	Clock*	Adjusts the frequency of the pixel clock to minimize vertical bars.
	Phase*	Adjusts the phase value to minimize horizontal bars.
	Auto Config*	Adjusts the main settings and produces a stable, centered image.
	Color	Adjusts the tint of white, and the red, green, and blue (RGB) mix for colors.
	Contrast	Adjusts the difference between the light and dark areas.
	Brightness	Adjusts the brightness.
	OSD Manager (OSD stands for onscreen display)	Adjusts the position, timeout, and notification features of the Display Manager window.
	Mode Recall	Resets the display to original factory settings for color, brightness, phase, and clock.
	Backlight Info	Shows the status of the light behind the panel.
	Serial Number	Shows the serial number of the display.
	Mode Info	Shows the current resolution and refresh rate; shows if you're in analog or digital mode; and shows how many user settings have been adjusted.
	Input Priority	Sets which video input is active: analog or digital. Shows status of the video input that is active.
	Languages	Shows the language of the OSD window.

***NOTE:** *Horizontal Position, Vertical Position, Clock, Phase, and Auto Config settings do not need to be adjusted for displays operating in digital mode; therefore these icons do not appear in digital mode.*

Horizontal Position, Vertical Position, Clock, Phase, Contrast, or Brightness settings

To change Horizontal Position, Vertical Position, Clock, Phase, Contrast or Brightness settings:

- 1 Open the setting screen you want to adjust. See “Using Display Manager” on page 24.



- 2 Press the Browse buttons to adjust the setting. The setting is automatically saved as you adjust it.

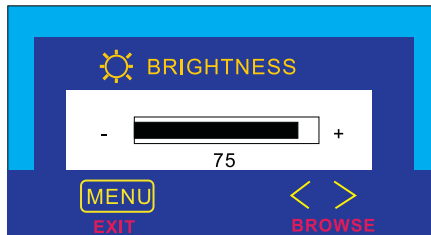

- 3 Press the Menu button to exit the setting screen.
 - In the Horizontal Position screen, pressing the left Browse button moves the horizontal position to the left, and pressing the right Browse button moves the horizontal position to the right.
 - In the Vertical Position screen, pressing the left Browse button moves the vertical position down, and pressing the right Browse button moves the vertical position up.
 - In the Clock screen, pressing the left Browse button sets the clock to an earlier time, and pressing the right Browse button sets the clock to a later time.
 - In the Phase screen, pressing the left Browse button decreases phase setting values, and pressing the right Browse button increases phase setting values.
 - In the Contrast screen, pressing the left Browse button decreases the contrast, and pressing the right Browse button increases the contrast.
 - In the Brightness screen, pressing the left Browse button decreases the brightness, and pressing the right Browse button increases the brightness.

Auto Config settings

With Auto Config you can reset Horizontal Position, Vertical Position, Clock, and Phase to optimize the image quality. When using this option, please view a full Windows screen, such as Windows Explorer, or use the test pattern provided on the CD before pressing the Select button on the Auto Config menu. These test pattern files are named F50.exe and F70.exe.

To change settings with Auto Config:

- 1 Open the Auto Config setting screen. See "Using Display Manager" on page 24. A window with a red bar appears.

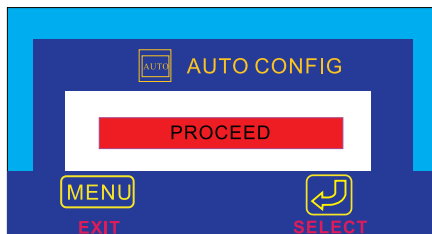

- 2 Press the Select button to proceed with the reset, or press the Menu button to exit without resetting.
- 3 If you reset the settings, press the Menu button to exit the setting screen.

Color settings

To change Color settings:

Open the Color setting screen. See "Using Display Manager" on page 24. Four options appear: Bluish, White, Reddish, and User. Bluish, White, and Reddish refer to tints of white. This setting lets you manually adjust the red, green, and blue (RGB) mix for color generation.

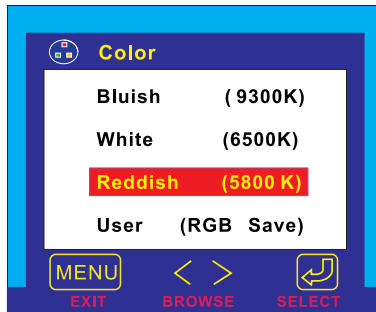

To adjust tints of white:

- 1 Press the Browse buttons to select a tint of white.
- 2 Press the Menu button to save the tint setting and exit the setting screen.

To adjust User Color:

- 1 Press the Browse buttons until User is selected.
- 2 Press the Select button to open the User Color window.

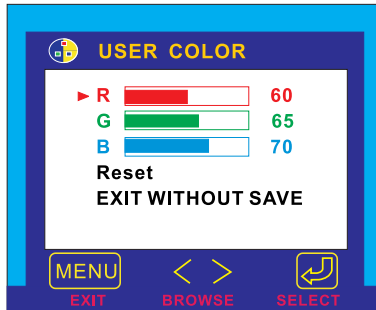

- 3 Press the Browse buttons to select the color you want to adjust.
- 4 Press the Select button to activate the adjustable setting for the color.
- 5 Press the Browse buttons to change the color value. The value is automatically saved as you change it.
- 6 Press the Menu key to exit the setting screen.

After you change a color value, you can reset the values to the original factory color settings by selecting **Reset** and pressing the Menu key.

You can choose to keep the color values as they were before any adjustments were made by selecting **EXIT WITHOUT SAVE** and pressing the Menu key.

OSD settings

To change OSD settings:

- 1 Open the OSD setting screen. See “Using Display Manager” on page 24. Five options appear: Protected OSD, OSD Timeout, Inform On/Off, H Position, and V Position.

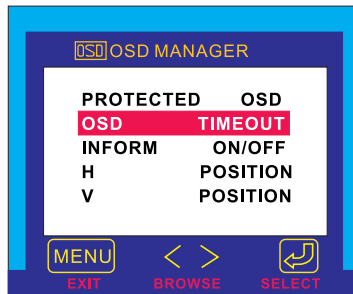

- 2 Press the Browse buttons to select the option you want to adjust.
- 3 Press the Select button to display its setting screen.

NOTE: *Protected OSD is not available for use.*

To adjust OSD Timeout:

You can set the OSD (Display Manager) screen to turn off automatically when you are not using it.

- 1 Press the Browse buttons to select how long the Display Manager screen appears before automatically turning off. The setting is automatically saved as you adjust it.
- 2 Press the Menu button to exit the setting screen.

To adjust Inform On/Off:

Turning Inform on displays the chosen resolution and refresh rate for three seconds, whenever you change them. Turning Inform off prevents this information from being displayed.

- 1 Press the Browse buttons to select On or Off. The setting is automatically saved as you adjust it.
- 2 Press the Menu button to exit the setting screen.

To adjust OSD H Position:

You can adjust the horizontal position of the OSD (Display Manager) screen.

- 1 Press the Browse buttons to position the OSD screen. The setting is automatically saved as you adjust it.
- 2 When the screen is in the horizontal position you want, press the Menu button to exit the setting screen.

To adjust OSD V Position:

You can adjust the vertical position of the OSD (Display Manager) screen.

- 1 Press the Browse buttons to position the OSD screen. The setting is automatically saved as you adjust it.
- 2 When the screen is in the vertical position you want, press the Menu button to exit the setting screen.

Mode Recall

Using Mode Recall restores original factory settings for Color, Brightness, Phase, and Clock. This will re-establish default color settings for the best possible brightness.

To use Mode Recall:

- 1 Open the Mode Recall setting screen. See “Using Display Manager” on page 24. A window with a red bar appears.

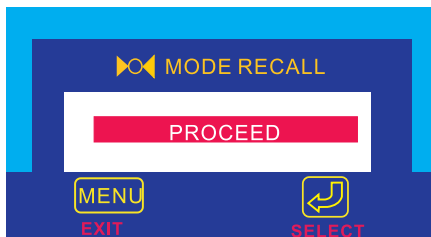

- 2 Press the Select button to proceed with Mode Recall, or press the Menu button to exit without resetting.
- 3 If you reset with Mode Recall, press the Menu button to exit the setting screen.

Backlight Info

The Backlight Info window shows the elapsed time of usage for the light behind the display screen. The expected lifespan of the backlight is approximately 30,000 to 40,000 hours. At some point after the maximum usage time of the backlight has been exceeded, you may notice a decrease in brightness of up to 50%. At this point, the backlight needs to be replaced to restore full brightness.



CAUTION: The backlight can be replaced only by a trained technician. Please contact the HP Support Center for assistance. Do not attempt to replace the light yourself.

NOTE: Do not use a screen saver with the LCD monitor, as the backlight will be used. It is recommended that you enable an automatic power saving mode, or switch off the monitor when not in use.

To view Backlight Info:

- 1 Open the Backlight Info setting screen. See "Using Display Manager" on page 24. The elapsed time is displayed.
- 2 Press the Menu button to exit the setting screen.

Serial Number

You may need to provide the display serial number to HP Support technicians to help them serve you better during a Support call.

To view a Serial Number:

- 1 Open the Serial Number setting screen. See "Using Display Manager" on page 24. The serial number is displayed.
- 2 Press the Menu button to exit the setting screen.

Mode Info

The Mode Info screen shows whether the current video input mode is analog (1) or digital (2); shows the current resolution and refresh rate; and shows how many User settings you have changed, and how many preset settings have not been changed.

To view Mode Info:

- 1 Open the Mode Info setting screen. See "Using Display Manager" on page 24. The Video Input mode, the resolution and refresh rate, and the number of Preset and User values are displayed.
- 2 Select the Preset or User values with the Browse buttons.
- 3 Press the Select button. The Preset or User mode information screen is displayed.
- 4 Press the Menu button to exit the setting screen.

Input Priority

You can use this setting to switch between the two video inputs, analog and digital. The default active video input is analog (1). If you are connecting a PC to the digital input (2), you need to change the input priority in the Input Priority screen.

NOTE: *You only need to set the digital input when you connect two PCs to the monitor.*

To set Input Priority:

- 1 Open the Mode Info setting screen. See "Using Display Manager" on page 24.
- 2 Press the Browse buttons to switch between Input 1 (analog) and Input 2 (digital).
- 3 Press the Select button to confirm the new setting. A confirmation screen is displayed.
- 4 Press the Menu button to exit the setting screen.

Language of Display Manager

You can choose to view Display Manager in English, German, French, Italian, or Spanish.

To change the language of Display Manager:

- 1 Open the Languages setting screen. See "Using Display Manager" on page 24.
- 2 Press the Browse buttons to choose the language you would like. The setting is automatically saved.
- 3 Press the Menu button to exit the setting screen.

Troubleshooting

If you are having trouble with the monitor, these tips may help you solve the problem. Try the following steps before calling HP.

If you find:

No picture and the light indicator on the front of the LCD panel is off:

- Check that the monitor is turned on.
- Check that the power cord is properly connected.
- Check the electrical outlet.
- Connect the monitor to another computer to determine if there is a problem with the computer rather than with the monitor.

No picture and the light indicator on the front of the LCD panel is on:

- Check that the computer is turned on.
- Check that the monitor is not in power-saving mode.
- Adjust the Contrast and Brightness through the onscreen display or the control buttons.
- Check that the video cable has no bent pins.
- Connect the monitor to another computer to determine if there is a problem with the computer rather than the monitor.

Picture is fuzzy:

- Adjust the monitor using the Auto-Adjustment function. See "Auto-Adjustment function" on page 23.
- If you are running the Windows Me, Windows 2000, or Windows XP operating system, install the Plug and Play driver (.inf file). See "How to Install the Drivers" on page 19.
- For the f50 monitor, change the resolution to the recommended resolution of 1024 x 768 @ 60 Hz.
- For the f70 monitor, change the resolution to the recommended resolution of 1280 x 1024 @ 60 Hz.

Pixels are missing:

- See "LCD Monitor Quality and Pixel Policy for the f50 Monitor" on page 36.
- See "LCD Monitor Quality and Pixel Policy for the f70 Monitor" on page 37.

Colors are not pure:

- Check that the video cable has no bent pins and is firmly attached to both the computer and monitor video connectors.
- Restore the original factory colors setting. See "To use Mode Recall" on page 31.
- Adjust the RGB (red, green, and blue) colors. See "To change Color settings" on page 28.

Picture is not centered:

- Adjust the monitor using the Auto-Adjustment function. See "Auto-Adjustment function" on page 23.

No sound (f70 monitor only):

- Check to see that the power status indicator (LED) on the side of the audio base is turned on.
- Make sure the main power supply is turned on.
- Check to see if the audio cable is plugged in properly.
- Adjust the volume setting on the audio base and the keyboard. Make sure the Mute setting on the keyboard and in the Volume Controls of the computer is turned off.

LCD Monitor Quality and Pixel Policy for f50 Monitor

f50 15-inch monitor

The HP f50 TFT monitor uses high-precision technology, manufactured according to HP standards, to guarantee trouble-free performance. Nevertheless, the display may have cosmetic imperfections that appear as small bright or dark spots. This is common to all LCD displays used in products supplied by all vendors and is not specific to the HP D5063 LCD. These imperfections are caused by one or more defective pixels or sub-pixels.

- A pixel consists of one red, one green, and one blue sub-pixel.
- A defective whole pixel is always on (a bright spot on a dark background), or it is always off (a dark spot on a bright background). The first is the more visible of the two.
- A defective sub-pixel (dot defect) is less visible than a defective whole pixel and is small and only visible on a specific background.

The HP D5063 display does not have more than:

- 10 total dot defects.
- 10 defective full pixels.
- 10 defective red sub-pixels.
- 4 defective green sub-pixels (green is most visible).
- 10 defective blue sub-pixels.
- No more than two adjacent (less than 2.5 mm edge-to-edge) and defective pixels.
- No more than two pairs of two adjacent defective pixels.

To locate defective pixels, the monitor should be viewed under normal operating conditions, in normal operating mode at a supported resolution and refresh rate, from a distance of approximately 50 cm (16 in.).

HP expects that, over time, the industry will continue to improve its ability to produce LCDs with fewer cosmetic imperfections and HP will adjust guidelines as improvements are made.

LCD Monitor Quality and Pixel Policy for f70 Monitor

f70 17-inch monitor

The HP f70 TFT monitor uses high-precision technology, manufactured according to HP standards, to guarantee trouble-free performance. Nevertheless, the display may have cosmetic imperfections that appear as small bright or dark spots. This is common to all LCD displays used in products supplied by all vendors and is not specific to the HP D5064 displays. These imperfections are caused by one or more defective pixels or sub-pixels.

- A pixel consists of one red, one green, and one blue sub-pixel.
- A defective whole pixel is always on (a bright spot on a dark background), or it is always off (a dark spot on a bright background). The first is the more visible of the two.
- A defective sub-pixel (dot defect) is less visible than a defective whole pixel and is small and only visible on a specific background.

The HP D5064 display does not have more than:

- 15 total dot defects.
- 10 defective full pixels.
- 10 defective red sub-pixels.
- 4 defective green sub-pixels (green is most visible).
- 10 defective blue sub-pixels.
- No more than two adjacent (less than 2.5 mm edge-to-edge) and defective pixels.
- No more than two pairs of two adjacent defective pixels.

To locate defective pixels, the monitor should be viewed under normal operating conditions and in normal operating mode at a supported resolution and refresh rate, from a distance of approximately 50 cm (16 in.).

HP expects that, over time, the industry will continue to improve its ability to produce displays with fewer cosmetic imperfections and HP will adjust guidelines as improvements are made.

Technical Specifications for the f50 Monitor

f50 15-inch monitor

Liquid Crystal Display (LCD)	Display Size	15-in. (38 cm) diagonal and viewable image
	Type	TFT liquid crystal display
Input Signal	Video	0.7 V (0,7 V) p-p analog RGB
	Synchronization	Separated H/V (TTL level)
Interface	Input Connector	Analog R, G, B separate H,V sync. 15-pin mini D-SUB + Digital DVI-D
Scanning Frequency	Horizontal	30–60 kHz
	Vertical	56–75 Hz
Max. Resolution (H x V)	1024 x 768 @ 75 Hz	
Recommended Resolution (H x V)	1024 x 768 @ 60 Hz	
Power Source	AC/DC Adapter	Input Rating: 100–240 V~, 2 A max Output Rating: 12 V ---, 4.16 A (4,16 A) Frequency: 50/60 Hz Power Consumption: less than 36 W in operating mode
Operating Environment	Temperature	5° C to 40° C
	Humidity	20% RH through 85% RH (without condensation)
Storage Environment	Temperature	–20° C to 60° C
	Humidity	8% RH through 85% RH (without condensation)
Dimensions	H x W x D With stand: 400 x 365 x 215 mm (15.7 x 14.4 x 8.5 in)	
Weight	With stand: 4.8 Kg (10.6 lbs)	
Tilt Stand	Tilt Angle: Down 5, up 25 degrees	

Technical Specifications for the f70 Monitor

f70 17-inch monitor

Liquid Crystal Display (LCD)	Display Size	17-in. (43 cm) diagonal and viewable image
	Type	TFT liquid crystal display
Input Signal	Video	0.7 Vp-p analog RGB
	Synchronization	Separated H/V (TTL level)
Interface	Input Connector	15-pin D-SUB (Analog) DVI-D (Digital)
	Scanning Frequency	Horizontal Vertical
Max. Resolution (H x V)	1280 x 1024 @ 75 Hz	
Recommended Resolution (H x V)	1280 x 1024 @ 60 Hz	
Power Source	AC/DC Adapter	Input Rating: 100–240 V~, 2 A max Output Rating: 12 V ---, 4.16 A (4,16 A) Frequency: 50/60 Hz Power Consumption: less than 75 W in operating mode
Operating Environment	Temperature	10° C to 35° C
	Humidity	20% RH through 80% RH (without condensation)
Storage Environment	Temperature	-10° C to 60° C
	Humidity	8% RH through 85% RH (without condensation)
Dimensions	H x W x D With standard stand: 468 x 419 x 206 mm 18.4 x 16.5 x 8.1 in.	
Weight	With standard stand: 6.1 Kg (13.42 lbs)	
Tilt Stand	Tilt Angle: Down 5, up 25 degrees	
Security Lock	Monitor cabinet is provided with a slot allowing the use of Kensington lock device	

HP f70 Audio System Performance Specifications

Amplifier Performance	Output power per channel into 8 ohm loads, both channels driven, 1 kHz, with 12 V _{DC} regulated supply:	> 3 W @ <5% THD
	Signal-to-Noise ratio, grounded inputs, maximum gain, A-weighted, referred to full output:	> 85dB
	Crosstalk, 22 kHz bandwidth, 1 kHz, shorted inputs, at maximum gain:	better than -50dB
	Nominal THD below 2 W, 1 kHz, 30 kHz measurement bandwidth:	< 0.1% (0,1%)
	Sensitivity (input voltage to produce full output):	-400 mV rms @ 1 kHz
	Input impedance:	10k
Storage Performance	Frequency response:	150 Hz–23 kHz, -3 dB @ 230 Hz and 22 kHz
	Maximum SPL:	@ 0.5 m (0,5 m): 99 dB C-weighted (calculated)
	Idle current draw:	40 mA

NOTE: *The purpose of this document is to specify the nominal electrical and acoustical performance of the audio system for the HP Pavilion f70 flat panel LCD computer display.*

Care and Cleaning

To maximize the screen lifespan of this product and to prevent damage to the liquid crystal display, it is recommended that you:

- Do not let liquid get on or into the monitor.
- Do not store or use the monitor in locations exposed to heat, direct sunlight, or extreme cold.
- Do not store or use the monitor in a dusty environment or in locations exposed to high humidity.
- Do not press sharp or pointed objects against the monitor.
- Avoid touching or pressing the screen of the monitor.
- Avoid setting contrast and brightness to their maximum levels for prolonged periods.
- Turn off the monitor when not in use.
- Do not place anything on or against the audio base (f70 17-inch monitor only).
- Use a soft brush or cloth to clean the audio base (f70 17-inch monitor only).
- Clean the screen with isopropyl alcohol or ethyl alcohol diluted with water (1:1) to prevent damage to the screen's anti-glare coating.

To clean the screen:

- 1 Turn off the monitor and remove the power plug (pull the plug, not the cable).
- 2 Soak a soft gauze cloth with isopropyl alcohol or ethyl alcohol diluted with water (1:1) and gently wipe the surface of the monitor. Do not dust it or wipe it with a cloth dampened with pure water.
- 3 Dry with a clean, soft cotton cloth.



CAUTION: Never use pure water to clean the LCD screen. Do not use cleaning solutions containing fluoride, acids, or alkalis. Do not use ketone substances such as acetone or solvents such as xylene or toluene to clean the monitor. Do not use benzene, thinner, ammonia, or any volatile substance to clean the monitor's screen or cabinet. These chemicals may damage the monitor.

Environmental Information

HP has a strong commitment to the environment. The HP monitor has been designed with respect for the environment as much as possible.

HP can also take back your old monitor for recycling when it reaches the end of its useful life.

HP has a product take-back program in several countries. The collected equipment is sent to one of HP's recycling facilities in Europe or the USA. As many parts as possible are reused. The remainder is recycled. Special care is taken with batteries and other potentially toxic substances; these are reduced to harmless components through a special chemical process. If you require more details about HP's product take-back program, contact your dealer or your nearest HP sales office.

Regulatory Information

DECLARATION OF CONFORMITY

According to ISO/IEC Guide 22 and CEN/CENELEC EN 45014

Manufacturer's name: HEWLETT-PACKARD France
Manufacturer's address: 5 Avenue Raymond Chanas-Eybens
38053 GRENOBLE Cedex 09 - FRANCE

Declares that the products :

Product Name	HP 15" (LCD) Color Monitor	HP 17" (LCD) Color Monitor
Model Number	D5063**	D5064**

(* can be any alphanumerical character)

Conform to the following Product Specifications :

§ **SAFETY** - International: IEC 60950:1991 +A1 +A2 +A3 +A4 / GB4943-1995.
- Europe : EN 60950:1992 +A1 +A2 +A3 +A4 +A11.

§ **ELECTRO-MAGNETIC COMPATIBILITY**
- CISPR22:1997 / EN55022:1998 Class B
- CISPR24:1997 / EN55024:1998
- IEC 61000-3-3:1994 / EN61000-3-3:1995
- GB9254-1998
- FCC Title 47 CFR, Part 15 Class B ¹⁾
- ICES-003, Issue 3
- VCCI-B
- AS/NZ 3548:1995

Products bearing the CE marking⁽²⁾ also comply with:

- IEC 61000-3-2:1995 / EN 61000-3-2:1995. + A14

Those products comply with the requirements of the following Directives and carry the CE marking accordingly: EMC Directive 89/336/EEC and Low Voltage Directive 73/23/EEC, both amended by the Directive 93/68/EEC.

- ¹⁾ This device complies with Part 15 of the FCC rules. Operation is subject to the following two conditions
(1) This device may not cause harmful interference, and
(2) This device must accept any interference received, including interference that may cause undesired operation.
- ²⁾ All products sold in the European Economic Area (EEA) bear the CE marking.

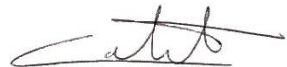

Grenoble
July 2001

Didier CABARET
Quality Manager

For Compliance Information ONLY, contact :

USA contact : Hewlett Packard Company, Corporate Product Regulations Manager 3000 Hanover Street,
Palo Alto, CA 94304. (Phone (+1) (650) 857-1501)

For Compliance Information ONLY, contact:

USA contact: Hewlett-Packard Company
Corporate Product Regulations Manager
3000 Hanover Street
Palo Alto, CA 94304
Phone : (+1) (650) 857-1501

Notice for the USA: FCC Class B Statement

Federal Communications Commission Radio Frequency Interference Statement Warning:

This equipment has been tested and found to comply with the limits for a Class B digital device, pursuant to Part 15 of the FCC Rules. These limits are designed to provide reasonable protection against harmful interference in a residential installation. This equipment generates, uses, and can radiate radio frequency energy and, if not installed and used in accordance with the instructions, may cause harmful interference to radio communications. However, there is no guarantee that interference will not occur in a particular installation. If this equipment does cause harmful interference to radio or television reception, that can be determined by turning the equipment off and on, the user is encouraged to correct the interference by one or more of the following measures:

- Reorient or relocate the receiving antenna.
- Increase the distance between the equipment and the receiver.
- Connect the equipment to an outlet on a different circuit to the one the receiver is connected to.
- Consult your dealer or an experienced radio/TV technician for help.

Safety Warning for USA

If the power cord is not supplied with the monitor, select the proper power cord according to your national electric specifications.

- USA: use a UL listed type SVT detachable power cord.

Notice for Canada

This Class "B" digital apparatus complies with all requirements of the Canadian Interference-Causing Equipment Regulations (ICES.003).

Cet appareil numérique de la Classe B est conforme a la norme MB-003 du Canada.

MPRII Statement

The monitor complies with MPRII guidelines for upper limits of electrostatic and magnetic field emissions, from the Swedish National Board of Measurement and Testing.

Notice for Korea

사용자 안내문 (B급기기)
이 기기는 비업무용으로 전자파장해 검정을 받은
기기로서, 주거지역에서는 물론 모든 지역에서
사용할 수 있습니다.

Notice for Germany

Hinweis für Deutschland: Geräuschemission

Lärmangabe nach Maschinenlärmmverordnung — 3 GSGV
(Deutschland)

LpA < 70db am Arbeitsplatz normaler Betrieb nach
EN27779: 11.92

Notice for Japan (Class B)

この装置は、情報処理装置等電波障害自主規制協議会（VCCI）の基準
に基づくクラスB情報技術装置です。この装置は、家庭環境で使用すること
を目的としていますが、この装置がラジオやテレビジョン受信機に近接して
使用されると、受信障害を引き起こすことがあります。
取り扱い説明書に従って正しい取り扱いをして下さい。



TCO '99 (European Union Only)

Congratulations! You have just purchased a TCO '99 approved and labeled product! Your choice has provided you with a product developed for professional use. Your purchase has also contributed to reducing the burden on the environment and to the further development of environmentally adapted electronics products.

This product meets the requirements for the TCO '99 scheme which provides for an international environmental and quality labeling of personal computers. The labeling scheme was developed as a joint effort by the TCO (The Swedish Confederation of Professional Employees), Svenska Naturskyddsforeningen (The Swedish Society for Nature Conservation), Statens Energimyndighet (The Swedish National Energy Administration), and SEMKO AB.

The requirements cover a wide range of issues: environmental, ergonomic, usability, reduction of electric and magnetic fields, energy consumption and electrical safety.

Why do we have environmentally labeled computers?

In many countries, environmental labeling has become an established method for encouraging the adaptation of goods and services to the environment. The main problem, as far as computers and other electronics equipment are concerned, is that environmentally harmful substances are used both in the products and during their manufacture. Since it is not so far possible to satisfactorily recycle the majority of electronics equipment, most of these potentially damaging substances sooner or later enter nature.

There are also other characteristics of a computer, such as energy consumption levels, that are important from the viewpoints of both the work (internal) and natural (external) environments. Since all methods of electricity generation have a negative effect on the environment (for example, acidic and climate-influencing emissions, radioactive waste), it is vital to save energy. Electronics equipment in offices is often left running continuously and thereby consumes a lot of energy.

What does the environmental labeling involve?

The environmental demands have been developed by Svenska Naturskyddsforeningen (The Swedish Society for Nature Conservation). These demands impose restrictions on the presence and use of heavy metals, brominated and chlorinated flame retardants, CFCs (freons) and chlorinated solvents, among other things. The product must be prepared for recycling, and the manufacturer is obliged to have an environmental policy which must be adhered to in each country where the company implements its operational policy.

The energy requirements include a demand that the computer and/or monitor, after a certain period of inactivity, shall reduce its power consumption to a lower level in one or more stages. The length of time to reactivate the computer shall be reasonable for the user.

Below, you will find a brief summary of the environmental requirements met by this product. The complete environmental criteria document may be ordered from:

TCO Development
SE-114 94 Stockholm, Sweden

Fax: +46 8 782 92 07

Email (Internet): development@tco.se

Current information regarding TCO '99 approved and labeled products may also be obtained over the Internet, using the address:
<http://www.tco-info.com/>

Environmental requirements

Flame retardants:

Flame retardants are present in printed circuit boards, cables, wires, casings and housings. Their purpose is to prevent, or at least to delay, the spread of fire. Up to 30% of the plastic in a computer casing can consist of flame retardant substances. Most flame retardants contain bromine or chloride, and those flame retardants are chemically related to another group of environmental toxins, PCBs. Both the flame retardants containing bromine or chloride and the PCBs are suspected of giving rise to severe health effects, including reproductive damage in fish-eating birds and mammals, due to the bio-accumulative*¹ processes. Flame retardants have been found in human blood and researchers fear that disturbances in foetus development may occur.

The relevant TCO '99 demand requires that plastic components weighing more than 25 grams must not contain flame retardants with organically bound bromine or chlorine. Flame retardants are allowed in the printed circuit boards since no substitutes are available.

*Cadmium: *2**

Cadmium is present in rechargeable batteries and in the colour-generating layers of certain computer displays. Cadmium damages the nervous system and is toxic in high doses. The relevant TCO '99 requirement states that batteries, the colour-generating layers of display screens and the electrical or electronics components must not contain any cadmium.

*Mercury: *2**

Mercury is sometimes found in batteries, relays and switches. It damages the nervous system and is toxic in high doses. The relevant TCO '99 requirement states that batteries may not contain any mercury. It also demands that mercury is not present in any of the electrical or electronics components associated with the labeled unit. There is however one exception. Mercury is, for the time being, permitted in the back light system of flat panel monitors as there today is no commercially available alternative. TCO aims on removing this exception when a mercury free alternative is available.

CFCs (freons):

The relevant TCO '99 requirement states that neither CFCs nor HCFCs may be used during the manufacture and assembly of the product. CFCs (freons) are sometimes used for washing printed circuit boards. CFCs break down ozone and thereby damage the ozone layer in the stratosphere, causing increased reception on earth of ultraviolet light with e.g. increased risks of skin cancer (malignant melanoma) as a consequence.

*Lead: *2**

Lead can be found in picture tubes, display screens, solders and capacitors. Lead damages the nervous system and in higher doses, causes lead poisoning. The relevant TCO '99 requirement permits the inclusion of lead since no replacement has yet been developed.

*1 *Bio-accumulative is defined as substances which accumulate within living organisms.*

2 *Lead, Cadmium and Mercury are heavy metals which are Bio-accumulative.*

