

Fahrenheit

MD-1210CMX

**12.1" TFT-LCD DVD/SD/USB
COMBO MONITOR**

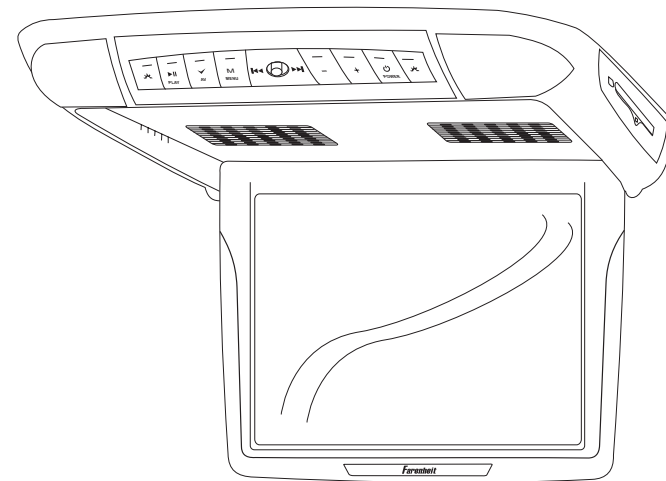

OWNER'S MANUAL

Contents

▪ Caution.....	4	Mute	24
▪ Features and Controls	6	Play or Pause	24
Monitor/DVD Player.....	6	Audio	24
Remote Control.....	8	Stop	25
▪ Power and Mode Selection	10	Arrows	25
Releasing The Monitor.....	10	Setup	25
Turning on The Monitor.....	10	Menu	25
Mute Function.....	10	Display.....	26
AV mode	11	Number Buttons.....	26
▪ Picture Control	12	Subtitle.....	27
Contrast/Brightness/Color/FM	12	Title	27
▪ DVD Setup	13	Slow	27
Setup Menu.....	13	Fast Reverse Searching	28
General Setup	14	Fast Forward Searching	28
TV Aspect Ratio.....	14	Previous.....	29
Angle Viewing	14	Next	29
OSD Language	14	Repeat A-B	29
Screen Saver	15	Repeat	30
Audio Setup.....	15	NTSC/PAL.....	30
Dolby Digital Setup.....	16	Angle	30
Equalizer Settings.....	16	PBC	31
Video Setup.....	18	Zoom	31
Quality	18	GO TO	31
Preferences Setup	21	▪ SD/USB Functions	32
TV Type	21	▪ Connection Diagram	33
PBC	21	▪ Installation	34
Audio	21	▪ Disc Information	35
Subtitle	21	▪ Troubleshooting.....	36
Disc Menu.....	22	▪ Specifications.....	37
Parental.....	22		
Default	22		
Password Setup	23		
Password Mode	23		
Password Change.....	23		
▪ DVD Functions.....	24		
Eject	24		
Vol+/Vol-.....	24		

Caution

Please read and observe all warnings and instructions in this manual and those marked on the unit. Retain this booklet for future reference.

There are two kinds of alarm symbols as follows:



WARNING

The lightning bolt with arrowhead inside in an equilateral triangle is intended to alert the user to the presence of " dangerous voltage " within the product's enclosure that may be of sufficient magnitude to constitute a risk of electric shock to people.



CAUTION

The exclamation point inside an equilateral triangle is intended to alert the user to the presence of important operating and maintenance (servicing) instructions in the literature accompanying the product.



WARNING



Installation of all TV monitors must be out of the drivers field of vision.



Do not mount the product where it will obstruct the deployment of the airbag or in an area where it would affect the driver's ability to control the vehicle. Also be careful to avoid mounting the product where it can become hazardous during sudden stops or in the event of an accident.



Do not try and service these products yourself, locate a qualified service center or factory service center for all repairs.



Be careful not to drop or apply under pressure to the front panel of your video monitor. If the screen cracks due to misuse, your warranty will be void!



Use extra caution with any liquids in your car. If you or your child spills any liquid on these products, pull your vehicle to the roadside and turn the key off to disconnect or wipe the products with a towel. Do not operate the equipment until all liquids have either evaporated or you have had the monitor inspected at a service center by a qualified technician. Severe harm or danger can result.



Use only a damp cloth to clean the screen and use only purified water on the cloth. wring out all excess water prior to wiping the screen. Do not use any cleaners or chemicals to clean the screen. In most cases a dry cloth will do!

SPECIFICATIONS

Power	DC 12V
Screen Format	4:3
Resolution Pixel	2400x600
Color System	NTSC/PAL Auto Select
A/V Input	DVD-AV1-AV2
A/V Output	1 EA
Dimension	With shroud: 15.1(L)X13.9(W)X3.5(H)inches
Dimension	Without shroud: 14.8(L)X13.6(W)X2.5(H)inches

Note: This equipment has been tested and has been found to comply with the limits for a Class A digital device, pursuant to part 15 of the FCC Rules. These limits are designed to provide reasonable protection against harmful interference when the equipment is operated in a commercial environment. This equipment generates, uses, and can radiate radio frequency energy and, if not installed and used in accordance with the instruction manual, may cause harmful interference to radio communications. Operation of this equipment in a residential area is likely to cause harmful interference. In some cases, the user will be required to correct the interference at his own expense.

Troubleshooting

Symptom	Items to Check	Actions to be Taken
Buttons do not work.	Is the power turned on?	Check the car battery capacity.
No sound	Is the audio which is connected with the audio cable set to receive the DVD signal output? Is audio cable connected securely? Is the monitor which is connected with the audio cable turned on? Is the audio output set in the correct position?	Select the correct input mode for the audio receiver. Connect the audio cable into the jacks securely. Turn on the monitor connected with the audio cable. Set the Audio Output to the correct position, and then turn on the DVD player again by pressing the POWER button.
Remote control does not work properly.	Is the remote control facing the remote sensor? Is the distance too far? Is there any obstacle in the middle? Is the battery weak?	Point the remote control toward the remote sensor of the product. Use the remote control within 15 feet. Remove the obstacle. Replace with new battery.

Moisture or condensation on lens

When a disc is brought from a cold environment to a warm one, there may be moisture on the the disc, or condensation on the pickup lens. It will affect disc playback.

1. Remove the disc from the DVD player.
2. Turn on the power and leave it on for an hour to vaporize the condensation.

Caution

CAUTION



Quality installations are best performed by qualified and certified installers.



Watching the monitor for an extended period of time without the engine running may deplete the vehicle's battery charge.



Don't touch the unit if there is a flash of lightning. You may receive an electric shock.



This product is designed for operation with a 12 Volt DC, negative ground vehicle. It is not suitable for operation under other conditions or voltages.



Do not cover or stop up heater ducts or vents. It may cause a fire or receive an electric shock.



Do not bring magnetic devices such as credit card or magnetic card near the magnets.

Operating Notes

1. The operating temperature of this product is limited to 14°~+140°F.
2. If your vehicle is extremely hot or cold you must allow time for your air conditioner or heater to cool or heat the vehicle until operating temperatures have returned to normal operating ranges.
3. Optimal picture quality is achieved when viewed from directly front of the monitor (+/-30degrees).
4. Do not open the housing and attempt to make any repairs yourself. Refer servicing to qualified personnel.
5. DVD Players use an invisible laser beam which can cause hazardous radiation exposure. Be sure to operate the unit correctly as instructed.
6. Do not cut the car power supply off while a disc is playing. It can cause damage to the DVD Player.
7. If the buttons get stuck, please try to press the up of buttons, it will get back. It won't impact using normal.
8. If you can't find the files name in list when playing, please reset units or turn off/on over again.
9. If the unit can't be change mode when playing some special files which the unit didn't support, please reset units or turn off/on over again.

Features and Controls

Monitor/DVD Player



Remote Control

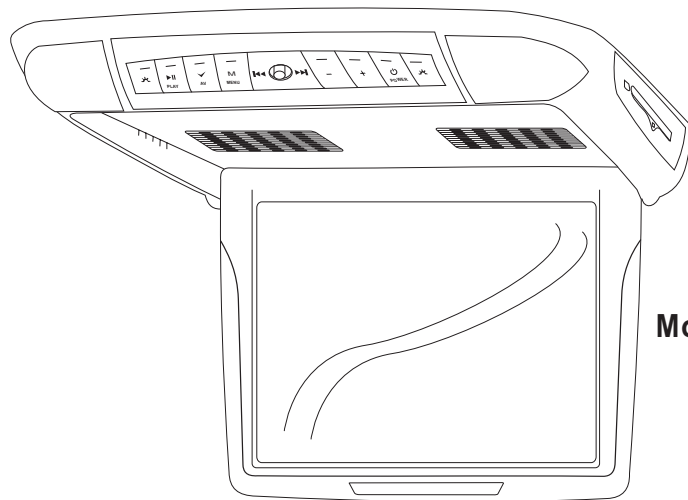

Monitor/DVD Player



Wireless Headphones
(Not Included)

Disc Information

DVD features

DVD discs provide high-resolution images with high-quality sound. This DVD player can play not only DVD discs of various versions, but also S-VCD, VCD, audio CD and MP3 discs.

Discs that cannot be played

DVD-RW, DVD-REM, CD-ROM, CD-EXTRA discs cannot be played on this unit. In addition, a CD or a CD-RW which was recorded on special software cannot be played.

Region code

Your DVD player is designed and manufactured to region management information that is recorded on a DVD disc. Please check the region code.

1: North America 2: Japan 3: Korea and Southeast Asia
4: Australia, Mid & South America 5: Russia 6: China

How to handle the disc

- Don't touch the shiny side of the disc (the side with the embedded information).
- Don't stick a label or a glue-based note on either side of the disc.
- Don't use discs that have glue or a damaged label with exposed adhesive residue. It might result in damage to your DVD player.
- Don't put discs in the sunshine.
- Park your car in the shade.



How to handle the discs

Only use round discs. Discs with other shapes like a star, a heart, etc. may cause damage to the player. If a disc is dirty, wipe softly with a wet cloth and then with a dry one. Before playback, wipe the disc outward from the center with a clean cloth. Do not use any type of solvent such as thinner, benzene, commercially available cleaners or antistatic spray. To avoid damaging your DVD player, don't use a scratched disc.

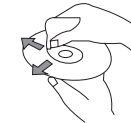

Installation

1. Open the package and check that these items are presents.

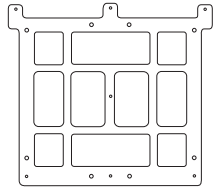

INSTALLATION PLATE



UNIT

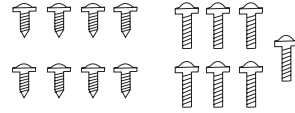

SCREW A

SCREW B

2. Connect the external compoments to the RCA cable or AV output.
(Refer to the connection diagram on page 33)

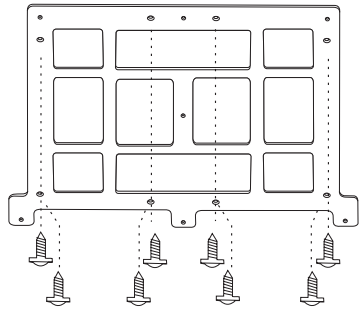

3. Match the position of installation bracket and installation plate with screw A.

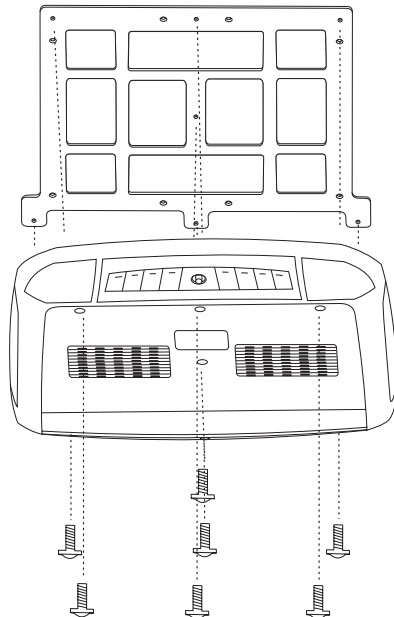

4. Tighten the unit with the supplied screw B.

Features and Controls

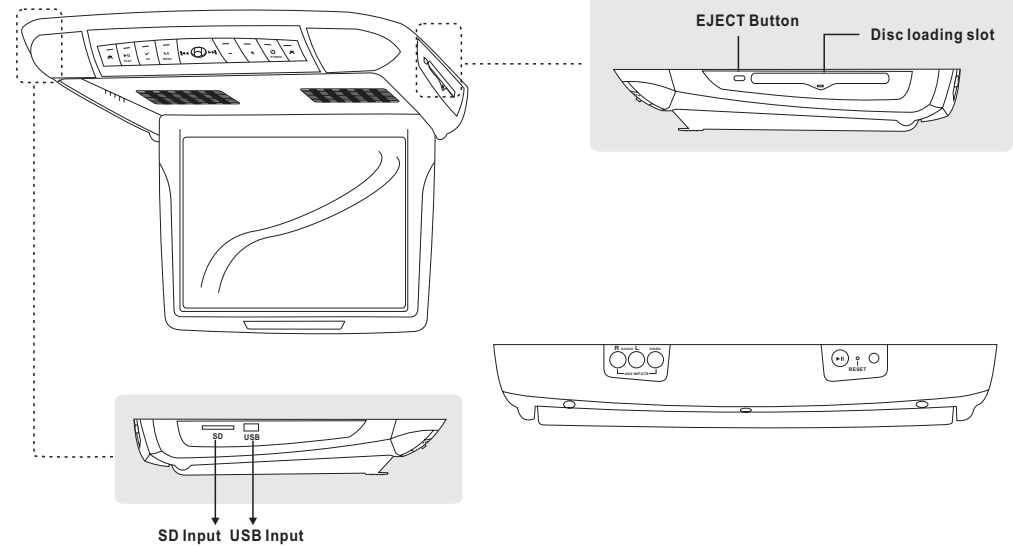
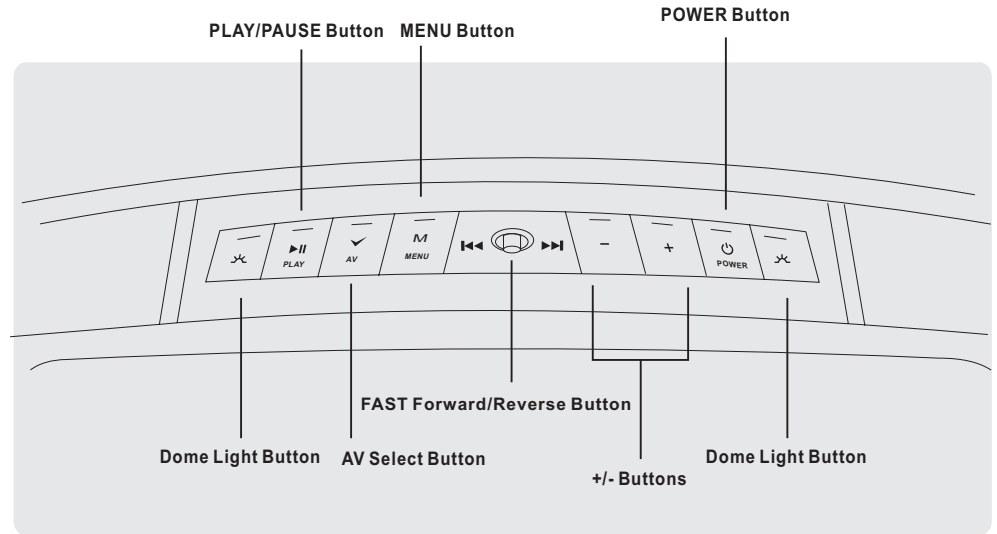

* Caution

Do not bring magnetic devices such as credit cards or magnetic cards near the monitor.

Features and Controls

Remote Control

- 1 **POWER**
Turns the DVD Player/Monitor on or off.
- 2 **MUTE**
Press this button to switch off the audio during playback. Press again to restore the audio.
- 3 **▶|| (not function in this unit)**
To start playback of iPod, press this button. Press again to pause the playback. If playback is paused, press this button to resume playback.
- 4 **VOL-/VOL+ (not function in this unit)**
Use to increase or decrease volume level.
RIGHT(◀◀)/LEFT(▶▶) ARROWS (not function in this unit)
Use these buttons (press once) to skip to the next or last track, chapter or file on the iPod in the player. But if you use these buttons (press continuous) to select either fast forward or fast reverse playback.
- 5 **AV SELECT**
DVD→AV1→AV2
- 6 **MENU (OSD on monitor)**
Press this button to open the on-screen menu system to setup and control various parameters of the monitor and DVD player.
- 7 **UP/DOWN**
Use to move to the desired menu.
- 8 **P/N**
This button permits you to choose among Multi, PAL and NTSC.
- 9 **MODE**
Use this button to switch between three modes
DVD→SD→USB
- 10 **MENU (DVD menu)**
This button permits you to view the menu on the DVD.
- 11 **SUBTITLE**
Use this button to select the menu for choosing a subtitle language.
- 12 **TITLE (Title menu)**
When a DVD is playing, press this button to view the Title Menu.
- 13 **DISPLAY**
Press to show elapsed or remaining time of a chapter or a title.
- 14 **PBC (Video CD only)**
Press this button to access the special Playback Control functions for VCD 2.0 format Video CD'S.
- 15 **NUMERIC button**
Use when making a selection on the menu screen.

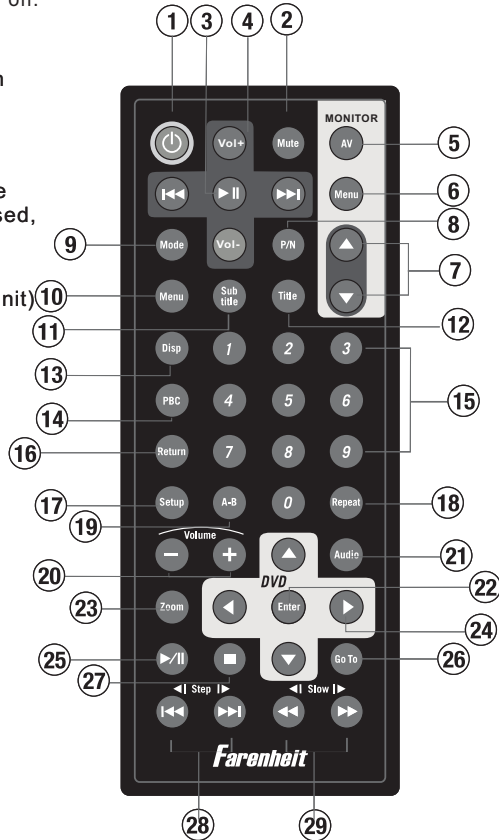

Connection Diagram

On a towel or soft cloth, gently place the monitor assembly "face down" on a stable work surface.

Using the wires provided, complete the audio, video and power connections in your vehicle as shown in the diagram below.

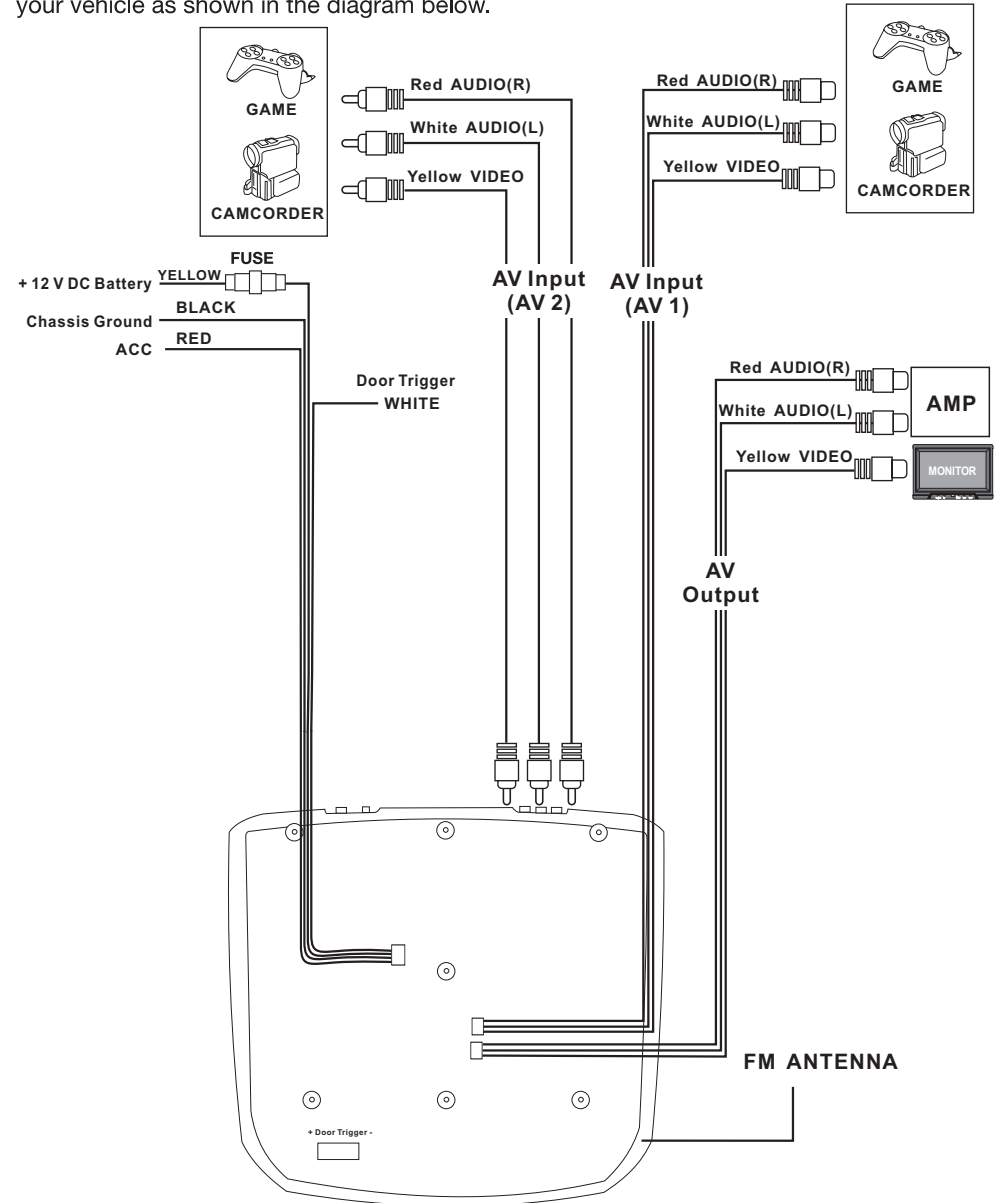

SD/USB Functions

1. When USB or SD is inputted, the monitor will be displayed as shown below. But when you input "USB" that the function can not change into SD's state (only the SD is moving). And you can select the desired menu by pressing the MODE button on the remote control of monitor.

2. Use the (arrow and ENTER) buttons to select and set desired settings.

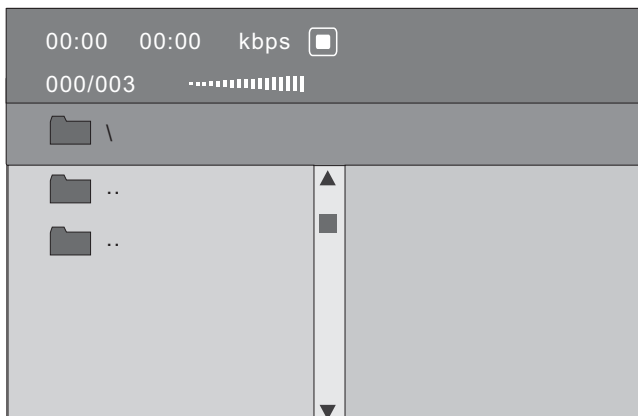

Features and Controls

- 16 RETURN**
Press this button to return to the root menu
- 17 SETUP**
Press this button to display the Setup menu. The Setup menu enables you to enter the settings required for the unit to work properly.
- 18 REPEAT**
Press this button to change the playback mode to repeat.
- 19 A-B (repeat from A to B)**
Use this button to select the beginning and end of a track which you wish to have repeat in playback.
- 20 VOL-/+ button**
Use to increase or decrease volume level.
- 21 AUDIO**
Use this button to select one of the audio soundtracks programmed on a DVD disc. It is also used to select the audio output mode for the DVD playback.
- 22 ENTER**
Press this button to confirm the item you have found and highlighted using the arrow buttons. Usually this is done to confirm a selection or item to be played on the DVD.
- 23 ZOOM**
If your DVD disc supports zooming in to see the program differently, pressing this button will enable you to change the amount of zoom.
- 24 UP/DOWN/RIGHT/LEFT ARROWS**
Use these buttons to navigate the various menus and screens for the monitor and DVD systems.
- 25 PLAY/PAUSE**
To start playback of a disc, press this button. Press again to pause the playback. If playback is paused, press this button to resume playback.
- 26 GO TO**
Use to search for a title or a chapter on your DVD disc.
- 27 STOP**
Press this button to stop the playback of the current disc.
- 28 SKIP FORWARD/BACK**
Use these buttons to skip to the next or last track, chapter or file on the disc in the player.
- 29 FAST FORWARD/REVERSE PLAY**
Use these buttons to select either fast forward or fast reverse playback.

Power and Mode Selection

Releasing The Monitor

Push the release button (located on the front edge of the screen housing) and lower the monitor. You can also adjust the swivel angle.

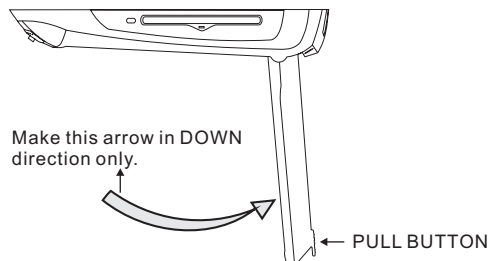

Turning on The Monitor

1. Connect the monitor to external devices.
2. Press the **POWER** button on either the remote control or the unit once to turn the power on.

Press the same **POWER** button to turn the power off.

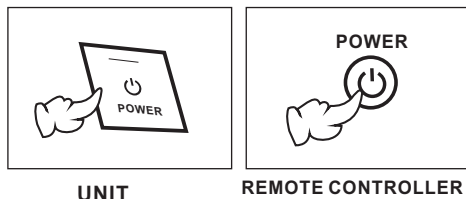

3. Power on the external devices and play.

Mute Function

1. Press the **MUTE** button on the remote control to mute the audio.
2. Press the **MUTE** button again on the remote control to return to the previous volume level.

DVD Functions

PBC

[DVD]/[AUDIO]/[MP3]

This button does not function in PBC mode.

[VCD]

You can turn the PBC (Play Back Control) function on or off by pressing this button. When PBC is loaded, the PBC function is enabled automatically. This function is similar to selection of DVD title. Please note that this function does not work with MP3 discs.

Zoom

[DVD]

Some DVDs are programmed to allow you to zoom into the image, magnifying it. Pressing the **ZOOM** button does this in steps, according to the chart to the right.

OSD	CONDITION
2 X	ZOOM X 2
3 X	ZOOM X 3
4 X	ZOOM X 4
1 / 2	ZOOM X 1 / 2
1 / 3	ZOOM X 1 / 3
1 / 4	ZOOM X 1 / 4
	Off

[VCD]/[AUDIO]/[MP3]

This button does not function in this mode.

GO TO

The **GO TO** function allows you to begin playback at a specific location on the disc. To do this, press **GO TO** and navigate the screen which follows to select this playback location.

Title

Move to the desired title.

Chapter

Move to the desired chapter.

Audio

Selects the desired audio output.

Subtitle

Select the desired subtitle.

Angle

Watch the different view angle.

TT Time

Total time.

CH Time

Chapter time.

Repeat

Sets the repeat play.

Time Display

Watch play time.

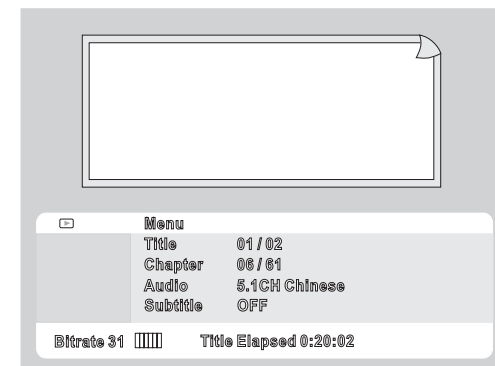

DVD Functions

Repeat

[DVD]

Pressing REPEAT button changes the play mode as follows:

OSD	CONDITION
↻ Chapter	Repeat chapter
↻ Title	Repeat title
↻ All	All
	Repeat off

[VCD] ∅

The REPEAT button does not function when a VCD disc is being played.

[AUDIO]

Pressing REPEAT button changes the play mode as follows:

OSD	CONDITION
Track	Repeat single
All	All
	Repeat off

[MP3]

Pressing REPEAT button changes the play mode as follows:

OSD	CONDITION
Repeat One	Single
Repeat Folder	Repeat folder
Folder	Repeat folder one time
Shuffle	All
Random	Random play
Single	Single play

NTSC/PAL

This button is used to select the video standard for the DVD mode between NTSC and PAL formats.

Angle

Some DVD's are recorded with additional footage which allows you to view a scene from a different camera angle. If the ANGLE feature is enabled in the Setup Menu (see page 14) and the disc has this option, an "angle mark" will be displayed on the screen. When that occurs, press the ANGLE button to see these alternate viewing angles.

Power and Mode Selection

Selecting an AV mode

1. Turn the power ON on the unit and on the external devices.
2. Select the DVD, AV1 or AV2 mode by pressing the AV Select button on the unit or on the remote control.
3. Play the external device.

Picture Control

Contrast/Brightness/Color/FM

To adjust CONTRAST, BRIGHTNESS, COLOR or FM press the MENU button until you arrive at the screen for that item. Use the arrow buttons to adjust the value. Press the MENU button to make another adjustment or leave the MENU system.

1. Bring up the on-screen function menu by pressing the MENU button on the unit or the remote control.
2. Press the MENU button on the unit or the remote control of monitor until you see the item you wish to adjust.
3. Use the arrow buttons to adjust the value.
4. Press the MENU button to make another adjustment or leave the MENU system.

CONTRAST



BRIGHTNESS



COLOR



FM

87.7 ►

(FM function added 87.7►87.9►88.1►88.3►88.5►
88.7►88.9►89.1MHz)

DVD Functions

Prev(◀◀)

[DVD]/[VCD]

Press this button to advance the player from the current chapter to the previous chapter.

[AUDIO]/[MP3]

Press this button to move to the previous track.

Next(▶▶)

[DVD]/[VCD]

Press this button to advance the player from the current chapter to the next chapter.

[AUDIO]/[MP3]

Press this button to move from the current track to the next track.

Repeat(A-B)

[DVD]/[VCD]/[AUDIO]

You can set the player to repeat a segment over and over until you cancel it. To do this, you mark the beginning of the desired segment (A) and the end of segment (B). The selected segment will be repeated automatically until canceled.

OSD	CONDITION
A	Start point of repeat
A B	Ending point repeat function

DVD Functions

Fast Reverse Searching(◀◀)

[DVD]

Pressing FR button repeatedly changes the play mode as follow:

OSD	CONDITION
FR 2X	2X rewind search
FR 4X	4X rewind search
FR 8X	8X rewind search
FR 16X	16X rewind search
FR 32X	32X rewind search
PLAY	Play

[AUDIO]

Pressing FR button repeatedly changes the play mode as follow:

OSD	CONDITION
FR 2X	2X rewind search
FR 4X	4X rewind search
FR 8X	8X rewind search
FR 16X	16X rewind search
FR 32X	32X rewind search
PLAY	Play

[MP3]

Pressing FR button repeatedly changes the play mode as follows:

OSD	CONDITION
FR 2X	2X rewind search
FR 4X	4X rewind search
FR 8X	8X rewind search
FR 16X	16X rewind search
FR 32X	32X rewind search
PLAY	Play

Fast Forward Searching(▶▶)

[DVD]

Pressing FF button repeatedly changes the play mode as follow:

OSD	CONDITION
FF 2X	2X forward search
FF 4X	4X forward search
FF 8X	8X forward search
FF 16X	16X forward search
FF 32X	32X forward search
PLAY	Play

[AUDIO]/[VCD]

Pressing FF button repeatedly changes the play mode as follow:

OSD	CONDITION
FF 2X	2X forward search
FF 4X	4X forward search
FF 8X	8X forward search
FF 16X	16X forward search
FF 32X	32X forwardsearch
PLAY	Play

[MP3]

Pressing FF button repeatedly changes the play mode as follows:

OSD	CONDITION
FF 2X	2X forward search
FF 4X	4X forward search
FF 8X	8X forward search
FF 16X	16X forward search
FF 32X	32X forwardsearch
PLAY	Play

DVD Setup

■ Setup Menu-Main Page

When the **SETUP** button is pressed, the setup menu will be displayed as shown below. Select the menu category and make changes according to your preferences.

1. Press the **STOP** button if the disc is playing.
2. Press the **SETUP** button to display setup menu.

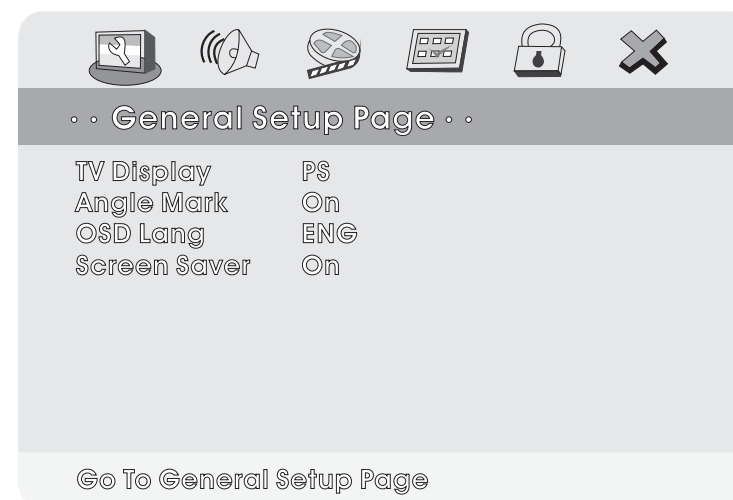

3. Use the (arrow and ENTER) buttons to select and set desired settings.
4. Press the **SETUP** button again to turn off the setup menu.

DVD Setup

General Setup

1. TV Aspect Ratio

In the Setup function called TV Display, you set the player to output the video signal at the same aspect ratio as your monitor. If the monitor is widescreen format, select "WIDE." If it is as "normal" screen (4:3), choose NORMAL/PS (Pan and Scan) or NORMAL L/B (Letterbox).



Normal / PS 4:3 PAN SCAN
Choose this setting if you want the movie to fill the entire screen. (This might mean that the left and right edges won't be seen)



Normal / LB 4:3
Choose this setting if you want to see the movie in its original aspect ratio. (The movie might appear with black bars at the top and bottom of the screen.)



Wide 16:9 WIDE SCREEN
Choose this setting if your DVD Player is connected to a widescreen TV. (This option is available only if the disc has a 16:9 display aspect ratio.)

2. Angle Viewing

Some DVD discs contain programming which allows you to view a scene from a few different camera angles. You can tell when a scene is so recorded when an "Angle Mark" is displayed on the screen. This mark will only appear if you have enabled the Angle Mark feature in the DVD Setup menu.

On: When selected, the screen will be shown with angle mark.

Off: When selected, no angle mark is shown on the screen.

3. OSD Language

Use this option to set the OSD language. When selected, change to set the on-screen display language.

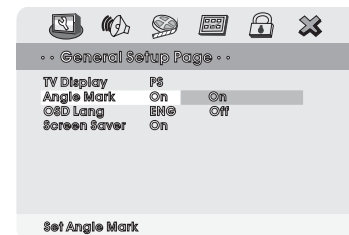
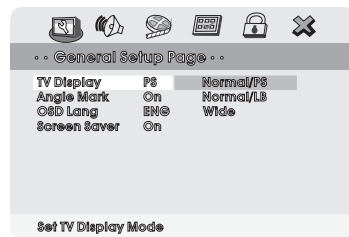

DVD Functions

Subtitle(SUB-T)

[DVD]

This button is used to select the language for the on-screen display system. (This title menu may vary, depending on the particular DVD.)

Title

[DVD]

Used to display the title menu of the loaded DVD disc. This function is only present on discs which support it.

Slow(▶)

[DVD]/[VCD]

Use this button to play a disc in slow-forward or slow-reverse. Slow playback can be done at five different speeds. Pressing this button repeatedly decreases the speed in steps. Pressing a sixth time returns playback to the normal speed.

OSD	CONDITION
▶ 1 / 2	2X slow forward
▶ 1 / 4	4X slow forward
▶ 1 / 8	8X slow forward
▶ 1 / 16	16X slow forward
▶ 1 / 32	32X slow forward
◀ 1 / 2	2X slow rewind
◀ 1 / 4	4X slow rewind
◀ 1 / 8	8X slow rewind
◀ 1 / 16	16X slow rewind
◀ 1 / 32	32X slow rewind
Play	Play

DVD Functions

Display

[DVD]

Pressing the DISPLAY button on the remote control changes the play mode as follows:

OSD	CONDITION
Title Elapsed	Display the Title Elapsed
Title Remain	Display the Title Remain
Chapter Elapsed	Display the Chapter Elapsed
Chapter Remain	Display the Chapter Remaining
Display Off	No sign

[AUDIO]

Pressing the display button displays information about the current CD on the screen as follows:

OSD	CONDITION
Single Elapsed	Display the single elapsed
Single Remain	Display the single remain
Total Elapsed	Display the total elapsed
Total Remain	Display the total remaining

[VCD]

Whenever press the button, title chapter will be displayed as follows:

OSD	CONDITION
Single Elapsed	Display time
Single Remain	Left display time
Display Off	No sign

[MP3]

Your DVD player will display the counter automatically when you play the MP3 disc.

Number Buttons

[DVD]

The 0 through 9 number buttons are used to enter the number of the track, the number of the DVD chapter, the time, the date, etc.

[AUDIO]

Select a track by pressing the corresponding number button.

OSD	CONDITION
Select Track: __	Select track no

[DVD]

You can select a track in the folder by pressing the corresponding number button.

OSD	CONDITION
__:__	Select track no

DVD Setup

4. Screen Saver

The screen saver is useful to prevent your display from becoming damaged. The screen saver picture appears when you leave the DVD player in stop mode for about two minutes.

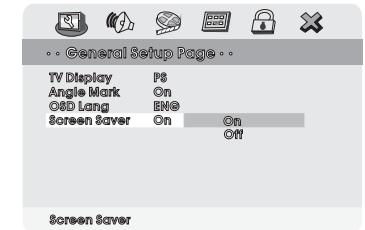

■ Audio Setup

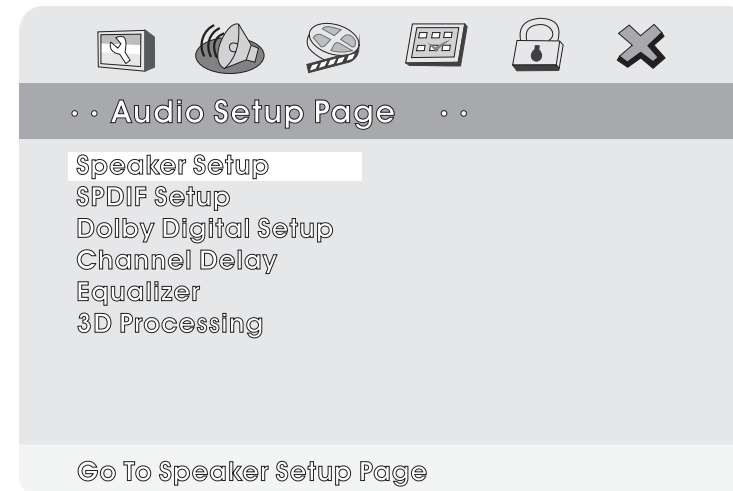

DVD Setup

Show below are two examples of Audio Setups.

1. Dolby Digital Setup

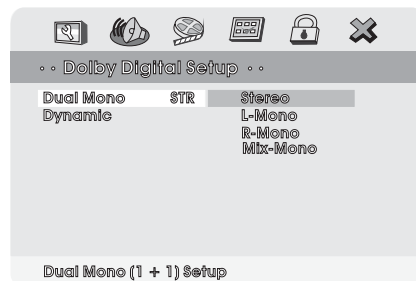
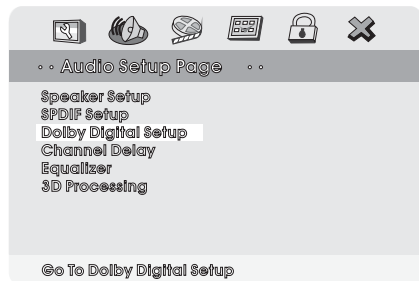

Dual Mono

Use this function to set the input audio signal to match your speaker setup.

Dynamic

Use this function to change the setting from the factory.

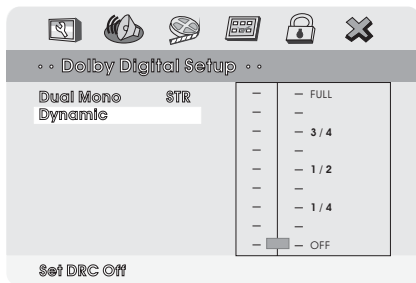
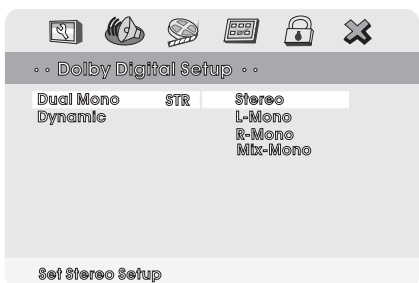

2. Equalizer Settings

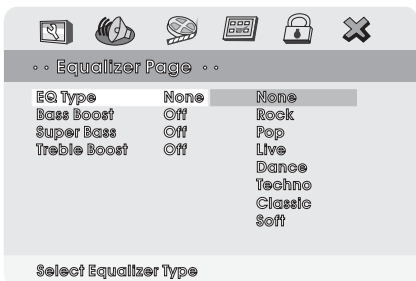
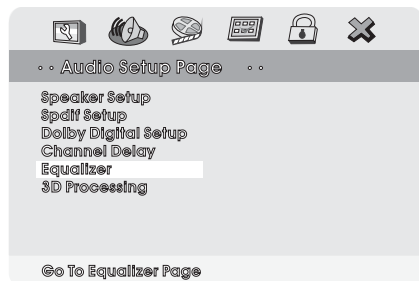

DVD Functions

Stop(■)

[DVD]/[AUDIO]

In DVD mode, Press STOP to stop playback. To resume playback, press PLAY/PAUSE. If you press STOP and then PLAY/PAUSE twice, the player will begin playback at the first scene of the movie.

OSD	CONDITION
1 Time Press Play Key To Continue	Stop
2 Time	Disc Stop

[MP3]

In MP3 mode, Pressing STOP will stop the audio playback. Press PLAY/PAUSE to begin playback of the first title on the disc.

OSD	CONDITION
1 Time Stop	Stop

Arrows(◀/▶/▲/▼)

[DVD]

In addition to navigating the various menus, you can use the arrow buttons to define the area of the screen you want to enlarge in ZOOM mode.

[MP3]

After pressing STOP button, select the desired folder and set the condition by pressing ENTER button.

Setup

Pressing the SETUP button opens the Setup Menu, where you can make and adjust DVD settings to suit your equipment and preferences.

Menu

[DVD]

Pressing the SETUP brings up the DVD disc menu. The content of this menu varies, depending on the programming of the disc.

DVD Functions

Eject

When this button is pressed, the disc is ejected. When this button is pressed for more than 3 seconds, the disc is unconditionally ejected. Use this function if you encounter difficulty ejecting a disc.

Vol+/Vol-

Use these buttons to adjust the audio output level of the speaker from 0 to 100.

Mute

Press MUTE to turn off the audio part of the currently playing program. Press it again to return the audio volume to the level at which you were last listening.

OSD	CONDITION
Mute	Mute
Mute off	Mute off

Play or Pause (▶||)

Whenever this button is pressed, the mode switches from pause to play or play to pause.

OSD	CONDITION
▶	Play Disc
	Pause

Audio

[DVD]

Change the audio output format. (Available only if the disc supports available audio type.)

OSD	CONDITION
1 / 2 : Ac3 2CH English	2 Channel
2 / 2 : Ac3 5.1CH English	5.1 Channel

[VCD]/[AUDIO]

Changes the audio output format. (Available only if the disc supports available audio type.)

OSD	CONDITION
Stereo	Stereo
Mono Left	Mono Left
Mono Right	Mono Right
Mix Mono	Mix Mono

[MP3] ⊗

An invalid button press.

DVD Setup

EQ Equalizer Type

In this menu you can choose the desired preset equalizer mode.

(Choose from Rock, Pop, Live, Dance, Techno, Classic or Soft)

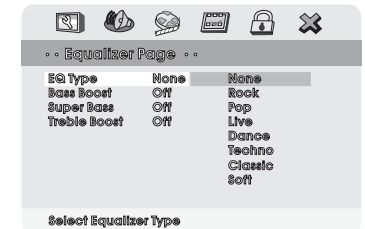

Bass Boost

The Bass Boost function increases the volume level of the bass frequencies.

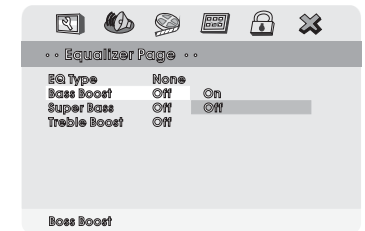

Super Bass

Super Bass Boost further increases the volume level of the bass frequencies.

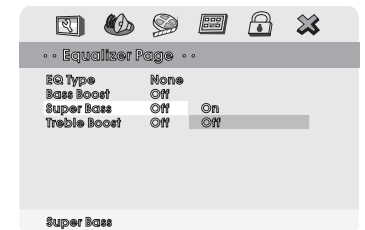

Treble Boost

Treble Boost increases the volume level of the upper frequencies.

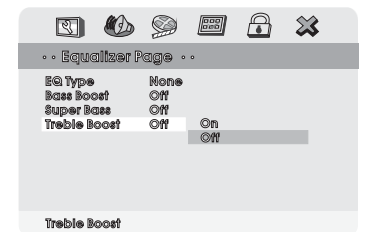

DVD Setup

5. Disc Menu

Use the Disc Menu option to select the display language for a DVD's disc menu display language. (not the same as the players menu)

1. Press the SETUP button during stop mode.
2. Press the ◀ / ▶ buttons to move to Preference.
3. Press the ▲ / ▼ buttons to move to Disc Menu.
4. Press the ENTER button.
5. Press the ▲ / ▼ buttons to select Disc Menu.

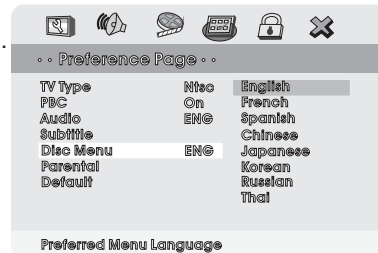

6. Parental

The Parental Control settings limit the player to only play content at or below a certain movie rating. The ratings systems in different countries vary. In the USA, the Motion Picture Association of America (MPAA) rates movies as G, PG, PG-13, etc. In this menu item, you can set what is the highest level of rating you wish to allow the unit to play.

1. Press the SETUP button when stop mode.
2. Press the ◀ / ▶ buttons to move to Preference.
3. Press the ▲ / ▼ buttons to move to Parental.
4. Press the ENTER button.
5. Press the ▲ / ▼ buttons to select desired parental level.

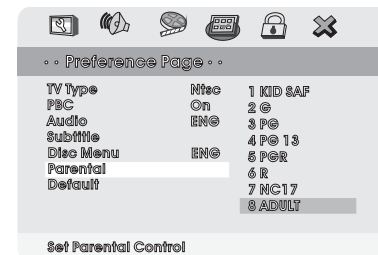

7. Default

If you select RESET when in the DEFAULT settings mode, all the settings of the Setup Menu will be returned to the factory default settings, except for Parental Level, Region and Password values.

1. Press the SETUP button when stop mode.
2. Press the ◀ / ▶ buttons to move to Preference.
3. Press the ▲ / ▼ buttons to move to Default.
4. Press the ENTER button to select Reset.

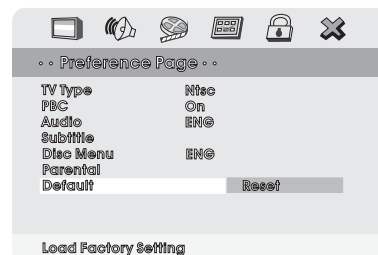

DVD Setup

Contrast

Use this option to adjust the contrast level.

Use the ▲ / ▼ buttons and press the ENTER button, when you reach the desired contrast level. The contrast control increases or decreases the ratio of bright and dark screen sections.

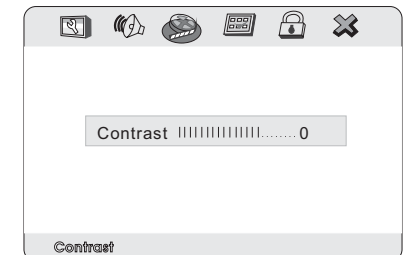

Gamma

In some systems, you might experience a loss in the strength of the dark sections of the displayed picture. This can be helped by changing the Gamma setting, which boosts the dark level but leaves the other levels unchanged.

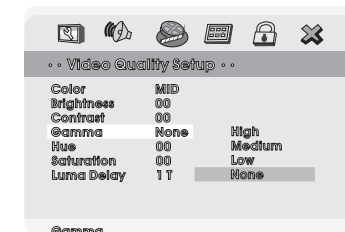

Hue

Select screen hue level using the direction ◀ / ▶ buttons and press the ENTER button.

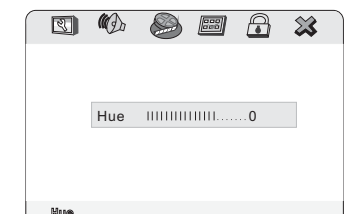
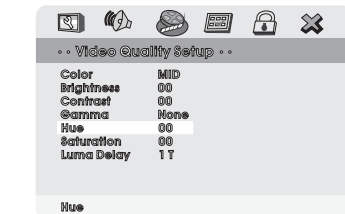

Saturation

Select screen saturation level using the direction ◀/▶ buttons and press the ENTER button.

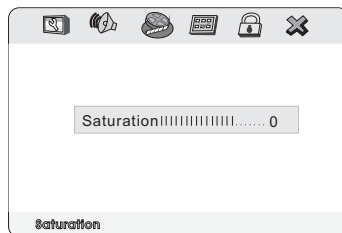

Luma Delay

Select the Luma Delay menu and select the preferred video image quality.

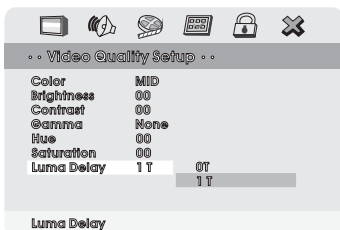

Preference

1. TV Type

Choose the proper TV format appropriate to the monitor you have connected to the player from the following: NTSC, PAL or Multi type.

1. Press the SETUP button during stop mode.
2. Press the ◀ / ▶ buttons to move to Preference.
3. Press the ▲ / ▼ buttons to move to TV Type.
4. Press the ENTER button.
5. Press the ▲ / ▼ buttons to select TV Type.

2. PBC (Play Back Control)

This feature is only available when a SVCD disc is loaded. It allows you to disable or enable the PBC (Play Back Control) menu of VCD discs.

1. Press the SETUP button during stop mode.
2. Press the ◀ / ▶ buttons to move to Preference.
3. Press the ▲ / ▼ buttons to move to PBC.
4. Press the ENTER button.
5. Press the ▲ / ▼ buttons to select TV Type On/Off.

3. Audio

Use the audio language menu to select the subtitle language that you prefer. If the disc you are playing has that language available, it will display subtitles in that language.

1. Press the SETUP button during stop mode.
2. Press the ◀ / ▶ buttons to move to Preference.
3. Press the ▲ / ▼ buttons to move to Audio.
4. Press the ENTER button.
5. Press the ▲ / ▼ buttons to select desired audio language.

4. Subtitle

In the Subtitle menu, you can select a subtitle language. Please note that subtitle will only appear in this language if the disc programming has included it.

1. Press the SETUP button during stop mode.
2. Press the ◀ / ▶ buttons to move to Preference.
3. Press the ▲ / ▼ buttons to move to Subtitle.
4. Press the ENTER button.
5. Press the ▲ / ▼ buttons to select desired subtitle.

