



Instruction Manual

EN-7517E / EN-7519E

17" and 19" Value TFT-LCD Monitor



Please read this manual thoroughly before use, and keep it handy for future reference.

CONTENTS

| | |
|---|--------|
| SAFETY INSTRUCTION..... | 2 - 3 |
| CAUTIONS | 4 |
| FCC RF INTERFERENCE STATEMENT | 5 |
| CONNECTING WITH EXTERNAL EQUIPMENT..... | 6 |
| REMOTE FUNCTIONS | 7 |
| CONTROLS AND FUNCTIONS..... | 8 - 20 |
| MOUNTING GUIDE | 21 |
| D-SUB CONNECTOR PIN ASSIGNMENTS | 22 |
| POWER MANAGEMENT..... | 23 |
| SPECIFICATIONS..... | 24 |
| TROUBLESHOOTING GUIDE..... | 25 |

This Monitor was
Manufactured by ISO 9001
Certified Factory

SAFETY INSTRUCTION

Important Safety Instruction

1. Read these instructions.
2. Keep these Instructions.
3. Heed all warnings.
4. Follow all instructions.
5. Do not use this apparatus near water.
6. Clean only with dry cloth.
7. Do not block any ventilation openings. Install in accordance with the manufacturer's instructions..
8. Do not install near any heat sources such as radiators, heat registers, stoves, or other apparatus (including amplifiers) that produce heat.
9. Do not defeat the safety purpose of the polarized or grounding-type plug.
Apolarized plug has two blades with one wider than the other.
Agrounding type plug has two blades and a third grounding prong.
The wide blade or the third prong are provided for your safety.
If the provided plug does not fit into your outlet, consult an electrician for replacement of the obsolete outlet.
10. Protect the power cord from being walked on or pinched particularly at plugs, convenience receptacles and the point where they exit from the apparatus.
11. Only use attachment/accessories specified by the manufacturer.
12. Use only with the cart, stand, tripod, bracket or table specified by the manufacturer or sold with the apparatus. When a cart is used, use caution when moving .. the cart/apparatus combination to avoid injury from tip-over.
13. Unplug this apparatus during lightning storms or when unused for long periods of time.
14. Refer all servicing to qualified service personnel. Servicing is required when the apparatus has been damaged in any way, such as power-supply cord or plug is damaged, liquid has been spilled or objects have fallen into the apparatus the apparatus has been exposed to rain or moisture does not operate normally or has been dropped.



SAFETY INSTRUCTION

“WARNING - To reduce the risk of fire or electric shock, do not expose the apparatus to rain or moisture.”

“The apparatus shall not be exposed to dripping or splashing and no objects filled with liquids, such as vases, shall be placed on the apparatus.”

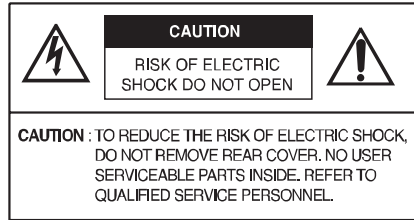

This symbol is intended to alert the user to the presence of uninsulated : dangerous voltage” with in the product’s enclosure that may be of sufficient magnitude to constitute arisk of electric shock to persons.



This symbol is intended to alert the user to the presence of important operating and maintenance(servicing) instructions in the literature accompanying the appliance.

CAUTIONS

CAUTION

The power supply cord is used as the main disconnect device, ensure that the socket-outlet is located/installed near the equipment and is easily accessible.

ATTENTION

Le cordon d'alimentation est utilisé comme interrupteur général. La prise de courant doit être située ou installée à proximité du matériel et être facile d'accès

CAUTION TO SERVICE PERSONNEL

POWER SUPPLY CORD IS USED AS MAIN POWER DISCONNECT DEVICE IN THIS PRODUCT. UNPLUG THIS PRODUCT FROM THE WALL OUTLET BEFORE REMOVING THE BACK COVER AND SERVICING

▶ NEVER REMOVE THE BACK COVER

Removal of the back cover should be carried out only by qualified personnel.

▶ DO NOT USE IN HOSTILE ENVIRONMENTS

To prevent shock or fire hazard, do not expose the unit to rain or moisture.

This unit is designed to be used in the office or home. Do not subject the unit to vibrations, dust or corrosive gases.

▶ KEEP IN A WELL VENTILATED PLACE

Ventilation holes are provided on the cabinet to prevent the temperature from rising.

Do not cover the unit or place anything on the top of unit.

▶ AVOID HEAT

Avoid placing the unit in direct sunshine or near a heating appliance.

▶ TO ELIMINATE EYE FATIGUE

Do not use the unit against a bright background and where sunlight or other light sources will shine directly on the monitor.

▶ BE CAREFUL OF HEAVY OBJECT

Neither the monitor itself nor any other heavy object should rest on the power cord.

Damage to a power cord can cause fire or electrical shock.

FCC RF INTERFERENCE STATEMENT

NOTE

This equipment has been tested and found to comply with the limits for a Class B digital device, pursuant to Part 15 of the FCC Rules. These limits are designed to provide reasonable protection against harmful interference in a residential installation.

This equipment generates, uses and can radiate radio frequency energy and, if not installed and used in accordance with the instructions, may cause harmful interference to radio communications. However, there is no guarantee that interference will not occur in a particular installation.

If this equipment does cause harmful interference to radio or television reception which can be determined by turning the equipment off and on, the user is encouraged to try to correct the interference by one or more of the following measures.

- Reorient or relocate the receiving antenna.
- Increase the separation between the equipment and receiver.
- Connect the equipment into an outlet on a circuit different from that to which the receiver is connected.
- Consult the dealer or an experienced radio, TV technician for help.
- Only shielded interface cable should be used.

Finally, any changes or modifications to the equipment by the user not expressly approved by the grantee or manufacturer could void the users authority to operate such equipment.

► DOC COMPLIANCE NOTICE

This digital apparatus does not exceed the Class B limits for radio noise emissions from digital apparatus set out in the radio interference regulation of Canadian Department of communications.

CONNECTING WITH EXTERNAL EQUIPMENT

A. BOTTOM PANEL CONTROL

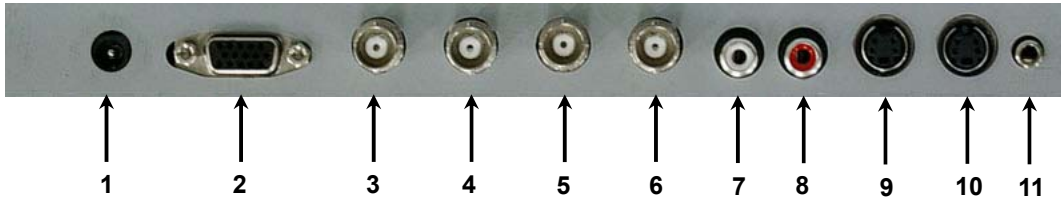

1. DC 12V IN

2. D-SUB IN

PC Signal Input

3. VIDEO 1(AV1) IN

Composite signal Input for AV1

4. VIDEO 1(AV1) OUT

Video looping output for AV1

5. VIDEO 2(AV2) IN

Composite signal Input for AV2

6. VIDEO 2(AV2) OUT

Video looping output for AV2

7. 8 AUDIO IN (L+R)

Stereo Audio Signal Input

9. S-VIDEO (Y/C) IN

Y/C separated signal input

10. S-VIDEO (Y/C) OUT

Y/C separated signal looping output

11. PC STEREO IN

REMOTE FUNCTIONS

B. REMOTE CONTROLLER

1. POWER(⏻)

Turns the power ON or OFF. There will be a few seconds delay before the display appears.

2. SOURCE

Select pc or video(AV1 / AV2 / S-Video / PC) sources.

3. APC (Auto Picture Control)

Select picture mode.

4. ACC (Auto Colour Control)

Select Colour mode.

5. AV1

Select AV1 mode

6. AV2

Select AV2 mode

7. S-VIDEO

Select S-VIDEO mode

8. PC

Select PC mode

9. AUTO

Auto geometry adjustment in PC Source.

10. MUTE

Mute the sound.

11. MENU

Activates and exits the On Screen Display.

12. EXIT

Exit the On Screen Display.

13. VOL(◀▶)

Increases or decreases the level of audio volume.

14. UP/DOWN

Move to OSD menu.

15. ENTER

Accepts your selection or displays the current mode.

16. INFO

Input mode information Display.

17. STILL

Pause the picture.

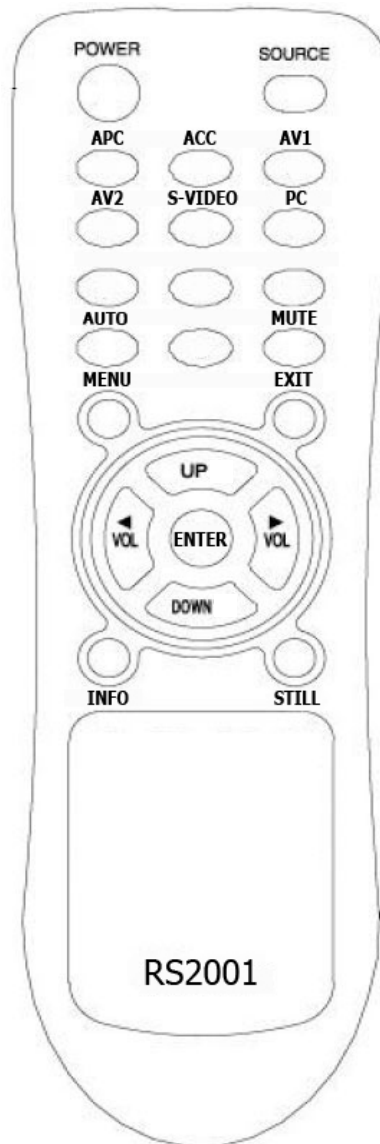

CONTROLS AND FUNCTIONS

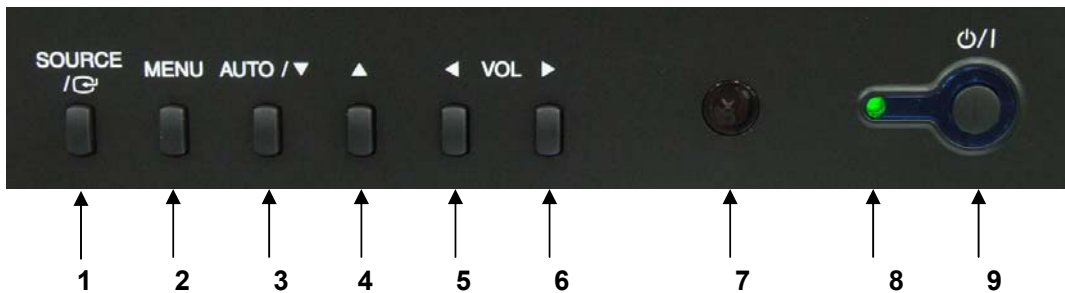

1. SOURCE

Select input source, and move the previous menu.

2. MENU

Activates and exits the On Screen Display.

This button can also be used to move previous menu or status.

OSD MENU(MAIN) : Custom, Picture/Sound, Setup

3/4. AUTO/▼ / ▲

This button allows user to enter the sub-menu of the activated function

AUTO: Auto geometry adjustment in PC Source.

5/6. □ VOL □

Adjust the volume / Adjust menu settings.

7. IR Sensor

Remote controller sensor.

8. POWER ON/OFF()

Turns the power ON or OFF. There will be a few seconds delay before the display appears.

The power LED(next to the power switch) lights with green when the power is turned ON.

The power is turned off by pressing the power switch again and the power LED goes Red.

CONTROLS AND FUNCTIONS

OSD MENU DESCRIPTION

A: CUSTOM MENU (Only Video mode)

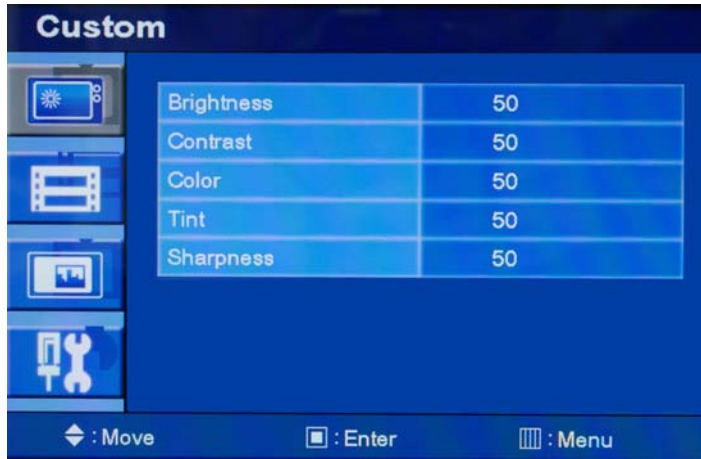

Press the MENU button and then up(▲) / down(▼) button to select the Custom menu.



Press the up(▲) / down(▼) button to select Custom sub menu.

Press the left(◀) / right(▶) button to adjust picture setting.

Press the MENU button to save.

Brightness: Increase or decrease the intensity of the image.

Contrast: Increase or decrease the intensity (lightness or dimness) of the image.

Color: Increase or decrease the colour of the picture.

Tint: Increase or decrease the tint of the picture.

Sharpness: Increase or decrease the sharpness of the picture.

CONTROLS AND FUNCTIONS

A: CUSTOM MENU (Only PC mode)



Press the MENU button and then up(▲) / down(▼) button to select the Custom menu.



Press the up(▲) / down(▼) button to select Custom sub menu.

Press (◀) / right(▶) button to adjust picture setting.

Press the MENU button to save.

CONTROLS AND FUNCTIONS

B. Picture / Sound Menu(Only Video mode)

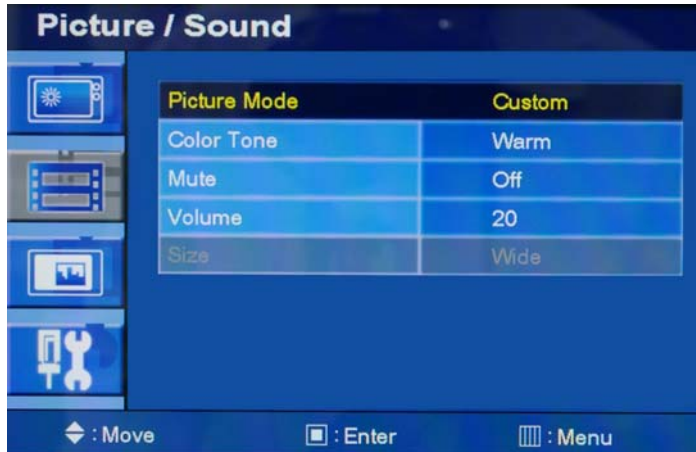

Press the MENU button and then up(▲) / down(▼) button to select the Picture / Sound.
Press the right(▶) or ENTER button.

1. Picture Mode



Press the up(▲) / down(▼) button to select the Picture Mode.
Press the right(▶) or ENTER button and then press up(▲) / down(▼) button to select the desired Picture Mode.
Press the MENU button to save.

CONTROLS AND FUNCTIONS

2. Color Tone

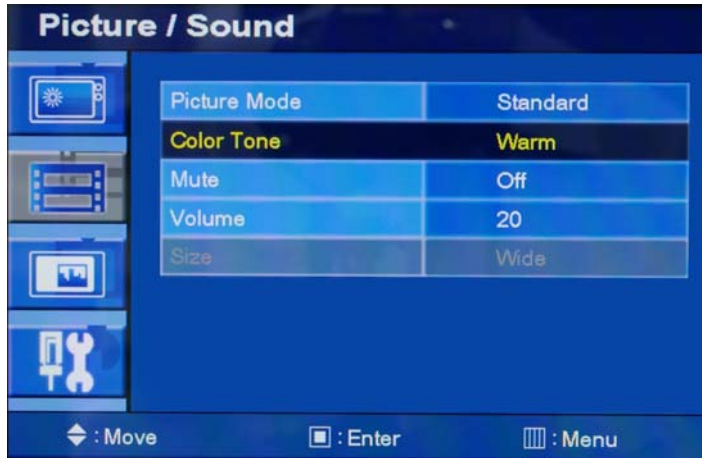

Press the up(▲) / down(▼) button to select the Color Tone.

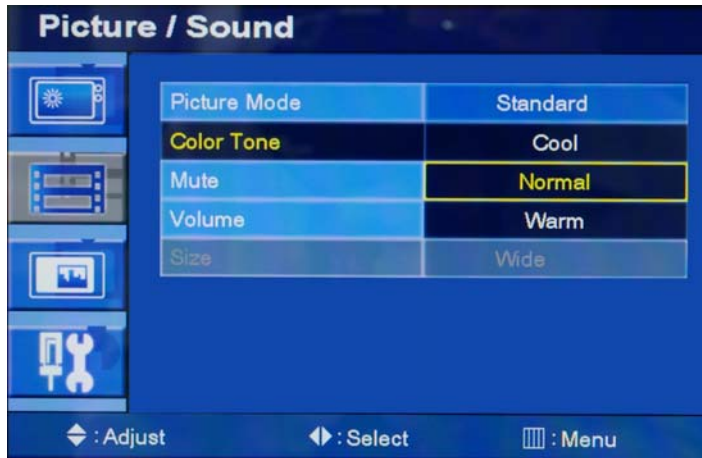

Press the (▶) or ENTER button and then up(▲)/down(▼) button to select the desired color tone.

Press the MENU button to save.

CONTROLS AND FUNCTIONS

3. Mute

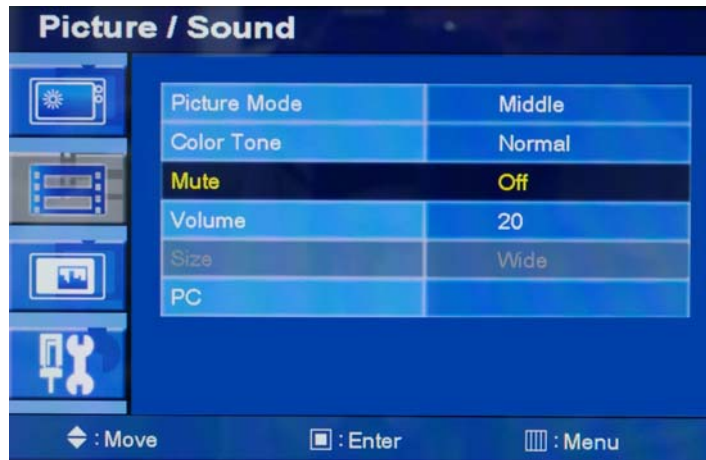

Press the up(▲) / down(▼) button to select the Mute.

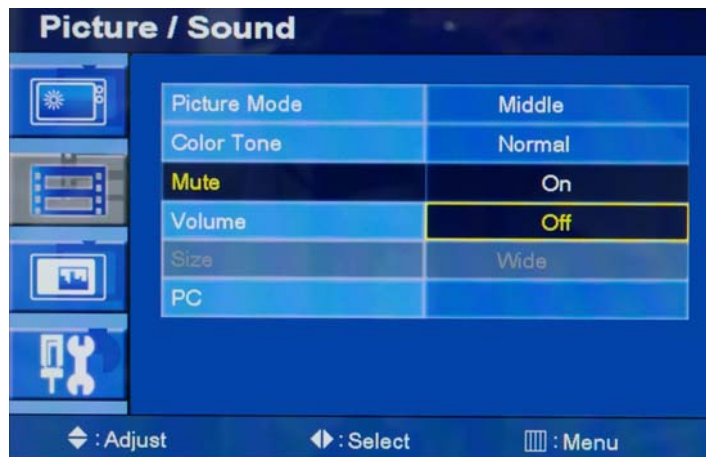

Press the (▶) or ENTER button and then up(▲)/down(▼) button to select the desired Mute.

Press the MENU button to save.

CONTROLS AND FUNCTIONS

4. Volume

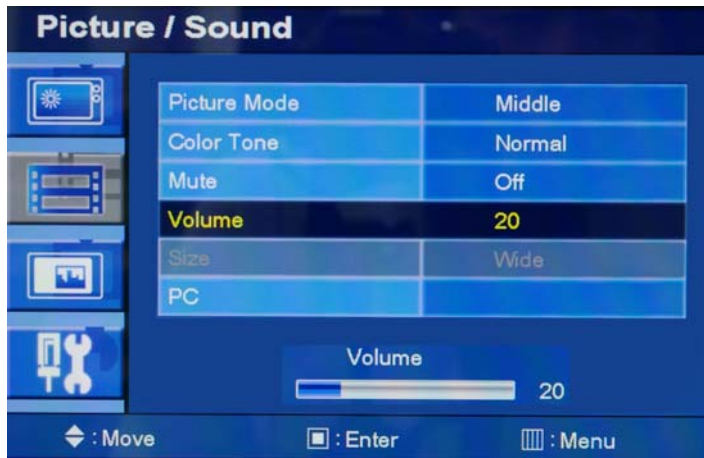

Press the up(▲) / down(▼) button to select the Volume.

Press the (◀) /right(▶) button to adjust Volume.

Press the MENU button to save.

5. PC (Only PC mode)

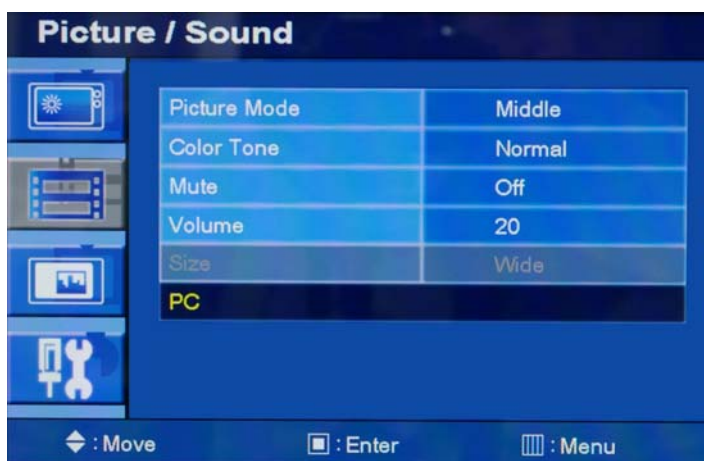

Press the up(▲) / down(▼) button to select the PC

Press the ▶ or ENTER button

CONTROLS AND FUNCTIONS

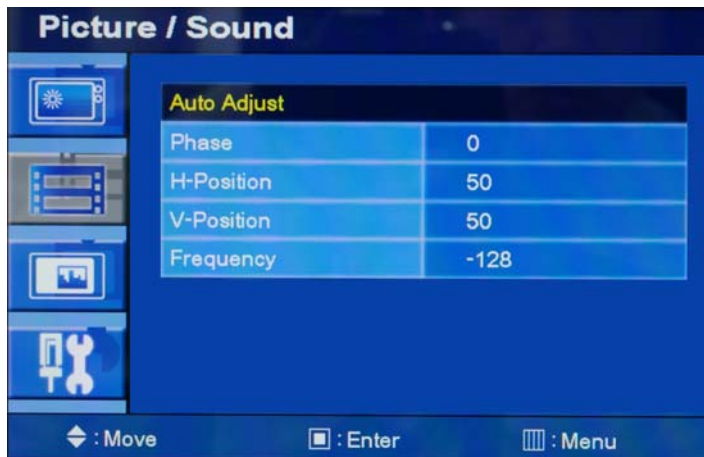

Press the up(▲) / down(▼) button to select PC sub menu

Press the right(▶) or ENTER button and then left (◀) /right(▶) button to adjust PC setting.

Press the MENU button to save.

Auto Adjust: Auto geometry adjustment

Phase: Adjust the number of horizontal picture elements.

H. position: Move image horizontally on screen right or left.

V. position: Move image vertically on screen up or down.

Frequency: Adjust the vertical noise of screen image.

C. SETUP MENU



Press the MENU button and then up(▲) / down(▼) button to select the Setup menu.

Press the right(▶) or ENTER button.

CONTROLS AND FUNCTIONS

1.Reset



Press ENTER button to select the reset

Reset: Select to reset all setting to the factory default values.

CONTROLS AND FUNCTIONS

2. Language



Press the up(▲) / down(▼) button to select the Language menu.
 Press the right(▶) or ENTER button.



Press the up(▲) / down(▼) button to select language.
 Press the MENU button to save.

CONTROLS AND FUNCTIONS

3. OSD Tone



Press the up(▲) / down(▼) button to select the OSD tone menu.

Press the right(▶) or ENTER button



Press the up(▲) / down(▼) button to select the desire OSD Tone.

Press the MENU button to save.

CONTROLS AND FUNCTIONS

4. Blue Screen



Press the up(▲) / down(▼) button to select the blue screen.

Press the right(▶) or ENTER button.



Press the up(▲) / down(▼) button to select on or off.

Press the MENU button to save.

CONTROLS AND FUNCTIONS

5. Key Lock



Press the up(▲) / down(▼) button to select the key lock menu.

Press the right(▶) or ENTER button



Press the up(▲) / down(▼) button select on or off

Press the MENU button to save.

MOUNTING GUIDE

Wall mountable using two methods:

- 1) Using the 200 mm pre-cut holes
- 2) Using the VESA standard wall mount design and the 100mm hole pattern on the back panel to install the LCD monitor to the wall.

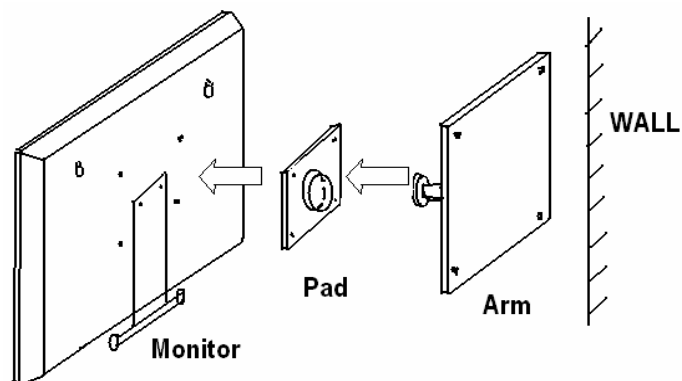
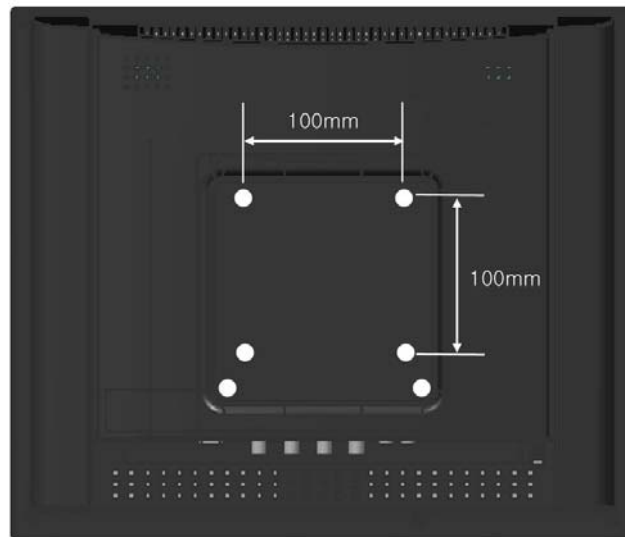

D-SUB CONNECTOR PIN ASSIGNMENTS

► PIN ASSIGNMENTS

| | | | |
|-------|--------------|----|-----------------------|
| Pin 1 | RED VIDEO | 9 | |
| 2 | GREEN VIDEO | 10 | SIGNAL CABLE DETECT |
| 3 | BLUE VIDEO | 11 | GROUND |
| 4 | GROUND | 12 | SDA(for DDC) |
| 5 | GROUND | 13 | H-SYNC.(or H+V SYNC.) |
| 6 | RED GROUND | 14 | V-SYNC. |
| 7 | GREEN GROUND | 15 | SCL(for DDC) |
| 8 | BLUE GROUND | | |

D-SUB

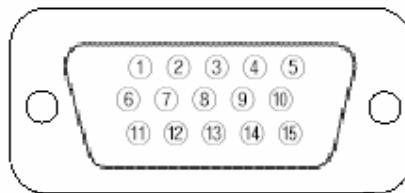

► ACCESSORY

1. POWER CORD
2. USER'S MANUAL
3. PC cable
4. Adaptor
5. Remote Control
6. Batteries
7. Wall mount (Option)
8. Rack mount (Option)

POWER MANAGEMENT

This monitor features a power management system to “power down” upon receipt of the VESA DPMS(The display power management signaling) from a VESA DPMS video card. The VESA DPMS-compliant video card performs this signaling system through not sending horizontal, vertical, or sync signal.

This monitor enters an appropriate mode through identifying each of the three modes of the signaling system.

POWER CONSUMPTION

| MODE | POWER CONSUMPTION |
|-----------|-------------------|
| ON | < 50W |
| STANDBY | < 11W |
| SUSPEND | < 11W |
| ACTIV OFF | < 8.5W |

LED INDICATOR

The power management feature of the monitor is comprised of four stages: On(Green), Standby, Suspend, Active off(Green on/off 1 sec) and Unsupported mode(Green).

| MODE | LED COLOR | MONITOR OPERATION |
|---------------------|--------------------------|--|
| ON | GREEN | Normal Operation |
| STANDBY | GREEN ON/OFF 1 SEC | Screen blanks after preset idle time And some electronic circuits or all Circuitry in the monitor shut down. |
| SUSPEND | | |
| ACTIV OFF | | |
| UNSUPPORTES MODE | GREEN | Normal operation but the on screen Display will show error message |
| POWER OFF | GREEN OFF | Not Operation |

SPECIFICATIONS

| | 17" | 19" |
|--------------------------------------|---|--|
| LCD- Type | 17" Diagonal AM-TFT(Active-Matrix) | 19" Diagonal AM-TFT(Active-Matrix) |
| | Pixel pitch(mm) : 0.264(H) x 0.264(V) | Pixel pitch(mm) : 0.294(H) x 0.294(V) |
| | BRIGHTNESS: 300cd/m ² (Typical) | BRIGHTNESS: 300cd/m ² (Typical) |
| | CONTRAST RATIO: 1000:1(Typical) | CONTRAST RATIO: 800:1(Typical) |
| | RESPONSE TIME: 5msec(Typical) | RESPONSE TIME: 5msec(Typical) |
| RESOLUTION (H x V) | 1280X1024 @60Hz | |
| FREQUENCY | HORIZONTAL: 31- 64KHz VERTICAL: 56-75Hz | |
| INPUT SIGNAL | VIDEO(2ch input 1.0Vp-p, 75Ω terminated, loop-through out) | |
| | SYNC(Separate TTL Level) | |
| | S-VIDEO(1ch input (Y/C) , loop-through out) | |
| | AV(composite) Sound in | |
| | PC Stereo Sound | |
| ACTIVE DISPLAY AREA (W x H) | 337.9 mm X 270.3 mm | 376.32mm X 301mm |
| PACKING DIMENSIONS (W x D x H) | 436mm X 476mm X 225mm | 490mm X 506mm X 225mm |
| WEIGHT | Net Weight : 6.2Kg | Net Weight : 6.61Kg |
| | Gross Weight : 7.8Kg | Gross Weight : 8.43Kg |
| ELECTRICAL RATINGS | DC 12V/ 3A | DC 12V/ 3.5A |

►► NOTE :

Technical specifications are subject to change without notice.

TROUBLESHOOTING GUIDE

| TROUBLE | TROUBLESHOOTING TIP |
|--|---|
| No image on display screen | <ol style="list-style-type: none"> 1. Check that power cord of the Monitor have been connected securely into wall outlet or grounded extension cable or strip. 2. Power switch should be in the ON position and LED is lit. 3. Check that the Brightness and/or the Contrast adjustments of the Display have not been turned down to minimum levels. |
| “Going to Sleep” message on screen | <ol style="list-style-type: none"> 1. The signal cable should be completely connected to the video card/computer. 2. The video card should be completely seated in its slot and the computer is switched ON. |
| Display image is not centered, too small or too large in PC mode | Push the down key in front side or Auto key in remoon. |
| Vertical or Horizontal noise is present in the picture | Adjust Clock and Phase in the OSD. |

WEEE Symbols

Correct Disposal of This Product (Waste Electrical & Electronic Equipment)

(Applicable in the European Union and other European countries with separate collection systems)

This marking shown on the product or its literature, indicates that it should not be disposed with other household wastes at the end of its working life. To prevent possible harm to the environment or human health from uncontrolled waste disposal, please separate this from other types of wastes and recycle it responsibly to promote the sustainable reuse of material resources. Household users should contact either the retailer where they purchased this product, or their local government office, for details of where and how they can take this item for environmentally safe recycling. Business users should contact their supplier and check the terms and conditions of the purchase contract. This product should not be mixed with other commercial wastes for disposal.



EverFocus Electronics Corp.

Taiwan - Headquarter Office

12F, No.79 Sec.1 Shin-Tai Wu Road,
Hsi-Chi, Taipei, Taiwan
Tel: +886-2-26982334
Fax: +886-2-26982380

China - Beijing Office

Room 609, Technology Trade Building.
Shangdi Information Industry Base,
Haidian District, Beijing China
Tel: +86-10-62971096
Fax: +86-10-62971423

Europe - Germany Office

Albert-Einstein-Strasse 1,
D-46446 Emmerich, Germany
Tel: +49-2822-9394-0
Fax: +49-2822-939495

Japan Office

1809 WBG Marive East 18F,
2-6 Nakase, Mihama-ku,
Chiba City 261-7118, Japan
Tel: +81-43-212-8188
Fax: +81-43-297-0081

USA - California Office

1801 Highland Ave. Unit A
Duarte, CA 91010 ,U.S.A
Tel: +1-626-844-8888
Fax: +1-626-844-8838

USA - New York Office

415 Oser Ave Unit S
Hauppauge, NY 11788
Sales: +1-631-436-5070
Fax: +1-631-436-5027

| | | |
|---|--|---|
|  | <p>Your EverFocus product is designed and manufactured with high quality materials and components which can be recycled and reused.</p> <p>This symbol means that electrical and electronic equipment, at their end-of-life, should be disposed of separately from your household waste.</p> <p>Please, dispose of this equipment at your local community waste collection/recycling centre.</p> <p>In the European Union there are separate collection systems for used electrical and electronic product.</p> <p>Please, help us to conserve the environment we live in!</p> | <p>Ihr EverFocus Produkt wurde entwickelt und hergestellt mit qualitativ hochwertigen Materialien und Komponenten, die recycelt und wieder verwendet werden können.</p> <p>Dieses Symbol bedeutet, dass elektrische und elektronische Geräte am Ende ihrer Nutzungsdauer vom Hausmüll getrennt entsorgt werden sollen.</p> <p>Bitte entsorgen Sie dieses Gerät bei Ihrer örtlichen kommunalen Sammelstelle oder im Recycling Centre.</p> <p>Helfen Sie uns bitte, die Umwelt zu erhalten, in der wir leben!</p> |
|---|--|---|

